

ZyWALL 2 Plus

Internet Security Appliance

User's Guide

Version 4.01

9/2006

Edition 1



About This User's Guide

Intended Audience

This manual is intended for people who want to configure the ZyWALL using the web configurator. You should have at least a basic knowledge of TCP/IP networking concepts and topology.

Related Documentation

- Quick Start Guide
The Quick Start Guide is designed to help you get up and running right away. It contains information on setting up your network and configuring for Internet access.
- Web Configurator Online Help
Embedded web help for descriptions of individual screens and supplementary information.



It is recommended you use the web configurator to configure the ZyWALL.

- Supporting Disk
Refer to the included CD for support documents.
- ZyXEL Web Site
Please refer to www.zyxel.com for additional support documentation and product certifications.

User Guide Feedback

Help us help you. Send all User Guide-related comments, questions or suggestions for improvement to the following address, or use e-mail instead. Thank you!

The Technical Writing Team,
ZyXEL Communications Corp.,
6 Innovation Road II,
Science-Based Industrial Park,
Hsinchu, 300, Taiwan.

E-mail: techwriters@zyxel.com.tw

Document Conventions

Warnings and Notes

These are how warnings and notes are shown in this User's Guide.



Warnings tell you about things that could harm you or your device.











Notes tell you other important information (for example, other things you may need to configure or helpful tips) or recommendations.

Syntax Conventions

- The ZyWALL 2 Plus may be referred to as the “ZyWALL”, the “device” or the “system” in this User's Guide.
- Product labels, screen names, field labels and field choices are all in **bold** font.
- A key stroke is denoted by square brackets and uppercase text, for example, [ENTER] means the “enter” or “return” key on your keyboard.
- “Enter” means for you to type one or more characters and then press the [ENTER] key. “Select” or “choose” means for you to use one of the predefined choices.
- A right angle bracket (>) within a screen name denotes a mouse click. For example, **Maintenance > Log > Log Setting** means you first click **Maintenance** in the navigation panel, then the **Log** sub menu and finally the **Log Setting** tab to get to that screen.
- Units of measurement may denote the “metric” value or the “scientific” value. For example, “k” for kilo may denote “1000” or “1024”, “M” for mega may denote “1000000” or “1048576” and so on.
- “e.g.” is a shorthand for “for instance”, and “i.e.” means “that is” or “in other words”.

Icons Used in Figures

Figures in this User's Guide may use the following generic icons. The ZyWALL icon is not an exact representation of your device.

ZyWALL 	Computer 	Notebook computer 
Server 	DSLAM 	Firewall 
Telephone 	Switch 	Router 

Safety Warnings



For your safety, be sure to read and follow all warning notices and instructions.

- Do NOT use this product near water, for example, in a wet basement or near a swimming pool.
- Do NOT expose your device to dampness, dust or corrosive liquids.
- Do NOT store things on the device.
- Do NOT install, use, or service this device during a thunderstorm. There is a remote risk of electric shock from lightning.
- Connect ONLY suitable accessories to the device.
- Do NOT open the device or unit. Opening or removing covers can expose you to dangerous high voltage points or other risks. ONLY qualified service personnel should service or disassemble this device. Please contact your vendor for further information.
- Make sure to connect the cables to the correct ports.
- Place connecting cables carefully so that no one will step on them or stumble over them.
- Always disconnect all cables from this device before servicing or disassembling.
- Use ONLY an appropriate power adaptor or cord for your device.
- Connect the power adaptor or cord to the right supply voltage (for example, 110V AC in North America or 230V AC in Europe).
- Do NOT allow anything to rest on the power adaptor or cord and do NOT place the product where anyone can walk on the power adaptor or cord.
- Do NOT use the device if the power adaptor or cord is damaged as it might cause electrocution.
- If the power adaptor or cord is damaged, remove it from the power outlet.
- Do NOT attempt to repair the power adaptor or cord. Contact your local vendor to order a new one.
- Do not use the device outside, and make sure all the connections are indoors. There is a remote risk of electric shock from lightning.

This product is recyclable. Dispose of it properly.



Contents Overview

Introduction and Registration	43
Getting to Know Your ZyWALL	45
Introducing the Web Configurator	49
Wizard Setup	67
Tutorial	85
Registration	117
Network	121
LAN Screens	123
Bridge Screens	135
WAN Screens	141
DMZ Screens	161
Wireless LAN	171
Security	179
Firewall	181
Content Filtering Screens	209
Content Filtering Reports	225
IPSec VPN	233
Certificates	273
Authentication Server	299
Advanced	305
Network Address Translation (NAT)	307
Static Route	321
Bandwidth Management	325
DNS	339
Remote Management	351
UPnP	373
ALG Screen	383
Logs and Maintenance	389
Logs Screens	391
Maintenance	423
SMT and Troubleshooting	439
Introducing the SMT	441

SMT Menu 1 - General Setup	449
WAN and Dial Backup Setup	455
LAN Setup	467
Internet Access	473
DMZ Setup	477
Remote Node Setup	481
IP Static Route Setup	491
Network Address Translation (NAT)	493
Introducing the ZyWALL Firewall	511
Filter Configuration	513
SNMP Configuration	529
System Information & Diagnosis	531
Firmware and Configuration File Maintenance	543
System Maintenance Menus 8 to 10	557
Remote Management	565
Call Scheduling	569
Troubleshooting	573
Appendices and Index	579

Table of Contents

About This User's Guide	3
Document Conventions.....	4
Safety Warnings.....	6
Contents Overview	7
Table of Contents.....	9
List of Figures	25
List of Tables.....	37
Part I: Introduction and Registration	43
Chapter 1	
Getting to Know Your ZyWALL.....	45
1.1 ZyWALL Internet Security Appliance Overview	45
1.2 Applications for the ZyWALL	45
1.2.1 Secure Broadband Internet Access via Cable or DSL Modem	45
1.2.2 VPN Application	46
1.3 Ways to Manage the ZyWALL	46
1.4 Good Habits for Managing the ZyWALL	47
1.5 LEDs	47
Chapter 2	
Introducing the Web Configurator	49
2.1 Web Configurator Overview	49
2.2 Accessing the ZyWALL Web Configurator	49
2.3 Resetting the ZyWALL	51
2.3.1 Procedure To Use The Reset Button	51
2.3.2 Uploading a Configuration File Via Console Port	51
2.4 Navigating the ZyWALL Web Configurator	52
2.4.1 Title Bar	52
2.4.2 Main Window	53
2.4.3 HOME Screen: Router Mode	53
2.4.4 HOME Screen: Bridge Mode	55
2.4.5 Navigation Panel	58

2.4.6 Port Statistics	62
2.4.7 DHCP Table Screen	63
2.4.8 VPN Status	64
2.4.9 Bandwidth Monitor	65
Chapter 3	
Wizard Setup	67
3.1 Wizard Setup Overview	67
3.2 Internet Access	67
3.2.1 ISP Parameters	68
3.2.2 Internet Access Wizard: Second Screen	72
3.2.3 Internet Access Wizard: Registration	73
3.3 VPN Wizard Gateway Setting	76
3.4 VPN Wizard Network Setting	77
3.5 VPN Wizard IKE Tunnel Setting (IKE Phase 1)	79
3.6 VPN Wizard IPSec Setting (IKE Phase 2)	80
3.7 VPN Wizard Status Summary	82
3.8 VPN Wizard Setup Complete	84
Chapter 4	
Tutorial	85
4.1 Security Settings for VPN Traffic	85
4.1.1 Firewall Rule for VPN Example	85
4.1.2 Configuring the VPN Rule	86
4.1.3 Configuring the Firewall Rules	89
4.2 Using NAT with Multiple Public IP Addresses	92
4.2.1 Example Parameters and Scenario	93
4.2.2 Configuring the WAN Connection with a Static IP Address	94
4.2.3 Public IP Address Mapping	97
4.2.4 Forwarding Traffic from the WAN to a Local Computer	101
4.2.5 Allow WAN-to-LAN Traffic through the Firewall	103
4.2.6 Testing the Connections	109
4.3 Using NAT with Multiple Game Players	109
4.4 How to Manage the ZyWALL's Bandwidth	110
4.4.1 Example Parameters and Scenario	111
4.4.2 Configuring Bandwidth Management Rules	111
Chapter 5	
Registration	117
5.1 myZyXEL.com overview	117
5.1.1 Content Filtering Subscription Service	117
5.2 Registration	118
5.3 Service	119

Part II: Network	121
Chapter 6	
LAN Screens	123
6.1 LAN, WAN and the ZyWALL	123
6.2 IP Address and Subnet Mask	123
6.2.1 Private IP Addresses	124
6.3 DHCP	125
6.3.1 IP Pool Setup	125
6.4 RIP Setup	125
6.5 Multicast	125
6.6 WINS	126
6.7 LAN	126
6.8 LAN Static DHCP	129
6.9 LAN IP Alias	130
6.10 LAN Port Roles	132
Chapter 7	
Bridge Screens	135
7.1 Bridge Loop	135
7.2 Spanning Tree Protocol (STP)	136
7.2.1 Rapid STP	136
7.2.2 STP Terminology	136
7.2.3 How STP Works	136
7.2.4 STP Port States	137
7.3 Bridge	137
7.4 Bridge Port Roles	139
Chapter 8	
WAN Screens	141
8.1 WAN Overview	141
8.2 TCP/IP Priority (Metric)	141
8.3 WAN Route	141
8.4 WAN IP Address Assignment	143
8.5 DNS Server Address Assignment	143
8.6 WAN MAC Address	144
8.7 WAN	144
8.7.1 WAN Ethernet Encapsulation	144
8.7.2 PPPoE Encapsulation	147
8.7.3 PPTP Encapsulation	150
8.8 Traffic Redirect	153
8.9 Configuring Traffic Redirect	154
8.10 Configuring Dial Backup	155

8.11 Advanced Modem Setup	158
8.11.1 AT Command Strings	158
8.11.2 DTR Signal	159
8.11.3 Response Strings	159
8.12 Configuring Advanced Modem Setup	159
Chapter 9	
DMZ Screens	161
9.1 DMZ	161
9.2 Configuring DMZ	161
9.3 DMZ Static DHCP	164
9.4 DMZ IP Alias	165
9.5 DMZ Public IP Address Example	167
9.6 DMZ Private and Public IP Address Example	167
9.7 DMZ Port Roles	168
Chapter 10	
Wireless LAN	171
10.1 Wireless LAN Introduction	171
10.2 Configuring WLAN	171
10.3 WLAN Static DHCP	174
10.4 WLAN IP Alias	175
10.5 WLAN Port Roles	177
Part III: Security	179
Chapter 11	
Firewall	181
11.1 Firewall Overview	181
11.2 Packet Direction Matrix	182
11.3 Packet Direction Examples	183
11.3.1 To VPN Packet Direction	184
11.3.2 From VPN Packet Direction	185
11.3.3 From VPN To VPN Packet Direction	187
11.4 Security Considerations	188
11.5 Firewall Rules Example	188
11.6 Asymmetrical Routes	190
11.6.1 Asymmetrical Routes and IP Alias	190
11.7 Firewall Default Rule (Router Mode)	191
11.8 Firewall Default Rule (Bridge Mode)	193
11.9 Firewall Rule Summary	194

11.9.1 Firewall Edit Rule	196
11.10 Anti-Probing	199
11.11 Firewall Thresholds	200
11.11.1 Threshold Values	201
11.12 Threshold Screen	201
11.13 Service	203
11.13.1 Firewall Edit Custom Service	204
11.14 My Service Firewall Rule Example	205
Chapter 12	
Content Filtering Screens	209
12.1 Content Filtering Overview	209
12.1.1 Restrict Web Features	209
12.1.2 Create a Filter List	209
12.1.3 Customize Web Site Access	209
12.2 Content Filter General Screen	209
12.3 Content Filtering with an External Database	212
12.4 Content Filter Categories	212
12.5 Content Filter Customization	219
12.6 Customizing Keyword Blocking URL Checking	221
12.6.1 Domain Name or IP Address URL Checking	221
12.6.2 Full Path URL Checking	221
12.6.3 File Name URL Checking	221
12.7 Content Filtering Cache	221
Chapter 13	
Content Filtering Reports.....	225
13.1 Checking Content Filtering Activation	225
13.2 Viewing Content Filtering Reports	225
13.3 Web Site Submission	230
Chapter 14	
IPSec VPN.....	233
14.1 IPSec VPN Overview	233
14.1.1 IKE SA Overview	234
14.2 VPN Rules (IKE)	235
14.3 IKE SA Setup	237
14.3.1 IKE SA Proposal	237
14.4 Additional IPSec VPN Topics	241
14.4.1 SA Life Time	241
14.4.2 IPSec High Availability	242
14.4.3 Encryption and Authentication Algorithms	243
14.5 VPN Rules (IKE) Gateway Policy Edit	243

14.6 IPsec SA Overview	249
14.6.1 Local Network and Remote Network	249
14.6.2 Virtual Address Mapping	250
14.6.3 Active Protocol	251
14.6.4 Encapsulation	251
14.6.5 IPsec SA Proposal and Perfect Forward Secrecy	252
14.7 VPN Rules (IKE): Network Policy Edit	253
14.8 VPN Rules (IKE): Network Policy Edit: Port Forwarding	256
14.9 VPN Rules (IKE): Network Policy Move	258
14.10 IPsec SA Using Manual Keys	259
14.10.1 IPsec SA Proposal Using Manual Keys	259
14.10.2 Authentication and the Security Parameter Index (SPI)	259
14.11 VPN Rules (Manual)	259
14.12 VPN Rules (Manual): Edit	261
14.13 VPN SA Monitor	263
14.14 VPN Global Setting	264
14.15 Telecommuter VPN/IPsec Examples	266
14.15.1 Telecommuters Sharing One VPN Rule Example	266
14.15.2 Telecommuters Using Unique VPN Rules Example	266
14.16 VPN and Remote Management	268
14.17 Hub-and-spoke VPN	268
14.17.1 Hub-and-spoke VPN Example	269
14.17.2 Hub-and-spoke Example VPN Rule Addresses	270
14.17.3 Hub-and-spoke VPN Requirements and Suggestions	270
Chapter 15	
Certificates	273
15.1 Certificates Overview	273
15.1.1 Advantages of Certificates	274
15.2 Self-signed Certificates	274
15.3 Verifying a Certificate	274
15.3.1 Checking the Fingerprint of a Certificate on Your Computer	274
15.4 Configuration Summary	275
15.5 My Certificates	276
15.6 My Certificate Details	277
15.7 My Certificate Export	280
15.7.1 Certificate File Export Formats	280
15.8 My Certificate Import	281
15.8.1 Certificate File Formats	282
15.9 My Certificate Create	283
15.10 Trusted CAs	286
15.11 Trusted CA Details	287
15.12 Trusted CA Import	290

15.13 Trusted Remote Hosts	291
15.14 Trusted Remote Host Certificate Details	292
15.15 Trusted Remote Hosts Import	295
15.16 Directory Servers	296
15.17 Directory Server Add or Edit	297
Chapter 16	
Authentication Server.....	299
16.1 Authentication Server Overview	299
16.1.1 Local User Database	299
16.1.2 RADIUS	299
16.1.3 Types of RADIUS Messages	299
16.2 Local User Database	300
16.3 RADIUS	302
Part IV: Advanced	305
Chapter 17	
Network Address Translation (NAT).....	307
17.1 NAT Overview	307
17.1.1 NAT Definitions	307
17.1.2 What NAT Does	308
17.1.3 How NAT Works	308
17.1.4 NAT Application	309
17.1.5 Port Restricted Cone NAT	309
17.1.6 NAT Mapping Types	310
17.2 Using NAT	311
17.2.1 SUA (Single User Account) Versus NAT	311
17.3 NAT Overview Screen	311
17.4 NAT Address Mapping	313
17.4.1 NAT Address Mapping Edit	314
17.5 Port Forwarding	315
17.5.1 Default Server IP Address	315
17.5.2 Port Forwarding: Services and Port Numbers	316
17.5.3 Configuring Servers Behind Port Forwarding (Example)	316
17.5.4 Port Translation	316
17.6 Port Forwarding Screen	317
17.7 Port Triggering	319
Chapter 18	
Static Route	321

18.1 IP Static Route	321
18.2 IP Static Route	321
18.2.1 IP Static Route Edit	322
Chapter 19	
Bandwidth Management.....	325
19.1 Bandwidth Management Overview	325
19.2 Bandwidth Classes and Filters	325
19.3 Proportional Bandwidth Allocation	326
19.4 Application-based Bandwidth Management	326
19.5 Subnet-based Bandwidth Management	326
19.6 Application and Subnet-based Bandwidth Management	326
19.7 Scheduler	327
19.7.1 Priority-based Scheduler	327
19.7.2 Fairness-based Scheduler	327
19.7.3 Maximize Bandwidth Usage	327
19.7.4 Reserving Bandwidth for Non-Bandwidth Class Traffic	327
19.7.5 Maximize Bandwidth Usage Example	328
19.8 Bandwidth Borrowing	329
19.8.1 Bandwidth Borrowing Example	329
19.9 Maximize Bandwidth Usage With Bandwidth Borrowing	330
19.10 Over Allotment of Bandwidth	330
19.11 Configuring Summary	331
19.12 Configuring Class Setup	332
19.12.1 Bandwidth Manager Class Configuration	333
19.12.2 Bandwidth Management Statistics	336
19.13 Bandwidth Manager Monitor	337
Chapter 20	
DNS	339
20.1 DNS Overview	339
20.2 DNS Server Address Assignment	339
20.3 DNS Servers	339
20.4 Address Record	340
20.4.1 DNS Wildcard	340
20.5 Name Server Record	340
20.5.1 Private DNS Server	340
20.6 System Screen	341
20.6.1 Adding an Address Record	342
20.6.2 Inserting a Name Server Record	343
20.7 DNS Cache	345
20.8 Configure DNS Cache	345
20.9 Configuring DNS DHCP	346

20.10 Dynamic DNS	347
20.10.1 DYNDNS Wildcard	348
20.11 Configuring Dynamic DNS	348
Chapter 21	
Remote Management.....	351
21.1 Remote Management Overview	351
21.1.1 Remote Management Limitations	352
21.1.2 System Timeout	352
21.2 WWW (HTTP and HTTPS)	352
21.3 WWW Configuration	353
21.4 HTTPS Example	354
21.4.1 Internet Explorer Warning Messages	355
21.4.2 Netscape Navigator Warning Messages	355
21.4.3 Avoiding the Browser Warning Messages	356
21.4.4 Login Screen	357
21.5 SSH	359
21.6 How SSH Works	359
21.7 SSH Implementation on the ZyWALL	360
21.7.1 Requirements for Using SSH	360
21.8 Configuring SSH	360
21.9 Secure Telnet Using SSH Examples	361
21.9.1 Example 1: Microsoft Windows	361
21.9.2 Example 2: Linux	362
21.10 Secure FTP Using SSH Example	363
21.11 Telnet	364
21.12 Configuring TELNET	364
21.13 FTP	365
21.14 SNMP	366
21.14.1 Supported MIBs	367
21.14.2 SNMP Traps	367
21.14.3 REMOTE MANAGEMENT: SNMP	367
21.15 DNS	369
21.16 Introducing Vantage CNM	369
21.17 Configuring CNM	370
Chapter 22	
UPnP	373
22.1 Universal Plug and Play Overview	373
22.1.1 How Do I Know If I'm Using UPnP?	373
22.1.2 NAT Traversal	373
22.1.3 Cautions with UPnP	373
22.1.4 UPnP and ZyXEL	374

22.2 Configuring UPnP	374
22.3 Displaying UPnP Port Mapping	375
22.4 Installing UPnP in Windows Example	376
22.4.1 Installing UPnP in Windows Me	377
22.4.2 Installing UPnP in Windows XP	378
22.5 Using UPnP in Windows XP Example	378
22.5.1 Auto-discover Your UPnP-enabled Network Device	379
22.5.2 Web Configurator Easy Access	380
Chapter 23	
ALG Screen	383
23.1 ALG Introduction	383
23.1.1 ALG and NAT	383
23.1.2 ALG and the Firewall	383
23.2 FTP	384
23.3 H.323	384
23.4 RTP	384
23.4.1 H.323 ALG Details	384
23.5 SIP	385
23.5.1 STUN	385
23.5.2 SIP ALG Details	385
23.5.3 SIP Signaling Session Timeout	386
23.5.4 SIP Audio Session Timeout	386
23.6 ALG Screen	386
Part V: Logs and Maintenance	389
Chapter 24	
Logs Screens	391
24.1 Configuring View Log	391
24.2 Log Description Example	392
24.2.1 About the Certificate Not Trusted Log	393
24.3 Configuring Log Settings	394
24.4 Configuring Reports	397
24.4.1 Viewing Web Site Hits	399
24.4.2 Viewing Host IP Address	399
24.4.3 Viewing Protocol/Port	400
24.4.4 System Reports Specifications	402
24.5 Log Descriptions	402
24.6 Syslog Logs	420

Chapter 25	
Maintenance	423
25.1 Maintenance Overview	423
25.2 General Setup and System Name	423
25.2.1 General Setup	423
25.3 Configuring Password	424
25.4 Time and Date	425
25.5 Pre-defined NTP Time Server Pools	428
25.5.1 Resetting the Time	428
25.5.2 Time Server Synchronization	428
25.6 Introduction To Transparent Bridging	429
25.7 Transparent Firewalls	430
25.8 Configuring Device Mode (Router)	430
25.9 Configuring Device Mode (Bridge)	432
25.10 F/W Upload Screen	433
25.11 Backup and Restore	435
25.11.1 Backup Configuration	436
25.11.2 Restore Configuration	436
25.11.3 Back to Factory Defaults	437
25.12 Restart Screen	437
Part VI: SMT and Troubleshooting	439
Chapter 26	
Introducing the SMT	441
26.1 Introduction to the SMT	441
26.2 Accessing the SMT via the Console Port	441
26.2.1 Initial Screen	441
26.2.2 Entering the Password	442
26.3 Navigating the SMT Interface	442
26.3.1 Main Menu	443
26.3.2 SMT Menus Overview	445
26.4 Changing the System Password	446
26.5 Resetting the ZyWALL	447
Chapter 27	
SMT Menu 1 - General Setup	449
27.1 Introduction to General Setup	449
27.2 Configuring General Setup	449
27.2.1 Configuring Dynamic DNS	450

Chapter 28	
WAN and Dial Backup Setup.....	455
28.1 Introduction to WAN and Dial Backup Setup	455
28.2 WAN Setup	455
28.3 Dial Backup	456
28.4 Configuring Dial Backup in Menu 2	456
28.5 Advanced WAN Setup	457
28.6 Remote Node Profile (Backup ISP)	459
28.7 Editing PPP Options	461
28.8 Editing TCP/IP Options	461
28.9 Editing Login Script	463
28.10 Remote Node Filter	464
Chapter 29	
LAN Setup.....	467
29.1 Introduction to LAN Setup	467
29.2 Accessing the LAN Menus	467
29.3 LAN Port Filter Setup	467
29.4 TCP/IP and DHCP Ethernet Setup Menu	468
29.4.1 IP Alias Setup	471
Chapter 30	
Internet Access	473
30.1 Introduction to Internet Access Setup	473
30.2 Ethernet Encapsulation	473
30.3 Configuring the PPTP Client	475
30.4 Configuring the PPPoE Client	475
30.5 Basic Setup Complete	476
Chapter 31	
DMZ Setup	477
31.1 Configuring DMZ Setup	477
31.2 DMZ Port Filter Setup	477
31.3 TCP/IP Setup	478
31.3.1 IP Address	478
31.3.2 IP Alias Setup	479
Chapter 32	
Remote Node Setup.....	481
32.1 Introduction to Remote Node Setup	481
32.2 Remote Node Setup	481
32.3 Remote Node Profile Setup	481
32.3.1 Ethernet Encapsulation	482

32.3.2 PPPoE Encapsulation	483
32.3.3 PPTP Encapsulation	485
32.4 Edit IP	486
32.5 Remote Node Filter	488
32.6 Traffic Redirect	489
Chapter 33	
IP Static Route Setup.....	491
33.1 IP Static Route Setup	491
Chapter 34	
Network Address Translation (NAT).....	493
34.1 Using NAT	493
34.1.1 SUA (Single User Account) Versus NAT	493
34.1.2 Applying NAT	493
34.2 NAT Setup	495
34.2.1 Address Mapping Sets	495
34.3 Configuring a Server behind NAT	500
34.4 General NAT Examples	502
34.4.1 Internet Access Only	502
34.4.2 Example 2: Internet Access with a Default Server	504
34.4.3 Example 3: Multiple Public IP Addresses With Inside Servers	504
34.4.4 Example 4: NAT Unfriendly Application Programs	507
34.5 Trigger Port Forwarding	509
34.5.1 Two Points To Remember About Trigger Ports	509
Chapter 35	
Introducing the ZyWALL Firewall.....	511
35.1 Using ZyWALL SMT Menus	511
35.1.1 Activating the Firewall	511
Chapter 36	
Filter Configuration.....	513
36.1 Introduction to Filters	513
36.1.1 The Filter Structure of the ZyWALL	514
36.2 Configuring a Filter Set	516
36.2.1 Configuring a Filter Rule	517
36.2.2 Configuring a TCP/IP Filter Rule	518
36.2.3 Configuring a Generic Filter Rule	520
36.3 Example Filter	522
36.4 Filter Types and NAT	524
36.5 Firewall Versus Filters	524
36.5.1 Packet Filtering:	524

36.5.2 Firewall	525
36.6 Applying a Filter	525
36.6.1 Applying LAN Filters	526
36.6.2 Applying DMZ Filters	526
36.6.3 Applying Remote Node Filters	527
Chapter 37	
SNMP Configuration	529
37.1 SNMP Configuration	529
37.2 SNMP Traps	530
Chapter 38	
System Information & Diagnosis.....	531
38.1 Introduction to System Status	531
38.2 System Status	531
38.3 System Information and Console Port Speed	533
38.3.1 System Information	533
38.3.2 Console Port Speed	534
38.4 Log and Trace	534
38.4.1 Viewing Error Log	534
38.4.2 Syslog Logging	535
38.4.3 Call-Triggering Packet	538
38.5 Diagnostic	539
38.5.1 WAN DHCP	540
Chapter 39	
Firmware and Configuration File Maintenance.....	543
39.1 Introduction	543
39.2 Filename Conventions	543
39.3 Backup Configuration	544
39.3.1 Backup Configuration	544
39.3.2 Using the FTP Command from the Command Line	545
39.3.3 Example of FTP Commands from the Command Line	546
39.3.4 GUI-based FTP Clients	546
39.3.5 File Maintenance Over WAN	546
39.3.6 Backup Configuration Using TFTP	547
39.3.7 TFTP Command Example	547
39.3.8 GUI-based TFTP Clients	547
39.3.9 Backup Via Console Port	548
39.4 Restore Configuration	549
39.4.1 Restore Using FTP	549
39.4.2 Restore Using FTP Session Example	550
39.4.3 Restore Via Console Port	550

39.5 Uploading Firmware and Configuration Files	551
39.5.1 Firmware File Upload	551
39.5.2 Configuration File Upload	552
39.5.3 FTP File Upload Command from the DOS Prompt Example	553
39.5.4 FTP Session Example of Firmware File Upload	553
39.5.5 TFTP File Upload	553
39.5.6 TFTP Upload Command Example	554
39.5.7 Uploading Via Console Port	554
39.5.8 Uploading Firmware File Via Console Port	554
39.5.9 Example Xmodem Firmware Upload Using HyperTerminal	555
39.5.10 Uploading Configuration File Via Console Port	555
39.5.11 Example Xmodem Configuration Upload Using HyperTerminal	556
Chapter 40	
System Maintenance Menus 8 to 10.....	557
40.1 Command Interpreter Mode	557
40.1.1 Command Syntax	558
40.1.2 Command Usage	558
40.2 Call Control Support	559
40.2.1 Budget Management	559
40.2.2 Call History	560
40.3 Time and Date Setting	561
Chapter 41	
Remote Management.....	565
41.1 Remote Management	565
41.1.1 Remote Management Limitations	567
Chapter 42	
Call Scheduling.....	569
42.1 Introduction to Call Scheduling	569
Chapter 43	
Troubleshooting.....	573
43.1 Power, Hardware Connections, and LEDs	573
43.2 ZyWALL Access and Login	574
43.3 Internet Access	576
Part VII: Appendices and Index	579
Appendix A Product Specifications.....	581

Appendix B Setting up Your Computer's IP Address.....	585
Appendix C Pop-up Windows, JavaScripts and Java Permissions.....	601
Appendix D IP Addresses and Subnetting	607
Appendix E	615
Appendix E Common Services.....	615
Appendix F Importing Certificates	619
Appendix G Command Interpreter	631
Appendix H Firewall Commands	639
Appendix I NetBIOS Filter Commands.....	645
Appendix J Certificates Commands	647
Appendix K Brute-Force Password Guessing Protection.....	651
Appendix L Boot Commands.....	653
Appendix M Legal Information.....	655
Appendix N Customer Support.....	659
Index.....	663

List of Figures

Figure 1 Secure Internet Access via Cable, DSL or Wireless Modem	46
Figure 2 VPN Application	46
Figure 3 Front Panel	47
Figure 4 Change Password Screen	50
Figure 5 Replace Certificate Screen	50
Figure 6 Example Xmodem Upload	51
Figure 7 HOME Screen	52
Figure 8 Web Configurator HOME Screen in Router Mode	53
Figure 9 Web Configurator HOME Screen in Bridge Mode	56
Figure 10 HOME > Show Statistics	62
Figure 11 HOME > DHCP Table	63
Figure 12 HOME > VPN Status	64
Figure 13 Home > Bandwidth Monitor	65
Figure 14 Wizard Setup Welcome	67
Figure 15 ISP Parameters: Ethernet Encapsulation	68
Figure 16 ISP Parameters: PPPoE Encapsulation	69
Figure 17 ISP Parameters: PPTP Encapsulation	71
Figure 18 Internet Access Wizard: Second Screen	72
Figure 19 Internet Access Setup Complete	73
Figure 20 Internet Access Wizard: Registration	74
Figure 21 Internet Access Wizard: Registration in Progress	75
Figure 22 Internet Access Wizard: Status	75
Figure 23 Internet Access Wizard: Registration Failed	75
Figure 24 Internet Access Wizard: Registered Device	76
Figure 25 Internet Access Wizard: Activated Services	76
Figure 26 VPN Wizard: Gateway Setting	77
Figure 27 VPN Wizard: Network Setting	78
Figure 28 VPN Wizard: IKE Tunnel Setting	79
Figure 29 VPN Wizard: IPSec Setting	81
Figure 30 VPN Wizard: VPN Status	82
Figure 31 VPN Wizard Setup Complete	84
Figure 32 Firewall Rule for VPN	86
Figure 33 SECURITY > VPN > VPN Rules (IKE)	86
Figure 34 SECURITY > VPN > VPN Rules (IKE)> Add Gateway Policy	87
Figure 35 SECURITY > VPN > VPN Rules (IKE): With Gateway Policy Example	88
Figure 36 SECURITY > VPN > VPN Rules (IKE)> Add Network Policy	89
Figure 37 SECURITY > FIREWALL > Rule Summary	90
Figure 38 SECURITY > FIREWALL > Rule Summary > Edit: Allow	91

Figure 39 SECURITY > FIREWALL > Rule Summary: Allow	92
Figure 40 SECURITY > FIREWALL > Default Rule: Block From VPN To LAN	92
Figure 41 Tutorial Example: Using NAT with Static Public IP Addresses	93
Figure 42 Tutorial Example: WAN Connection with a Static Public IP Address	94
Figure 43 Tutorial Example: WAN Screen	95
Figure 44 Tutorial Example: DNS > System	95
Figure 45 Tutorial Example: DNS > System Edit-1	96
Figure 46 Tutorial Example: DNS > System Edit-2	96
Figure 47 Tutorial Example: DNS > System: Done	97
Figure 48 Tutorial Example: Status	97
Figure 49 Tutorial Example: Mapping Multiple Public IP Addresses to Inside Servers	98
Figure 50 Tutorial Example: NAT > NAT Overview	98
Figure 51 Tutorial Example: NAT > Address Mapping	99
Figure 52 Tutorial Example: NAT Address Mapping Edit: One-to-One (1)	99
Figure 53 Tutorial Example: NAT Address Mapping Edit: One-to-One (2)	100
Figure 54 Tutorial Example: NAT Address Mapping Edit: Many-to-One	100
Figure 55 Tutorial Example: NAT Address Mapping Done	101
Figure 56 Tutorial Example: Forwarding Incoming FTP Traffic to a Local Computer	102
Figure 57 Tutorial Example: NAT Address Mapping Edit: Server	102
Figure 58 Tutorial Example: NAT Port Forwarding	103
Figure 59 Tutorial Example: Forwarding Incoming FTP Traffic to a Local Computer	103
Figure 60 Tutorial Example: Firewall Default Rule	104
Figure 61 Tutorial Example: Firewall Rule: WAN to LAN	104
Figure 62 Tutorial Example: Firewall Rule: WAN to LAN Address Edit for Web Server	105
Figure 63 Tutorial Example: Firewall Rule: WAN to LAN Service Edit for Web Server	105
Figure 64 Tutorial Example: Firewall Rule: WAN to LAN Address Edit for Mail Server	106
Figure 65 Tutorial Example: Firewall Rule: WAN to LAN Service Edit for Mail Server	107
Figure 66 Tutorial Example: Firewall Rule: WAN to LAN Address Edit for FTP Server	108
Figure 67 Tutorial Example: Firewall Rule: WAN to LAN Service Edit for FTP Server	108
Figure 68 Tutorial Example: Firewall Rule Summary	109
Figure 69 Tutorial Example: NAT Address Mapping Done: Game Playing	110
Figure 70 Tutorial Example: Bandwidth Management	111
Figure 71 Tutorial Example: Bandwidth Management Summary	112
Figure 72 Tutorial Example: Bandwidth Management Class Setup	112
Figure 73 Tutorial Example: Bandwidth Management Class Setup: VoIP	113
Figure 74 Tutorial Example: Bandwidth Management Class Setup: FTP	113
Figure 75 Tutorial Example: Bandwidth Management Class Setup: WWW	114
Figure 76 Tutorial Example: Bandwidth Management Class Setup Done	114
Figure 77 Tutorial Example: Bandwidth Management Monitor	115
Figure 78 REGISTRATION	118
Figure 79 REGISTRATION: Registered Device	119
Figure 80 REGISTRATION > Service	120
Figure 81 LAN and WAN	123

Figure 82 NETWORK > LAN	127
Figure 83 NETWORK > LAN > Static DHCP	129
Figure 84 Physical Network & Partitioned Logical Networks	130
Figure 85 NETWORK > LAN > IP Alias	131
Figure 86 NETWORK > LAN > Port Roles	132
Figure 87 Port Roles Change Complete	133
Figure 88 Bridge Loop: Bridge Connected to Wired LAN	135
Figure 89 NETWORK > Bridge	138
Figure 90 NETWORK > Bridge > Port Roles	140
Figure 91 Port Roles Change Complete	140
Figure 92 NETWORK > WAN Route	142
Figure 93 NETWORK > WAN > WAN (Ethernet Encapsulation)	145
Figure 94 NETWORK > WAN > WAN (PPPoE Encapsulation)	148
Figure 95 NETWORK > WAN > WAN (PPTP Encapsulation)	151
Figure 96 Traffic Redirect WAN Setup	154
Figure 97 Traffic Redirect LAN Setup	154
Figure 98 NETWORK > WAN > Traffic Redirect	154
Figure 99 NETWORK > WAN > Dial Backup	156
Figure 100 NETWORK > WAN > Dial Backup > Edit	159
Figure 101 NETWORK > DMZ	162
Figure 102 NETWORK > DMZ > Static DHCP	164
Figure 103 NETWORK > DMZ > IP Alias	166
Figure 104 DMZ Public Address Example	167
Figure 105 DMZ Private and Public Address Example	168
Figure 106 NETWORK > DMZ > Port Roles	169
Figure 107 NETWORK > WLAN	172
Figure 108 NETWORK > WLAN > Static DHCP	174
Figure 109 NETWORK > WLAN > IP Alias	176
Figure 110 WLAN Port Role Example	177
Figure 111 NETWORK > WLAN > Port Roles	178
Figure 112 NETWORK > WLAN > Port Roles: Change Complete	178
Figure 113 Default Firewall Action	181
Figure 114 SECURITY > FIREWALL > Default Rule (Router Mode)	182
Figure 115 Default Block Traffic From WAN to DMZ Example	183
Figure 116 From LAN to VPN Example	185
Figure 117 Block DMZ to VPN Traffic by Default Example	185
Figure 118 From VPN to LAN Example	186
Figure 119 Block VPN to LAN Traffic by Default Example	186
Figure 120 From VPN to VPN Example	187
Figure 121 Block VPN to VPN Traffic by Default Example	187
Figure 122 Blocking All LAN to WAN IRC Traffic Example	188
Figure 123 Limited LAN to WAN IRC Traffic Example	189
Figure 124 Using IP Alias to Solve the Triangle Route Problem	191

Figure 125 SECURITY > FIREWALL > Default Rule (Router Mode)	191
Figure 126 SECURITY > FIREWALL > Default Rule (Bridge Mode)	193
Figure 127 SECURITY > FIREWALL > Rule Summary	195
Figure 128 SECURITY > FIREWALL > Rule Summary > Edit	197
Figure 129 SECURITY > FIREWALL > Anti-Probing	199
Figure 130 Three-Way Handshake	200
Figure 131 SECURITY > FIREWALL > Threshold	201
Figure 132 SECURITY > FIREWALL > Service	203
Figure 133 Firewall Edit Custom Service	204
Figure 134 My Service Firewall Rule Example: Service	205
Figure 135 My Service Firewall Rule Example: Edit Custom Service	205
Figure 136 My Service Firewall Rule Example: Rule Summary	206
Figure 137 My Service Firewall Rule Example: Rule Edit	206
Figure 138 My Service Firewall Rule Example: Rule Configuration	207
Figure 139 My Service Firewall Rule Example: Rule Summary	208
Figure 140 SECURITY > CONTENT FILTER > General	210
Figure 141 Content Filtering Lookup Procedure	212
Figure 142 SECURITY > CONTENT FILTER > Categories	213
Figure 143 SECURITY > CONTENT FILTER > Customization	219
Figure 144 SECURITY > CONTENT FILTER > Cache	222
Figure 145 myZyXEL.com: Login	226
Figure 146 myZyXEL.com: Welcome	226
Figure 147 myZyXEL.com: Service Management	227
Figure 148 Blue Coat: Login	227
Figure 149 Content Filtering Reports Main Screen	228
Figure 150 Blue Coat: Report Home	228
Figure 151 Global Report Screen Example	229
Figure 152 Requested URLs Example	230
Figure 153 Web Page Review Process Screen	231
Figure 154 VPN: Example	233
Figure 155 VPN: IKE SA and IPSec SA	234
Figure 156 Gateway and Network Policies	235
Figure 157 IPSec Fields Summary	235
Figure 158 SECURITY > VPN > VPN Rules (IKE)	236
Figure 159 IKE SA: Main Negotiation Mode, Steps 1 - 2: IKE SA Proposal	237
Figure 160 IKE SA: Main Negotiation Mode, Steps 3 - 4: DH Key Exchange	238
Figure 161 IKE SA: Main Negotiation Mode, Steps 5 - 6: Authentication	238
Figure 162 VPN/NAT Example	241
Figure 163 IPSec High Availability	242
Figure 164 SECURITY > VPN > VPN Rules (IKE) > Edit Gateway Policy	244
Figure 165 Local and Remote Network IP Address Overlap	250
Figure 166 Virtual Mapping of Local and Remote Network IP Addresses	251
Figure 167 VPN: Transport and Tunnel Mode Encapsulation	252

Figure 168 SECURITY > VPN > VPN Rules (IKE) > Edit Network Policy	253
Figure 169 SECURITY > VPN > VPN Rules (IKE) > Edit Network Policy > Port Forwarding	257
Figure 170 SECURITY > VPN > VPN Rules (IKE) > Move Network Policy	258
Figure 171 SECURITY > VPN > VPN Rules (Manual)	260
Figure 172 SECURITY > VPN > VPN Rules (Manual) > Edit	261
Figure 173 SECURITY > VPN > SA Monitor	264
Figure 174 SECURITY > VPN > Global Setting	264
Figure 175 Telecommuters Sharing One VPN Rule Example	266
Figure 176 Telecommuters Using Unique VPN Rules Example	267
Figure 177 VPN for Remote Management Example	268
Figure 178 VPN Topologies	269
Figure 179 Hub-and-spoke VPN Example	270
Figure 180 Certificates on Your Computer	274
Figure 181 Certificate Details	275
Figure 182 Certificate Configuration Overview	275
Figure 183 SECURITY > CERTIFICATES > My Certificates	276
Figure 184 SECURITY > CERTIFICATES > My Certificates > Details	278
Figure 185 SECURITY > CERTIFICATES > My Certificates > Export	281
Figure 186 SECURITY > CERTIFICATES > My Certificates > Import	282
Figure 187 SECURITY > CERTIFICATES > My Certificates > Import: PKCS#12	283
Figure 188 SECURITY > CERTIFICATES > My Certificates > Create	284
Figure 189 SECURITY > CERTIFICATES > Trusted CAs	286
Figure 190 SECURITY > CERTIFICATES > Trusted CAs > Details	288
Figure 191 SECURITY > CERTIFICATES > Trusted CAs > Import	290
Figure 192 SECURITY > CERTIFICATES > Trusted Remote Hosts	291
Figure 193 SECURITY > CERTIFICATES > Trusted Remote Hosts > Details	293
Figure 194 SECURITY > CERTIFICATES > Trusted Remote Hosts > Import	295
Figure 195 SECURITY > CERTIFICATES > Directory Servers	296
Figure 196 SECURITY > CERTIFICATES > Directory Server > Add	297
Figure 197 SECURITY > AUTH SERVER > Local User Database	301
Figure 198 SECURITY > AUTH SERVER > RADIUS	302
Figure 199 How NAT Works	308
Figure 200 NAT Application With IP Alias	309
Figure 201 Port Restricted Cone NAT Example	310
Figure 202 ADVANCED > NAT > NAT Overview	312
Figure 203 ADVANCED > NAT > Address Mapping	313
Figure 204 ADVANCED > NAT > Address Mapping > Edit	314
Figure 205 Multiple Servers Behind NAT Example	316
Figure 206 Port Translation Example	317
Figure 207 ADVANCED > NAT > Port Forwarding	318
Figure 208 Trigger Port Forwarding Process: Example	319
Figure 209 ADVANCED > NAT > Port Triggering	320
Figure 210 Example of Static Routing Topology	321

Figure 211 ADVANCED > STATIC ROUTE > IP Static Route	322
Figure 212 ADVANCED > STATIC ROUTE > IP Static Route > Edit	323
Figure 213 Subnet-based Bandwidth Management Example	326
Figure 214 ADVANCED > BW MGMT > Summary	331
Figure 215 ADVANCED > BW MGMT > Class Setup	332
Figure 216 ADVANCED > BW MGMT > Class Setup > Add Sub-Class	334
Figure 217 ADVANCED > BW MGMT > Class Setup > Statistics	336
Figure 218 ADVANCED > BW MGMT > Monitor	337
Figure 219 Private DNS Server Example	341
Figure 220 ADVANCED > DNS > System DNS	341
Figure 221 ADVANCED > DNS > Add (Address Record)	343
Figure 222 ADVANCED > DNS > Insert (Name Server Record)	344
Figure 223 ADVANCED > DNS > Cache	345
Figure 224 ADVANCED > DNS > DHCP	346
Figure 225 ADVANCED > DNS > DDNS	348
Figure 226 Secure and Insecure Remote Management From the WAN	351
Figure 227 HTTPS Implementation	353
Figure 228 ADVANCED > REMOTE MGMT > WWW	353
Figure 229 Security Alert Dialog Box (Internet Explorer)	355
Figure 230 Security Certificate 1 (Netscape)	356
Figure 231 Security Certificate 2 (Netscape)	356
Figure 232 Example: Lock Denoting a Secure Connection	357
Figure 233 Replace Certificate	358
Figure 234 Device-specific Certificate	358
Figure 235 Common ZyWALL Certificate	358
Figure 236 SSH Communication Over the WAN Example	359
Figure 237 How SSH Works	359
Figure 238 ADVANCED > REMOTE MGMT > SSH	361
Figure 239 SSH Example 1: Store Host Key	362
Figure 240 SSH Example 2: Test	362
Figure 241 SSH Example 2: Log in	363
Figure 242 Secure FTP: Firmware Upload Example	363
Figure 243 ADVANCED > REMOTE MGMT > TELNET	364
Figure 244 ADVANCED > REMOTE MGMT > FTP	365
Figure 245 SNMP Management Model	366
Figure 246 ADVANCED > REMOTE MGMT > SNMP	368
Figure 247 ADVANCED > REMOTE MGMT > DNS	369
Figure 248 ADVANCED > REMOTE MGMT > CNM	370
Figure 249 ADVANCED > UPnP	374
Figure 250 ADVANCED > UPnP > Ports	375
Figure 251 H.323 ALG Example	384
Figure 252 SIP ALG Example	385
Figure 253 ADVANCED > ALG	386

Figure 254 LOGS > View Log	391
Figure 255 myZyXEL.com: Download Center	393
Figure 256 myZyXEL.com: Certificate Download	394
Figure 257 LOGS > Log Settings	395
Figure 258 LOGS > Reports	398
Figure 259 LOGS > Reports: Web Site Hits Example	399
Figure 260 LOGS > Reports: Host IP Address Example	400
Figure 261 LOGS > Reports: Protocol/Port Example	401
Figure 262 MAINTENANCE > General Setup	424
Figure 263 MAINTENANCE > Password	425
Figure 264 MAINTENANCE > Time and Date	426
Figure 265 Synchronization in Process	428
Figure 266 Synchronization is Successful	429
Figure 267 Synchronization Fail	429
Figure 268 MAINTENANCE > Device Mode (Router Mode)	431
Figure 269 MAINTENANCE > Device Mode (Bridge Mode)	432
Figure 270 MAINTENANCE > Firmware Upload	433
Figure 271 Firmware Upload In Process	434
Figure 272 Network Temporarily Disconnected	434
Figure 273 Firmware Upload Error	435
Figure 274 MAINTENANCE > Backup and Restore	435
Figure 275 Configuration Upload Successful	436
Figure 276 Network Temporarily Disconnected	436
Figure 277 Configuration Upload Error	437
Figure 278 Reset Warning Message	437
Figure 279 MAINTENANCE > Restart	438
Figure 280 Initial Screen	442
Figure 281 Password Screen	442
Figure 282 Main Menu (Router Mode)	443
Figure 283 Main Menu (Bridge Mode)	444
Figure 284 Menu 23: System Password	446
Figure 285 Menu 1: General Setup (Router Mode)	449
Figure 286 Menu 1: General Setup (Bridge Mode)	450
Figure 287 Menu 1.1: Configure Dynamic DNS	451
Figure 288 Menu 1.1.1: DDNS Host Summary	452
Figure 289 Menu 1.1.1: DDNS Edit Host	453
Figure 290 MAC Address Cloning in WAN Setup	455
Figure 291 Menu 2: Dial Backup Setup	457
Figure 292 Menu 2.1: Advanced WAN Setup	458
Figure 293 Menu 11.2: Remote Node Profile (Backup ISP)	459
Figure 294 Menu 11.2.1: Remote Node PPP Options	461
Figure 295 Menu 11.2.2: Remote Node Network Layer Options	462
Figure 296 Menu 11.2.3: Remote Node Script	464

Figure 297 Menu 11.2.4: Remote Node Filter	465
Figure 298 Menu 3: LAN Setup	467
Figure 299 Menu 3.1: LAN Port Filter Setup	468
Figure 300 Menu 3: TCP/IP and DHCP Setup	468
Figure 301 Menu 3.2: TCP/IP and DHCP Ethernet Setup	469
Figure 302 Menu 3.2.1: IP Alias Setup	471
Figure 303 Menu 4: Internet Access Setup (Ethernet)	473
Figure 304 Internet Access Setup (PPTP)	475
Figure 305 Internet Access Setup (PPPoE)	476
Figure 306 Menu 5: DMZ Setup	477
Figure 307 Menu 5.1: DMZ Port Filter Setup	477
Figure 308 Menu 5: DMZ Setup	478
Figure 309 Menu 5.2: TCP/IP and DHCP Ethernet Setup	478
Figure 310 Menu 5.2.1: IP Alias Setup	479
Figure 311 Menu 11: Remote Node Setup	481
Figure 312 Menu 11.1: Remote Node Profile for Ethernet Encapsulation	482
Figure 313 Menu 11.1: Remote Node Profile for PPPoE Encapsulation	484
Figure 314 Menu 11.1: Remote Node Profile for PPTP Encapsulation	486
Figure 315 Menu 11.1.2: Remote Node Network Layer Options for Ethernet Encapsulation	487
Figure 316 Menu 11.1.4: Remote Node Filter (Ethernet Encapsulation)	488
Figure 317 Menu 11.1.4: Remote Node Filter (PPPoE or PPTP Encapsulation)	489
Figure 318 Menu 11.1.5: Traffic Redirect Setup	489
Figure 319 Menu 12: IP Static Route Setup	491
Figure 320 Menu 12. 1: Edit IP Static Route	492
Figure 321 Menu 4: Applying NAT for Internet Access	494
Figure 322 Menu 11.1.2: Applying NAT to the Remote Node	494
Figure 323 Menu 15: NAT Setup	495
Figure 324 Menu 15.1: Address Mapping Sets	496
Figure 325 Menu 15.1.255: SUA Address Mapping Rules	496
Figure 326 Menu 15.1.1: First Set	498
Figure 327 Menu 15.1.1.1: Editing/Configuring an Individual Rule in a Set	499
Figure 328 Menu 15.2: NAT Server Sets	500
Figure 329 15.2.1: NAT Server Configuration	501
Figure 330 Menu 15.2: NAT Server Setup	502
Figure 331 Server Behind NAT Example	502
Figure 332 NAT Example 1	503
Figure 333 Menu 4: Internet Access & NAT Example	503
Figure 334 NAT Example 2	504
Figure 335 Menu 15.2: Specifying an Inside Server	504
Figure 336 NAT Example 3	505
Figure 337 Example 3: Menu 11.1.2	505
Figure 338 Example 3: Menu 15.1.1.1	506
Figure 339 Example 3: Final Menu 15.1.1	506

Figure 340 Example 3: Menu 15.2.	507
Figure 341 NAT Example 4	507
Figure 342 Example 4: Menu 15.1.1.1: Address Mapping Rule	508
Figure 343 Example 4: Menu 15.1.1: Address Mapping Rules	508
Figure 344 Menu 15.3.1: Trigger Port Setup	510
Figure 345 Menu 21: Filter and Firewall Setup	511
Figure 346 Menu 21.2: Firewall Setup	512
Figure 347 Outgoing Packet Filtering Process	513
Figure 348 Filter Rule Process	515
Figure 349 Menu 21: Filter and Firewall Setup	516
Figure 350 Menu 21.1: Filter Set Configuration	516
Figure 351 Menu 21.1.1.1: TCP/IP Filter Rule	518
Figure 352 Executing an IP Filter	520
Figure 353 Menu 21.1.1.1: Generic Filter Rule	521
Figure 354 Telnet Filter Example	522
Figure 355 Example Filter: Menu 21.1.3.1	523
Figure 356 Example Filter Rules Summary: Menu 21.1.3	523
Figure 357 Protocol and Device Filter Sets	524
Figure 358 Filtering LAN Traffic	526
Figure 359 Filtering DMZ Traffic	526
Figure 360 Filtering Remote Node Traffic	527
Figure 361 Menu 22: SNMP Configuration	529
Figure 362 Menu 24: System Maintenance	531
Figure 363 Menu 24.1: System Maintenance: Status	532
Figure 364 Menu 24.2: System Information and Console Port Speed	533
Figure 365 Menu 24.2.1: System Maintenance: Information	533
Figure 366 Menu 24.2.2: System Maintenance: Change Console Port Speed	534
Figure 367 Menu 24.3: System Maintenance: Log and Trace	535
Figure 368 Examples of Error and Information Messages	535
Figure 369 Menu 24.3.2: System Maintenance: Syslog Logging	535
Figure 370 Call-Triggering Packet Example	539
Figure 371 Menu 24.4: System Maintenance: Diagnostic	540
Figure 372 WAN & LAN DHCP	540
Figure 373 Telnet into Menu 24.5	545
Figure 374 FTP Session Example	546
Figure 375 System Maintenance: Backup Configuration	548
Figure 376 System Maintenance: Starting Xmodem Download Screen	548
Figure 377 Backup Configuration Example	548
Figure 378 Successful Backup Confirmation Screen	549
Figure 379 Telnet into Menu 24.6	549
Figure 380 Restore Using FTP Session Example	550
Figure 381 System Maintenance: Restore Configuration	550
Figure 382 System Maintenance: Starting Xmodem Download Screen	550

Figure 383 Restore Configuration Example	551
Figure 384 Successful Restoration Confirmation Screen	551
Figure 385 Telnet Into Menu 24.7.1: Upload System Firmware	552
Figure 386 Telnet Into Menu 24.7.2: System Maintenance	552
Figure 387 FTP Session Example of Firmware File Upload	553
Figure 388 Menu 24.7.1 As Seen Using the Console Port	555
Figure 389 Example Xmodem Upload	555
Figure 390 Menu 24.7.2 As Seen Using the Console Port	556
Figure 391 Example Xmodem Upload	556
Figure 392 Command Mode in Menu 24	557
Figure 393 Valid Commands	558
Figure 394 Call Control	559
Figure 395 Budget Management	559
Figure 396 Call History	560
Figure 397 Menu 24: System Maintenance	561
Figure 398 Menu 24.10 System Maintenance: Time and Date Setting	562
Figure 399 Menu 24.11 – Remote Management Control	566
Figure 400 Schedule Setup	569
Figure 401 Schedule Set Setup	570
Figure 402 Applying Schedule Set(s) to a Remote Node (PPPoE)	571
Figure 403 Applying Schedule Set(s) to a Remote Node (PPTP)	572
Figure 404 Console/Dial Backup Cable DB-9 End Pin Layout	583
Figure 405 WIndows 95/98/Me: Network: Configuration	586
Figure 406 Windows 95/98/Me: TCP/IP Properties: IP Address	587
Figure 407 Windows 95/98/Me: TCP/IP Properties: DNS Configuration	588
Figure 408 Windows XP: Start Menu	589
Figure 409 Windows XP: Control Panel	589
Figure 410 Windows XP: Control Panel: Network Connections: Properties	590
Figure 411 Windows XP: Local Area Connection Properties	590
Figure 412 Windows XP: Internet Protocol (TCP/IP) Properties	591
Figure 413 Windows XP: Advanced TCP/IP Properties	592
Figure 414 Windows XP: Internet Protocol (TCP/IP) Properties	593
Figure 415 Macintosh OS 8/9: Apple Menu	594
Figure 416 Macintosh OS 8/9: TCP/IP	594
Figure 417 Macintosh OS X: Apple Menu	595
Figure 418 Macintosh OS X: Network	596
Figure 419 Red Hat 9.0: KDE: Network Configuration: Devices	597
Figure 420 Red Hat 9.0: KDE: Ethernet Device: General	597
Figure 421 Red Hat 9.0: KDE: Network Configuration: DNS	598
Figure 422 Red Hat 9.0: KDE: Network Configuration: Activate	598
Figure 423 Red Hat 9.0: Dynamic IP Address Setting in ifconfig-eth0	599
Figure 424 Red Hat 9.0: Static IP Address Setting in ifconfig-eth0	599
Figure 425 Red Hat 9.0: DNS Settings in resolv.conf	599

Figure 426 Red Hat 9.0: Restart Ethernet Card	599
Figure 427 Red Hat 9.0: Checking TCP/IP Properties	600
Figure 428 Pop-up Blocker	601
Figure 429 Internet Options	602
Figure 430 Internet Options	603
Figure 431 Pop-up Blocker Settings	603
Figure 432 Internet Options	604
Figure 433 Security Settings - Java Scripting	605
Figure 434 Security Settings - Java	605
Figure 435 Java (Sun)	606
Figure 436 Network Number and Host ID	608
Figure 437 Subnetting Example: Before Subnetting	610
Figure 438 Subnetting Example: After Subnetting	611
Figure 439 Security Certificate	619
Figure 440 Login Screen	620
Figure 441 Certificate General Information before Import	620
Figure 442 Certificate Import Wizard 1	621
Figure 443 Certificate Import Wizard 2	621
Figure 444 Certificate Import Wizard 3	622
Figure 445 Root Certificate Store	622
Figure 446 Certificate General Information after Import	623
Figure 447 ZyWALL Trusted CA Screen	624
Figure 448 CA Certificate Example	625
Figure 449 Personal Certificate Import Wizard 1	626
Figure 450 Personal Certificate Import Wizard 2	626
Figure 451 Personal Certificate Import Wizard 3	627
Figure 452 Personal Certificate Import Wizard 4	627
Figure 453 Personal Certificate Import Wizard 5	628
Figure 454 Personal Certificate Import Wizard 6	628
Figure 455 Access the ZyWALL Via HTTPS	628
Figure 456 SSL Client Authentication	629
Figure 457 ZyWALL Secure Login Screen	629
Figure 458 Displaying Log Categories Example	632
Figure 459 Displaying Log Parameters Example	632
Figure 460 Routing Command Example	634
Figure 461 Backup Gateway	635
Figure 462 Managing the Bandwidth of an IPSec SA	636
Figure 463 Managing the Bandwidth of an IKE SA	636
Figure 464 Routing Command Example	637
Figure 465 Option to Enter Debug Mode	653
Figure 466 Boot Module Commands	654

List of Tables

Table 1 Front Panel LEDs	47
Table 2 Title Bar: Web Configurator Icons	52
Table 3 Web Configurator HOME Screen in Router Mode	53
Table 4 Web Configurator HOME Screen in Bridge Mode	56
Table 5 Bridge and Router Mode Features Comparison	58
Table 6 Screens Summary	59
Table 7 HOME > Show Statistics	63
Table 8 HOME > DHCP Table	64
Table 9 HOME > VPN Status	65
Table 10 ISP Parameters: Ethernet Encapsulation	68
Table 11 ISP Parameters: PPPoE Encapsulation	70
Table 12 ISP Parameters: PPTP Encapsulation	71
Table 13 Internet Access Wizard: Registration	74
Table 14 VPN Wizard: Gateway Setting	77
Table 15 VPN Wizard: Network Setting	78
Table 16 VPN Wizard: IKE Tunnel Setting	80
Table 17 VPN Wizard: IPSec Setting	81
Table 18 VPN Wizard: VPN Status	83
Table 19 REGISTRATION	118
Table 20 REGISTRATION > Service	120
Table 21 NETWORK > LAN	127
Table 22 NETWORK > LAN > Static DHCP	130
Table 23 NETWORK > LAN > IP Alias	131
Table 24 NETWORK > LAN > Port Roles	132
Table 25 STP Path Costs	136
Table 26 STP Port States	137
Table 27 NETWORK > Bridge	138
Table 28 NETWORK > Bridge > Port Roles	140
Table 29 NETWORK > WAN Route	142
Table 30 Private IP Address Ranges	143
Table 31 Example of Network Properties for LAN Servers with Fixed IP Addresses	144
Table 32 NETWORK > WAN > WAN (Ethernet Encapsulation)	145
Table 33 NETWORK > WAN > WAN (PPPoE Encapsulation)	148
Table 34 NETWORK > WAN > WAN (PPTP Encapsulation)	151
Table 35 NETWORK > WAN > Traffic Redirect	155
Table 36 NETWORK > WAN > Dial Backup	156
Table 37 NETWORK > WAN > Dial Backup > Edit	160
Table 38 NETWORK > DMZ	162

Table 39 NETWORK > DMZ > Static DHCP	165
Table 40 NETWORK > DMZ > IP Alias	166
Table 41 NETWORK > DMZ > Port Roles	169
Table 42 NETWORK > WLAN	172
Table 43 NETWORK > WLAN > Static DHCP	175
Table 44 NETWORK > WLAN > IP Alias	176
Table 45 NETWORK > WLAN > Port Roles	178
Table 46	182
Table 47 Blocking All LAN to WAN IRC Traffic Example	189
Table 48 Limited LAN to WAN IRC Traffic Example	189
Table 49 SECURITY > FIREWALL > Default Rule (Router Mode)	192
Table 50 SECURITY > FIREWALL > Default Rule (Bridge Mode)	194
Table 51 SECURITY > FIREWALL > Rule Summary	195
Table 52 SECURITY > FIREWALL > Rule Summary > Edit	198
Table 53 SECURITY > FIREWALL > Anti-Probing	200
Table 54 SECURITY > FIREWALL > Threshold	202
Table 55 SECURITY > FIREWALL > Service	203
Table 56 SECURITY > FIREWALL > Service > Add	204
Table 57 SECURITY > CONTENT FILTER > General	210
Table 58 SECURITY > CONTENT FILTER > Categories	213
Table 59 SECURITY > CONTENT FILTER > Customization	219
Table 60 SECURITY > CONTENT FILTER > Cache	222
Table 61 SECURITY > VPN > VPN Rules (IKE)	236
Table 62 VPN Example: Matching ID Type and Content	239
Table 63 VPN Example: Mismatching ID Type and Content	239
Table 64 SECURITY > VPN > VPN Rules (IKE) > Edit Gateway Policy	245
Table 65 SECURITY > VPN > VPN Rules (IKE) > Edit Network Policy	254
Table 66 SECURITY > VPN > VPN Rules (IKE) > Edit Network Policy > Port Forwarding	257
Table 67 SECURITY > VPN > VPN Rules (IKE) > Move Network Policy	258
Table 68 SECURITY > VPN > VPN Rules (Manual)	260
Table 69 SECURITY > VPN > VPN Rules (Manual) > Edit	261
Table 70 SECURITY > VPN > SA Monitor	264
Table 71 SECURITY > VPN > Global Setting	265
Table 72 Telecommuters Sharing One VPN Rule Example	266
Table 73 Telecommuters Using Unique VPN Rules Example	267
Table 74 SECURITY > CERTIFICATES > My Certificates	276
Table 75 SECURITY > CERTIFICATES > My Certificates > Details	278
Table 76 SECURITY > CERTIFICATES > My Certificates > Export	281
Table 77 SECURITY > CERTIFICATES > My Certificates > Import	282
Table 78 SECURITY > CERTIFICATES > My Certificates > Import: PKCS#12	283
Table 79 SECURITY > CERTIFICATES > My Certificates > Create	284
Table 80 SECURITY > CERTIFICATES > Trusted CAs	286
Table 81 SECURITY > CERTIFICATES > Trusted CAs > Details	288

Table 82 SECURITY > CERTIFICATES > Trusted CAs Import	290
Table 83 SECURITY > CERTIFICATES > Trusted Remote Hosts	291
Table 84 SECURITY > CERTIFICATES > Trusted Remote Hosts > Details	293
Table 85 SECURITY > CERTIFICATES > Trusted Remote Hosts > Import	295
Table 86 SECURITY > CERTIFICATES > Directory Servers	296
Table 87 SECURITY > CERTIFICATES > Directory Server > Add	297
Table 88 SECURITY > AUTH SERVER > Local User Database	301
Table 89 SECURITY > AUTH SERVER > RADIUS	302
Table 90 NAT Definitions	307
Table 91 NAT Mapping Types	311
Table 92 ADVANCED > NAT > NAT Overview	312
Table 93 ADVANCED > NAT > Address Mapping	313
Table 94 ADVANCED > NAT > Address Mapping > Edit	315
Table 95 ADVANCED > NAT > Port Forwarding	318
Table 96 ADVANCED > NAT > Port Triggering	320
Table 97 ADVANCED > STATIC ROUTE > IP Static Route	322
Table 98 ADVANCED > STATIC ROUTE > IP Static Route > Edit	323
Table 99 Application and Subnet-based Bandwidth Management Example	326
Table 100 Maximize Bandwidth Usage Example	328
Table 101 Priority-based Allotment of Unused and Unbudgeted Bandwidth Example	328
Table 102 Fairness-based Allotment of Unused and Unbudgeted Bandwidth Example	329
Table 103 Bandwidth Borrowing Example	330
Table 104 Over Allotment of Bandwidth Example	330
Table 105 ADVANCED > BW MGMT > Summary	331
Table 106 ADVANCED > BW MGMT > Class Setup	333
Table 107 ADVANCED > BW MGMT > Class Setup > Add Sub-Class	334
Table 108 Services and Port Numbers	336
Table 109 ADVANCED > DNS > Add (Address Record)	343
Table 110 ADVANCED > REMOTE MGMT > WWW	354
Table 111 ADVANCED > REMOTE MGMT > SSH	361
Table 112 ADVANCED > REMOTE MGMT > TELNET	364
Table 113 ADVANCED > REMOTE MGMT > FTP	365
Table 114 SNMP Traps	367
Table 115 ADVANCED > REMOTE MGMT > SNMP	368
Table 116 ADVANCED > REMOTE MGMT > DNS	369
Table 117 ADVANCED > REMOTE MGMT > CNM	370
Table 118 ADVANCED > UPnP	374
Table 119 ADVANCED > UPnP > Ports	375
Table 120 ADVANCED > ALG	387
Table 121 LOGS > View Log	392
Table 122 Log Description Example	392
Table 123 LOGS > Log Settings	396
Table 124 LOGS > Reports	398

Table 125 LOGS > Reports: Web Site Hits Report	399
Table 126 LOGS > Reports: Host IP Address	400
Table 127 LOGS > Reports: Protocol/ Port	401
Table 128 Report Specifications	402
Table 129 System Maintenance Logs	402
Table 130 System Error Logs	404
Table 131 Access Control Logs	404
Table 132 TCP Reset Logs	405
Table 133 Packet Filter Logs	405
Table 134 ICMP Logs	405
Table 135 CDR Logs	406
Table 136 PPP Logs	406
Table 137 UPnP Logs	406
Table 138 Content Filtering Logs	407
Table 139 Attack Logs	407
Table 140 Remote Management Logs	409
Table 141 IPSec Logs	409
Table 142 IKE Logs	410
Table 143 PKI Logs	413
Table 144 ACL Setting Notes	414
Table 145 ICMP Notes	415
Table 146 IDP Logs	416
Table 147 AV Logs	417
Table 148 AS Logs	418
Table 149 Syslog Logs	420
Table 150 RFC-2408 ISAKMP Payload Types	421
Table 151 MAINTENANCE > General Setup	424
Table 152 MAINTENANCE > Password	425
Table 153 MAINTENANCE > Time and Date	426
Table 154 MAC-address-to-port Mapping Table	429
Table 155 MAINTENANCE > Device Mode (Router Mode)	431
Table 156 MAINTENANCE > Device Mode (Bridge Mode)	432
Table 157 MAINTENANCE > Firmware Upload	434
Table 158 Restore Configuration	436
Table 159 Main Menu Commands	442
Table 160 Main Menu Summary	444
Table 161 SMT Menus Overview	445
Table 162 Menu 1: General Setup (Router Mode)	449
Table 163 Menu 1: General Setup (Bridge Mode)	450
Table 164 Menu 1.1: Configure Dynamic DNS	451
Table 165 Menu 1.1.1: DDNS Host Summary	452
Table 166 Menu 1.1.1: DDNS Edit Host	453
Table 167 MAC Address Cloning in WAN Setup	456

Table 168 Menu 2: Dial Backup Setup	457
Table 169 Advanced WAN Port Setup: AT Commands Fields	458
Table 170 Advanced WAN Port Setup: Call Control Parameters	459
Table 171 Menu 11.3: Remote Node Profile (Backup ISP)	460
Table 172 Menu 11.2.1: Remote Node PPP Options	461
Table 173 Menu 11.2.2: Remote Node Network Layer Options	462
Table 174 Menu 11.2.3: Remote Node Script	464
Table 175 Menu 3.2: DHCP Ethernet Setup Fields	469
Table 176 Menu 3.2: LAN TCP/IP Setup Fields	470
Table 177 Menu 3.2.1: IP Alias Setup	471
Table 178 Menu 4: Internet Access Setup (Ethernet)	474
Table 179 New Fields in Menu 4 (PPTP) Screen	475
Table 180 New Fields in Menu 4 (PPPoE) screen	476
Table 181 Menu 11.1: Remote Node Profile for Ethernet Encapsulation	482
Table 182 Fields in Menu 11.1 (PPPoE Encapsulation Specific)	485
Table 183 Menu 11.1: Remote Node Profile for PPTP Encapsulation	486
Table 184 Remote Node Network Layer Options Menu Fields	487
Table 185 Menu 11.1.5: Traffic Redirect Setup	489
Table 186 Menu 12. 1: Edit IP Static Route	492
Table 187 Applying NAT in Menus 4 & 11.1.2	495
Table 188 SUA Address Mapping Rules	497
Table 189 Fields in Menu 15.1.1	498
Table 190 Menu 15.1.1.1: Editing/Configuring an Individual Rule in a Set	499
Table 191 15.2.1: NAT Server Configuration	501
Table 192 Menu 15.3: Trigger Port Setup	510
Table 193 Abbreviations Used in the Filter Rules Summary Menu	517
Table 194 Rule Abbreviations Used	517
Table 195 Menu 21.1.1.1: TCP/IP Filter Rule	518
Table 196 Generic Filter Rule Menu Fields	521
Table 197 SNMP Configuration Menu Fields	529
Table 198 SNMP Traps	530
Table 199 System Maintenance: Status Menu Fields	532
Table 200 Fields in System Maintenance: Information	534
Table 201 System Maintenance Menu Syslog Parameters	536
Table 202 System Maintenance Menu Diagnostic	540
Table 203 Filename Conventions	544
Table 204 General Commands for GUI-based FTP Clients	546
Table 205 General Commands for GUI-based TFTP Clients	547
Table 206 Valid Commands	558
Table 207 Budget Management	560
Table 208 Call History	560
Table 209 Menu 24.10 System Maintenance: Time and Date Setting	562
Table 210 Menu 24.11 – Remote Management Control	566

Table 211 Schedule Set Setup	570
Table 212 Hardware Specifications	581
Table 213 Firmware Specifications	581
Table 214 Feature Specifications	583
Table 215 Performance	583
Table 216 Console Cable Pin Assignments	584
Table 217 Console Cable Pin Assignments	584
Table 218 Ethernet Cable Pin Assignments	584
Table 219	608
Table 220 Subnet Masks	609
Table 221 Maximum Host Numbers	609
Table 222 Alternative Subnet Mask Notation	609
Table 223 Subnet 1	611
Table 224 Subnet 2	612
Table 225 Subnet 3	612
Table 226 Subnet 4	612
Table 227 Eight Subnets	612
Table 228 24-bit Network Number Subnet Planning	613
Table 229 16-bit Network Number Subnet Planning	613
Table 230 Commonly Used Services	615
Table 231 Firewall Commands	639
Table 232 NetBIOS Filter Default Settings	646
Table 233 Certificates Commands	647
Table 234 Brute-Force Password Guessing Protection Commands	651

PART I

Introduction and Registration

Getting to Know Your ZyWALL (45)
Introducing the Web Configurator (49)
Wizard Setup (67)
Tutorial (85)
Registration (117)

Getting to Know Your ZyWALL

This chapter introduces the main features and applications of the ZyWALL.

1.1 ZyWALL Internet Security Appliance Overview

The ZyWALL is loaded with security features including VPN, firewall, content filtering and certificates. The ZyWALL's De-Militarized Zone (DMZ) increases LAN security by providing separate ports for connecting publicly accessible servers. The ZyWALL provides the option to change port roles from LAN to DMZ.

You can also deploy the ZyWALL as a transparent firewall in an existing network with minimal configuration.

The ZyWALL provides bandwidth management, NAT, port forwarding, DHCP server and many other powerful features.

You can add a IEEE 802.11b/g-compliant wireless LAN by connecting an access point (AP) to an Ethernet port in a WLAN port role.

See [Appendix A on page 177](#) for a complete list of features.

1.2 Applications for the ZyWALL

Here are some examples of what you can do with your ZyWALL.

1.2.1 Secure Broadband Internet Access via Cable or DSL Modem

For Internet access, connect the WAN Ethernet port to your existing Internet access gateway (company network, or your cable or DSL modem for example). Connect computers or servers to the LAN ports for shared Internet access.

The ZyWALL guarantees not only high speed Internet access, but secure internal network protection and traffic management as well.

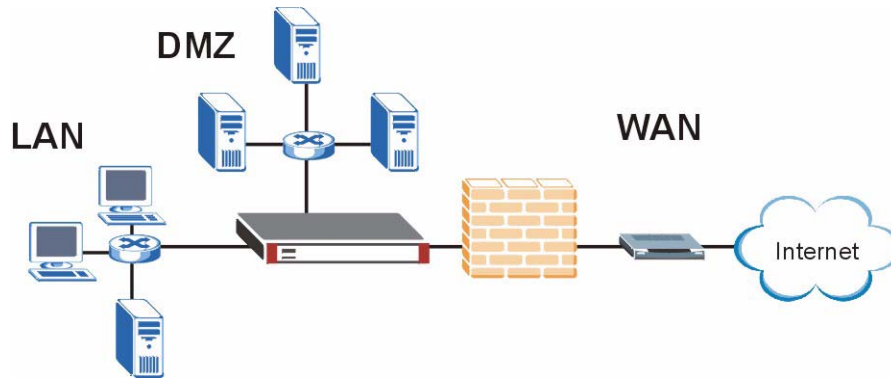
Figure 1 Secure Internet Access via Cable, DSL or Wireless Modem

1.2.2 VPN Application

ZyWALL VPN is an ideal cost-effective way to connect branch offices, business partners and telecommuters over the Internet without the need (and expense) for leased lines between sites.

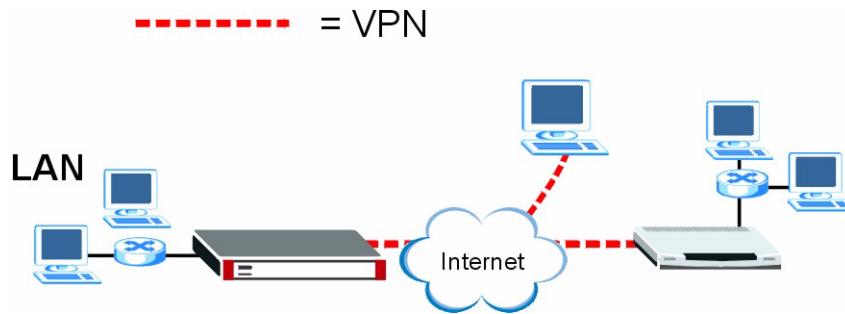
Figure 2 VPN Application

1.3 Ways to Manage the ZyWALL

Use any of the following methods to manage the ZyWALL.

- Web Configurator. This is recommended for everyday management of the ZyWALL using a (supported) web browser.
- Command Line Interface. Line commands are mostly used for troubleshooting by service engineers.
- SMT. System Management Terminal is a text-based configuration menu that you can use to configure your device.
- FTP for firmware upgrades and configuration backup/restore ([Chapter 39 on page 543](#))
- SNMP. The device can be monitored by an SNMP manager. See the SNMP chapter in this User's Guide.
- Vantage CNM (Centralized Network Management). The device can be remotely managed using a Vantage CNM server.

1.4 Good Habits for Managing the ZyWALL

Do the following things regularly to make the ZyWALL more secure and to manage the ZyWALL more effectively.

- Change the password. Use a password that's not easy to guess and that consists of different types of characters, such as numbers and letters.
- Write down the password and put it in a safe place.
- Back up the configuration (and make sure you know how to restore it). Restoring an earlier working configuration may be useful if the device becomes unstable or even crashes. If you forget your password, you will have to reset the ZyWALL to its factory default settings. If you backed up an earlier configuration file, you would not have to totally re-configure the ZyWALL. You could simply restore your last configuration.

1.5 LEDs

Figure 3 Front Panel

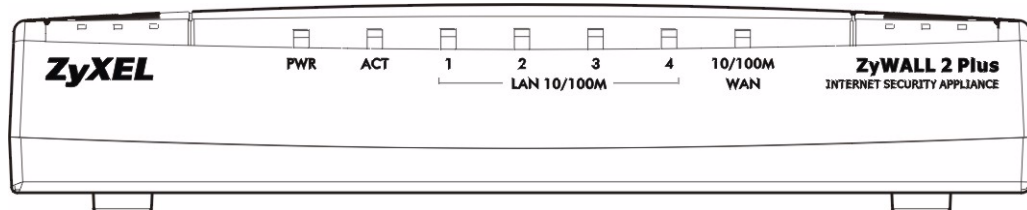

The following table describes the lights.

Table 1 Front Panel LEDs

LED	COLOR	STATUS	DESCRIPTION
PWR		Off	The ZyWALL is turned off.
	Green	On	The ZyWALL is ready and running.
		Flashing	The ZyWALL is restarting.
	Red	On	The power to the ZyWALL is too low.
ACT	Green	Off	The backup port is not connected.
		On	The backup port is connected.
		Flashing	The backup port is sending or receiving packets.
LAN 10/100		Off	The LAN/DMZ/WLAN is not connected.
	Green	On	The ZyWALL has a successful 10Mbps Ethernet connection.
		Flashing	The 10M LAN/DMZ/WLAN is sending or receiving packets.
	Orange	On	The ZyWALL has a successful 100Mbps Ethernet connection.
Flashing		The 100M LAN/DMZ/WLAN is sending or receiving packets.	

Table 1 Front Panel LEDs (continued)

LED	COLOR	STATUS	DESCRIPTION
WAN 10/100		Off	The WAN connection is not ready, or has failed.
	Green	On	The ZyWALL has a successful 10Mbps WAN connection.
		Flashing	The 10M WAN is sending or receiving packets.
	Orange	On	The ZyWALL has a successful 100Mbps WAN connection.
		Flashing	The 100M WAN is sending or receiving packets.

Introducing the Web Configurator

This chapter describes how to access the ZyWALL web configurator and provides an overview of its screens.

2.1 Web Configurator Overview

The web configurator is an HTML-based management interface that allows easy ZyWALL setup and management via Internet browser. Use Internet Explorer 6.0 and later or Netscape Navigator 7.0 and later versions. The recommended screen resolution is 1024 by 768 pixels.

In order to use the web configurator you need to allow:

- Web browser pop-up windows from your device. Web pop-up blocking is enabled by default in Windows XP SP (Service Pack) 2.
- JavaScripts (enabled by default).
- Java permissions (enabled by default).

See the **Troubleshooting** chapter if you want to make sure these functions are allowed in Internet Explorer or Netscape Navigator.

2.2 Accessing the ZyWALL Web Configurator



By default, the packets from WLAN to WLAN/ZyWALL are dropped and users cannot configure the ZyWALL wirelessly.

- 1 Make sure your ZyWALL hardware is properly connected and prepare your computer/ computer network to connect to the ZyWALL (refer to the Quick Start Guide).
- 2 Launch your web browser.
- 3 Type "192.168.1.1" as the URL.
- 4 Type "1234" (default) as the password and click **Login**. In some versions, the default password appears automatically - if this is the case, click **Login**.

- 5 You should see a screen asking you to change your password (highly recommended) as shown next. Type a new password (and retype it to confirm) and click **Apply** or click **Ignore**.

Figure 4 Change Password Screen

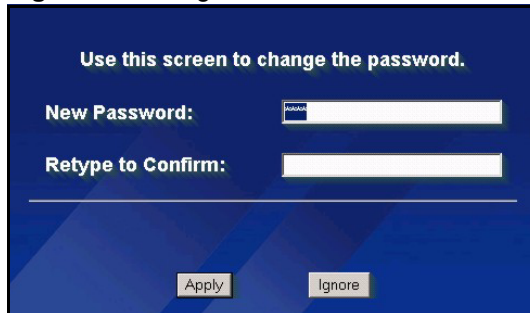

- 6 Click **Apply** in the **Replace Certificate** screen to create a certificate using your ZyWALL's MAC address that will be specific to this device.



If you do not replace the default certificate here or in the CERTIFICATES screen, this screen displays every time you access the web configurator.

Figure 5 Replace Certificate Screen



- 7 You should now see the **HOME** screen (see [Figure 8 on page 53](#)).



The management session automatically times out when the time period set in the Administrator Inactivity Timer field expires (default five minutes). Simply log back into the ZyWALL if this happens to you.

2.3 Resetting the ZyWALL

If you forget your password or cannot access the web configurator, you will need to reload the factory-default configuration file or use the **RESET** button on the back of the ZyWALL. Uploading this configuration file replaces the current configuration file with the factory-default configuration file. This means that you will lose all configurations that you had previously and the speed of the console port will be reset to the default of 9600bps with 8 data bit, no parity, one stop bit and flow control set to none. The password will be reset to 1234, also.

2.3.1 Procedure To Use The Reset Button

Make sure the **PWR** LED is on (not blinking) before you begin this procedure.

- 1 Press the **RESET** button for ten seconds, and then release it. If the **PWR** LED begins to blink, the defaults have been restored and the ZyWALL restarts. Otherwise, go to step 2.
- 2 Turn the ZyWALL off.
- 3 While pressing the **RESET** button, turn the ZyWALL on.
- 4 Continue to hold the **RESET** button. The **PWR** LED will begin to blink and flicker very quickly after about 20 seconds. This indicates that the defaults have been restored and the ZyWALL is now restarting.
- 5 Release the **RESET** button and wait for the ZyWALL to finish restarting.

2.3.2 Uploading a Configuration File Via Console Port

- 1 Download the default configuration file from the ZyXEL FTP site, unzip it and save it in a folder.
- 2 Turn off the ZyWALL, begin a terminal emulation software session and turn on the ZyWALL again. When you see the message "Press Any key to enter Debug Mode within 3 seconds", press any key to enter debug mode.
- 3 Enter "y" at the prompt below to go into debug mode.
- 4 Enter "atlc" after "Enter Debug Mode" message.
- 5 Wait for "Starting XMODEM upload" message before activating Xmodem upload on your terminal. This is an example Xmodem configuration upload using HyperTerminal.

Figure 6 Example Xmodem Upload

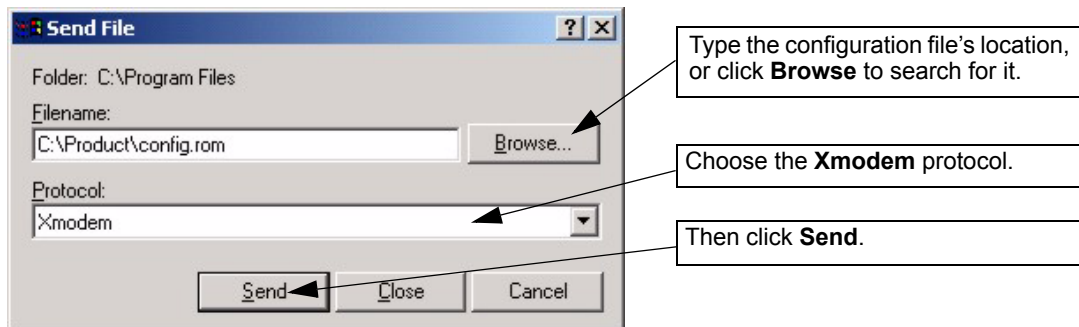

- 6 After successful firmware upload, enter "atgo" to restart the router.

2.4 Navigating the ZyWALL Web Configurator

The following summarizes how to navigate the web configurator from the **HOME** screen. This guide uses the ZyWALL 70 screenshots as an example. The screens may vary slightly for different ZyWALL models.

Figure 7 HOME Screen

The screenshot shows the ZyWALL Web Configurator HOME screen. The interface is divided into four main sections:

- A - Title Bar:** Located at the top, it contains the ZyXEL logo, an 'Automatic Refresh Interval' dropdown set to 'None', a 'Refresh' button, and a 'HELP ?' icon.
- B - Navigation Panel:** A vertical sidebar on the left with a blue background, containing menu items: HOME, REGISTRATION, NETWORK (checked), SECURITY (checked), ADVANCED (checked), LOGS, MAINTENANCE, and LOGOUT.
- C - Main Window:** The central area containing several panels:
 - System Information:** Displays details like Model (ZyWALL 2 Plus), MAC Address, Bootbase Version, Firmware Version, Up Time, System Time, Device Mode (Router), and Firewall (Enabled).
 - System Resources:** Shows progress bars for Flash (3/8MB), Memory (6/50MB), Sessions (27/3000), and CPU (1%).
 - Interfaces:** A table listing WAN, Dial Backup, LAN, WLAN, and DMZ with their respective status, IP/Netmask, IP Assignment, and Renewal status.
 - Security Services:** Shows Content Filter Expiration Date (License Inactive) and Web Site Blocked (N/A).
 - Latest Alerts:** A table of recent alerts with Date/Time and Message.
 - System Status:** Includes buttons for Port Statistics, DHCP Table, VPN, and Bandwidth.
- D - Status Bar:** A horizontal bar at the bottom showing 'Status: Ready'.

As illustrated above, the main screen is divided into these parts:



- **A** - title bar
- **B** - navigation panel
- **C** - main window
- **D** - status bar

2.4.1 Title Bar

The title bar provides some icons in the upper right corner.

The icons provide the following functions.

Table 2 Title Bar: Web Configurator Icons

ICON	DESCRIPTION
	Wizards: Click this icon to open one of the web configurator wizards. See Chapter 3 on page 67 for more information.
	Help: Click this icon to open the help page for the current screen.

2.4.2 Main Window

The main window shows the screen you select in the navigation panel. It is discussed in more detail in the rest of this document.

Right after you log in, the **HOME** screen is displayed. The screen varies according to the device mode you select in the **MAINTENANCE > Device Mode** screen.

2.4.3 HOME Screen: Router Mode

The following screen displays when the ZyWALL is set to router mode. This screen displays general status information about the ZyWALL. The ZyWALL is set to router mode by default.

Figure 8 Web Configurator HOME Screen in Router Mode

The screenshot displays the Web Configurator HOME Screen in Router Mode. At the top, there is an 'Automatic Refresh Interval' dropdown menu set to 'None' and a 'Refresh' button. A 'HELP ?' icon is also present. The main content area is divided into several sections:

- System Information:** Displays details such as System Name, Model (ZyWALL 2 Plus), MAC Address, Bootbase Version, Firmware Version, Up Time, System Time, Device Mode (Router), and Firewall (Enabled).
- Security Services:** Shows Content Filter Expiration Date (License Inactive) and Web Site Blocked (N/A).
- Latest Alerts:** A table listing alerts with Date/Time and Message columns. Recent alerts include 'ip spoofing - WAN UDP' and 'Failed to sync with NTP server: a.ntp.alphazed.net'.
- System Resources:** Displays progress bars and usage for Flash (3/8MB), Memory (6/50MB), Sessions (27/3000), and CPU (1%).
- System Status:** Includes buttons for Port Statistics, DHCP Table, VPN, and Bandwidth.
- Interfaces:** A table showing the status of various interfaces (WAN, Dial Backup, LAN, WLAN, DMZ) including their status, IP/Netmask, IP Assignment, and Renewal status.

The following table describes the labels in this screen.

Table 3 Web Configurator HOME Screen in Router Mode

LABEL	DESCRIPTION
Automatic Refresh Interval	Select a number of seconds or None from the drop-down list box to update all screen statistics automatically at the end of every time interval or to not update the screen statistics.
Refresh	Click this button to update the status screen statistics immediately.
System Information	
System Name	This is the System Name you enter in the MAINTENANCE > General screen. It is for identification purposes. Click the field label to go to the screen where you can specify a name for this ZyWALL.
Model	This is the model name of your ZyWALL.

Table 3 Web Configurator HOME Screen in Router Mode (continued)

LABEL	DESCRIPTION
Bootbase Version	This is the bootbase version and the date created.
Firmware Version	This is the ZyNOS Firmware version and the date created. ZyNOS is ZyXEL's proprietary Network Operating System design. Click the field label to go to the screen where you can upload a new firmware file.
Up Time	This field displays how long the ZyWALL has been running since it last started up. The ZyWALL starts up when you turn it on, when you restart it (MAINTENANCE > Restart), or when you reset it (see Section 2.3 on page 51).
System Time	This field displays your ZyWALL's present date (in yyyy-mm-dd format) and time (in hh:mm:ss format) along with the difference from the Greenwich Mean Time (GMT) zone. The difference from GMT is based on the time zone. It is also adjusted for Daylight Saving Time if you set the ZyWALL to use it. Click the field label to go to the screen where you can modify the ZyWALL's date and time settings.
Device Mode	This displays whether the ZyWALL is functioning as a router or a bridge. Click the field label to go to the screen where you can configure the ZyWALL as a router or a bridge.
Firewall	This displays whether or not the ZyWALL's firewall is activated. Click the field label to go to the screen where you can turn the firewall on or off.
System Resources	
Flash	The first number shows how many megabytes of the flash the ZyWALL is using.
Memory	The first number shows how many megabytes of the heap memory the ZyWALL is using. Heap memory refers to the memory that is not used by ZyNOS (ZyXEL Network Operating System) and is thus available for running processes like NAT, VPN and the firewall. The second number shows the ZyWALL's total heap memory (in megabytes). The bar displays what percent of the ZyWALL's heap memory is in use. The bar turns from green to red when the maximum is being approached.
Sessions	The first number shows how many sessions are currently open on the ZyWALL. This includes all sessions that are currently traversing the ZyWALL, terminating at the ZyWALL or Initiated from the ZyWALL. The second number is the maximum number of sessions that can be open at one time. The bar displays what percent of the maximum number of sessions is in use. The bar turns from green to red when the maximum is being approached.
CPU	This field displays what percentage of the ZyWALL's processing ability is currently used. When this percentage is close to 100%, the ZyWALL is running at full load, and the throughput is not going to improve anymore. If you want some applications to have more throughput, you should turn off other applications (for example, using bandwidth management).
Interfaces	This is the port type. Click "+" to expand or "-" to collapse the IP alias drop-down lists.
Status	For the LAN, DMZ and WLAN ports, this displays the port speed and duplex setting. Ethernet port connections can be in half-duplex or full-duplex mode. Full-duplex refers to a device's ability to send and receive simultaneously, while half-duplex indicates that traffic can flow in only one direction at a time. The Ethernet port must use the same speed or duplex mode setting as the peer Ethernet port in order to connect. For the WAN and Dial Backup ports, it displays the port speed and duplex setting if you're using Ethernet encapsulation and Down (line is down or not connected), Idle (line (ppp) idle), Dial (starting to trigger a call) or Drop (dropping a call) if you're using PPPoE encapsulation.
IP/Netmask	This shows the port's IP address and subnet mask.

Table 3 Web Configurator HOME Screen in Router Mode (continued)

LABEL	DESCRIPTION
IP Assignment	For the WAN, if the ZyWALL gets its IP address automatically from an ISP, this displays DHCP client when you're using Ethernet encapsulation and IPCP Client when you're using PPPoE or PPTP encapsulation. Static displays if the WAN port is using a manually entered static (fixed) IP address. For the LAN, DHCP server displays when the ZyWALL is set to automatically give IP address information to the computers connected to the LAN. DHCP relay displays when the ZyWALL is set to forward IP address assignment requests to another DHCP server. Static displays if the LAN port is using a manually entered static (fixed) IP address. In this case, you must have another DHCP server on your LAN, or else the computers must be manually configured. For the dial backup port, this shows N/A when dial backup is disabled and IPCP client when dial backup is enabled.
Renew	If you are using Ethernet encapsulation and the WAN port is configured to get the IP address automatically from the ISP, click Renew to release the WAN port's dynamically assigned IP address and get the IP address afresh. Click Dial to dial up the PPTP, PPPoE or dial backup connection. Click Drop to disconnect the PPTP, PPPoE or dial backup connection.
Security Services	
Content Filter Expiration Date	This is the date the category-based content filtering service subscription expires. Click the field label to go to the screen where you can update your service subscription.
Web Site Blocked	This displays how many web site hits the ZyWALL has blocked since it last started up. N/A displays when the service subscription has expired.
Latest Alerts	This table displays the five most recent alerts recorded by the ZyWALL. You can see more information in the View Log screen, such as the source and destination IP addresses and port numbers of the incoming packets.
Date/Time	This is the date and time the alert was recorded.
Message	This is the reason for the alert.
System Status	
Port Statistics	Click Port Statistics to see router performance statistics such as the number of packets sent and number of packets received for each port.
DHCP Table	Click DHCP Table to show current DHCP client information.
VPN	Click VPN to display the active VPN connections.
Bandwidth	Click Bandwidth to view the ZyWALL's bandwidth usage and allotments.

2.4.4 HOME Screen: Bridge Mode

The following screen displays when the ZyWALL is set to bridge mode. In bridge mode, the ZyWALL functions as a transparent firewall (also known as a bridge firewall). The ZyWALL bridges traffic traveling between the ZyWALL's interfaces and still filters and inspects packets. You do not need to change the configuration of your existing network.

In bridge mode, the ZyWALL cannot get an IP address from a DHCP server. The LAN, WAN, DMZ and WLAN interfaces all have the same (static) IP address and subnet mask. You can configure the ZyWALL's IP address in order to access the ZyWALL for management. If you connect your computer directly to the ZyWALL, you also need to assign your computer a static IP address in the same subnet as the ZyWALL's IP address in order to access the ZyWALL.

You can use the firewall and VPN in bridge mode.

Figure 9 Web Configurator HOME Screen in Bridge Mode

The screenshot displays the Web Configurator HOME Screen in Bridge Mode. At the top, there is an 'Automatic Refresh Interval' set to 'None' and a 'Refresh' button. The main content is divided into several sections:

- System Information:** Displays details such as System Name (ZyWALL 2 Plus), Model, MAC Address, Bootbase Version, Firmware Version, Up Time, System Time, Device Mode (Bridge), and Firewall (Enabled).
- System Resources:** Shows progress bars for Flash (3/8MB), Memory (6/50MB), Sessions (75/3000), and CPU (0%).
- Network Status:** Lists IP/Netmask Address, Gateway IP Address, and Rapid Spanning Tree Protocol settings.
- Security Services:** Shows Content Filter Expiration Date (License Inactive) and Web Site Blocked (N/A).
- Latest Alerts:** Displays a message from 2000-01-01 00:00:08: 'Failed to sync with NTP server: a.ntp.alphazed.net'.
- System Status:** Includes buttons for Port Statistics, VPN, and Bandwidth.
- Bridge Port Table:** A table with columns: Bridge Port, Port Status, RSTP Status, RSTP Active, RSTP Priority, and RSTP Path Cost. It lists WAN, LAN, WLAN, and DMZ ports with their respective statuses and costs.

The following table describes the labels in this screen.

Table 4 Web Configurator HOME Screen in Bridge Mode

LABEL	DESCRIPTION
Automatic Refresh Interval	Select a number of seconds or None from the drop-down list box to update all screen statistics automatically at the end of every time interval or to not update the screen statistics.
Refresh	Click this button to update the screen's statistics immediately.
System Information	
System Name	This is the System Name you enter in the MAINTENANCE > General screen. It is for identification purposes. Click the field label to go to the screen where you can specify a name for this ZyWALL.
Model	This is the model name of your ZyWALL.
Bootbase Version	This is the bootbase version and the date created.
Firmware Version	This is the ZyNOS Firmware version and the date created. ZyNOS is ZyXEL's proprietary Network Operating System design. Click the field label to go to the screen where you can upload a new firmware file.
Up Time	This field displays how long the ZyWALL has been running since it last started up. The ZyWALL starts up when you turn it on, when you restart it (MAINTENANCE > Restart), or when you reset it (see Section 2.3 on page 51).

Table 4 Web Configurator HOME Screen in Bridge Mode (continued)

LABEL	DESCRIPTION
System Time	This field displays your ZyWALL's present date (in yyyy-mm-dd format) and time (in hh:mm:ss format) along with the difference from the Greenwich Mean Time (GMT) zone. The difference from GMT is based on the time zone. It is also adjusted for Daylight Saving Time if you set the ZyWALL to use it. Click the field label to go to the screen where you can modify the ZyWALL's date and time settings.
Device Mode	This displays whether the ZyWALL is functioning as a router or a bridge. Click the field label to go to the screen where you can configure the ZyWALL as a router or a bridge.
Firewall	This displays whether or not the ZyWALL's firewall is activated. Click the field label to go to the screen where you can turn the firewall on or off.
System Resources	
Flash	The first number shows how many megabytes of the flash the ZyWALL is using.
Memory	The first number shows how many megabytes of the heap memory the ZyWALL is using. Heap memory refers to the memory that is not used by ZyNOS (ZyXEL Network Operating System) and is thus available for running processes like NAT, VPN and the firewall. The second number shows the ZyWALL's total heap memory (in megabytes). The bar displays what percent of the ZyWALL's heap memory is in use. The bar turns from green to red when the maximum is being approached.
Sessions	The first number shows how many sessions are currently open on the ZyWALL. This includes all sessions that are currently traversing the ZyWALL, terminating at the ZyWALL or initiated from the ZyWALL. The second number is the maximum number of sessions that can be open at one time. The bar displays what percent of the maximum number of sessions is in use. The bar turns from green to red when the maximum is being approached.
CPU	This field displays what percentage of the ZyWALL's processing ability is currently used. When this percentage is close to 100%, the ZyWALL is running at full load, and the throughput is not going to improve anymore. If you want some applications to have more throughput, you should turn off other applications (for example, using bandwidth management).
Network Status	
IP/Netmask Address	This is the IP address and subnet mask of your ZyWALL in dotted decimal notation.
Gateway IP Address	This is the gateway IP address.
Rapid Spanning Tree Protocol	This shows whether RSTP (Rapid Spanning Tree Protocol) is active or not. The following labels or values relative to RSTP do not apply when RSTP is disabled.
Bridge Priority	This is the bridge priority of the ZyWALL. The bridge (or switch) with the lowest bridge priority value in the network is the root bridge (the base of the spanning tree).
Bridge Hello Time	This is the interval of BPDUs (Bridge Protocol Data Units) from the root bridge.
Bridge Max Age	This is the predefined interval that a bridge waits to get a Hello message (BPDU) from the root bridge.
Forward Delay	This is the forward delay interval.
Bridge Port	This is the port type. Port types are: WAN, LAN, DMZ and WLAN.

Table 4 Web Configurator HOME Screen in Bridge Mode (continued)

LABEL	DESCRIPTION
Port Status	For the WAN, LAN, DMZ, and WLAN Interfaces, this displays the port speed and duplex setting. For the WAN port, it displays Down when the link is not ready or has failed.
RSTP Status	This is the RSTP status of the corresponding port.
RSTP Active	This shows whether or not RSTP is active on the corresponding port.
RSTP Priority	This is the RSTP priority of the corresponding port.
RSTP Path Cost	This is the cost of transmitting a frame from the root bridge to the corresponding port.
Security Services	
Content Filter Expiration Date	This is the date the category-based content filtering service subscription expires. Click the field label to go to the screen where you can update your service subscription.
Web Site Blocked	This displays how many web site hits the ZyWALL has blocked since it last started up. N/A displays when the service subscription has expired.
Latest Alerts	This table displays the five most recent alerts recorded by the ZyWALL. You can see more information in the View Log screen, such as the source and destination IP addresses and port numbers of the incoming packets.
Date/Time	This is the date and time the alert was recorded.
Message	This is the reason for the alert.
System Status	
Port Statistics	Click Port Statistics to see router performance statistics such as the number of packets sent and number of packets received for each port.
VPN	Click VPN to display the active VPN connections.
Bandwidth	Click Bandwidth to view the ZyWALL's bandwidth usage and allotments.

2.4.5 Navigation Panel

After you enter the password, use the sub-menus on the navigation panel to configure ZyWALL features.

The following table lists the features available for each device mode. Not all ZyWALLs have all features listed in this table.

Table 5 Bridge and Router Mode Features Comparison

FEATURE	BRIDGE MODE	ROUTER MODE
Internet Access Wizard		O
VPN Wizard	O	O
DHCP Table		O
System Statistics	O	O
Registration	O	O
LAN		O
WAN		O
DMZ		O
Bridge	O	

Table 5 Bridge and Router Mode Features Comparison

FEATURE	BRIDGE MODE	ROUTER MODE
WLAN		O
Firewall	O	O
Content Filter	O	O
VPN	O	O
Certificates	O	O
Authentication Server	O	O
NAT		O
Static Route		O
Bandwidth Management	O	O
DNS		O
Remote Management	O	O
UPnP		O
ALG	O	O
Logs	O	O
Maintenance	O	O

Table Key: An O in a mode's column shows that the device mode has the specified feature. The information in this table was correct at the time of writing, although it may be subject to change.

The following table describes the sub-menus.

Table 6 Screens Summary

LINK	TAB	FUNCTION
HOME		This screen shows the ZyWALL's general device and network status information. Use this screen to access the wizards, statistics and DHCP table.
REGISTRATION	Registration	Use this screen to register your ZyWALL and activate the trial service subscriptions.
	Service	Use this to manage and update the service status and license information.
NETWORK		
LAN	LAN	Use this screen to configure LAN DHCP and TCP/IP settings.
	Static DHCP	Use this screen to assign fixed IP addresses on the LAN.
	IP Alias	Use this screen to partition your LAN interface into subnets.
	Port Roles	Use this screen to change the LAN/DMZ/WLAN port roles.
BRIDGE	Bridge	Use this screen to change the bridge settings on the ZyWALL.
	Port Roles	Use this screen to change the LAN/DMZ/WLAN port roles on the ZyWALL.

Table 6 Screens Summary (continued)

LINK	TAB	FUNCTION
WAN	General	This screen allows you to configure load balancing, route priority and traffic redirect properties.
	Route	This screen allows you to configure route priority.
	WAN	Use this screen to configure the WAN port for internet access.
	Traffic Redirect	Use this screen to configure your traffic redirect properties and parameters.
	Dial Backup	Use this screen to configure the backup WAN dial-up connection.
DMZ	DMZ	Use this screen to configure your DMZ connection.
	Static DHCP	Use this screen to assign fixed IP addresses on the DMZ.
	IP Alias	Use this screen to partition your DMZ interface into subnets.
	Port Roles	Use this screen to change the LAN/DMZ/WLAN port roles on the ZyWALL.
WLAN	WLAN	Use this screen to configure your WLAN connection.
	Static DHCP	Use this screen to assign fixed IP addresses on the WLAN.
	IP Alias	Use this screen to partition your WLAN interface into subnets.
	Port Roles	Use this screen to change the LAN/DMZ/WLAN port roles on the ZyWALL.
SECURITY		
FIREWALL	Default Rule	Use this screen to activate/deactivate the firewall and the direction of network traffic to which to apply the rule
	Rule Summary	This screen shows a summary of the firewall rules, and allows you to edit/add a firewall rule.
	Anti-Probing	Use this screen to change your anti-probing settings.
	Threshold	Use this screen to configure the threshold for DoS attacks.
	Service	Use this screen to configure custom services.
CONTENT FILTER	General	This screen allows you to enable content filtering and block certain web features.
	Categories	Use this screen to select which categories of web pages to filter out, as well as to register for external database content filtering and view reports.
	Customization	Use this screen to customize the content filter list.
	Cache	Use this screen to view and configure the ZyWALL's URL caching.
VPN	VPN Rules (IKE)	Use this screen to configure VPN connections using IKE key management and view the rule summary.
	VPN Rules (Manual)	Use this screen to configure VPN connections using manual key management and view the rule summary.
	SA Monitor	Use this screen to display and manage active VPN connections.
	Global Setting	Use this screen to configure the IPSec timer settings.

Table 6 Screens Summary (continued)

LINK	TAB	FUNCTION
CERTIFICATES	My Certificates	Use this screen to view a summary list of certificates and manage certificates and certification requests.
	Trusted CAs	Use this screen to view and manage the list of the trusted CAs.
	Trusted Remote Hosts	Use this screen to view and manage the certificates belonging to the trusted remote hosts.
	Directory Servers	Use this screen to view and manage the list of the directory servers.
AUTH SERVER	Local User Database	Use this screen to configure the local user account(s) on the ZyWALL.
	RADIUS	Configure this screen to use an external server to authenticate wireless and/or VPN users.
ADVANCED		
NAT	NAT Overview	Use this screen to enable NAT.
	Address Mapping	Use this screen to configure network address translation mapping rules.
	Port Forwarding	Use this screen to configure servers behind the ZyWALL.
	Port Triggering	Use this screen to change your ZyWALL's port triggering settings.
STATIC ROUTE	IP Static Route	Use this screen to configure IP static routes.
BW MGMT	Summary	Use this screen to enable bandwidth management on an interface.
	Class Setup	Use this screen to set up the bandwidth classes.
	Monitor	Use this screen to view the ZyWALL's bandwidth usage and allotments.
DNS	System	Use this screen to configure the address and name server records.
	Cache	Use this screen to configure the DNS resolution cache.
	DHCP	Use this screen to configure LAN/DMZ/WLAN DNS information.
	DDNS	Use this screen to set up dynamic DNS.
REMOTE MGMT	WWW	Use this screen to configure through which interface(s) and from which IP address(es) users can use HTTPS or HTTP to manage the ZyWALL.
	SSH	Use this screen to configure through which interface(s) and from which IP address(es) users can use Secure Shell to manage the ZyWALL.
	TELNET	Use this screen to configure through which interface(s) and from which IP address(es) users can use Telnet to manage the ZyWALL.
	FTP	Use this screen to configure through which interface(s) and from which IP address(es) users can use FTP to access the ZyWALL.
	SNMP	Use this screen to configure your ZyWALL's settings for Simple Network Management Protocol management.
	DNS	Use this screen to configure through which interface(s) and from which IP address(es) users can send DNS queries to the ZyWALL.
	CNM	Use this screen to configure and allow your ZyWALL to be managed by the Vantage CNM server.

Table 6 Screens Summary (continued)

LINK	TAB	FUNCTION
UPnP	UPnP	Use this screen to enable UPnP on the ZyWALL.
	Ports	Use this screen to view the NAT port mapping rules that UPnP creates on the ZyWALL.
ALG	ALG	Use this screen to allow certain applications to pass through the ZyWALL.
LOGS	View Log	Use this screen to view the logs for the categories that you selected.
	Log Settings	Use this screen to change your ZyWALL's log settings.
	Reports	Use this screen to have the ZyWALL record and display network usage reports.
MAINTENANCE	General	This screen contains administrative.
	Password	Use this screen to change your password.
	Time and Date	Use this screen to change your ZyWALL's time and date.
	Device Mode	Use this screen to configure and have your ZyWALL work as a router or a bridge.
	F/W Upload	Use this screen to upload firmware to your ZyWALL.
	Backup & Restore	Use this screen to backup and restore the configuration or reset the factory defaults to your ZyWALL.
	Restart	This screen allows you to reboot the ZyWALL without turning the power off.
LOGOUT		Click this label to exit the web configurator.

2.4.6 Port Statistics

Click **Port Statistics** in the **HOME** screen. Read-only information here includes port status and packet specific statistics. The **Poll Interval(s)** field is configurable.

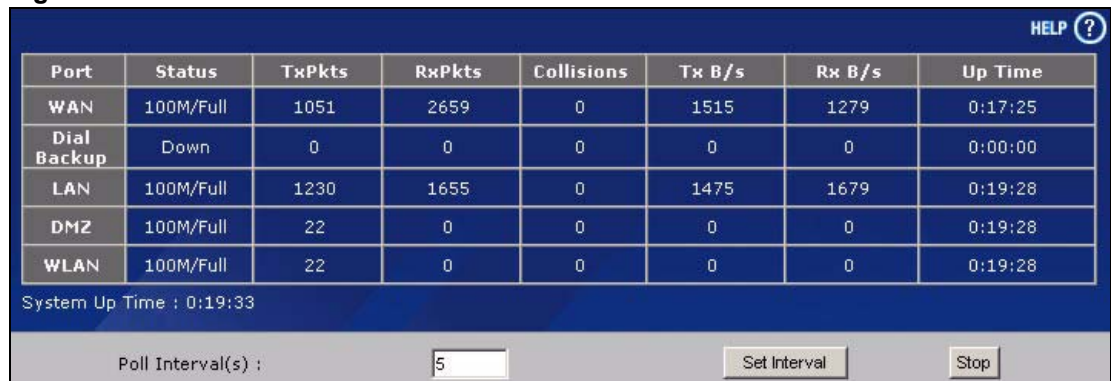
Figure 10 HOME > Show Statistics

Port	Status	TxPkts	RxPkts	Collisions	Tx B/s	Rx B/s	Up Time
WAN	100M/Full	1051	2659	0	1515	1279	0:17:25
Dial Backup	Down	0	0	0	0	0	0:00:00
LAN	100M/Full	1230	1655	0	1475	1679	0:19:28
DMZ	100M/Full	22	0	0	0	0	0:19:28
WLAN	100M/Full	22	0	0	0	0	0:19:28

System Up Time : 0:19:33

Poll Interval(s) :

The following table describes the labels in this screen.

Table 7 HOME > Show Statistics

LABEL	DESCRIPTION
Port	These are the ZyWALL's interfaces.
Status	For the WAN and dial backup ports, this displays the port speed and duplex setting if you're using Ethernet encapsulation and Down (line is down), Idle (line (ppp) idle), Dial (starting to trigger a call) or Drop (dropping a call) if you're using PPPoE encapsulation. Dial backup is not available in bridge mode. For the LAN, DMZ and WLAN ports, this displays the port speed and duplex setting.
TxPkts	This is the number of transmitted packets on this port.
RxPkts	This is the number of received packets on this port.
Collisions	This is the number of collisions on this port.
Tx B/s	This displays the transmission speed in bytes per second on this port.
Rx B/s	This displays the reception speed in bytes per second on this port.
Up Time	This is the total amount of time the line has been up.
System Up Time	This is the total time the ZyWALL has been on.
Poll Interval(s)	Enter a number of seconds to update all screen statistics automatically at the end of every time interval.
Set Interval	Click this button to apply the new poll interval you entered in the Poll Interval(s) field.
Stop	Click Stop to stop refreshing statistics.

2.4.7 DHCP Table Screen

DHCP (Dynamic Host Configuration Protocol, RFC 2131 and RFC 2132) allows individual clients to obtain TCP/IP configuration at start-up from a server. You can configure the ZyWALL as a DHCP server or disable it. When configured as a server, the ZyWALL provides the TCP/IP configuration for the clients. If DHCP service is disabled, you must have another DHCP server on your LAN, or else the computer must be manually configured.

Click **Show DHCP Table** in the **HOME** screen when the ZyWALL is set to router mode. Read-only information here relates to your DHCP status. The DHCP table shows current DHCP client information (including **IP Address**, **Host Name** and **MAC Address**) of all network clients using the ZyWALL's DHCP server.

Figure 11 HOME > DHCP Table

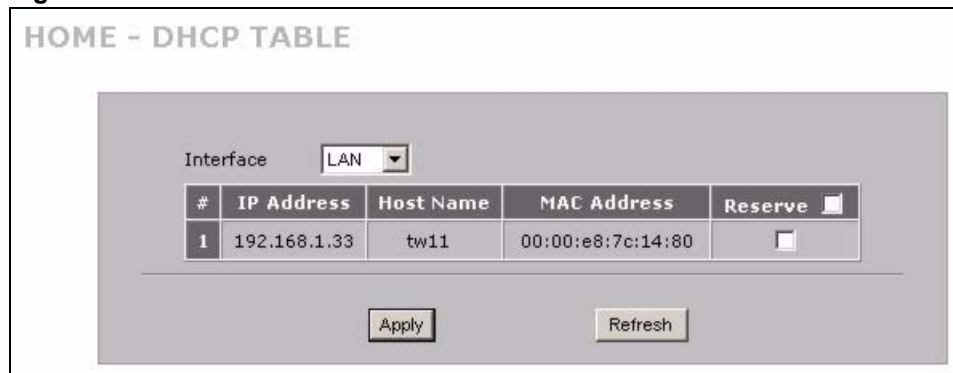

The following table describes the labels in this screen.

Table 8 HOME > DHCP Table

LABEL	DESCRIPTION
Interface	Select LAN , DMZ or WLAN to show the current DHCP client information for the specified interface.
#	This is the index number of the host computer.
IP Address	This field displays the IP address relative to the # field listed above.
Host Name	This field displays the computer host name.
MAC Address	The MAC (Media Access Control) or Ethernet address on a LAN (Local Area Network) is unique to your computer (six pairs of hexadecimal notation). A network interface card such as an Ethernet adapter has a hardwired address that is assigned at the factory. This address follows an industry standard that ensures no other adapter has a similar address.
Reserve	Select the check box in the heading row to automatically select all check boxes or select the check box(es) in each entry to have the ZyWALL always assign the selected entry(ies)'s IP address(es) to the corresponding MAC address(es) (and host name(s)). You can select up to 32 entries in this table. After you click Apply , the MAC address and IP address also display in the Static DHCP screen (where you can edit them) for the specified interface.
Refresh	Click Refresh to reload the DHCP table.

2.4.8 VPN Status

Click **VPN** in the **HOME** screen when the ZyWALL is set to router mode. This screen displays read-only information about the active VPN connections. The **Poll Interval(s)** field is configurable. A Security Association (SA) is the group of security settings related to a specific VPN tunnel.

Figure 12 HOME > VPN Status

The screenshot shows the 'Current IPsec Security Associations' table with the following data:

#	Name	Local Network	Remote Network	Encapsulation	IPsec Algorithm
1	172.20.0.1-172.20.0.37	172.20.0.1 - 172.20.0.37	192.168.70.0 / 255.255.255.0	Tunnel	ESP DES--MD5
2	172.20.0.39-172.23.255.255	172.20.0.39 - 172.23.255.255	192.168.70.0 / 255.255.255.0	Tunnel	ESP DES--MD5

Below the table, the 'Poll Interval(s)' is set to 5. There are 'Set Interval' and 'Stop' buttons.

The following table describes the labels in this screen.

Table 9 HOME > VPN Status

LABEL	DESCRIPTION
#	This is the security association index number.
Name	This field displays the identification name for this VPN policy.
Local Network	This field displays the IP address of the computer using the VPN IPsec feature of your ZyWALL.
Remote Network	This field displays IP address (in a range) of computers on the remote network behind the remote IPsec router.
Encapsulation	This field displays Tunnel or Transport mode.
IPsec Algorithm	This field displays the security protocols used for an SA. Both AH and ESP increase ZyWALL processing requirements and communications latency (delay).
Poll Interval(s)	Enter a number of seconds to update all screen statistics automatically at the end of every time interval.
Set Interval	Click this button to apply the new poll interval you entered in the Poll Interval(s) field.
Stop	Click Stop to stop refreshing statistics.

2.4.9 Bandwidth Monitor

Click **Bandwidth** in the **HOME** screen to display the bandwidth monitor. This screen displays the device's bandwidth usage and allotments.

Figure 13 Home > Bandwidth Monitor

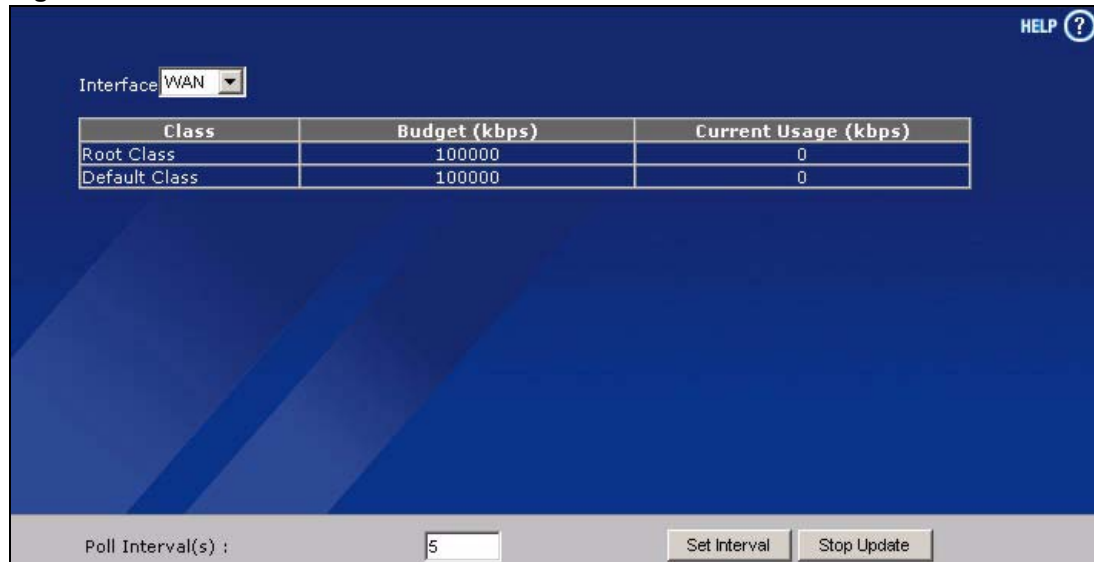

The following table describes the labels in this screen.

LABEL	DESCRIPTION
Interface	Select an interface from the drop-down list box to view the bandwidth usage of its bandwidth classes.
Class	This field displays the name of the bandwidth class. A Default Class automatically displays for all the bandwidth in the Root Class that is not allocated to bandwidth classes. If you do not enable maximize bandwidth usage on an interface, the ZyWALL uses the bandwidth in this default class to send traffic that does not match any of the bandwidth classes. ^A
Budget (kbps)	This field displays the amount of bandwidth allocated to the bandwidth class.
Current Usage (kbps)	This field displays the amount of bandwidth that each bandwidth class is using.
Poll Interval(s)	Enter a number of seconds to update all screen statistics automatically at the end of every time interval.
Set Interval	Click this button to apply the new poll interval you entered in the Poll Interval(s) field.
Stop Update	Click Stop Update to stop refreshing statistics.

A. If you allocate all the root class's bandwidth to the bandwidth classes, the default class still displays a budget of 2 kbps (the minimum amount of bandwidth that can be assigned to a bandwidth class).

Wizard Setup

This chapter provides information on the **Wizard Setup** screens in the web configurator. The Internet access wizard is only applicable when the ZyWALL is in router mode.

3.1 Wizard Setup Overview

The web configurator's setup wizards help you configure Internet and VPN connection settings.

In the **HOME** screen, click the **Wizard** icon  to open the **Wizard Setup Welcome** screen. The following summarizes the wizards you can select:

- **Internet Access Setup**

Click this link to open a wizard to set up an Internet connection for the WAN port.

- **VPN Setup**

Use **VPN Setup** to configure a VPN connection that uses a pre-shared key. If you want to set the rule to use a certificate, please go to the VPN screens for configuration. See [Section 3.3 on page 76](#).

Figure 14 Wizard Setup Welcome



3.2 Internet Access

The Internet access wizard screen has three variations depending on what encapsulation type you use. Refer to information provided by your ISP to know what to enter in each field. Leave a field blank if you don't have that information.

3.2.1 ISP Parameters

The ZyWALL offers three choices of encapsulation. They are **Ethernet**, **PPTP** or **PPPoE**.

The wizard screen varies according to the type of encapsulation that you select in the **Encapsulation** field.

3.2.1.1 Ethernet

For ISPs (such as Telstra) that send UDP heartbeat packets to verify that the customer is still online, please create a **WAN-to-WAN/ZyWALL** firewall rule for those packets. Contact your ISP to find the correct port number.

Choose **Ethernet** when the WAN port is used as a regular Ethernet.

Figure 15 ISP Parameters: Ethernet Encapsulation

The screenshot shows the 'WIZARD - Internet Access' configuration screen. It is divided into two main sections:

- ISP Parameters for Internet Access:** This section contains a text box explaining that users can select between Ethernet, PPPoE, and PPTP. Below this is a dropdown menu for 'Encapsulation' which is currently set to 'Ethernet'.
- WAN IP Address Assignment:** This section contains a dropdown menu for 'IP Address Assignment' set to 'Static'. Below this are five input fields for IP addresses, each with a dotted separator: 'My WAN IP Address', 'My WAN IP Subnet Mask', 'Gateway IP Address', 'First DNS Server', and 'Second DNS Server'. All these fields currently contain '0 . 0 . 0 . 0'.

At the bottom right of the form are 'Back' and 'Apply' buttons.

The following table describes the labels in this screen.

Table 10 ISP Parameters: Ethernet Encapsulation

LABEL	DESCRIPTION
ISP Parameters for Internet Access	
Encapsulation	You must choose the Ethernet option when the WAN port is used as a regular Ethernet. Otherwise, choose PPPoE or PPTP for a dial-up connection.
WAN IP Address Assignment	
IP Address Assignment	Select Dynamic If your ISP did not assign you a fixed IP address. This is the default selection. Select Static If the ISP assigned a fixed IP address. The fields below are available only when you select Static .

Table 10 ISP Parameters: Ethernet Encapsulation

LABEL	DESCRIPTION
My WAN IP Address	Enter your WAN IP address in this field.
My WAN IP Subnet Mask	Enter the IP subnet mask in this field.
Gateway IP Address	Enter the gateway IP address in this field.
First DNS Server Second DNS Server	Enter the DNS server's IP address(es) in the field(s) to the right. Leave the field as 0.0.0.0 if you do not want to configure DNS servers. If you do not configure a DNS server, you must know the IP address of a machine in order to access it.
Back	Click Back to return to the previous wizard screen.
Apply	Click Apply to save your changes and go to the next screen.

3.2.1.2 PPPoE Encapsulation

Point-to-Point Protocol over Ethernet (PPPoE) functions as a dial-up connection. PPPoE is an IETF (Internet Engineering Task Force) standard specifying how a host personal computer interacts with a broadband modem (for example DSL, cable, wireless, etc.) to achieve access to high-speed data networks.

Figure 16 ISP Parameters: PPPoE Encapsulation

The screenshot shows the 'WIZARD - Internet Access' configuration interface. It is divided into two main sections: 'ISP Parameters for Internet Access' and 'WAN IP Address Assignment'.

ISP Parameters for Internet Access:

- Encapsulation:** A dropdown menu set to 'PPP over Ethernet'.
- Service Name:** An empty text field with '(Optional)' to its right.
- User Name:** An empty text field.
- Password:** A text field with seven asterisks (*****).
- Retype to Confirm:** A text field with seven asterisks (*****).
- Nailed-Up:** An unchecked checkbox.
- Idle Timeout:** A text field containing '100' with '(Seconds)' to its right.

WAN IP Address Assignment:

- IP Address Assignment:** A dropdown menu set to 'Static'.
- My WAN IP Address:** A text field containing '0 . 0 . 0 . 0'.
- First DNS Server:** A text field containing '0 . 0 . 0 . 0'.
- Second DNS Server:** A text field containing '0 . 0 . 0 . 0'.

At the bottom right of the form, there are two buttons: 'Back' and 'Apply'.

The following table describes the labels in this screen.

Table 11 ISP Parameters: PPPoE Encapsulation

LABEL	DESCRIPTION
ISP Parameter for Internet Access	
Encapsulation	Choose an encapsulation method from the pull-down list box. PPP over Ethernet forms a dial-up connection.
Service Name	Type the name of your service provider. This field is optional.
User Name	Type the user name given to you by your ISP.
Password	Type the password associated with the user name above.
Retype to Confirm	Type your password again for confirmation.
Nailed-Up	Select Nailed-Up if you do not want the connection to time out.
Idle Timeout	Type the time in seconds that elapses before the router automatically disconnects from the PPPoE server. The default time is 100 seconds.
WAN IP Address Assignment	
IP Address Assignment	Select Dynamic if your ISP did not assign you a fixed IP address. This is the default selection. Select Static if the ISP assigned a fixed IP address. The fields below are available only when you select Static .
My WAN IP Address	Enter your WAN IP address in this field.
First DNS Server Second DNS Server	Enter the DNS server's IP address(es) in the field(s) to the right. Leave the field as 0.0.0.0 if you do not want to configure DNS servers. If you do not configure a DNS server, you must know the IP address of a machine in order to access it.
Back	Click Back to return to the previous wizard screen.
Apply	Click Apply to save your changes and go to the next screen.

3.2.1.3 PPTP Encapsulation

Point-to-Point Tunneling Protocol (PPTP) is a network protocol that enables transfers of data from a remote client to a private server, creating a Virtual Private Network (VPN) using TCP/IP-based networks.

PPTP supports on-demand, multi-protocol, and virtual private networking over public networks, such as the Internet.



The ZyWALL supports one PPTP server connection at any given time.

Figure 17 ISP Parameters: PPTP Encapsulation

WIZARD - Internet Access

ISP Parameters for Internet Access

You can select ethernet, PPPoE or PPTP according to in which the network you are. If you don't know, please ask your network administrator. The most popular type of network is ethernet.

Encapsulation: PPTP

User Name: _____

Password: _____

Retype to Confirm: _____

Nailed-Up

Idle Timeout: 100 (Seconds)

PPTP Configuration

My IP Address: 0 . 0 . 0 . 0

My IP Subnet Mask: 0 . 0 . 0 . 0

Server IP Address: 0 . 0 . 0 . 0

Connection ID/Name: _____

WAN IP Address Assignment

IP Address Assignment: Static

My WAN IP Address: 0 . 0 . 0 . 0

First DNS Server: 0 . 0 . 0 . 0

Second DNS Server: 0 . 0 . 0 . 0

Back Apply

The following table describes the labels in this screen.

Table 12 ISP Parameters: PPTP Encapsulation

LABEL	DESCRIPTION
ISP Parameters for Internet Access	
Encapsulation	Select PPTP from the drop-down list box. To configure a PPTP client, you must configure the User Name and Password fields for a PPP connection and the PPTP parameters for a PPTP connection.
User Name	Type the user name given to you by your ISP.
Password	Type the password associated with the User Name above.
Retype to Confirm	Type your password again for confirmation.
Nailed-Up	Select Nailed-Up if you do not want the connection to time out.
Idle Timeout	Type the time in seconds that elapses before the router automatically disconnects from the PPTP server.
PPTP Configuration	
My IP Address	Type the (static) IP address assigned to you by your ISP.

Table 12 ISP Parameters: PPTP Encapsulation

LABEL	DESCRIPTION
My IP Subnet Mask	Type the subnet mask assigned to you by your ISP (if given).
Server IP Address	Type the IP address of the PPTP server.
Connection ID/ Name	Enter the connection ID or connection name in this field. It must follow the "c:id" and "n:name" format. For example, C:12 or N:My ISP. This field is optional and depends on the requirements of your xDSL modem.
WAN IP Address Assignment	
IP Address Assignment	Select Dynamic if your ISP did not assign you a fixed IP address. This is the default selection. Select Static if the ISP assigned a fixed IP address. The fields below are available only when you select Static .
My WAN IP Address	Enter your WAN IP address in this field.
First DNS Server Second DNS Server	Enter the DNS server's IP address(es) in the field(s) to the right. Leave the field as 0.0.0.0 if you do not want to configure DNS servers. If you do not configure a DNS server, you must know the IP address of a machine in order to access it.
Back	Click Back to return to the previous wizard screen.
Apply	Click Apply to save your changes and go to the next screen.

3.2.2 Internet Access Wizard: Second Screen

Click **Next** to go to the screen where you can register your ZyWALL and activate the free content filtering trial application. Otherwise, click **Skip** to display the congratulations screen and click **Close** to complete the Internet access setup.

Figure 18 Internet Access Wizard: Second Screen

Figure 19 Internet Access Setup Complete

3.2.3 Internet Access Wizard: Registration

If you clicked **Next** in the previous screen (see [Figure 18 on page 72](#)), the following screen displays.

Use this screen to register the ZyWALL with myZyXEL.com. You must register your ZyWALL before you can activate trial application of service like content filtering.



If you want to activate a standard service with your iCard's PIN number (license key), use the REGISTRATION > Service screen.

Figure 20 Internet Access Wizard: Registration

The following table describes the labels in this screen.

Table 13 Internet Access Wizard: Registration

LABEL	DESCRIPTION
Device Registration	If you select Existing myZyXEL.com account , only the User Name and Password fields are available.
New myZyXEL.com account	If you haven't created an account at myZyXEL.com, select this option and configure the following fields to create an account and register your ZyWALL.
Existing myZyXEL.com account	If you already have an account at myZyXEL.com, select this option and enter your user name and password in the fields below to register your ZyWALL.
User Name	Enter a user name for your myZyXEL.com account. The name should be from six to 20 alphanumeric characters (and the underscore). Spaces are not allowed.
Check	Click this button to check with the myZyXEL.com database to verify the user name you entered has not been used.
Password	Enter a password of between six and 20 alphanumeric characters (and the underscore). Spaces are not allowed.
Confirm Password	Enter the password again for confirmation.
E-Mail Address	Enter your e-mail address. You can use up to 80 alphanumeric characters (periods and the underscore are also allowed) without spaces.
Country	Select your country from the drop-down box list.
Back	Click Back to return to the previous screen.
Next	Click Next to continue.

After you fill in the fields and click **Next**, the following screen shows indicating the registration is in progress. Wait for the registration progress to finish.

Figure 21 Internet Access Wizard: Registration in Progress

Click **Close** to leave the wizard screen when the registration and activation are done.

Figure 22 Internet Access Wizard: Status

The following screen appears if the registration was not successful. Click **Return** to go back to the **Device Registration** screen and check your settings.

Figure 23 Internet Access Wizard: Registration Failed

If the ZyWALL has been registered, the **Device Registration** screen is read-only and the **Service Activation** screen appears indicating what trial applications are activated after you click **Next**.

Figure 24 Internet Access Wizard: Registered Device

INTERNET ACCESS

Device Registration

Existing myZyXEL.com account

User Name

Password (Type username and password from 6 to 20 characters.)

Figure 25 Internet Access Wizard: Activated Services

INTERNET ACCESS

Service Activation

Service to be activated

Content Filtering 1-month Trial (Service has been activated.)

3.3 VPN Wizard Gateway Setting

Use this screen to name the VPN gateway policy (IKE SA) and identify the IPSec routers at either end of the VPN tunnel.

Click **VPN Setup** in the **Wizard Setup Welcome** screen ([Figure 14 on page 67](#)) to open the VPN configuration wizard. The first screen displays as shown next.

Figure 26 VPN Wizard: Gateway Setting

The screenshot shows a web-based configuration interface for a VPN gateway. It is titled "WIZARD - VPN". There are two main sections: "Gateway Policy Property" and "Gateway Policy Setting". Under "Gateway Policy Property", there is a "Name" field. Under "Gateway Policy Setting", there are two fields: "My ZyWALL" and "Remote Gateway Address", both of which currently contain the IP address "0.0.0.0". At the bottom right of the form, there are two buttons labeled "Back" and "Next".

The following table describes the labels in this screen.

Table 14 VPN Wizard: Gateway Setting

LABEL	DESCRIPTION
Gateway Policy Property	
Name	Type up to 32 characters to identify this VPN gateway policy. You may use any character, including spaces, but the ZyWALL drops trailing spaces.
Gateway Policy Setting	
My ZyWALL	When the ZyWALL is in router mode, enter the WAN IP address or the domain name of your ZyWALL or leave the field set to 0.0.0.0 . The ZyWALL uses its current WAN IP address (static or dynamic) in setting up the VPN tunnel if you leave this field as 0.0.0.0 . If the WAN connection goes down, the ZyWALL uses the dial backup IP address for the VPN tunnel when using dial backup or the LAN IP address when using traffic redirect. The VPN tunnel has to be rebuilt if this IP address changes. When the ZyWALL is in bridge mode, this field is read-only and displays the ZyWALL's IP address.
Remote Gateway Address	Enter the WAN IP address or domain name of the remote IPSec router (secure gateway) in the field below to identify the remote IPSec router by its IP address or a domain name. Set this field to 0.0.0.0 if the remote IPSec router has a dynamic WAN IP address.
Back	Click Back to return to the previous screen.
Next	Click Next to continue.

3.4 VPN Wizard Network Setting

Use this screen to name the VPN network policy (IPSec SA) and identify the devices behind the IPSec routers at either end of a VPN tunnel.

Two active SAs cannot have the local and remote IP address(es) both the same. Two active SAs can have the same local or remote IP address, but not both. You can configure multiple SAs between the same local and remote IP addresses, as long as only one is active at any time.

Figure 27 VPN Wizard: Network Setting

The following table describes the labels in this screen.

Table 15 VPN Wizard: Network Setting

LABEL	DESCRIPTION
Network Policy Property	
Active	If the Active check box is selected, packets for the tunnel trigger the ZyWALL to build the tunnel. Clear the Active check box to turn the network policy off. The ZyWALL does not apply the policy. Packets for the tunnel do not trigger the tunnel.
Name	Type up to 32 characters to identify this VPN network policy. You may use any character, including spaces, but the ZyWALL drops trailing spaces.
Network Policy Setting	
Local Network	Local IP addresses must be static and correspond to the remote IPSec router's configured remote IP addresses. Select Single for a single IP address. Select Range IP for a specific range of IP addresses. Select Subnet to specify IP addresses on a network by their subnet mask.
Starting IP Address	When the Local Network field is configured to Single , enter a (static) IP address on the LAN behind your ZyWALL. When the Local Network field is configured to Range IP , enter the beginning (static) IP address, in a range of computers on the LAN behind your ZyWALL. When the Local Network field is configured to Subnet , this is a (static) IP address on the LAN behind your ZyWALL.
Ending IP Address/ Subnet Mask	When the Local Network field is configured to Single , this field is N/A. When the Local Network field is configured to Range IP , enter the end (static) IP address, in a range of computers on the LAN behind your ZyWALL. When the Local Network field is configured to Subnet , this is a subnet mask on the LAN behind your ZyWALL.

Table 15 VPN Wizard: Network Setting

LABEL	DESCRIPTION
Remote Network	Remote IP addresses must be static and correspond to the remote IPSec router's configured local IP addresses. Select Single for a single IP address. Select Range IP for a specific range of IP addresses. Select Subnet to specify IP addresses on a network by their subnet mask.
Starting IP Address	When the Remote Network field is configured to Single , enter a (static) IP address on the network behind the remote IPSec router. When the Remote Network field is configured to Range IP , enter the beginning (static) IP address, in a range of computers on the network behind the remote IPSec router. When the Remote Network field is configured to Subnet , enter a (static) IP address on the network behind the remote IPSec router
Ending IP Address/ Subnet Mask	When the Remote Network field is configured to Single , this field is N/A. When the Remote Network field is configured to Range IP , enter the end (static) IP address, in a range of computers on the network behind the remote IPSec router. When the Remote Network field is configured to Subnet , enter a subnet mask on the network behind the remote IPSec router.
Back	Click Back to return to the previous screen.
Next	Click Next to continue.

3.5 VPN Wizard IKE Tunnel Setting (IKE Phase 1)

Use this screen to specify the authentication, encryption and other settings needed to negotiate a phase 1 IKE SA.

Figure 28 VPN Wizard: IKE Tunnel Setting

The screenshot shows the 'WIZARD - VPN' interface with the 'IKE Tunnel Setting (IKE Phase 1)' sub-screen. The settings are as follows:

- Negotiation Mode:** Main Mode Aggressive Mode
- Encryption Algorithm:** DES AES 3DES
- Authentication Algorithm:** SHA1 MD5
- Key Group:** DH1 DH2
- SA Life Time:** 28800 (Seconds)
- Pre-Shared Key:** 12345678

At the bottom right, there are 'Back' and 'Next' buttons.

The following table describes the labels in this screen.

Table 16 VPN Wizard: IKE Tunnel Setting

LABEL	DESCRIPTION
Negotiation Mode	Select Main Mode for identity protection. Select Aggressive Mode to allow more incoming connections from dynamic IP addresses to use separate passwords. Note: Multiple SAs (security associations) connecting through a secure gateway must have the same negotiation mode.
Encryption Algorithm	When DES is used for data communications, both sender and receiver must know the same secret key, which can be used to encrypt and decrypt the message or to generate and verify a message authentication code. The DES encryption algorithm uses a 56-bit key. Triple DES (3DES) is a variation on DES that uses a 168-bit key. As a result, 3DES is more secure than DES . It also requires more processing power, resulting in increased latency and decreased throughput. This implementation of AES uses a 128-bit key. AES is faster than 3DES .
Authentication Algorithm	MD5 (Message Digest 5) and SHA1 (Secure Hash Algorithm) are hash algorithms used to authenticate packet data. The SHA1 algorithm is generally considered stronger than MD5 , but is slower. Select MD5 for minimal security and SHA-1 for maximum security.
Key Group	You must choose a key group for phase 1 IKE setup. DH1 (default) refers to Diffie-Hellman Group 1 a 768 bit random number. DH2 refers to Diffie-Hellman Group 2 a 1024 bit (1Kb) random number.
SA Life Time (Seconds)	Define the length of time before an IKE SA automatically renegotiates in this field. The minimum value is 180 seconds. A short SA Life Time increases security by forcing the two VPN gateways to update the encryption and authentication keys. However, every time the VPN tunnel renegotiates, all users accessing remote resources are temporarily disconnected.
Pre-Shared Key	Type your pre-shared key in this field. A pre-shared key identifies a communicating party during a phase 1 IKE negotiation. It is called "pre-shared" because you have to share it with another party before you can communicate with them over a secure connection. Type from 8 to 31 case-sensitive ASCII characters or from 16 to 62 hexadecimal ("0-9", "A-F") characters. You must precede a hexadecimal key with a "0x (zero x)", which is not counted as part of the 16 to 62 character range for the key. For example, in "0x0123456789ABCDEF", 0x denotes that the key is hexadecimal and 0123456789ABCDEF is the key itself. Both ends of the VPN tunnel must use the same pre-shared key. You will receive a PYLD_MALFORMED (payload malformed) packet if the same pre-shared key is not used on both ends.
Back	Click Back to return to the previous screen.
Next	Click Next to continue.

3.6 VPN Wizard IPSec Setting (IKE Phase 2)

Use this screen to specify the authentication, encryption and other settings needed to negotiate a phase 2 IPSec SA.

Figure 29 VPN Wizard: IPsec Setting

WIZARD - VPN

IPsec Setting (IKE Phase 2)

Encapsulation Mode Tunnel Transport

IPSec Protocol ESP AH

Encryption Algorithm DES AES 3DES NULL

Authentication Algorithm SHA1 MD5

SA Life Time (Seconds)

Perfect Forward Secrecy (PFS) None DH1 DH2

Back Next

The following table describes the labels in this screen.

Table 17 VPN Wizard: IPsec Setting

LABEL	DESCRIPTION
Encapsulation Mode	Tunnel is compatible with NAT, Transport is not. Tunnel mode encapsulates the entire IP packet to transmit it securely. A Tunnel mode is required for gateway services to provide access to internal systems. Tunnel mode is fundamentally an IP tunnel with authentication and encryption. Transport mode is used to protect upper layer protocols and only affects the data in the IP packet. In Transport mode, the IP packet contains the security protocol (AH or ESP) located after the original IP header and options, but before any upper layer protocols contained in the packet (such as TCP and UDP).
IPSec Protocol	Select the security protocols used for an SA. Both AH and ESP increase ZyWALL processing requirements and communications latency (delay).
Encryption Algorithm	When DES is used for data communications, both sender and receiver must know the same secret key, which can be used to encrypt and decrypt the message or to generate and verify a message authentication code. The DES encryption algorithm uses a 56-bit key. Triple DES (3DES) is a variation on DES that uses a 168-bit key. As a result, 3DES is more secure than DES . It also requires more processing power, resulting in increased latency and decreased throughput. This implementation of AES uses a 128-bit key. AES is faster than 3DES . Select NULL to set up a tunnel without encryption. When you select NULL , you do not enter an encryption key.
Authentication Algorithm	MD5 (Message Digest 5) and SHA1 (Secure Hash Algorithm) are hash algorithms used to authenticate packet data. The SHA1 algorithm is generally considered stronger than MD5 , but is slower. Select MD5 for minimal security and SHA-1 for maximum security.
SA Life Time (Seconds)	Define the length of time before an IKE SA automatically renegotiates in this field. The minimum value is 180 seconds. A short SA Life Time increases security by forcing the two VPN gateways to update the encryption and authentication keys. However, every time the VPN tunnel renegotiates, all users accessing remote resources are temporarily disconnected.

Table 17 VPN Wizard: IPSec Setting (continued)

LABEL	DESCRIPTION
Perfect Forward Secret (PFS)	Perfect Forward Secret (PFS) is disabled (None) by default in phase 2 IPSec SA setup. This allows faster IPSec setup, but is not so secure. Select DH1 or DH2 to enable PFS. DH1 refers to Diffie-Hellman Group 1 a 768 bit random number. DH2 refers to Diffie-Hellman Group 2 a 1024 bit (1Kb) random number (more secure, yet slower).
Back	Click Back to return to the previous screen.
Next	Click Next to continue.

3.7 VPN Wizard Status Summary

This read-only screen shows the status of the current VPN setting. Use the summary table to check whether what you have configured is correct.

Figure 30 VPN Wizard: VPN Status

WIZARD - VPN

Status

Gateway Policy Property	
Name	Test
Gateway Policy Setting	
My ZyWALL	0.0.0.0
Remote Gateway Address	BranchOffice.com
Network Policy Property	
Active	Yes
Name	Test
Network Policy Setting	
Local Network	
Starting IP Address	192.168.1.0
Subnet Mask	255.255.255.0
Remote Network	
Starting IP Address	10.0.0.0
Subnet Mask	255.0.0.0
IKE Tunnel Setting (IKE Phase 1)	
Authentication For Activating VPN	
Authenticated By	
User Name	
Password	
Negotiation Mode	Main Mode
Encryption Algorithm	DES
Authentication Algorithm	MD5
Key Group	DH1
SA Life Time	28800 (Seconds)
Pre-Shared Key	12345678
IPSec Setting (IKE Phase 2)	
Encapsulation Mode	Tunnel Mode
IPSec Protocol	ESP
Encryption Algorithm	DES
Authentication Algorithm	SHA1
SA Life Time	28800 (Seconds)
Perfect Forward Secrecy (PFS)	None

Back Finish

The following table describes the labels in this screen.

Table 18 VPN Wizard: VPN Status

LABEL	DESCRIPTION
Gateway Policy Property	
Name	This is the name of this VPN gateway policy.
Gateway Policy Setting	
My ZyWALL	This is the WAN IP address or the domain name of your ZyWALL in router mode or the ZyWALL's IP address in bridge mode.
Remote Gateway Address	This is the IP address or the domain name used to identify the remote IPSec router.
Network Policy Property	
Active	This displays whether this VPN network policy is enabled or not.
Name	This is the name of this VPN network policy.
Network Policy Setting	
Local Network	
Starting IP Address	This is a (static) IP address on the LAN behind your ZyWALL.
Ending IP Address/ Subnet Mask	When the local network is configured for a single IP address, this field is N/A. When the local network is configured for a range IP address, this is the end (static) IP address, in a range of computers on the LAN behind your ZyWALL. When the local network is configured for a subnet, this is a subnet mask on the LAN behind your ZyWALL.
Remote Network	
Starting IP Address	This is a (static) IP address on the network behind the remote IPSec router.
Ending IP Address/ Subnet Mask	When the remote network is configured for a single IP address, this field is N/A. When the remote network is configured for a range IP address, this is the end (static) IP address, in a range of computers on the network behind the remote IPSec router. When the remote network is configured for a subnet, this is a subnet mask on the network behind the remote IPSec router.
IKE Tunnel Setting (IKE Phase 1)	
Negotiation Mode	This shows Main Mode or Aggressive Mode . Multiple SAs connecting through a secure gateway must have the same negotiation mode.
Encryption Algorithm	This is the method of data encryption. Options can be DES , 3DES or AES .
Authentication Algorithm	MD5 (Message Digest 5) and SHA1 (Secure Hash Algorithm) are hash algorithms used to authenticate packet data.
Key Group	This is the key group you chose for phase 1 IKE setup.
SA Life Time (Seconds)	This is the length of time before an IKE SA automatically renegotiates.
Pre-Shared Key	This is a pre-shared key identifying a communicating party during a phase 1 IKE negotiation.
IPSec Setting (IKE Phase 2)	
Encapsulation Mode	This shows Tunnel mode or Transport mode.

Table 18 VPN Wizard: VPN Status (continued)

LABEL	DESCRIPTION
IPSec Protocol	ESP or AH are the security protocols used for an SA.
Encryption Algorithm	This is the method of data encryption. Options can be DES , 3DES , AES or NULL .
Authentication Algorithm	MD5 (Message Digest 5) and SHA1 (Secure Hash Algorithm) are hash algorithms used to authenticate packet data.
SA Life Time (Seconds)	This is the length of time before an IKE SA automatically renegotiates.
Perfect Forward Secret (PFS)	Perfect Forward Secret (PFS) is disabled (None) by default in phase 2 IPSec SA setup. Otherwise, DH1 or DH2 are selected to enable PFS.
Back	Click Back to return to the previous screen.
Finish	Click Finish to complete and save the wizard setup.

3.8 VPN Wizard Setup Complete

Congratulations! You have successfully set up the VPN rule for your ZyWALL. If you already had VPN rules configured, the wizard adds the new VPN rule after the last existing VPN rule.

Figure 31 VPN Wizard Setup Complete

Tutorial

This chapter describes how to apply security settings to VPN traffic, how to set up your ZyWALL if you have more than one fixed (static) IP address from your ISP and how to allocate bandwidth and apply priorities to traffic that flows out through the ZyWALL's WAN port.

4.1 Security Settings for VPN Traffic

The ZyWALL can apply the firewall and content filtering to the traffic going to or from the ZyWALL's VPN tunnels. The ZyWALL applies the security settings to the traffic before encrypting VPN traffic that it sends out or after decrypting received VPN traffic.



The security settings apply to VPN traffic going to or from the ZyWALL's VPN tunnels. They do not apply to other VPN traffic for which the ZyWALL is not one of the gateways (VPN pass-through traffic).

You can turn on content filtering for all of the ZyWALL's VPN traffic (regardless of its direction of travel). You can apply firewall security to VPN traffic based on its direction of travel. The following examples show how you do this for the firewall.

4.1.1 Firewall Rule for VPN Example

The firewall provides even more fine-tuned control for VPN tunnels. You can configure default and custom firewall rules for VPN packets.

Take the following example. You have a LAN FTP server with IP address 192.168.1.4 behind device A. You could configure a VPN rule to allow the network behind device B to access your LAN FTP server through a VPN tunnel. Now, if you don't want other services like chat or e-mail going to the FTP server, you can configure firewall rules that allow only FTP traffic to come from VPN tunnels to the FTP server. Furthermore, you can configure the firewall rule so that only the network behind device B can access the FTP server through a VPN tunnel (not other remote networks that have VPN tunnels with the ZyWALL).

Figure 32 Firewall Rule for VPN

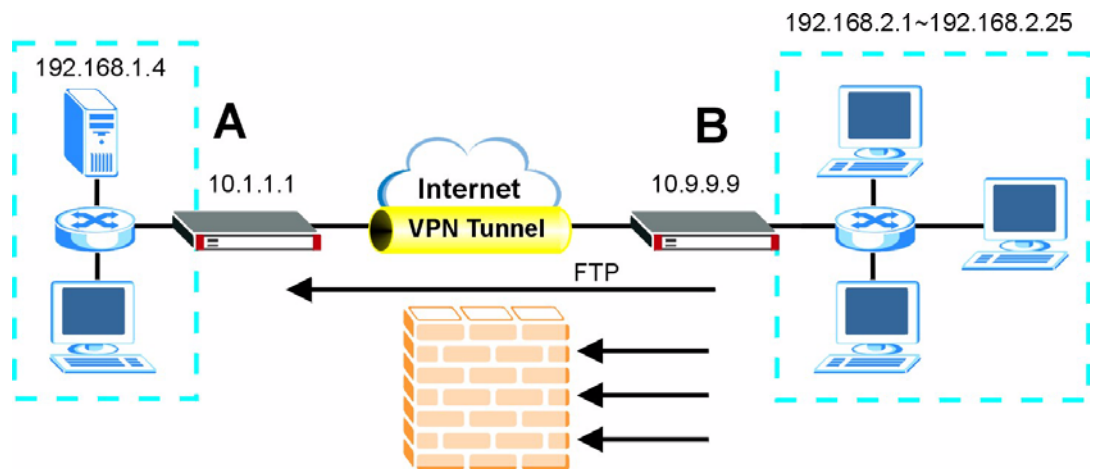

4.1.2 Configuring the VPN Rule

This section shows how to configure a VPN rule on device A to let the network behind B access the FTP server. You would also have to configure a corresponding rule on device B.

- 1 Click **Security > VPN** to open the following screen. Click the **Add Gateway Policy** icon.

Figure 33 SECURITY > VPN > VPN Rules (IKE)

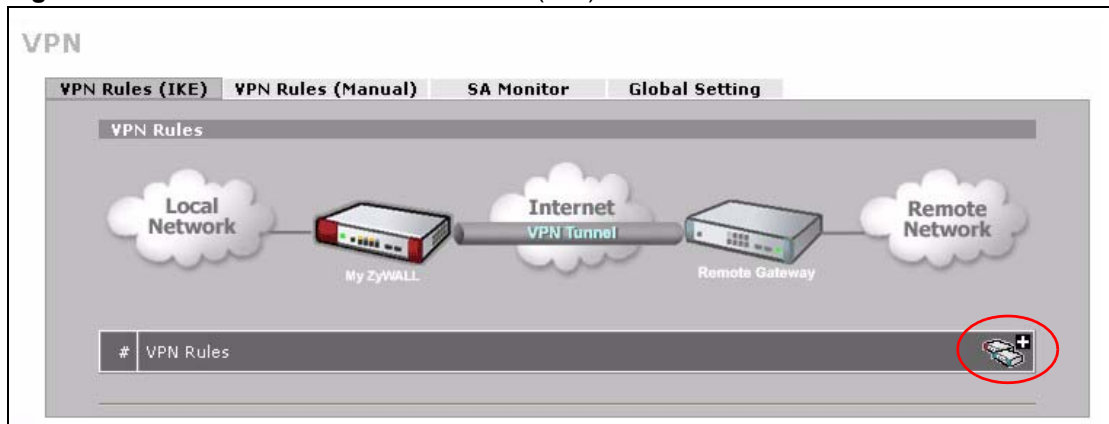

- 2 Use this screen to set up the connection between the routers. Configure the fields that are circled as follows and click **Apply**.

Figure 34 SECURITY > VPN > VPN Rules (IKE)> Add Gateway Policy

VPN - GATEWAY POLICY - EDIT

Property

Name

NAT Traversal

Gateway Policy Information

My ZyWALL

My Address (Domain Name or IP Address)

My Domain Name (See [DDNS](#))

Primary Remote Gateway (Domain Name or IP Address)

Enable IPSec High Availability

Redundant Remote Gateway (Domain Name or IP Address)

Fail back to Primary Remote Gateway when possible

Fail Back Check Interval* (180~86400 seconds)

*Fail Back Check Interval: The time interval for checking availability of Primary Remote Gateway. IPSec SA life time will be superseded by this value when it is larger than this value.

Authentication Key

Pre-Shared Key

Certificate (See [My Certificates](#))

Local ID Type

Content

Peer ID Type

Content

Extended Authentication

Enable Extended Authentication

Server Mode (Search [Local User](#) first then [RADIUS](#))

Client Mode

User Name

Password

IKE Proposal

Negotiation Mode

Encryption Algorithm

Authentication Algorithm

SA Life Time (Seconds)

Key Group

Enable Multiple Proposals

Associated Network Policies

#	Name	Local Network	Remote Network

3 Click the **Add Network Policy** icon.

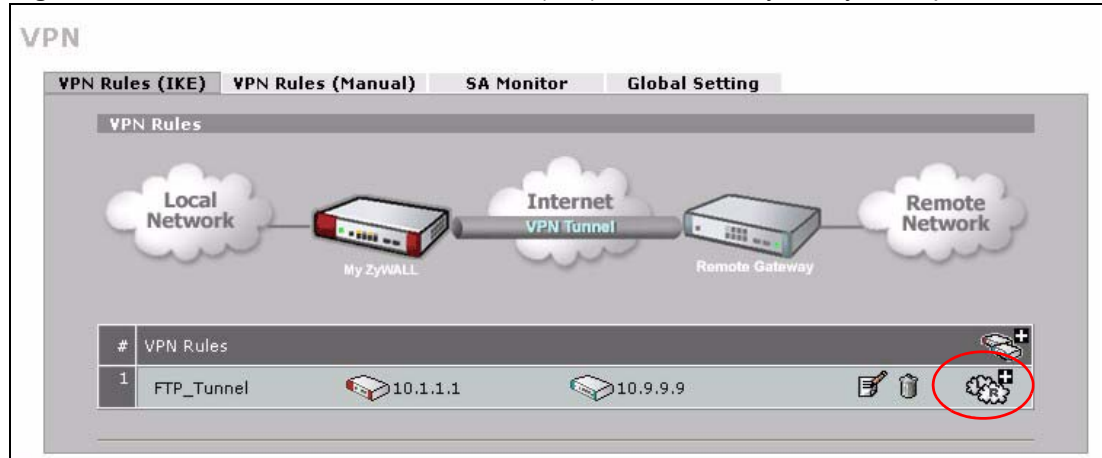
Figure 35 SECURITY > VPN > VPN Rules (IKE): With Gateway Policy Example

- 4 Use this screen to specify which computers behind the routers can use the VPN tunnel. Configure the fields that are circled as follows and click **Apply**. You may notice that the example does not specify the port numbers. This is due to the following reasons.
- While FTP uses a control session on port 20, the port for the data session is not fixed. So this example uses the firewall's FTP application layer gateway (ALG) to handle this instead of specifying port numbers in this VPN network policy.
 - The firewall provides better security because it operates at layer 4 and checks traffic sessions. The VPN network policy only operates at layer 3 and just checks IP addresses and port numbers.

Figure 36 SECURITY > VPN > VPN Rules (IKE)> Add Network Policy

VPN - NETWORK POLICY - EDIT

Property

Active

Name: FTP_Server

Protocol: 21

Nailed-Up

Allow NetBIOS broadcast Traffic Through IPsec Tunnel

Check IPsec Tunnel Connectivity Log

Ping this Address: 0 . 0 . 0 . 0

Gateway Policy Information

Gateway Policy: FTP_Tunnel

Local Network

Address Type: Single Address

Starting IP Address: 192 . 168 . 1 . 4

Ending IP Address / Subnet Mask: 0 . 0 . 0 . 0

Local Port: Start 0 End 0

Remote Network

Address Type: Range Address

Starting IP Address: 192 . 168 . 2 . 1

Ending IP Address / Subnet Mask: 192 . 168 . 2 . 25

Remote Port: Start 0 End 0

IPsec Proposal

Encapsulation Mode: Tunnel

Active Protocol: ESP

Encryption Algorithm: DES

Authentication Algorithm: SHA1

SA Life Time (Seconds): 28800

Perfect Forward Secrecy (PFS): NONE

Enable Replay Detection

Enable Multiple Proposals

Apply Cancel

4.1.3 Configuring the Firewall Rules

Suppose you have several VPN tunnels but you only want to allow device B's network to access the FTP server. You also only want FTP traffic to go to the FTP server, so you want to block all other traffic types (like chat, e-mail, web and so on). The following sections show how to configure firewall rules to enforce these restrictions.

4.1.3.1 Firewall Rule to Allow Access Example

Configure a firewall rule that allows FTP access from the VPN tunnel to the FTP server.

- 1 Click **Security > Firewall > Rule Summary**.
- 2 Select **VPN to LAN** as the packet direction and click **Insert**.

Figure 37 SECURITY > FIREWALL > Rule Summary

FIREWALL

Default Rule | **Rule Summary** | Anti-Probing | Threshold | Service

Rule Summary

Firewall Rules Storage Space in Use
0% 100%

Packet Direction:

Default Policy: Permit, None Log

#	Name	Active	Source Address	Destination Address	Service Type	Action	Sch.	Log	Modify
---	------	--------	----------------	---------------------	--------------	--------	------	-----	--------

new rule before rule (rule number)

rule to rule (rule number)

- 3 Configure the rule as follows and click **Apply**. The source addresses are the VPN rule's remote network and the destination address is the LAN FTP server.

Figure 38 SECURITY > FIREWALL > Rule Summary > Edit: Allow

FIREWALL - EDIT RULE

Rule Name: VPN-to-FTP-Allow

Edit Source Address

Address Editor

Address Type: Any Address

Start IP Address: 0 . 0 . 0 . 0

End IP Address: 0 . 0 . 0 . 0

Subnet Mask: 0 . 0 . 0 . 0

[Add] [Modify] [Delete]

Source Address(es): 192.168.2.1 - 192.168.2.25

Edit Destination Address

Address Editor

Address Type: Any Address

Start IP Address: 0 . 0 . 0 . 0

End IP Address: 0 . 0 . 0 . 0

Subnet Mask: 0 . 0 . 0 . 0

[Add] [Modify] [Delete]

Destination Address(es): 192.168.1.4

Edit Service

Available Services (See [Service](#))

- FINGER(TCP:79)
- H.323(TCP:1720)
- HTTP(TCP:80)
- HTTPS(TCP:443)
- ICQ(UDP:4000)
- IKE(UDP:500)
- IMAP(TCP/UDP:143)
- IMAPS(TCP/UDP:993)
- IP(A.X.25:0)
- IP(IPv6:0)
- IPSEC_TRANSPORT/TUNNEL(AH:0)
- IPSEC_TUNNEL(ESP:0)
- IRC(TCP/UDP:6667)
- MULTICAST(IGMP:0)
- MSN(TCP:1863)

Selected Service(s): FTP(TCP:20,21)

Edit Schedule

Day to Apply:

Sun Mon Tue Wed Thu Fri Sat

Time of Day to Apply: (24-Hour Format)

All day

Start: 0 (Hour) 0 (Minute) End: 0 (Hour) 0 (Minute)

Actions When Matched

Log Packet Information When Matched

Send Alert Message to Administrator When Matched

Action for Matched Packets: Permit

[Apply] [Cancel]

4 The rule displays in the summary list of VPN to LAN firewall rules.

Figure 39 SECURITY > FIREWALL > Rule Summary: Allow

FIREWALL

Default Rule Rule Summary Anti-Probing Threshold Service

Rule Summary

Firewall Rules Storage Space in Use
0% 100%

Packet Direction:

Default Policy: Permit, None Log

#	Name	Active	Source Address	Destination Address	Service Type	Action	Sch.	Log	Modify
1	VPN-to-FTP-Allow	<input checked="" type="checkbox"/>	192.168.2.1 - 192.168.2.25	192.168.1.4	FTP(TCP:20,21)	Permit	No	No	

Insert new rule before rule (rule number)

Move rule to rule (rule number)

4.1.3.2 Default Firewall Rule to Block Other Access Example

Now you configure the default firewall rule to block all VPN to LAN traffic. This blocks any other types of access from VPN tunnels to the LAN FTP server. This means that you need to configure more firewall rules if you want to allow any other VPN tunnels to access the LAN.

- 1 Click **SECURITY > FIREWALL > Default Rule**.
- 2 Configure the screen as follows and click **Apply**.

Figure 40 SECURITY > FIREWALL > Default Rule: Block From VPN To LAN

FIREWALL

Default Rule Rule Summary Anti-Probing Threshold Service

Default Rule Setup

Enable Firewall

Allow Asymmetrical Route (Warning: When this box is checked, all LAN to LAN, WAN to WAN, DMZ to DMZ, WLAN to WLAN, and VPN to VPN packets will bypass the Firewall check.)

From \ To	LAN	WAN	DMZ	WLAN	VPN
LAN	Permit <input type="checkbox"/>	Permit <input type="checkbox"/>	Permit <input checked="" type="checkbox"/>	Drop <input checked="" type="checkbox"/>	Permit <input type="checkbox"/>
WAN	Drop <input checked="" type="checkbox"/>	Drop <input checked="" type="checkbox"/>	Permit <input checked="" type="checkbox"/>	Permit <input type="checkbox"/>	Permit <input type="checkbox"/>
DMZ	Drop <input checked="" type="checkbox"/>	Permit <input checked="" type="checkbox"/>	Drop <input checked="" type="checkbox"/>	Drop <input checked="" type="checkbox"/>	Permit <input type="checkbox"/>
WLAN	Drop <input checked="" type="checkbox"/>	Permit <input type="checkbox"/>	Drop <input checked="" type="checkbox"/>	Drop <input checked="" type="checkbox"/>	Permit <input type="checkbox"/>
VPN	Drop <input checked="" type="checkbox"/>	Permit <input type="checkbox"/>	Permit <input type="checkbox"/>	Permit <input type="checkbox"/>	Permit <input type="checkbox"/>

* Log

Apply Reset

4.2 Using NAT with Multiple Public IP Addresses

This section shows you examples of how to set up your ZyWALL if you have more than one fixed (static) IP address from your ISP.

4.2.1 Example Parameters and Scenario

The following table shows the public IP addresses from your ISP and your ZyWALL's LAN IP address.

Public IP Addresses	1.2.3.4 to 1.2.3.7
ZyWALL's LAN IP Address	192.168.1.1

The following figure shows the network you want to set up in this example.

- Assign the first public address (1.2.3.4) to the ZyWALL's WAN port.
- Map the second and third public IP addresses (1.2.3.5 and 1.2.3.6) to the web and mail servers (192.168.1.12 and 192.168.1.13) respectively for traffic in both directions.
- Map the first public address (1.2.3.4) to outgoing traffic from other local computers.
- Map the first public address (1.2.3.4) to incoming traffic from the WAN.
- Forward FTP traffic using port 21 from the WAN to a specific local computer (192.168.1.39).
- The last public IP address (1.2.3.7) is not mapped to any device and is reserved for future use.

Figure 41 Tutorial Example: Using NAT with Static Public IP Addresses

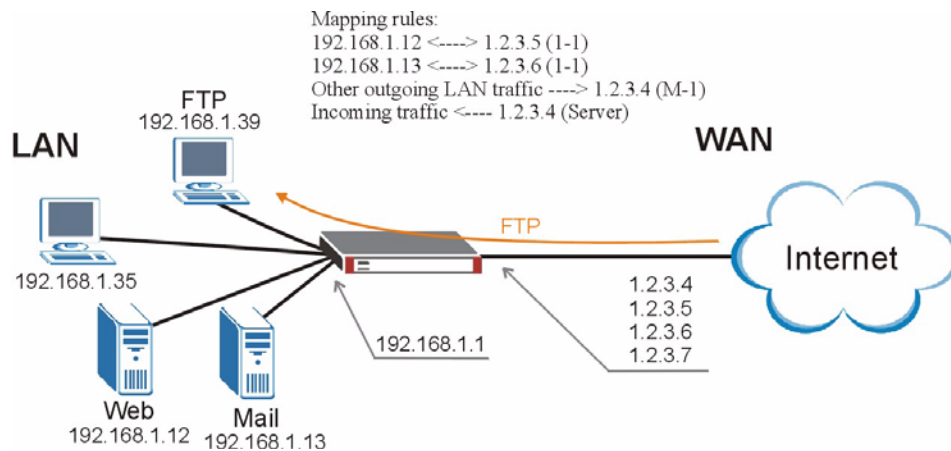

To set up this network, we are going to:

- 1 Configure the WAN connection to use the first public IP address (1.2.3.4).
- 2 Configure NAT address mapping for other public IP addresses (1.2.3.5 and 1.2.3.6).
- 3 Configure NAT port forwarding to forward FTP traffic from the WAN to a specific computer on your local network.

4.2.2 Configuring the WAN Connection with a Static IP Address

The following table shows the information your ISP gave you for Internet connection.

Encapsulation	PPPoE
Public IP Addresses	1.2.3.4 1.2.3.5 1.2.3.6 1.2.3.7
Gateway IP Address	1.2.3.89
Subnet Mask	255.255.255.0
User Name	exampleuser
Password	abcd1234
DNS Server	1.2.1.1 1.2.1.2

Follow the steps below to configure your ZyWALL for Internet access using PPPoE in this example.

Figure 42 Tutorial Example: WAN Connection with a Static Public IP Address

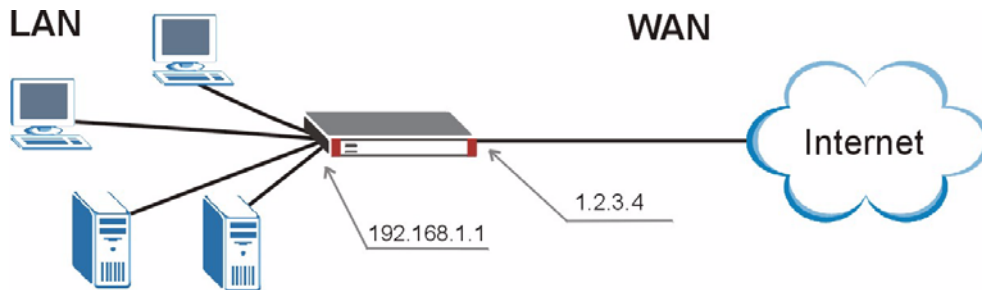

- 4** Select **PPPoE (PPP over Ethernet)** from the **Encapsulation** drop-down list box.
- 5** In the **ISP Parameters for Internet Access** section, enter the information (such as the user name and password) provided by your ISP. If your ISP didn't give you the service name, leave the field blank.
- 6** In the **WAN IP Address Assignment** section, select **Use Fixed IP Address** and enter the first fixed public IP address (1.2.3.4 in this example).
- 7** Click **Apply**.

Figure 43 Tutorial Example: WAN Screen

WAN

Route | **WAN** | Traffic Redirect | Dial Backup

ISP Parameters for Internet Access

Encapsulation: PPP over Ethernet

Service Name: (Optional)

User Name: exampleuser

Password: *****

Retype to Confirm: *****

Authentication Type: CHAP/PAP

Nailed-Up

Idle Timeout: 100 (Seconds)

WAN IP Address Assignment

Get Automatically from ISP

Use Fixed IP Address

My WAN IP Address: 1 . 2 . 3 . 4

Advanced Setup

Enable NAT (Network Address Translation)

RIP Direction: None

RIP Version: RIP-1

Enable Multicast

Multicast Version: IGMP-v1

Spoof WAN MAC Address from LAN

Clone the computer's MAC address - IP Address: 192 . 168 . 1 . 33

Apply | Reset

8 Click **ADVANCED > DNS**.

9 The **System** screen displays. Click the **Insert** button to configure the IP address of the DNS server the ZyWALL can query to resolve domain names.

Figure 44 Tutorial Example: DNS > System

DNS

System | Cache | DHCP | DDNS

Address Record

#	FQDN	Wildcard	IP Address	Modify
-	-	-	-	-

Add

Name Server Record

#	Domain Zone	From	DNS Server	Modify
-	*	Default	None	N/A
Insert	new record before record 1		(record number)	

10 Select **Public DNS Server** and enter the first DNS server's IP address given by your ISP. Click **Apply**.

Figure 45 Tutorial Example: DNS > System Edit-1

DNS - EDIT NAME SERVER RECORD

Name Server Record

Domain Zone*

* Optional. Leave this field blank if all domain zones are served by the specified DNS server(s).

DNS Server

DNS Server(s) from ISP

First DNS Server	Second DNS Server	Third DNS Server
N/A	N/A	N/A

Public DNS Server

Private DNS Server

11 Enter the rule number (2) where you want to put the second record and click the **Insert** button to configure the second DNS server's IP address as follows. Click **Apply**.

Note: To resolve a domain name, theZyWALL checks it against the name server record entries in the order that they appear in this list.

Figure 46 Tutorial Example: DNS > System Edit-2

DNS - EDIT NAME SERVER RECORD

Name Server Record

Domain Zone*

* Optional. Leave this field blank if all domain zones are served by the specified DNS server(s).

DNS Server

DNS Server(s) from ISP

First DNS Server	Second DNS Server	Third DNS Server
N/A	N/A	N/A

Public DNS Server

Private DNS Server

12 The **DNS > System** screen should look as shown.

Figure 47 Tutorial Example: DNS > System: Done

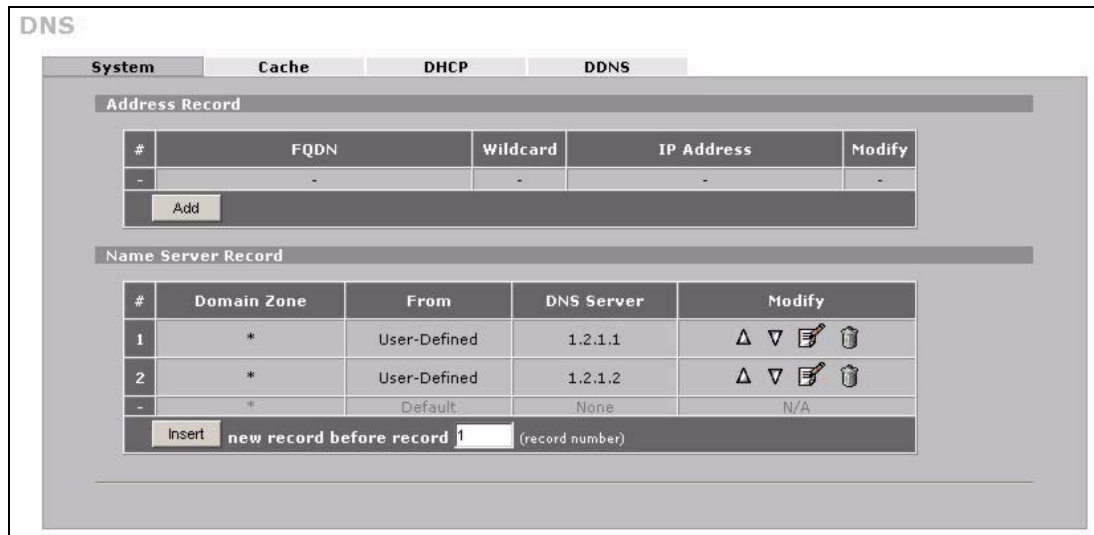

13 Go to the **Home** screen to check your WAN connection status. Make sure the status is not down.

Figure 48 Tutorial Example: Status

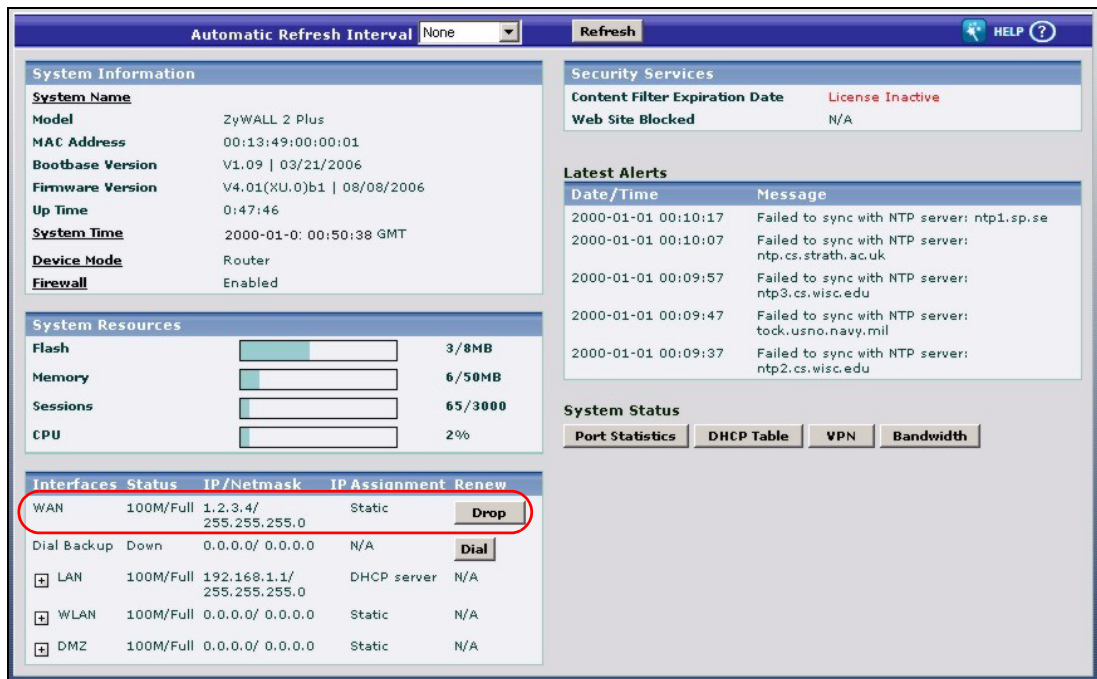

4.2.3 Public IP Address Mapping

To have the local computers and servers use specific WAN IP addresses, you need to map static public IP addresses to them.

Note: The one-to-one NAT address mapping rules are for both incoming and outgoing connections. The ZyWALL forwards traffic that is initiated from either the LAN or the WAN to the destination IP address.

The many-to-one or many-to-many NAT address mapping rules are for outgoing connections only. That means only traffic initiated from the LAN or returned packets are allowed to go through the ZyWALL.

In this example, you create two one-to-one rules to map the internal web server (192.168.1.12) and mail server (192.168.1.13) to different static public IP addresses. The many-to-one rule maps a public IP address (1.2.3.4, that is, the ZyWALL's WAN IP address) to outgoing LAN traffic. It allows other local computers on the same subnet as the ZyWALL's LAN IP address to use this IP address to access the Internet.

Figure 49 Tutorial Example: Mapping Multiple Public IP Addresses to Inside Servers

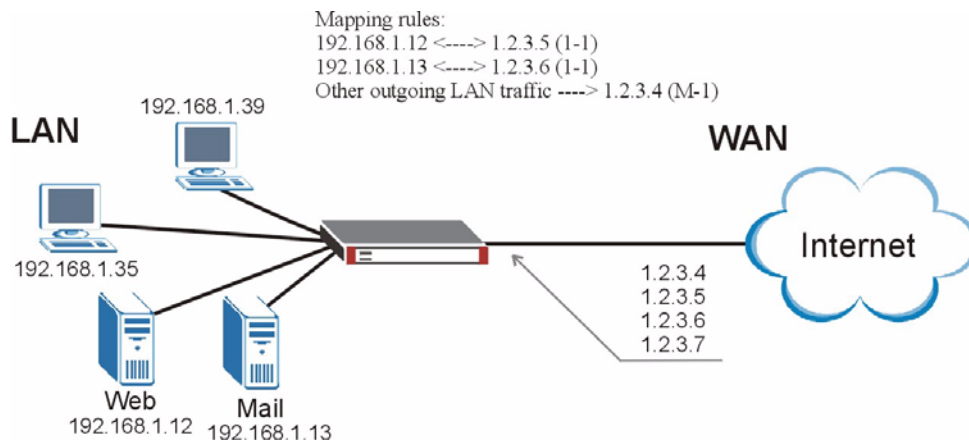

Note: The ZyWALL applies the rules in the order that you specify. You should put any one-to-one rules before a many-to-one rule.

14 Enable NAT and select **Full Feature** as you have multiple public IP addresses to map to private IP addresses. Click **Apply**.

Figure 50 Tutorial Example: NAT > NAT Overview

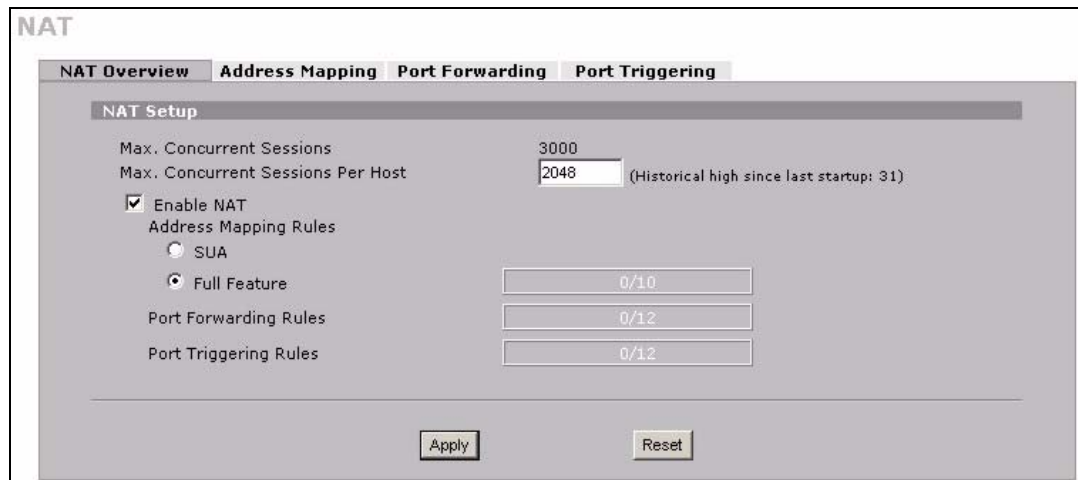

15 Click the **Address Mapping** tab.

16 Click the first rule's **Edit** icon (✎) in the **Modify** column to display the **Address Mapping Rule** screen.

Figure 51 Tutorial Example: NAT > Address Mapping

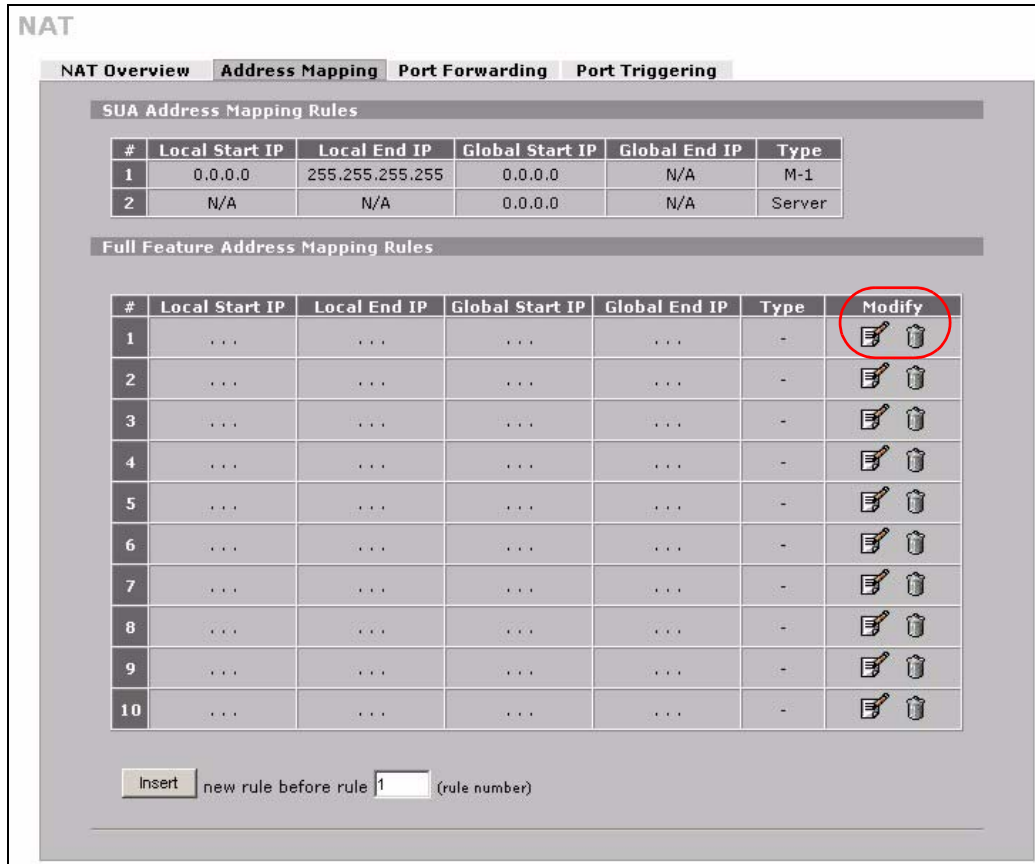

17 Map a public IP address to the web server.

Select the **One-to-One** type and enter 192.168.1.12 as the local start IP address and 1.2.3.5 as the global start IP address. Click **Apply**.

Figure 52 Tutorial Example: NAT Address Mapping Edit: One-to-One (1)

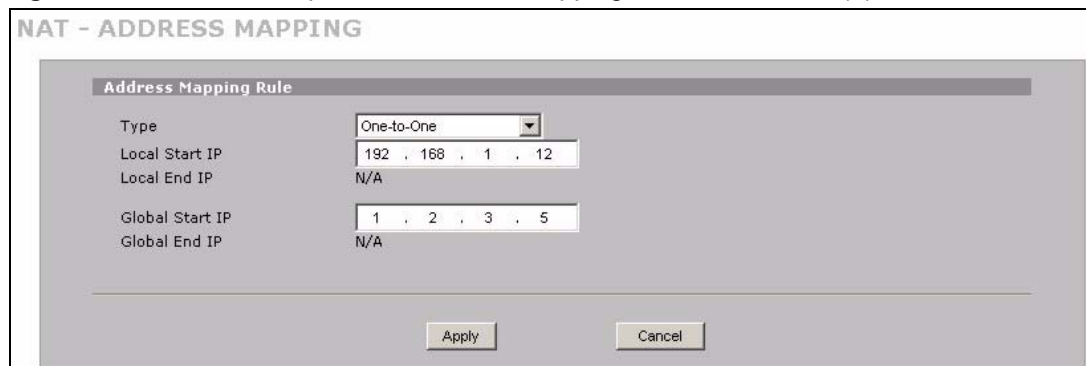

18 Click the second rule's **Edit** icon (✎).

19 Map a public IP address to the mail server.

Select the **One-to-One** type and enter 192.168.1.13 as the local start IP address and 1.2.3.6 as the global start IP address. Click **Apply**.

Figure 53 Tutorial Example: NAT Address Mapping Edit: One-to-One (2)

The screenshot shows the 'NAT - ADDRESS MAPPING' configuration window. Under the 'Address Mapping Rule' section, the 'Type' is set to 'One-to-One'. The 'Local Start IP' is '192 . 168 . 1 . 13' and the 'Local End IP' is 'N/A'. The 'Global Start IP' is '1 . 2 . 3 . 6' and the 'Global End IP' is 'N/A'. At the bottom, there are 'Apply' and 'Cancel' buttons.

20 Click the third rule's **Edit** icon (✎).

21 Map a public IP address to other outgoing LAN traffic.

Select the **Many-to-One** type and enter 192.168.1.1 as the local start IP address, 192.168.1.254 as the local end IP address and 1.2.3.4 as the global start IP address. Click **Apply**.

Figure 54 Tutorial Example: NAT Address Mapping Edit: Many-to-One

The screenshot shows the 'NAT - ADDRESS MAPPING' configuration window. Under the 'Address Mapping Rule' section, the 'Type' is set to 'Many-to-One'. The 'Local Start IP' is '192 . 168 . 1 . 1' and the 'Local End IP' is '192 . 168 . 1 . 254'. The 'Global Start IP' is '1 . 2 . 3 . 4' and the 'Global End IP' is 'N/A'. At the bottom, there are 'Apply' and 'Cancel' buttons.

22 After the configurations, the **Address Mapping** screen looks as shown. You still have one IP address (1.2.3.7) that can be assigned to another internal server when you expand your network.

Figure 55 Tutorial Example: NAT Address Mapping Done





















NAT

NAT Overview **Address Mapping** Port Forwarding Port Triggering

SUA Address Mapping Rules

#	Local Start IP	Local End IP	Global Start IP	Global End IP	Type
1	0.0.0.0	255.255.255.255	0.0.0.0	N/A	M-1
2	N/A	N/A	0.0.0.0	N/A	Server

Full Feature Address Mapping Rules

#	Local Start IP	Local End IP	Global Start IP	Global End IP	Type	Modify
1	192.168.1.12	N/A	1.2.3.5	N/A	1-1	 
2	192.168.1.13	N/A	1.2.3.6	N/A	1-1	 
3	192.168.1.1	192.168.1.254	1.2.3.4	N/A	M-1	 
4	-	 
5	-	 
6	-	 
7	-	 
8	-	 
9	-	 
10	-	 

Insert new rule before rule (rule number)

Note: To allow traffic from the WAN to be forwarded through the ZyXEL Device, you must also create a firewall rule. Refer to [Section 4.2.5 on page 103](#) for more information.

4.2.4 Forwarding Traffic from the WAN to a Local Computer

A server NAT address mapping rule allows computers behind the NAT be accessible to the outside world. To have the ZyWALL forward incoming traffic to a specific computer on your local network, you should also create a port forwarding (server mapping) rule.

In this example, you want to forward FTP traffic using port 21 to the computer with the IP address of 192.168.1.39.

Figure 56 Tutorial Example: Forwarding Incoming FTP Traffic to a Local Computer

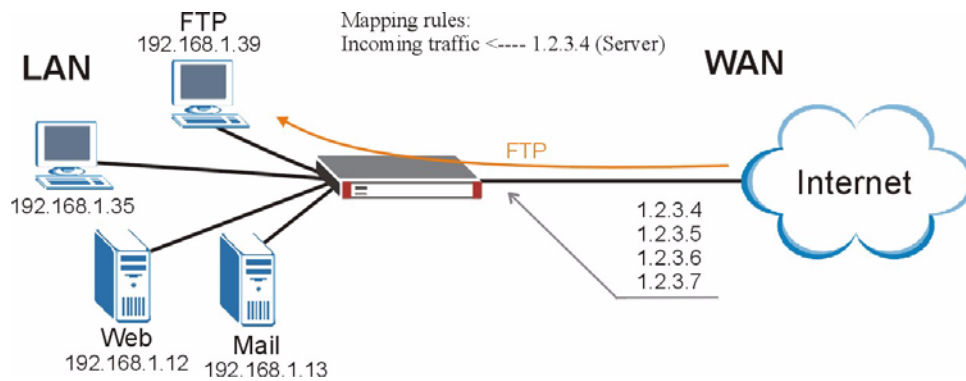

23 Click the forth rule's **Edit** icon (🔧) to configure a server rule.

Figure 57 Tutorial Example: NAT Address Mapping Edit: Server

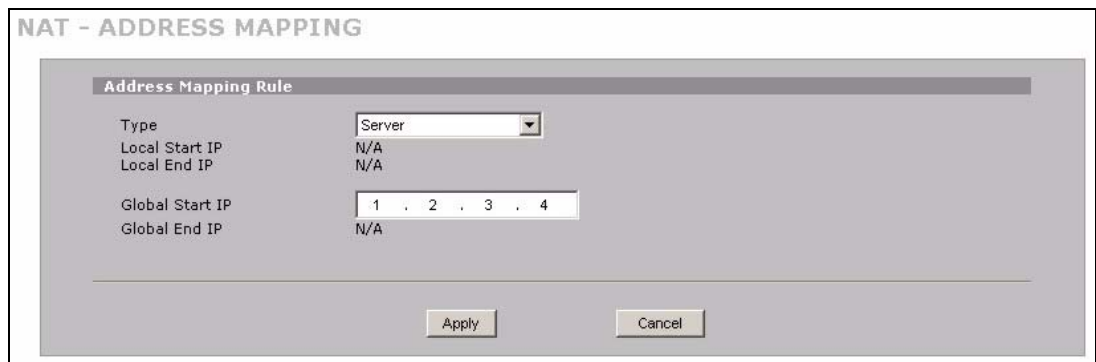

24 Port Forwarding tab.

25 Select the **Active** check box, enter a descriptive name (**FTP** for example), incoming port number (21) and 192.168.1.39 as the server IP address. Click **Apply**.

Figure 58 Tutorial Example: NAT Port Forwarding

NAT

NAT Overview Address Mapping Port Forwarding Port Triggering

Port Forwarding Rules

Default Server: 0 . 0 . 0 . 0 Go To Page: 1

#	Active	Name	Incoming Port(s)	Port Translation	Server IP Address
1	<input checked="" type="checkbox"/>	FTP	21 - 21	0 - 0	192 . 168 . 1 . 39
2	<input type="checkbox"/>		0 - 0	0 - 0	0 . 0 . 0 . 0
3	<input type="checkbox"/>		0 - 0	0 - 0	0 . 0 . 0 . 0
4	<input type="checkbox"/>		0 - 0	0 - 0	0 . 0 . 0 . 0
5	<input type="checkbox"/>		0 - 0	0 - 0	0 . 0 . 0 . 0
6	<input type="checkbox"/>		0 - 0	0 - 0	0 . 0 . 0 . 0
7	<input type="checkbox"/>		0 - 0	0 - 0	0 . 0 . 0 . 0
8	<input type="checkbox"/>		0 - 0	0 - 0	0 . 0 . 0 . 0
9	<input type="checkbox"/>		0 - 0	0 - 0	0 . 0 . 0 . 0
10	<input type="checkbox"/>		0 - 0	0 - 0	0 . 0 . 0 . 0
11	<input type="checkbox"/>		0 - 0	0 - 0	0 . 0 . 0 . 0
12	<input type="checkbox"/>		0 - 0	0 - 0	0 . 0 . 0 . 0

Note 1: You may also need to create a [Firewall](#) rule.
Note 2: Port Translation is optional.

Apply Reset

4.2.5 Allow WAN-to-LAN Traffic through the Firewall

By default, the ZyWALL blocks any traffic initiated from the WAN to the LAN. To have the ZyWALL forward traffic initiated from the WAN to a local computer or server on the LAN, you need to configure a firewall rule to allow it.

In this example, you create the firewall rules to allow traffic from the WAN to the following servers on the LAN:

- Web server
- Mail server
- FTP server

Figure 59 Tutorial Example: Forwarding Incoming FTP Traffic to a Local Computer

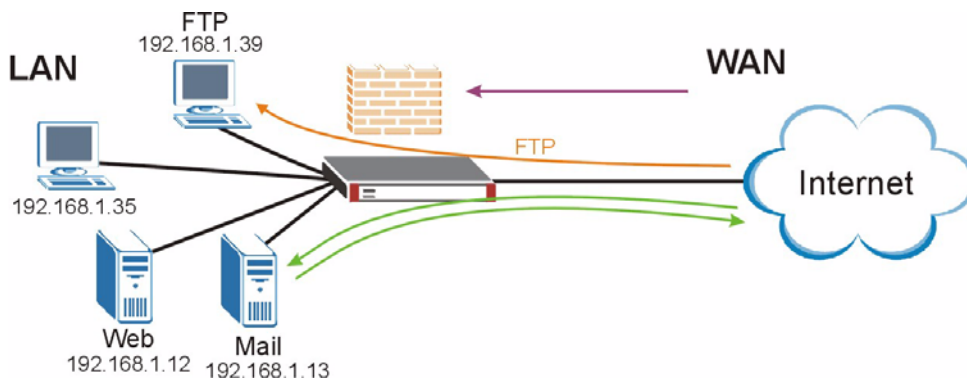

- 1 Click **SECURITY > FIREWALL**.
- 2 Make sure the firewall is enabled and traffic from the WAN to the LAN is dropped.

Figure 60 Tutorial Example: Firewall Default Rule

FIREWALL

Default Rule | Rule Summary | Anti-Probing | Threshold | Service

Default Rule Setup

Enable Firewall

Allow Asymmetrical Route (Warning: When this box is checked, all LAN to LAN, WAN to WAN, DMZ to DMZ, WLAN to WLAN, and VPN to VPN packets will bypass the Firewall check.)

From \ To	LAN	WAN	DMZ	WLAN	VPN
LAN	Permit <input type="checkbox"/>	Permit <input type="checkbox"/>	Permit <input checked="" type="checkbox"/>	Drop <input checked="" type="checkbox"/>	Permit <input type="checkbox"/>
WAN	Drop <input checked="" type="checkbox"/>	Drop <input checked="" type="checkbox"/>	Permit <input checked="" type="checkbox"/>	Permit <input type="checkbox"/>	Permit <input type="checkbox"/>
DMZ	Drop <input checked="" type="checkbox"/>	Permit <input checked="" type="checkbox"/>	Drop <input checked="" type="checkbox"/>	Drop <input checked="" type="checkbox"/>	Permit <input type="checkbox"/>
WLAN	Drop <input checked="" type="checkbox"/>	Permit <input type="checkbox"/>	Drop <input checked="" type="checkbox"/>	Drop <input checked="" type="checkbox"/>	Permit <input type="checkbox"/>
VPN	Permit <input type="checkbox"/>	Permit <input type="checkbox"/>	Permit <input type="checkbox"/>	Permit <input type="checkbox"/>	Permit <input type="checkbox"/>

* Log

Apply Reset

- 3 Go to the **Rule Summary** screen.
- 4 Select the **WAN to LAN** packet direction and click the **Insert** button to create a new firewall rule.

Figure 61 Tutorial Example: Firewall Rule: WAN to LAN

FIREWALL

Default Rule | Rule Summary | Anti-Probing | Threshold | Service

Rule Summary

Firewall Rules Storage Space in Use

0% 100%

Packet Direction: WAN to LAN

Default Policy: Drop, Log

#	Name	Active	Source Address	Destination Address	Service Type	Action	Sch.	Log	Modify
1	W2L_Rule_1	N	Any	Any	BOOTP_CLIENT(UDP:68)	Permit	No	No	
2	W2L_Rule_2	N	Any	Any	NetBIOS(TCP/UDP:137~139,445)	Permit	No	No	

Insert new rule before rule (rule number)

Move rule to rule (rule number)

- 5 Configure a firewall rule to allow traffic from the WAN to the web server.
Enter a descriptive name (W-L_Web for example).
Select **Any** in the **Destination Address(es)** box and click **Delete**.
Select **Single Address** as the destination address type. Enter 192.168.1.12 and click **Add**.

Figure 62 Tutorial Example: Firewall Rule: WAN to LAN Address Edit for Web Server

FIREWALL - EDIT RULE

Rule Name: W-L_Web

Edit Source Address

Address Editor

Address Type: Any Address

Start IP Address: 0 . 0 . 0 . 0

End IP Address: 0 . 0 . 0 . 0

Subnet Mask: 0 . 0 . 0 . 0

Source Address(es): Any

Edit Destination Address

Address Editor

Address Type: Single Address

Start IP Address: 192 . 168 . 1 . 12

End IP Address: 0 . 0 . 0 . 0

Subnet Mask: 0 . 0 . 0 . 0

Destination Address(es):

Edit Service

- 6** Select **Any(All)** in the **Available Services** box on the left, and click **>>** to add it to the **Selected Service(s)** box on the right. Click **Apply**.

Figure 63 Tutorial Example: Firewall Rule: WAN to LAN Service Edit for Web Server

Edit Service

Available Services (See [Service](#))

Any(TCP)
Any(UDP)
Any(ICMP)
AIMNEV_ICQ(TCP:5190)
AUTH(TCP:113)
BGP(TCP:179)
BOOTP_CLIENT(UDP:68)
BOOTP_SERVER(UDP:67)
CU-SEEME(TCP/UDP:7648,24032)
DNS(TCP/UDP:53)
FINGER(TCP:79)
FTP(TCP:20,21)
H.323(TCP:1720)
HTTP(TCP:80)
HTTPS(TCP:443)

Selected Service(s): Any(All)

Edit Schedule

Day to Apply:
 Sun Mon Tue Wed Thu Fri Sat

Time of Day to Apply: (24-Hour Format)
 All day

Start: 0 (Hour) 0 (Minute) End: 0 (Hour) 0 (Minute)

Actions When Matched

Log Packet Information When Matched
 Send Alert Message to Administrator When Matched

Action for Matched Packets: Permit

Apply Cancel

- 7 Click the **Insert** button to configure a firewall rule to allow traffic from the WAN to the mail server.

Enter a descriptive name (W-L_Mail for example).

Select **Any** in the **Destination Address(es)** box and click **Delete**.

Select **Single Address** as the destination address type. Enter 192.168.1.13 and click **Add**.

Figure 64 Tutorial Example: Firewall Rule: WAN to LAN Address Edit for Mail Server

FIREWALL - EDIT RULE

Rule Name: W-L_Mail

Edit Source Address

Address Editor

Address Type: Any Address

Start IP Address: 0 . 0 . 0 . 0

End IP Address: 0 . 0 . 0 . 0

Subnet Mask: 0 . 0 . 0 . 0

Source Address(es): Any

Edit Destination Address

Address Editor

Address Type: Single Address

Start IP Address: 192 . 168 . 1 . 13

End IP Address: 0 . 0 . 0 . 0

Subnet Mask: 0 . 0 . 0 . 0

Destination Address(es):

Edit Service

- 8 Select **Any(All)** in the **Available Services** box on the left, and click **>>** to add it to the **Selected Service(s)** box on the right. Click **Apply**.

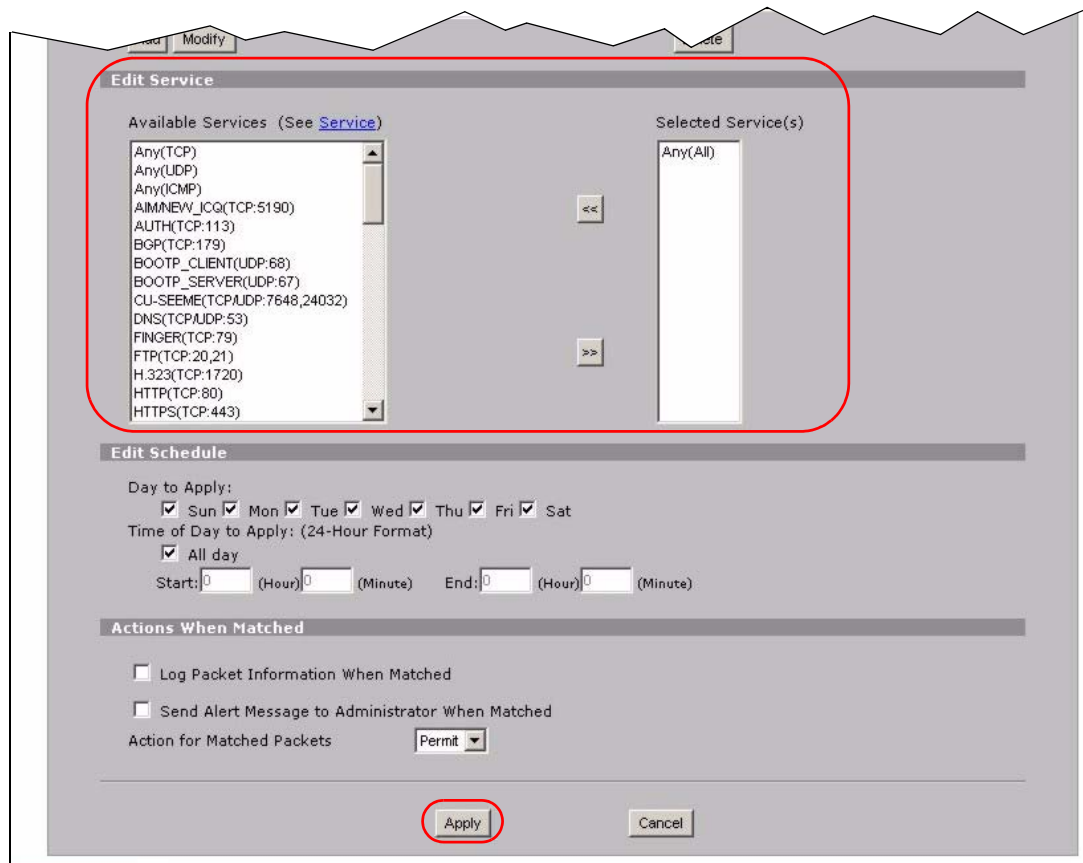
Figure 65 Tutorial Example: Firewall Rule: WAN to LAN Service Edit for Mail Server

- 9** Click the **Insert** button to configure a firewall rule to allow FTP traffic from the WAN to the FTP server.

Enter a descriptive name (W-L_FTP for example).

Select **Any** in the **Destination Address(es)** box and click **Delete**.

Select **Single Address** as the destination address type. Enter 192.168.1.39 and click **Add**.

Figure 66 Tutorial Example: Firewall Rule: WAN to LAN Address Edit for FTP Server

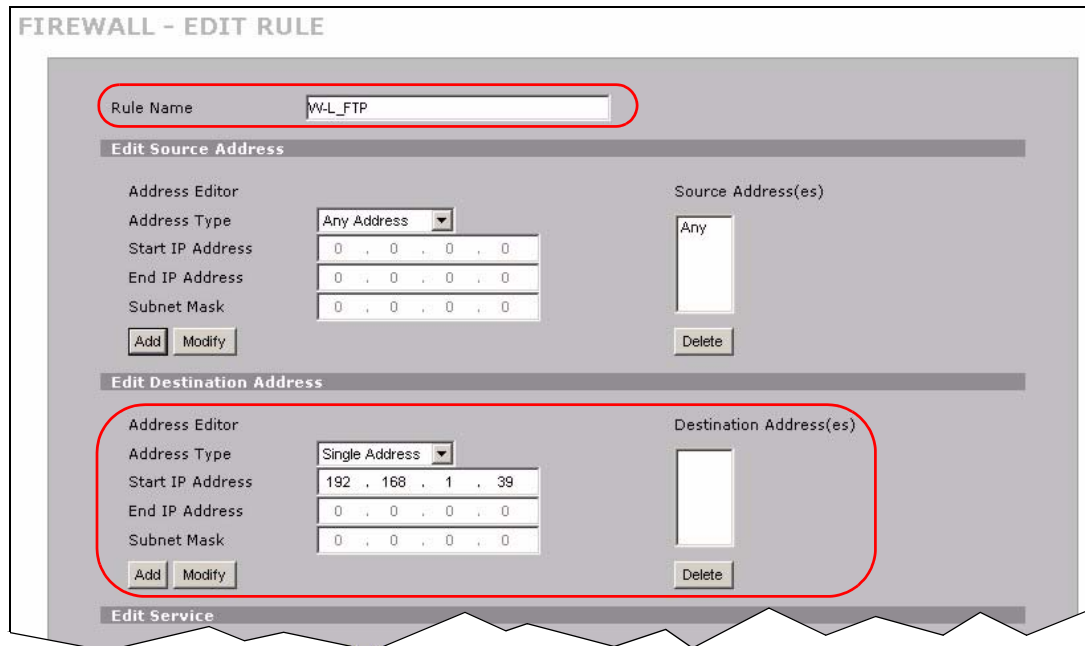

10 Select **FTP(TCP:20,21)** in the **Available Services** box on the left, and click **>>** to add it to the **Selected Service(s)** box on the right. Click **Apply**.

Figure 67 Tutorial Example: Firewall Rule: WAN to LAN Service Edit for FTP Server

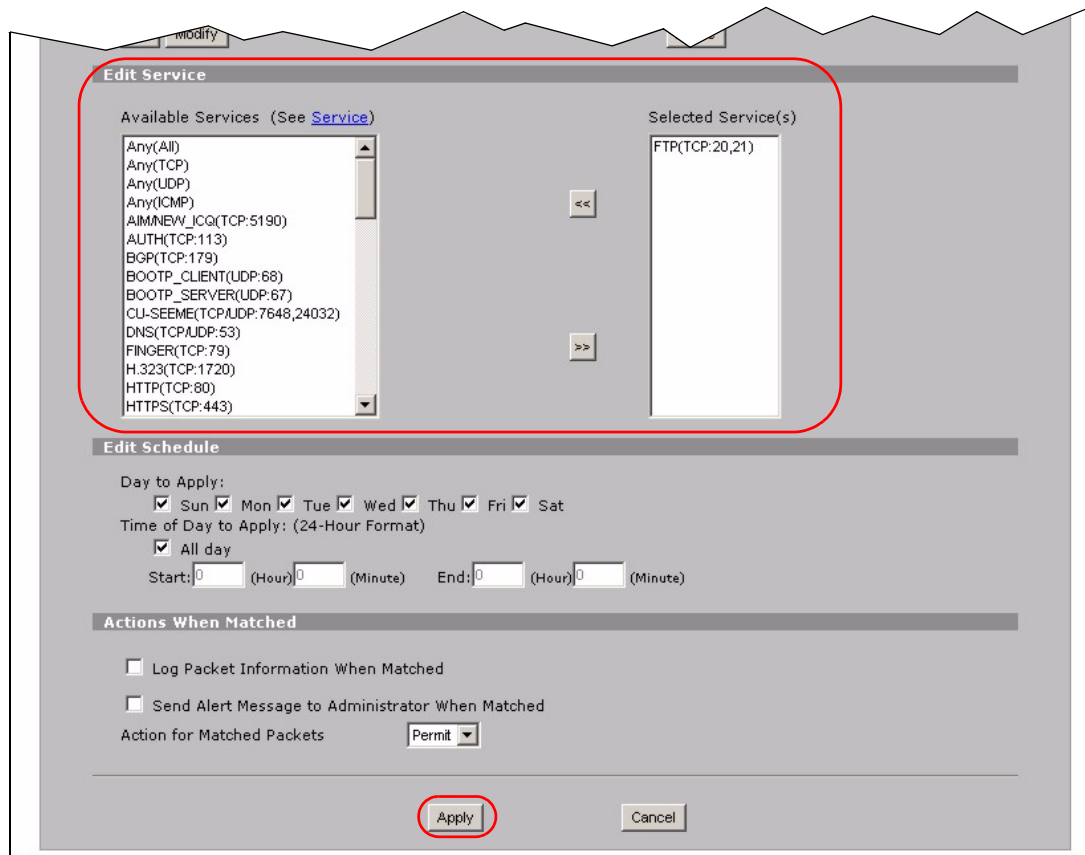

11 When you are done, the **Rule Summary** screen looks as shown.

Figure 68 Tutorial Example: Firewall Rule Summary

FIREWALL

Default Rule **Rule Summary** Anti-Probing Threshold Service

Rule Summary

Firewall Rules Storage Space in Use
0% 6% 100%

Packet Direction: WAN to LAN

Default Policy: Drop, Log

#	Name	Active	Source Address	Destination Address	Service Type	Action	Sch.	Log	Modify
1	W-L_FTP	Y	Any	192.168.1.39	FTP(TCP:20,21)	Permit	No	No	
2	W-L_Mail	Y	Any	192.168.1.13	Any(All)	Permit	No	No	
3	W-L_Web	Y	Any	192.168.1.12	Any(All)	Permit	No	No	
4	W2L_Rule_1	N	Any	Any	BOOTP_CLIENT(UDP:68)	Permit	No	No	
5	W2L_Rule_2	N	Any	Any	NetBIOS(TCP/UDP:137-139,445)	Permit	No	No	

Insert new rule before rule (rule number)

Move rule to rule (rule number)

4.2.6 Testing the Connections

- 1 Open the web browser on one of the local computers and enter any web site's URL in the address bar. If you can access the web site, your WAN connection and NAT address mapping are configured successfully. If you cannot access it, make sure you entered the correct information in the **WAN and NAT Address Mapping** screens. Also check that the Internet account is active and the computer's IP address is in the same subnet as the ZyWALL.
- 2 Open your web browser and try accessing the web server (1.2.3.5) from the outside network. If you cannot access the web server, make sure the NAT address mapping rule is configured correctly and there is a firewall rule to allow HTTP traffic from the WAN to the web server.
- 3 Try accessing the FTP server (1.2.3.4) from the outside network to send or retrieve a file. If you cannot access the FTP server, make sure the NAT port forwarding rule is active and there is a firewall rule to allow FTP traffic from the WAN to FTP server.

4.3 Using NAT with Multiple Game Players

If two users (behind the ZyWALL) want to connect to the same server to play online games at the same time, but the server does not allow more than one login from the same IP address, you can configure a many-to-many rule instead of a many-to-one rule.

In this example, you have four static IP addresses (1.2.3.4 to 1.2.3.7) from your ISP. After you set up your WAN connection (see [Section 4.2.2 on page 94](#)), use the **NAT > Address Mapping** screen to map the third and fourth public IP addresses to the mail server (192.168.1.12) and web server (192.168.1.13) respectively. The first and second public IP addresses are mapped to other outgoing LAN traffic. See [Section 4.2.3 on page 97](#) for more information about IP address mapping.

When you finish configuration, the screen looks as shown.

Figure 69 Tutorial Example: NAT Address Mapping Done: Game Playing

NAT

NAT Overview | **Address Mapping** | Port Forwarding | Port Triggering

SUA Address Mapping Rules

#	Local Start IP	Local End IP	Global Start IP	Global End IP	Type
1	0.0.0.0	255.255.255.255	0.0.0.0	N/A	M-1
2	N/A	N/A	0.0.0.0	N/A	Server

Full Feature Address Mapping Rules

#	Local Start IP	Local End IP	Global Start IP	Global End IP	Type	Modify
1	192.168.1.12	N/A	1.2.3.6	N/A	1-1	
2	192.168.1.13	N/A	1.2.3.7	N/A	1-1	
3	192.168.1.1	192.168.1.254	1.2.3.4	1.2.3.5	M-M Ov	
4	-	
5	-	
6	-	
7	-	
8	-	
9	-	
10	-	

Insert new rule before rule (rule number)

Note: To allow traffic from the WAN to be forwarded through the ZyXEL Device, you must also create a firewall rule. Refer to [Section 4.2.5 on page 103](#) for more information.

4.4 How to Manage the ZyWALL's Bandwidth

This section shows you examples of how to allocate bandwidth and apply priorities to traffic that flows out through the ZyWALL's WAN port.

4.4.1 Example Parameters and Scenario

The following figure shows the network you want to set up in this example. The WAN port has an upstream (outgoing) speed of 512 kbps. To prevent SIP-based VoIP (Voice over IP) traffic from getting delayed due to heavy WWW or FTP traffic, you reserve 128 Kbps of bandwidth for outgoing VoIP traffic (from LAN to WAN) and higher priority than FTP or WWW traffic.

Figure 70 Tutorial Example: Bandwidth Management

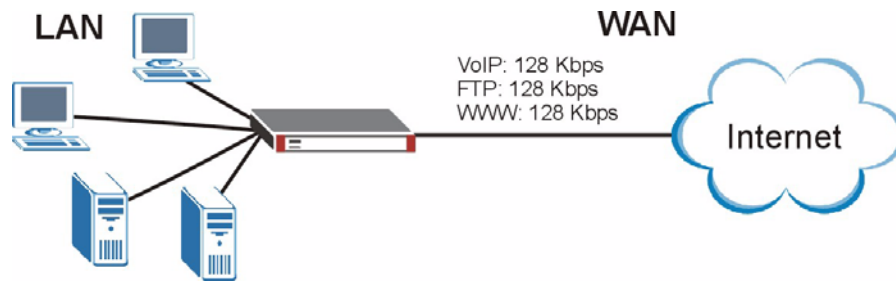

The following table shows the example information you configure in the bandwidth management screens.

Total Bandwidth Budget (WAN Upstream Speed)	512 Kbps
Bandwidth for VoIP Traffic	128 Kbps
Priority for VoIP Traffic	7
Bandwidth for FTP Traffic	128 Kbps
Priority for FTP Traffic	2
Bandwidth for WWW Traffic	128 Kbps
Priority for WWW Traffic	3

4.4.2 Configuring Bandwidth Management Rules

Follow the steps below to set up bandwidth management rules for different traffic.

- 4** Select **Active** to apply bandwidth management to traffic that is forwarded out through the WAN port.
- 5** Enter the WAN port's upstream speed.
- 6** Select **Priority-Based** to have the ZyWALL give preference to bandwidth classes with higher priorities.
- 7** Deselect the **Maximize Bandwidth Usage** option to reserve bandwidth for traffic that is not defined in a bandwidth class.
- 8** Click **Apply**.

Figure 71 Tutorial Example: Bandwidth Management Summary

BANDWIDTH MANAGEMENT

Summary Class Setup Monitor

Bandwidth Management Setup

Bandwidth Manager manages the bandwidth of traffic flowing out of router on the specific interface. Bandwidth Manager can be switched on/off independently for each interface.

Class	Active	Speed (kbps)	Scheduler	Maximize Bandwidth Usage
WAN	<input checked="" type="checkbox"/>	512	Priority-Based	<input type="checkbox"/>
LAN	<input type="checkbox"/>	100000	Fairness-Based	<input type="checkbox"/>
DMZ	<input type="checkbox"/>	100000	Fairness-Based	<input type="checkbox"/>
WLAN	<input type="checkbox"/>	100000	Fairness-Based	<input type="checkbox"/>

Apply Reset

9 Click the **Class Setup** tab.

10 Select the **WAN** interface and click the **Add Sub-Class** button to create a rule for VoIP traffic.

Figure 72 Tutorial Example: Bandwidth Management Class Setup

BANDWIDTH MANAGEMENT

Summary Class Setup Monitor

Class Setup

Interface: WAN

Bandwidth Management: Active

Root Class: 512 kbps

Add Sub-Class Edit Delete Statistics

Filter List

#	Filter Name	Service	Destination IP Address	Destination Port	Source IP Address	Source Port	Protocol ID
Move filter 0 to filter 0 (filter number).							

11 Enter a descriptive name (WAN_VoIP for example), the maximum bandwidth allowed and a priority for VoIP traffic. The higher the number, the higher the priority.

12 Enable this filter and select the SIP service.

13 Leave the IP address and subnet mask fields blank, so that the filter will be applied to any outgoing traffic through the WAN port. Click **Apply**.

Figure 73 Tutorial Example: Bandwidth Management Class Setup: VoIP

BANDWIDTH MANAGEMENT - EDIT CLASS

Class Configuration

Class Name: WAN_VoIP

Bandwidth Budget: 128 (Kbps)

Priority: 7 (0-7)

Borrow bandwidth from parent class

Filter Configuration

Enable Bandwidth Filter

Service: SIP

Destination IP Address: 0 . 0 . 0 . 0

Destination Subnet Mask: 0 . 0 . 0 . 0

Destination Port: 0

Source IP Address: 0 . 0 . 0 . 0

Source Subnet Mask: 0 . 0 . 0 . 0

Source Port: 0

Protocol ID: 0

Apply Cancel

14 Click the **Add Sub-Class** button to create a rule for FTP traffic as follows. Click **Apply**.

Figure 74 Tutorial Example: Bandwidth Management Class Setup: FTP

BANDWIDTH MANAGEMENT - EDIT CLASS

Class Configuration

Class Name: WAN_FTP

Bandwidth Budget: 128 (Kbps)

Priority: 2 (0-7)

Borrow bandwidth from parent class

Filter Configuration

Enable Bandwidth Filter

Service: FTP

Destination IP Address: 0 . 0 . 0 . 0

Destination Subnet Mask: 0 . 0 . 0 . 0

Destination Port: 0

Source IP Address: 0 . 0 . 0 . 0

Source Subnet Mask: 0 . 0 . 0 . 0

Source Port: 0

Protocol ID: 0

Apply Cancel

15 Click the **Add Sub-Class** button to create a rule for WWW traffic as follows. Click **Apply**.

Figure 75 Tutorial Example: Bandwidth Management Class Setup: WWW

BANDWIDTH MANAGEMENT - EDIT CLASS

Class Configuration

Class Name: WAN_WWW
 Bandwidth Budget: 128 (Kbps)
 Priority: 3 (0-7)
 Borrow bandwidth from parent class

Filter Configuration

Enable Bandwidth Filter

Service: Custom

Destination IP Address: 0 . 0 . 0 . 0
 Destination Subnet Mask: 0 . 0 . 0 . 0
 Destination Port: 80
 Source IP Address: 0 . 0 . 0 . 0
 Source Subnet Mask: 0 . 0 . 0 . 0
 Source Port: 80
 Protocol ID: 6

Apply Cancel

16When you are finished, the **Class Setup** screen looks as shown.

Figure 76 Tutorial Example: Bandwidth Management Class Setup Done

BANDWIDTH MANAGEMENT

Summary **Class Setup** Monitor

Class Setup

Interface: WAN
 Bandwidth Management: Active

Root Class: 512 kbps
 ----- WAN_FTP: 128 kbps
 ----- WAN_VoIP: 128 kbps
 ----- WAN_WWW: 128 kbps

Add Sub-Class Edit Delete Statistics

Filter List

#	Filter Name	Service	Destination IP Address	Destination Port	Source IP Address	Source Port	Protocol ID
1	WAN_VoIP	SIP	0.0.0.0/0	0	0.0.0.0/0	0	0
2	WAN_FTP	FTP	0.0.0.0/0	0	0.0.0.0/0	0	0
3	WAN_WWW	n/a	0.0.0.0/0	80	0.0.0.0/0	80	6

Move filter 0 to filter 0 (filter number).

17Use the **Monitor** screen to view the bandwidth usage and allotments for the WAN interface.

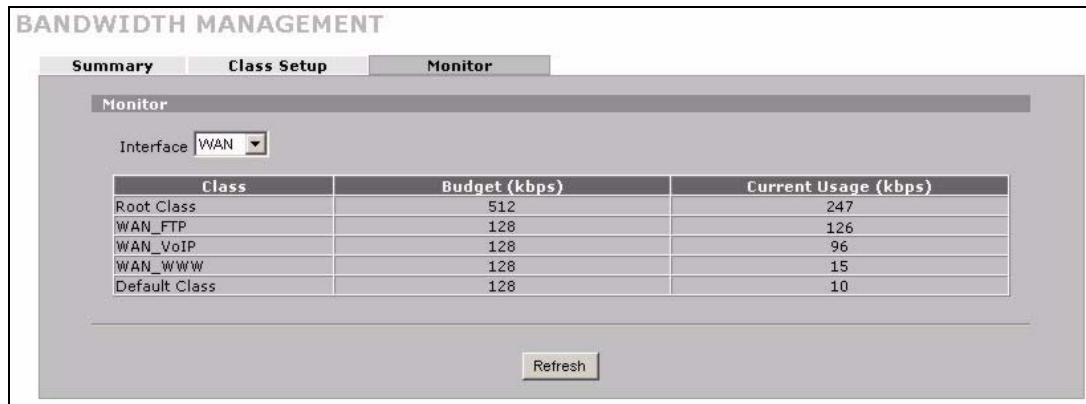
Figure 77 Tutorial Example: Bandwidth Management Monitor

Registration

5.1 myZyXEL.com overview

myZyXEL.com is ZyXEL's online services center where you can register your ZyWALL and manage subscription services available for the ZyWALL.



You need to create an account before you can register your device and activate the services at myZyXEL.com.

You can directly create a myZyXEL.com account, register your ZyWALL and activate a service using the **REGISTRATION** screen. Alternatively, go to <http://www.myZyXEL.com> with the ZyWALL's serial number and LAN MAC address to register it. Refer to the web site's on-line help for details.



To activate a service on a ZyWALL, you need to access myZyXEL.com via that ZyWALL.

5.1.1 Content Filtering Subscription Service

The ZyWALL can use the content filtering subscription service. Content filtering allows or blocks access to web sites. Subscribe to category-based content filtering to block access to categories of web sites based on content. Your ZyWALL accesses an external database that has millions of web sites categorized based on content. You can have the ZyWALL block, block and/or log access to web sites based on these categories. See the chapter about content filtering for more information.



To use a subscription service, you have to register and activate the corresponding service at myZyXEL.com (through the ZyWALL).

5.2 Registration

To register your ZyWALL with myZyXEL.com and activate the content filtering service, click **REGISTRATION** in the navigation panel to open the screen as shown next.

Figure 78 REGISTRATION

The screenshot shows the REGISTRATION screen with two tabs: 'Registration' and 'Service'. The 'Registration' tab is active. Under 'Device Registration', there are two radio buttons: 'New myZyXEL.com account' (selected) and 'Existing myZyXEL.com account'. Below are input fields for 'User Name' (containing 'ZyWALL'), 'Password' (masked with asterisks), 'Confirm Password' (masked with asterisks), 'E-Mail Address' (containing 'test@zyxel.com'), and 'Country' (a dropdown menu showing 'Taiwan'). A 'Check' button is next to the User Name field. A note says '(Type username and password from 6 to 20 characters.)'. Under 'Service Activation', there is a checked checkbox for 'Content Filtering 1-month Trial'. A note at the bottom says 'Note: For more device services management, please go to myZyXEL.com'. At the bottom of the form are 'Apply' and 'Reset' buttons.

The following table describes the labels in this screen.

Table 19 REGISTRATION

LABEL	DESCRIPTION
Device Registration	If you select Existing myZyXEL.com account , only the User Name and Password fields are available.
New myZyXEL.com account	If you haven't created an account at myZyXEL.com, select this option and configure the following fields to create an account and register your ZyWALL.
Existing myZyXEL.com account	If you already have an account at myZyXEL.com, select this option and enter your user name and password in the fields below to register your ZyWALL.
User Name	Enter a user name for your myZyXEL.com account. The name should be from six to 20 alphanumeric characters (and the underscore). Spaces are not allowed.
Check	Click this button to check with the myZyXEL.com database to verify the user name you entered has not been used.
Password	Enter a password of between six and 20 alphanumeric characters (and the underscore). Spaces are not allowed.
Confirm Password	Enter the password again for confirmation.
E-Mail Address	Enter your e-mail address. You can use up to 80 alphanumeric characters (periods and the underscore are also allowed) without spaces.
Country	Select your country from the drop-down box list.
Service Activation	You can try trial service subscription. After the trial expires, you can buy an iCard and enter the license key in the REGISTRATION > Service screen to extend the service.
Content Filtering 1-month Trial	Select the check box to activate a trial. The trial period starts the day you activate the trial.

Table 19 REGISTRATION

LABEL	DESCRIPTION
Apply	Click Apply to save your changes back to the ZyWALL.
Reset	Click Reset to begin configuring this screen afresh.



If the ZyWALL is registered already, this screen is read-only and indicates whether trial services are activated. Use the Service screen to update your service subscription status.

Figure 79 REGISTRATION: Registered Device

5.3 Service

After you activate a trial, you can also use the **Service** screen to register and enter your iCard's PIN number (license key). Click **REGISTRATION** > **Service** to open the screen as shown next.



If you restore the ZyWALL to the default configuration file or upload a different configuration file after you register, click the Service License Refresh button to update license information.

Figure 80 REGISTRATION > Service

REGISTRATION

Registration Service

Service Management

Service	Status	Registration Type	Expiration Day
Content Filter Service	Active	Trial	2005-08-24

License Upgrade

License Key:

(Sync with myZyXEL.com to download license Info.)

The following table describes the labels in this screen.

Table 20 REGISTRATION > Service

LABEL	DESCRIPTION
Service Management	
Service	This field displays the service name available on the ZyWALL.
Status	This field displays whether a service is activated (Active) or not (Inactive).
Registration Type	This field displays whether you applied for a trial application (Trial) or registered a service with your iCard's PIN number (Standard).
Expiration Day	This field displays the date your service expires.
License Upgrade	
License Key	Enter your iCard's PIN number and click Update to activate or extend a standard service subscription. If a standard service subscription runs out, you need to buy a new iCard (specific to your ZyWALL) and enter the new PIN number to extend the service.
Service License Refresh	Click this button to renew service license information (such as the license key, registration status and expiration day).

PART II

Network

LAN Screens (123)
Bridge Screens (135)
WAN Screens (141)
DMZ Screens (161)
Wireless LAN (171)

LAN Screens

This chapter describes how to configure LAN settings. This chapter is only applicable when the ZyWALL is in router mode.

6.1 LAN, WAN and the ZyWALL

A network is a shared communication system to which many computers are attached.

The Local Area Network (LAN) includes the computers and networking devices in your home or office that you connect to the ZyWALL's LAN ports.

The Wide Area Network (WAN) is another network (most likely the Internet) that you connect to the ZyWALL's WAN port. See [Chapter 8 on page 141](#) for how to use the WAN screens to set up your WAN connection.

The LAN and the WAN are two separate networks. The ZyWALL controls the traffic that goes between them. The following graphic gives an example.

Figure 81 LAN and WAN

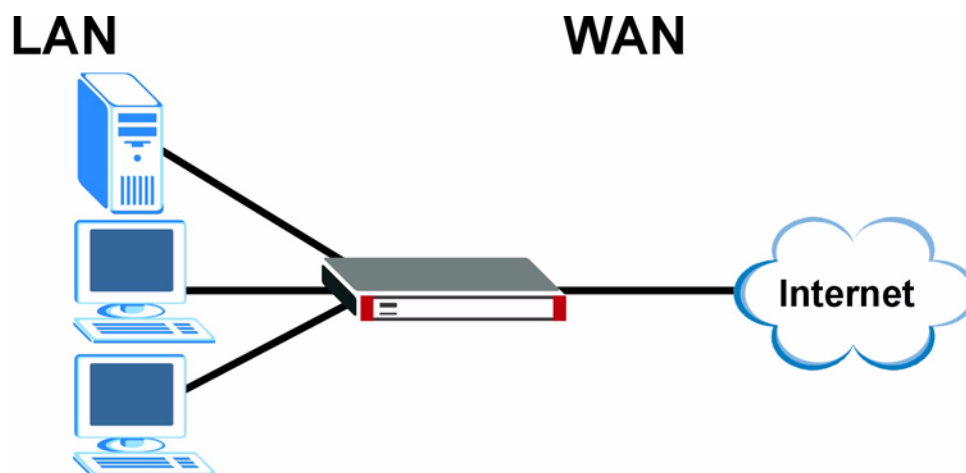

6.2 IP Address and Subnet Mask

Similar to the way houses on a street share a common street name, so too do computers on a LAN share one common network number.

Where you obtain your network number depends on your particular situation. If the ISP or your network administrator assigns you a block of registered IP addresses, follow their instructions in selecting the IP addresses and the subnet mask.

If the ISP did not explicitly give you an IP network number, then most likely you have a single user account and the ISP will assign you a dynamic IP address when the connection is established. If this is the case, it is recommended that you select a network number from 192.168.0.0 to 192.168.255.0 and you must enable the Network Address Translation (NAT) feature of the ZyWALL. The Internet Assigned Number Authority (IANA) reserved this block of addresses specifically for private use; please do not use any other number unless you are told otherwise. If you select 192.168.1.0 as the network number; it covers 254 individual addresses, from 192.168.1.1 to 192.168.1.254 (zero and 255 are reserved). In other words, the first three numbers specify the network number while the last number identifies an individual computer on that network.

Once you have decided on the network number, pick an IP address that is easy to remember, for instance, 192.168.1.1, for your ZyWALL, but make sure that no other device on your network is using that IP address.

The subnet mask specifies the network number portion of an IP address. Your ZyWALL will compute the subnet mask automatically based on the IP address that you entered. You don't need to change the subnet mask computed by the ZyWALL unless you are instructed to do otherwise.

6.2.1 Private IP Addresses

Every machine on the Internet must have a unique address. If your networks are isolated from the Internet, for example, only between your two branch offices, you can assign any IP addresses to the hosts without problems. However, the Internet Assigned Numbers Authority (IANA) has reserved the following three blocks of IP addresses specifically for private networks:

- 10.0.0.0 — 10.255.255.255
- 172.16.0.0 — 172.31.255.255
- 192.168.0.0 — 192.168.255.255

You can obtain your IP address from the IANA, from an ISP or it can be assigned from a private network. If you belong to a small organization and your Internet access is through an ISP, the ISP can provide you with the Internet addresses for your local networks. On the other hand, if you are part of a much larger organization, you should consult your network administrator for the appropriate IP addresses.



Regardless of your particular situation, do not create an arbitrary IP address; always follow the guidelines above. For more information on address assignment, please refer to RFC 1597, *Address Allocation for Private Internets* and RFC 1466, *Guidelines for Management of IP Address Space*.

6.3 DHCP

The ZyWALL can use DHCP (Dynamic Host Configuration Protocol, RFC 2131 and RFC 2132) to automatically assign IP addresses subnet masks, gateways, and some network information like the IP addresses of DNS servers to the computers on your LAN. You can alternatively have the ZyWALL relay DHCP information from another DHCP server. If you disable the ZyWALL's DHCP service, you must have another DHCP server on your LAN, or else the computers must be manually configured.

6.3.1 IP Pool Setup

The ZyWALL is pre-configured with a pool of IP addresses for the computers on your LAN. See [Appendix A on page 581](#) for the default IP pool range. Do not assign your LAN computers static IP addresses that are in the DHCP pool.

6.4 RIP Setup

RIP (Routing Information Protocol, RFC 1058 and RFC 1389) allows a router to exchange routing information with other routers. **RIP Direction** controls the sending and receiving of RIP packets. When set to **Both** or **Out Only**, the ZyWALL will broadcast its routing table periodically. When set to **Both** or **In Only**, it will incorporate the RIP information that it receives; when set to **None**, it will not send any RIP packets and will ignore any RIP packets received.

RIP Version controls the format and the broadcasting method of the RIP packets that the ZyWALL sends (it recognizes both formats when receiving). **RIP-1** is universally supported; but **RIP-2** carries more information. RIP-1 is probably adequate for most networks, unless you have an unusual network topology.

Both **RIP-2B** and **RIP-2M** send routing data in RIP-2 format; the difference being that **RIP-2B** uses subnet broadcasting while **RIP-2M** uses multicasting. Multicasting can reduce the load on non-router machines since they generally do not listen to the RIP multicast address and so will not receive the RIP packets. However, if one router uses multicasting, then all routers on your network must use multicasting, also.

By default, **RIP Direction** is set to **Both** and **RIP Version** to **RIP-1**.

6.5 Multicast

Traditionally, IP packets are transmitted in one of either two ways - Unicast (1 sender - 1 recipient) or Broadcast (1 sender - everybody on the network). Multicast delivers IP packets to a group of hosts on the network - not everybody and not just 1.

IGMP (Internet Group Multicast Protocol) is a network-layer protocol used to establish membership in a Multicast group - it is not used to carry user data. IGMP version 2 (RFC 2236) is an improvement over version 1 (RFC 1112) but IGMP version 1 is still in wide use. If you would like to read more detailed information about interoperability between IGMP version 2 and version 1, please see sections 4 and 5 of RFC 2236. The class D IP address is used to identify host groups and can be in the range 224.0.0.0 to 239.255.255.255. The address

224.0.0.0 is not assigned to any group and is used by IP multicast computers. The address 224.0.0.1 is used for query messages and is assigned to the permanent group of all IP hosts (including gateways). All hosts must join the 224.0.0.1 group in order to participate in IGMP. The address 224.0.0.2 is assigned to the multicast routers group.

The ZyWALL supports both IGMP version 1 (**IGMP-v1**) and IGMP version 2 (**IGMP-v2**). At start up, the ZyWALL queries all directly connected networks to gather group membership. After that, the ZyWALL periodically updates this information. IP multicasting can be enabled/disabled on the ZyWALL LAN and/or WAN interfaces in the web configurator (**LAN**; **WAN**). Select **None** to disable IP multicasting on these interfaces.

6.6 WINS

WINS (Windows Internet Naming Service) is a Windows implementation of NetBIOS Name Server (NBNS) on Windows. It keeps track of NetBIOS computer names. It stores a mapping table of your network's computer names and IP addresses. The table is dynamically updated for IP addresses assigned by DHCP. This helps reduce broadcast traffic since computers can query the server instead of broadcasting a request for a computer name's IP address. In this way WINS is similar to DNS, although WINS does not use a hierarchy (unlike DNS). A network can have more than one WINS server. Samba can also serve as a WINS server.

6.7 LAN

Click **NETWORK > LAN** to open the **LAN** screen. Use this screen to configure the ZyWALL's IP address and other LAN TCP/IP settings as well as the built-in DHCP server capability that assigns IP addresses and DNS servers to systems that support DHCP client capability.

Figure 82 NETWORK > LAN

The following table describes the labels in this screen.

Table 21 NETWORK > LAN

LABEL	DESCRIPTION
LAN TCP/IP	
IP Address	Type the IP address of your ZyWALL in dotted decimal notation. 192.168.1.1 is the factory default. Alternatively, click the right mouse button to copy and/or paste the IP address.
IP Subnet Mask	The subnet mask specifies the network number portion of an IP address. Your ZyWALL automatically calculates the subnet mask based on the IP address that you assign. Unless you are implementing subnetting, use the subnet mask computed by the ZyWALL.
RIP Direction	RIP (Routing Information Protocol, RFC1058 and RFC 1389) allows a router to exchange routing information with other routers. The RIP Direction field controls the sending and receiving of RIP packets. Select the RIP direction from Both/In Only/Out Only/None . When set to Both or Out Only , the ZyWALL will broadcast its routing table periodically. When set to Both or In Only , it will incorporate the RIP information that it receives; when set to None , it will not send any RIP packets and will ignore any RIP packets received. Both is the default.
RIP Version	The RIP Version field controls the format and the broadcasting method of the RIP packets that the ZyWALL sends (it recognizes both formats when receiving). RIP-1 is universally supported but RIP-2 carries more information. RIP-1 is probably adequate for most networks, unless you have an unusual network topology. Both RIP-2B and RIP-2M sends the routing data in RIP-2 format; the difference being that RIP-2B uses subnet broadcasting while RIP-2M uses multicasting. Multicasting can reduce the load on non-router machines since they generally do not listen to the RIP multicast address and so will not receive the RIP packets. However, if one router uses multicasting, then all routers on your network must use multicasting, also. By default, RIP direction is set to Both and the Version set to RIP-1 .

Table 21 NETWORK > LAN (continued)

LABEL	DESCRIPTION
Multicast	Select IGMP V-1 or IGMP V-2 or None . IGMP (Internet Group Multicast Protocol) is a network-layer protocol used to establish membership in a Multicast group - it is not used to carry user data. IGMP version 2 (RFC 2236) is an improvement over version 1 (RFC 1112) but IGMP version 1 is still in wide use. If you would like to read more detailed information about interoperability between IGMP version 2 and version 1, please see <i>sections 4 and 5 of RFC 2236</i> .
DHCP Setup	
DHCP	DHCP (Dynamic Host Configuration Protocol, RFC 2131 and RFC 2132) allows individual clients (workstations) to obtain TCP/IP configuration at startup from a server. Unless you are instructed by your ISP, leave this field set to Server . When configured as a server, the ZyWALL provides TCP/IP configuration for the clients. When set as a server, fill in the IP Pool Starting Address and Pool Size fields. Select Relay to have the ZyWALL forward DHCP requests to another DHCP server. When set to Relay , fill in the DHCP Server Address field. Select None to stop the ZyWALL from acting as a DHCP server. When you select None , you must have another DHCP server on your LAN, or else the computers must be manually configured.
IP Pool Starting Address	This field specifies the first of the contiguous addresses in the IP address pool.
Pool Size	This field specifies the size, or count of the IP address pool.
DHCP Server Address	Type the IP address of the DHCP server to which you want the ZyWALL to relay DHCP requests. Use dotted decimal notation. Alternatively, click the right mouse button to copy and/or paste the IP address.
DHCP WINS Server 1, 2	Type the IP address of the WINS (Windows Internet Naming Service) server that you want to send to the DHCP clients. The WINS server keeps a mapping table of the computer names on your network and the IP addresses that they are currently using.
Windows Networking (NetBIOS over TCP/IP)	NetBIOS (Network Basic Input/Output System) are TCP or UDP packets that enable a computer to connect to and communicate with a LAN. For some dial-up services such as PPPoE or PPTP, NetBIOS packets cause unwanted calls. However it may sometimes be necessary to allow NetBIOS packets to pass through to the WAN in order to find a computer on the WAN.
Allow between LAN and WAN	Select this check box to forward NetBIOS packets from the LAN to the WAN and from the WAN to the LAN. If your firewall is enabled with the default policy set to block WAN to LAN traffic, you also need to enable the default WAN to LAN firewall rule that forwards NetBIOS traffic. Clear this check box to block all NetBIOS packets going from the LAN to the WAN and from the WAN to the LAN.
Allow between LAN and DMZ	Select this check box to forward NetBIOS packets from the LAN to the DMZ and from the DMZ to the LAN. If your firewall is enabled with the default policy set to block DMZ to LAN traffic, you also need to enable the default DMZ to LAN firewall rule that forwards NetBIOS traffic. Clear this check box to block all NetBIOS packets going from the LAN to the DMZ and from the DMZ to the LAN.
Allow between LAN and WLAN	Select this check box to forward NetBIOS packets from the LAN to the WLAN and from the WLAN to the LAN. Clear this check box to block all NetBIOS packets going from the LAN to the WLAN and from the WLAN to the LAN.
Apply	Click Apply to save your changes back to the ZyWALL.
Reset	Click Reset to begin configuring this screen afresh.

6.8 LAN Static DHCP

This table allows you to assign IP addresses on the LAN to specific individual computers based on their MAC addresses.

Every Ethernet device has a unique MAC (Media Access Control) address. The MAC address is assigned at the factory and consists of six pairs of hexadecimal characters, for example, 00:A0:C5:00:00:02.

To change your ZyWALL's static DHCP settings, click **NETWORK > LAN > Static DHCP**. The screen appears as shown.

Figure 83 NETWORK > LAN > Static DHCP

LAN

LAN Static DHCP IP Alias Port Roles

Static DHCP Table

#	MAC Address	IP Address
1	<input type="text"/>	0 . 0 . 0 . 0
2	<input type="text"/>	0 . 0 . 0 . 0
3	<input type="text"/>	0 . 0 . 0 . 0
4	<input type="text"/>	0 . 0 . 0 . 0
5	<input type="text"/>	0 . 0 . 0 . 0
6	<input type="text"/>	0 . 0 . 0 . 0
7	<input type="text"/>	0 . 0 . 0 . 0
8	<input type="text"/>	0 . 0 . 0 . 0
9	<input type="text"/>	0 . 0 . 0 . 0
10	<input type="text"/>	0 . 0 . 0 . 0
11	<input type="text"/>	0 . 0 . 0 . 0
12	<input type="text"/>	0 . 0 . 0 . 0
13	<input type="text"/>	0 . 0 . 0 . 0
14	<input type="text"/>	0 . 0 . 0 . 0
15	<input type="text"/>	0 . 0 . 0 . 0
16	<input type="text"/>	0 . 0 . 0 . 0
17	<input type="text"/>	0 . 0 . 0 . 0
18	<input type="text"/>	0 . 0 . 0 . 0
19	<input type="text"/>	0 . 0 . 0 . 0
20	<input type="text"/>	0 . 0 . 0 . 0
21	<input type="text"/>	0 . 0 . 0 . 0
22	<input type="text"/>	0 . 0 . 0 . 0
23	<input type="text"/>	0 . 0 . 0 . 0
24	<input type="text"/>	0 . 0 . 0 . 0
25	<input type="text"/>	0 . 0 . 0 . 0
26	<input type="text"/>	0 . 0 . 0 . 0
27	<input type="text"/>	0 . 0 . 0 . 0
28	<input type="text"/>	0 . 0 . 0 . 0
29	<input type="text"/>	0 . 0 . 0 . 0
30	<input type="text"/>	0 . 0 . 0 . 0
31	<input type="text"/>	0 . 0 . 0 . 0
32	<input type="text"/>	0 . 0 . 0 . 0

Apply Reset

The following table describes the labels in this screen.

Table 22 NETWORK > LAN > Static DHCP

LABEL	DESCRIPTION
#	This is the index number of the Static IP table entry (row).
MAC Address	Type the MAC address of a computer on your LAN.
IP Address	Type the IP address that you want to assign to the computer on your LAN. Alternatively, click the right mouse button to copy and/or paste the IP address.
Apply	Click Apply to save your changes back to the ZyWALL.
Reset	Click Reset to begin configuring this screen afresh.

6.9 LAN IP Alias

IP alias allows you to partition a physical network into different logical networks over the same Ethernet interface.

The ZyWALL has a single LAN interface. Even though more than one of ports 1~4 may be in the LAN port role, they are all still part of a single physical Ethernet interface and all use the same IP address.

The ZyWALL supports three logical LAN interfaces via its single physical LAN Ethernet interface. The ZyWALL itself is the gateway for each of the logical LAN networks.

When you use IP alias, you can also configure firewall rules to control access between the LAN's logical networks (subnets).



Make sure that the subnets of the logical networks do not overlap.

The following figure shows a LAN divided into subnets A, B, and C.

Figure 84 Physical Network & Partitioned Logical Networks

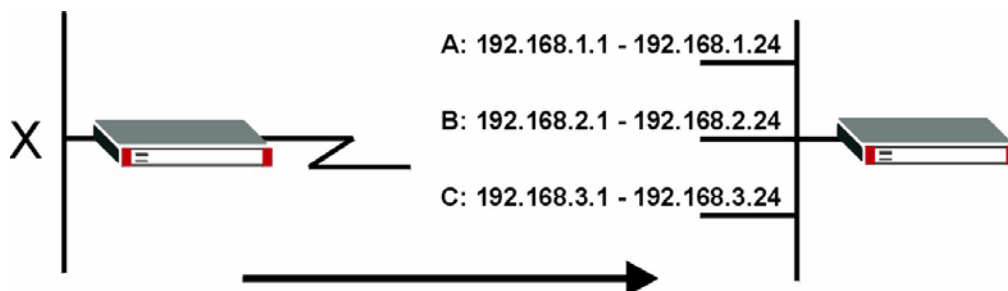

To change your ZyWALL's IP alias settings, click **NETWORK > LAN > IP Alias**. The screen appears as shown.

Figure 85 NETWORK > LAN > IP Alias

The screenshot shows the 'IP Alias' configuration page. It has tabs for 'LAN', 'Static DHCP', 'IP Alias', and 'Port Roles'. Under 'IP Alias 1', the 'Enable IP Alias 1' checkbox is checked. The IP Address is 192.168.2.1, the IP Subnet Mask is 255.255.255.0, RIP Direction is 'None', and RIP Version is 'RIP-1'. Under 'IP Alias 2', the 'Enable IP Alias 2' checkbox is checked. The IP Address is 192.168.3.1, the IP Subnet Mask is 255.255.255.0, RIP Direction is 'None', and RIP Version is 'RIP-1'. 'Apply' and 'Reset' buttons are at the bottom.

The following table describes the labels in this screen.

Table 23 NETWORK > LAN > IP Alias

LABEL	DESCRIPTION
Enable IP Alias 1, 2	Select the check box to configure another LAN network for the ZyWALL.
IP Address	Enter the IP address of your ZyWALL in dotted decimal notation. Alternatively, click the right mouse button to copy and/or paste the IP address.
IP Subnet Mask	Your ZyWALL will automatically calculate the subnet mask based on the IP address that you assign. Unless you are implementing subnetting, use the subnet mask computed by the ZyWALL.
RIP Direction	RIP (Routing Information Protocol, RFC 1058 and RFC 1389) allows a router to exchange routing information with other routers. The RIP Direction field controls the sending and receiving of RIP packets. Select the RIP direction from Both/In Only/Out Only/None . When set to Both or Out Only , the ZyWALL will broadcast its routing table periodically. When set to Both or In Only , it will incorporate the RIP information that it receives; when set to None , it will not send any RIP packets and will ignore any RIP packets received.
RIP Version	The RIP Version field controls the format and the broadcasting method of the RIP packets that the ZyWALL sends (it recognizes both formats when receiving). RIP-1 is universally supported but RIP-2 carries more information. RIP-1 is probably adequate for most networks, unless you have an unusual network topology. Both RIP-2B and RIP-2M sends the routing data in RIP-2 format; the difference being that RIP-2B uses subnet broadcasting while RIP-2M uses multicasting. Multicasting can reduce the load on non-router machines since they generally do not listen to the RIP multicast address and so will not receive the RIP packets. However, if one router uses multicasting, then all routers on your network must use multicasting, also. By default, RIP direction is set to Both and the Version set to RIP-1 .
Apply	Click Apply to save your changes back to the ZyWALL.
Reset	Click Reset to begin configuring this screen afresh.

6.10 LAN Port Roles

Use the **Port Roles** screen to set ports as part of the LAN, DMZ and/or WLAN interface. Ports 1~4 on the ZyWALL can be part of the LAN, DMZ or WLAN interface.



Do the following if you are configuring from a computer connected to a LAN, DMZ or WLAN port and changing the port's role:

- 1 A port's IP address varies as its role changes, make sure your computer's IP address is in the same subnet as the ZyWALL's LAN, DMZ or WLAN IP address.
- 2 Use the appropriate LAN, DMZ or WLAN IP address to access the ZyWALL.

To change your ZyWALL's port role settings, click **NETWORK > LAN > Port Roles**. The screen appears as shown.

The radio buttons correspond to Ethernet ports on the front panel of the ZyWALL. On the ZyWALL, ports 1 to 4 are all LAN ports by default.



Your changes are also reflected in the DMZ Port Roles and WLAN Port Roles screens.

Figure 86 NETWORK > LAN > Port Roles

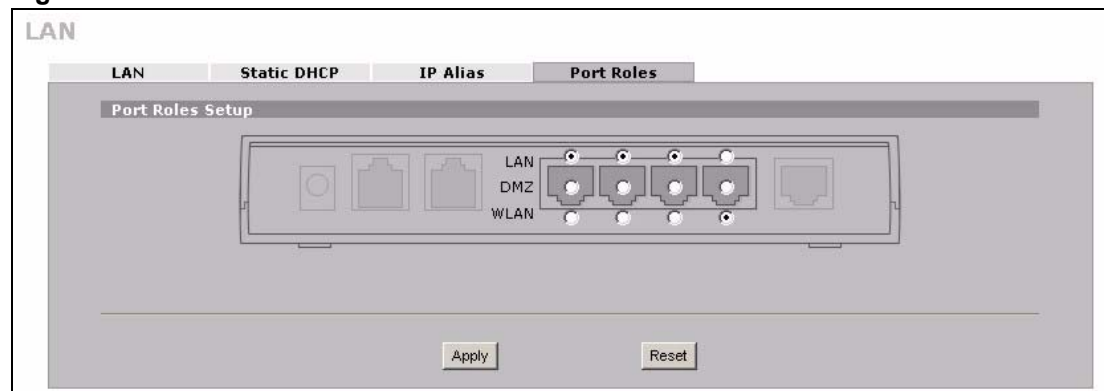

The following table describes the labels in this screen.

Table 24 NETWORK > LAN > Port Roles

LABEL	DESCRIPTION
LAN	Select a port's LAN radio button to use the port as part of the LAN. The port will use the ZyWALL's LAN IP address and MAC address.
DMZ	Select a port's DMZ radio button to use the port as part of the DMZ. The port will use the ZyWALL's DMZ IP address and MAC address.
WLAN	Select a port's WLAN radio button to use the port as part of the WLAN. The port will use the ZyWALL's WLAN IP address and MAC address.

Table 24 NETWORK > LAN > Port Roles (continued)

LABEL	DESCRIPTION
Apply	Click Apply to save your changes back to the ZyWALL.
Reset	Click Reset to begin configuring this screen afresh.

After you change the LAN/DMZ/WLAN port roles and click **Apply**, please wait for few seconds until the following screen appears. Click **Return** to go back to the **Port Roles** screen.

Figure 87 Port Roles Change Complete

Bridge Screens

This chapter describes how to configure bridge settings. This chapter is only applicable when the ZyWALL is in bridge mode.

7.1 Bridge Loop

The ZyWALL can act as a bridge between a switch and a wired LAN or between two routers.

Be careful to avoid bridge loops when you enable bridging in the ZyWALL. Bridge loops cause broadcast traffic to circle the network endlessly, resulting in possible throughput degradation and disruption of communications. The following example shows the network topology that can lead to this problem:

- If your ZyWALL (in bridge mode) is connected to a wired LAN while communicating with another bridge or a switch that is also connected to the same wired LAN as shown next.

Figure 88 Bridge Loop: Bridge Connected to Wired LAN

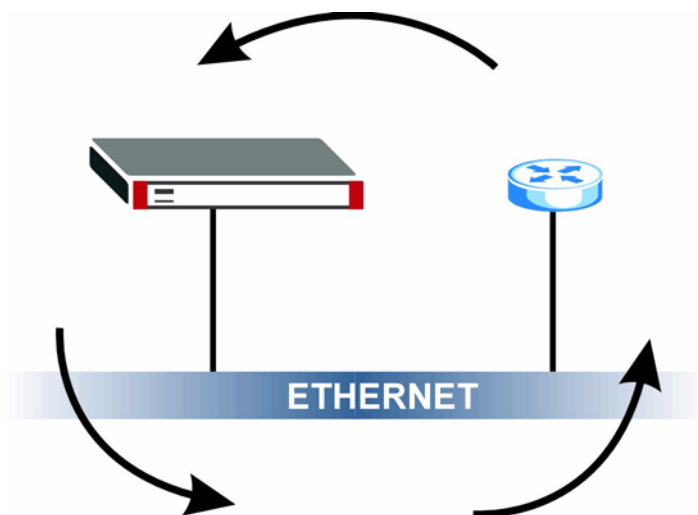

To prevent bridge loops, ensure that your ZyWALL is not set to bridge mode while connected to two wired segments of the same LAN or you enable RSTP in the **Bridge** screen.

7.2 Spanning Tree Protocol (STP)

STP detects and breaks network loops and provides backup links between switches, bridges or routers. It allows a bridge to interact with other STP-compliant bridges in your network to ensure that only one route exists between any two stations on the network.

7.2.1 Rapid STP

The ZyWALL uses IEEE 802.1w RSTP (Rapid Spanning Tree Protocol) that allow faster convergence of the spanning tree (while also being backwards compatible with STP-only aware bridges). Using RSTP, topology change information does not have to propagate to the root bridge and unwanted learned addresses are flushed from the filtering database. In RSTP, the port states are Discarding, Learning, and Forwarding.

7.2.2 STP Terminology

The root bridge is the base of the spanning tree.

Path cost is the cost of transmitting a frame from the root bridge to that port. It is assigned according to the speed of the link to which a port is attached. The slower the media, the higher the cost - see the next table.

Table 25 STP Path Costs

	LINK SPEED	RECOMMENDED VALUE	RECOMMENDED RANGE	ALLOWED RANGE
Path Cost	4Mbps	250	100 to 1000	1 to 65535
Path Cost	10Mbps	100	50 to 600	1 to 65535
Path Cost	16Mbps	62	40 to 400	1 to 65535
Path Cost	100Mbps	19	10 to 60	1 to 65535
Path Cost	1Gbps	4	3 to 10	1 to 65535
Path Cost	10Gbps	2	1 to 5	1 to 65535

On each bridge, the root port is the port through which this bridge communicates with the root. It is the port on this switch with the lowest path cost to the root (the root path cost). If there is no root port, then this bridge has been accepted as the root bridge of the spanning tree network.

For each LAN segment, a designated bridge is selected. This bridge has the lowest cost to the root among the bridges connected to the LAN.

7.2.3 How STP Works

After a bridge determines the lowest cost-spanning tree with STP, it enables the root port and the ports that are the designated ports for connected LANs, and disables all other ports that participate in STP. Network packets are therefore only forwarded between enabled ports, eliminating any possible network loops.

STP-aware bridges exchange Bridge Protocol Data Units (BPDUs) periodically. When the bridged LAN topology changes, a new spanning tree is constructed.

Once a stable network topology has been established, all bridges listen for Hello BPDUs (Bridge Protocol Data Units) transmitted from the root bridge. If a bridge does not get a Hello BPDU after a predefined interval (Max Age), the bridge assumes that the link to the root bridge is down. This bridge then initiates negotiations with other bridges to reconfigure the network to re-establish a valid network topology.

7.2.4 STP Port States

STP assigns five port states (see next table) to eliminate packet looping. A bridge port is not allowed to go directly from blocking state to forwarding state so as to eliminate transient loops.

Table 26 STP Port States

PORT STATE	DESCRIPTION
Disabled	STP is disabled (default).
Blocking	Only configuration and management BPDUs are received and processed.
Listening	All BPDUs are received and processed.
Learning	All BPDUs are received and processed. Information frames are submitted to the learning process but not forwarded.
Forwarding	All BPDUs are received and processed. All information frames are received and forwarded.

7.3 Bridge

Select **Bridge** and click **Apply** in the **MAINTENANCE Device Mode** screen to have the ZyWALL function as a bridge.

In bridge mode, the ZyWALL functions as a transparent firewall (also known as a bridge firewall). The ZyWALL bridges traffic traveling between the ZyWALL's interfaces and still filters and inspects packets. You do not need to change the configuration of your existing network.

You can use the firewall and VPN in bridge mode.

Click **NETWORK > BRIDGE** to display the screen shown next. Use this screen to configure bridge and RSTP (Rapid Spanning Tree Protocol) settings.



In bridge mode, if you need to let DHCP clients behind the ZyWALL use a DHCP server on the WAN, enable the default WAN to LAN firewall rule for the BOOTP_CLIENT service.

Figure 89 NETWORK > Bridge

BRIDGE

Bridge **Port Roles**

Bridge Setup

IP Address: 172 . 23 . 37 . 1

IP Subnet Mask: 255 . 255 . 255 . 0

Gateway IP Address: 172 . 23 . 37 . 254

First DNS Server: 0 . 0 . 0 . 0

Second DNS Server: 0 . 0 . 0 . 0

Third DNS Server: 0 . 0 . 0 . 0

Rapid Spanning Tree Protocol Setup

Enable Rapid Spanning Tree Protocol

Bridge Priority: 32768 0(Highest)~ 61440(Lowest)

Bridge Hello Time: 2 1(Second)~ 10(Seconds)

Bridge Max Age: 20 6(Seconds)~ 40(Seconds)

Forward Delay: 15 4(Seconds)~ 30(Seconds)

Bridge Port	RSTP Active	RSTP Priority 0(Highest)~240(Lowest)	RSTP Path Cost 1(Lowest)~65535 (Highest)
WAN	<input type="checkbox"/>	128	250
LAN	<input type="checkbox"/>	128	250
DMZ	<input type="checkbox"/>	128	250
WLAN Interface	<input type="checkbox"/>	128	250

Apply Reset

The following table describes the labels in this screen.

Table 27 NETWORK > Bridge

LABEL	DESCRIPTION
Bridge IP Address Setup	
IP Address	Type the IP address of your ZyWALL in dotted decimal notation. Use an IP address in the same subnet as the network to which you connect the ZyWALL. Make sure the IP address does not conflict with any other device on the network.
IP Subnet Mask	The subnet mask specifies the network number portion of an IP address.
Gateway IP Address	Enter the gateway IP address.
First/Second/Third DNS Server	DNS (Domain Name System) is for mapping a domain name to its corresponding IP address and vice versa. The DNS server is extremely important because without it, you must know the IP address of a machine before you can access it. The ZyWALL uses a system DNS server (in the order you specify here) to resolve domain names for content filtering, the time server, etc. If you have the IP address(es) of the DNS server(s), enter the DNS server's IP address(es) in the field(s) to the right.

Table 27 NETWORK > Bridge (continued)

LABEL	DESCRIPTION
Rapid Spanning Tree Protocol Setup	
Enable Rapid Spanning Tree Protocol	Select the check box to activate RSTP on the ZyWALL.
Bridge Priority	Enter a number between 0 and 61440 as bridge priority of the ZyWALL. Bridge priority is used in determining the root switch, root port and designated port. The switch with the highest priority (lowest numeric value) becomes the root. If multiple devices have the lowest priority, the device with the lowest MAC address becomes the root. The lower the numeric value you assign, the higher the priority for this bridge. Bridge Priority determines the root bridge, which in turn determines Hello Time, Max Age and Forward Delay.
Bridge Hello Time	Enter an interval (between 1 and 10) in seconds that the root bridge waits before sending a hello packet.
Bridge Max Age	Enter an interval (between 6 and 40) in seconds that a bridge waits to get a Hello BPDU from the root bridge.
Forward Delay	Enter the length of time (between 4 and 30) in seconds that a bridge remains in the listening and learning port states. The default is 15 seconds.
Bridge Port	This is the bridge port type.
RSTP Active	Select the check box to enable RSTP on the corresponding port.
RSTP Priority 0(Highest)~240(Lowest)	Enter a number between 0 and 240 as RSTP priority for the corresponding port. 0 is the highest.
RSTP Path Cost 1(Lowest)~65535(Highest)	Enter a number between 1 and 65535 as RSTP path cost for the corresponding port. 65535 is the highest.
Apply	Click Apply to save your changes back to the ZyWALL.
Reset	Click Reset to begin configuring this screen afresh.

7.4 Bridge Port Roles

Use the **Port Roles** screen to set ports as part of the LAN, DMZ and/or WLAN interface.

Ports 1~4 on the ZyWALL can be part of the LAN, DMZ or WLAN interface.

To change your ZyWALL's port role settings, click **NETWORK > BRIDGE > Port Roles**. The screen appears as shown.

The radio buttons correspond to Ethernet ports on the front panel of the ZyWALL. On the ZyWALL, ports 1 to 4 are all LAN ports by default.

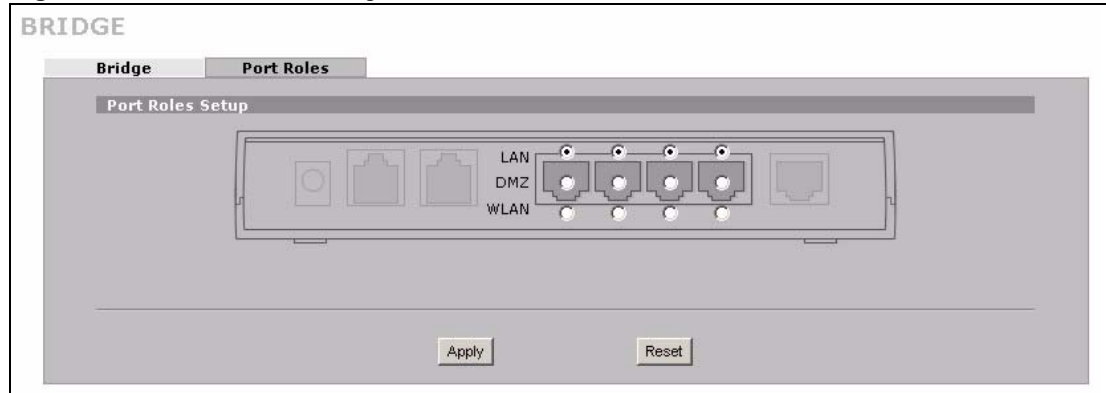
Figure 90 NETWORK > Bridge > Port Roles

The following table describes the labels in this screen.

Table 28 NETWORK > Bridge > Port Roles

LABEL	DESCRIPTION
LAN	Select a port's LAN radio button to use the port as part of the LAN.
DMZ	Select a port's DMZ radio button to use the port as part of the DMZ.
WLAN	Select a port's WLAN radio button to use the port as part of the WLAN.
Apply	Click Apply to save your changes back to the ZyWALL.
Reset	Click Reset to begin configuring this screen afresh.

After you change the LAN/DMZ/WLAN port roles and click **Apply**, please wait for few seconds until the following screen appears. Click **Return** to go back to the **Port Roles** screen.

Figure 91 Port Roles Change Complete

WAN Screens

This chapter describes how to configure WAN settings.

8.1 WAN Overview

- Use the **Route** screen to configure route priority for the ZyWALL.
- Use the **WAN** screen to configure the WAN port for Internet access on the ZyWALL.
- Use the **Traffic Redirect** screen to configure your traffic redirect properties and parameters.
- Use the **Dial Backup** screen to configure the backup WAN dial-up connection.

8.2 TCP/IP Priority (Metric)

The metric represents the "cost of transmission". A router determines the best route for transmission by choosing a path with the lowest "cost". RIP routing uses hop count as the measurement of cost, with a minimum of "1" for directly connected networks. The number must be between "1" and "15"; a number greater than "15" means the link is down. The smaller the number, the lower the "cost".

- 1 The metric sets the priority for the ZyWALL's routes to the Internet. Each route must have a unique metric.
- 2 The priorities of the WAN port routes must always be higher than the dial-backup and traffic redirect route priorities.

If the WAN port route has a metric of "1" and the traffic-redirect route has a metric of "2" and dial-backup route has a metric of "3", then the WAN port route acts as the primary default route. If the WAN port route fails to connect to the Internet, the ZyWALL tries the traffic-redirect route next. In the same manner, the ZyWALL uses the dial-backup route if the traffic-redirect route also fails.

The dial-backup or traffic redirect routes cannot take priority over the WAN routes.

8.3 WAN Route

Click **NETWORK > WAN** to open the **Route** screen. Use this screen to configure the priorities of the ZyWALL's routes and settings for Windows Networking traffic.

Figure 92 NETWORK > WAN Route

The following table describes the labels in this screen.

Table 29 NETWORK > WAN Route

LABEL	DESCRIPTION
Route Priority	
WAN Traffic Redirect Dial Backup	<p>The default WAN connection is "1" as your broadband connection via the WAN port should always be your preferred method of accessing the WAN. The default priority of the routes is WAN, Traffic Redirect and then Dial Backup:</p> <p>You have two choices for an auxiliary connection (Traffic Redirect and Dial Backup) in the event that your regular WAN connection goes down. If Dial Backup is preferred to Traffic Redirect, then type "14" in the Dial Backup Priority (metric) field (and leave the Traffic Redirect Priority (metric) at the default of "15").</p> <p>The Dial Backup field is available only when you enable the corresponding dial backup feature in the Dial Backup screen.</p>
Windows Networking (NetBIOS over TCP/IP):	<p>NetBIOS (Network Basic Input/Output System) are TCP or UDP packets that enable a computer to connect to and communicate with a LAN. For some dial-up services such as PPPoE or PPTP, NetBIOS packets cause unwanted calls.</p>
Allow between WAN and LAN	<p>Select this check box to forward NetBIOS packets from the LAN to the WAN and from the WAN to the LAN. If your firewall is enabled with the default policy set to block WAN to LAN traffic, you also need to enable the default WAN to LAN firewall rule that forwards NetBIOS traffic.</p> <p>Clear this check box to block all NetBIOS packets going from the LAN to the WAN and from the WAN to the LAN.</p>
Allow between WAN and DMZ	<p>Select this check box to forward NetBIOS packets from the WAN to the DMZ and from the DMZ to the WAN.</p> <p>Clear this check box to block all NetBIOS packets going from the WAN to the DMZ and from the DMZ to the WAN.</p>
Allow between WAN and WLAN	<p>Select this check box to forward NetBIOS packets from the WLAN to the WAN and from the WAN to the WLAN.</p> <p>Clear this check box to block all NetBIOS packets going from the WLAN to the WAN and from the WAN to the WLAN.</p>

Table 29 NETWORK > WAN Route (continued)

LABEL	DESCRIPTION
Allow Trigger Dial	Select this option to allow NetBIOS packets to initiate calls.
Apply	Click Apply to save your changes back to the ZyWALL.
Reset	Click Reset to begin configuring this screen afresh.

8.4 WAN IP Address Assignment

Every computer on the Internet must have a unique IP address. If your networks are isolated from the Internet, for instance, only between your two branch offices, you can assign any IP addresses to the hosts without problems. However, the Internet Assigned Numbers Authority (IANA) has reserved the following three blocks of IP addresses specifically for private networks.

Table 30 Private IP Address Ranges

10.0.0.0	-	10.255.255.255
172.16.0.0	-	172.31.255.255
192.168.0.0	-	192.168.255.255

You can obtain your IP address from the IANA, from an ISP or have it assigned by a private network. If you belong to a small organization and your Internet access is through an ISP, the ISP can provide you with the Internet addresses for your local networks. On the other hand, if you are part of a much larger organization, you should consult your network administrator for the appropriate IP addresses.



Regardless of your particular situation, do not create an arbitrary IP address; always follow the guidelines above. For more information on address assignment, please refer to RFC 1597, Address Allocation for Private Internets and RFC 1466, Guidelines for Management of IP Address Space.

8.5 DNS Server Address Assignment

Use DNS (Domain Name System) to map a domain name to its corresponding IP address and vice versa, for instance, the IP address of www.zyxel.com is 204.217.0.2. The DNS server is extremely important because without it, you must know the IP address of a computer before you can access it.

The ZyWALL can get the DNS server addresses in the following ways.

- 1 The ISP tells you the DNS server addresses, usually in the form of an information sheet, when you sign up. If your ISP gives you DNS server addresses, manually enter them in the DNS server fields.
- 2 If your ISP dynamically assigns the DNS server IP addresses (along with the ZyWALL's WAN IP address), set the DNS server fields to get the DNS server address from the ISP.

- 3 You can manually enter the IP addresses of other DNS servers. These servers can be public or private. A DNS server could even be behind a remote IPSec router (see [Section 20.5.1 on page 340](#)).

8.6 WAN MAC Address

Every Ethernet device has a unique MAC (Media Access Control) address. The MAC address is assigned at the factory and consists of six pairs of hexadecimal characters, for example, 00:A0:C5:00:00:02.

You can configure the WAN port's MAC address by either using the factory default or cloning the MAC address from a computer on your LAN. Once it is successfully configured, the address will be copied to the "rom" file (ZyNOS configuration file). It will not change unless you change the setting or upload a different "rom" file.

Table 31 Example of Network Properties for LAN Servers with Fixed IP Addresses

Choose an IP address	192.168.1.2-192.168.1.32; 192.168.1.65-192.168.1.254.
Subnet mask	255.255.255.0
Gateway (or default route)	192.168.1.1(ZyWALL LAN IP)

8.7 WAN

To change your ZyWALL's WAN ISP, IP and MAC settings, click **NETWORK > WAN > WAN**. The screen differs by the encapsulation.

8.7.1 WAN Ethernet Encapsulation

For ISPs (such as Telstra) that send UDP heartbeat packets to verify that the customer is still online, please create a **WAN-to-WAN/ZyWALL** firewall rule for those packets. Contact your ISP to find the correct port number.

The screen shown next is for **Ethernet** encapsulation.

Figure 93 NETWORK > WAN > WAN (Ethernet Encapsulation)

The following table describes the labels in this screen.

Table 32 NETWORK > WAN > WAN (Ethernet Encapsulation)

LABEL	DESCRIPTION
ISP Parameters for Internet Access	
Encapsulation	You must choose the Ethernet option when the WAN port is used as a regular Ethernet.
Service Type	Choose from Standard , Telstra (RoadRunner Telstra authentication method), RR-Manager (Roadrunner Manager authentication method), RR-Toshiba (Roadrunner Toshiba authentication method) or Telia Login . The following fields do not appear with the Standard service type.
User Name	Type the user name given to you by your ISP.
Password	Type the password associated with the user name above.
Retype to Confirm	Type your password again to make sure that you have entered is correctly.
Login Server IP Address	Type the authentication server IP address here if your ISP gave you one. This field is not available for Telia Login.
Login Server (Telia Login only)	Type the domain name of the Telia login server, for example login1.telia.com.

Table 32 NETWORK > WAN > WAN (Ethernet Encapsulation) (continued)

LABEL	DESCRIPTION
Relogin Every(min) (Telia Login only)	The Telia server logs the ZyWALL out if the ZyWALL does not log in periodically. Type the number of minutes from 1 to 59 (30 default) for the ZyWALL to wait between logins.
WAN IP Address Assignment	
Get automatically from ISP	Select this option If your ISP did not assign you a fixed IP address. This is the default selection.
Use Fixed IP Address	Select this option If the ISP assigned a fixed IP address.
My WAN IP Address	Enter your WAN IP address in this field if you selected Use Fixed IP Address .
My WAN IP Subnet Mask	Enter the IP subnet mask (if your ISP gave you one) in this field if you selected Use Fixed IP Address .
Gateway IP Address	Enter the gateway IP address (if your ISP gave you one) in this field if you selected Use Fixed IP Address .
Advanced Setup	
Enable NAT (Network Address Translation)	Network Address Translation (NAT) allows the translation of an Internet protocol address used within one network (for example a private IP address used in a local network) to a different IP address known within another network (for example a public IP address used on the Internet). Select this check box to enable NAT.
RIP Direction	RIP (Routing Information Protocol) allows a router to exchange routing information with other routers. The RIP Direction field controls the sending and receiving of RIP packets. Choose Both , None , In Only or Out Only . When set to Both or Out Only , the ZyWALL will broadcast its routing table periodically. When set to Both or In Only , the ZyWALL will incorporate RIP information that it receives. When set to None , the ZyWALL will not send any RIP packets and will ignore any RIP packets received. By default, RIP Direction is set to Both .
RIP Version	The RIP Version field controls the format and the broadcasting method of the RIP packets that the ZyWALL sends (it recognizes both formats when receiving). Choose RIP-1 , RIP-2B or RIP-2M . RIP-1 is universally supported; but RIP-2 carries more information. RIP-1 is probably adequate for most networks, unless you have an unusual network topology. Both RIP-2B and RIP-2M sends the routing data in RIP-2 format; the difference being that RIP-2B uses subnet broadcasting while RIP-2M uses multicasting. Multicasting can reduce the load on non-router machines since they generally do not listen to the RIP multicast address and so will not receive the RIP packets. However, if one router uses multicasting, then all routers on your network must use multicasting, also. By default, the RIP Version field is set to RIP-1 .
Enable Multicast	Select this check box to turn on IGMP (Internet Group Multicast Protocol). IGMP is a network-layer protocol used to establish membership in a Multicast group - it is not used to carry user data.

Table 32 NETWORK > WAN > WAN (Ethernet Encapsulation) (continued)

LABEL	DESCRIPTION
Multicast Version	Choose None (default), IGMP-V1 or IGMP-V2 . IGMP (Internet Group Multicast Protocol) is a session-layer protocol used to establish membership in a Multicast group – it is not used to carry user data. IGMP version 2 (RFC 2236) is an improvement over version 1 (RFC 1112) but IGMP version 1 is still in wide use. If you would like to read more detailed information about interoperability between IGMP version 2 and version 1, please see sections 4 and 5 of RFC 2236.
Spoof WAN MAC Address	You can use the factory assigned default MAC Address or cloning the MAC address from a computer on your LAN. Otherwise, select the check box next to Spoof WAN MAC Address and enter the IP address of the computer on the LAN whose MAC you are cloning. Once it is successfully configured, the address will be copied to the rom file (ZyNOS configuration file). It will not change unless you change the setting or upload a different ROM file.
Clone the computer's MAC address – IP Address	Enter the IP address of the computer on the LAN whose MAC you are cloning. It is recommended that you clone the MAC address prior to hooking up the WAN port.
Apply	Click Apply to save your changes back to the ZyWALL.
Reset	Click Reset to begin configuring this screen afresh.

8.7.2 PPPoE Encapsulation

The ZyWALL supports PPPoE (Point-to-Point Protocol over Ethernet). PPPoE is an IETF standard (RFC 2516) specifying how a personal computer (PC) interacts with a broadband modem (DSL, cable, wireless, etc.) connection. The **PPPoE** option is for a dial-up connection using PPPoE.

For the service provider, PPPoE offers an access and authentication method that works with existing access control systems (for example RADIUS).

One of the benefits of PPPoE is the ability to let you access one of multiple network services, a function known as dynamic service selection. This enables the service provider to easily create and offer new IP services for individuals.

Operationally, PPPoE saves significant effort for both you and the ISP or carrier, as it requires no specific configuration of the broadband modem at the customer site.

By implementing PPPoE directly on the ZyWALL (rather than individual computers), the computers on the LAN do not need PPPoE software installed, since the ZyWALL does that part of the task. Furthermore, with NAT, all of the LANs' computers will have access.

The screen shown next is for **PPPoE** encapsulation.

Figure 94 NETWORK > WAN > WAN (PPPoE Encapsulation)

WAN

Route **WAN** Traffic Redirect Dial Backup

ISP Parameters for Internet Access

Encapsulation: PPP over Ethernet

Service Name: (Optional)

User Name:

Password: *****

Retype to Confirm: *****

Authentication Type: CHAP/PAP

Nailed-Up

Idle Timeout: 100 (Seconds)

WAN IP Address Assignment

Get Automatically from ISP

Use Fixed IP Address

My WAN IP Address: 0 . 0 . 0 . 0

Advanced Setup

Enable NAT (Network Address Translation)

RIP Direction: None

RIP Version: RIP-1

Enable Multicast

Multicast Version: IGMP-v1

Spoof WAN MAC Address from LAN

Clone the computer's MAC address - IP Address: 192 . 168 . 1 . 33

Apply Reset

The following table describes the labels in this screen.

Table 33 NETWORK > WAN > WAN (PPPoE Encapsulation)

LABEL	DESCRIPTION
ISP Parameters for Internet Access	
Encapsulation	The PPPoE choice is for a dial-up connection using PPPoE. The router supports PPPoE (Point-to-Point Protocol over Ethernet). PPPoE is an IETF standard (RFC 2516) specifying how a personal computer (PC) interacts with a broadband modem (i.e. DSL, cable, wireless, etc.) connection. Operationally, PPPoE saves significant effort for both the end user and ISP/carrier, as it requires no specific configuration of the broadband modem at the customer site. By implementing PPPoE directly on the router rather than individual computers, the computers on the LAN do not need PPPoE software installed, since the router does that part of the task. Further, with NAT, all of the LAN's computers will have access.
Service Name	Type the PPPoE service name provided to you. PPPoE uses a service name to identify and reach the PPPoE server. This field is optional.
User Name	Type the user name given to you by your ISP.
Password	Type the password associated with the user name above.
Retype to Confirm	Type your password again to make sure that you have entered is correctly.

Table 33 NETWORK > WAN > WAN (PPPoE Encapsulation) (continued)

LABEL	DESCRIPTION
Authentication Type	Use the drop-down list box to select an authentication protocol for outgoing calls. Options are: CHAP/PAP - Your ZyWALL accepts either CHAP or PAP when requested by this remote node. CHAP - Your ZyWALL accepts CHAP only. PAP - Your ZyWALL accepts PAP only.
Nailed-Up	Select Nailed-Up if you do not want the connection to time out.
Idle Timeout	This value specifies the time in seconds that elapses before the ZyWALL automatically disconnects from the PPPoE server.
WAN IP Address Assignment	
Get automatically from ISP	Select this option If your ISP did not assign you a fixed IP address. This is the default selection.
Use Fixed IP Address	Select this option If the ISP assigned a fixed IP address.
My WAN IP Address	Enter your WAN IP address in this field if you selected Use Fixed IP Address .
Advanced Setup	
Enable NAT (Network Address Translation)	Network Address Translation (NAT) allows the translation of an Internet protocol address used within one network (for example a private IP address used in a local network) to a different IP address known within another network (for example a public IP address used on the Internet). Select this checkbox to enable NAT. For more information about NAT see Chapter 17 on page 307 .
RIP Direction	RIP (Routing Information Protocol) allows a router to exchange routing information with other routers. The RIP Direction field controls the sending and receiving of RIP packets. Choose Both , None , In Only or Out Only . When set to Both or Out Only , the ZyWALL will broadcast its routing table periodically. When set to Both or In Only , the ZyWALL will incorporate RIP information that it receives. When set to None , the ZyWALL will not send any RIP packets and will ignore any RIP packets received. By default, RIP Direction is set to Both .
RIP Version	The RIP Version field controls the format and the broadcasting method of the RIP packets that the ZyWALL sends (it recognizes both formats when receiving). Choose RIP-1 , RIP-2B or RIP-2M . RIP-1 is universally supported; but RIP-2 carries more information. RIP-1 is probably adequate for most networks, unless you have an unusual network topology. Both RIP-2B and RIP-2M sends the routing data in RIP-2 format; the difference being that RIP-2B uses subnet broadcasting while RIP-2M uses multicasting. Multicasting can reduce the load on non-router machines since they generally do not listen to the RIP multicast address and so will not receive the RIP packets. However, if one router uses multicasting, then all routers on your network must use multicasting, also. By default, the RIP Version field is set to RIP-1 .
Enable Multicast	Select this check box to turn on IGMP (Internet Group Multicast Protocol). IGMP is a network-layer protocol used to establish membership in a Multicast group - it is not used to carry user data.

Table 33 NETWORK > WAN > WAN (PPPoE Encapsulation) (continued)

LABEL	DESCRIPTION
Multicast Version	Choose None (default), IGMP-V1 or IGMP-V2 . IGMP (Internet Group Multicast Protocol) is a session-layer protocol used to establish membership in a Multicast group – it is not used to carry user data. IGMP version 2 (RFC 2236) is an improvement over version 1 (RFC 1112) but IGMP version 1 is still in wide use. If you would like to read more detailed information about interoperability between IGMP version 2 and version 1, please see sections 4 and 5 of RFC 2236.
Spoof WAN MAC Address	You can use the factory assigned default MAC Address or cloning the MAC address from a computer on your LAN. Otherwise, select the check box next to Spoof WAN MAC Address and enter the IP address of the computer on the LAN whose MAC you are cloning. Once it is successfully configured, the address will be copied to the rom file (ZyNOS configuration file). It will not change unless you change the setting or upload a different ROM file.
Clone the computer's MAC address – IP Address	Enter the IP address of the computer on the LAN whose MAC you are cloning. It is recommended that you clone the MAC address prior to hooking up the WAN port.
Apply	Click Apply to save your changes back to the ZyWALL.
Reset	Click Reset to begin configuring this screen afresh.

8.7.3 PPTP Encapsulation

Point-to-Point Tunneling Protocol (PPTP) is a network protocol that enables secure transfer of data from a remote client to a private server, creating a Virtual Private Network (VPN) using TCP/IP-based networks.

PPTP supports on-demand, multi-protocol and virtual private networking over public networks, such as the Internet. The screen shown next is for **PPTP** encapsulation.

Figure 95 NETWORK > WAN > WAN (PPTP Encapsulation)

The following table describes the labels in this screen.

Table 34 NETWORK > WAN > WAN (PPTP Encapsulation)

LABEL	DESCRIPTION
ISP Parameters for Internet Access	
Encapsulation	Point-to-Point Tunneling Protocol (PPTP) is a network protocol that enables secure transfer of data from a remote client to a private server, creating a Virtual Private Network (VPN) using TCP/IP-based networks. PPTP supports on-demand, multi-protocol, and virtual private networking over public networks, such as the Internet. The ZyWALL supports only one PPTP server connection at any given time. To configure a PPTP client, you must configure the User Name and Password fields for a PPP connection and the PPTP parameters for a PPTP connection.
User Name	Type the user name given to you by your ISP.
Password	Type the password associated with the user name above.
Retype to Confirm	Type your password again to make sure that you have entered is correctly.

Table 34 NETWORK > WAN > WAN (PPTP Encapsulation) (continued)

LABEL	DESCRIPTION
Authentication Type	Use the drop-down list box to select an authentication protocol for outgoing calls. Options are: CHAP/PAP - Your ZyWALL accepts either CHAP or PAP when requested by this remote node. CHAP - Your ZyWALL accepts CHAP only. PAP - Your ZyWALL accepts PAP only.
Nailed-up	Select Nailed-Up if you do not want the connection to time out.
Idle Timeout	This value specifies the time in seconds that elapses before the ZyWALL automatically disconnects from the PPTP server.
PPTP Configuration	
My IP Address	Type the (static) IP address assigned to you by your ISP.
My IP Subnet Mask	Your ZyWALL will automatically calculate the subnet mask based on the IP address that you assign. Unless you are implementing subnetting, use the subnet mask computed by the ZyWALL.
Server IP Address	Type the IP address of the PPTP server.
Connection ID/ Name	Type your identification name for the PPTP server.
WAN IP Address Assignment	
Get automatically from ISP	Select this option If your ISP did not assign you a fixed IP address. This is the default selection.
Use Fixed IP Address	Select this option If the ISP assigned a fixed IP address.
My WAN IP Address	Enter your WAN IP address in this field if you selected Use Fixed IP Address .
Advanced Setup	
Enable NAT (Network Address Translation)	Network Address Translation (NAT) allows the translation of an Internet protocol address used within one network (for example a private IP address used in a local network) to a different IP address known within another network (for example a public IP address used on the Internet). Select this checkbox to enable NAT. For more information about NAT see Chapter 17 on page 307 .
RIP Direction	RIP (Routing Information Protocol) allows a router to exchange routing information with other routers. The RIP Direction field controls the sending and receiving of RIP packets. Choose Both , None , In Only or Out Only . When set to Both or Out Only , the ZyWALL will broadcast its routing table periodically. When set to Both or In Only , the ZyWALL will incorporate RIP information that it receives. When set to None , the ZyWALL will not send any RIP packets and will ignore any RIP packets received. By default, RIP Direction is set to Both .

Table 34 NETWORK > WAN > WAN (PPTP Encapsulation) (continued)

LABEL	DESCRIPTION
RIP Version	<p>The RIP Version field controls the format and the broadcasting method of the RIP packets that the ZyWALL sends (it recognizes both formats when receiving).</p> <p>Choose RIP-1, RIP-2B or RIP-2M.</p> <p>RIP-1 is universally supported; but RIP-2 carries more information. RIP-1 is probably adequate for most networks, unless you have an unusual network topology. Both RIP-2B and RIP-2M sends the routing data in RIP-2 format; the difference being that RIP-2B uses subnet broadcasting while RIP-2M uses multicasting. Multicasting can reduce the load on non-router machines since they generally do not listen to the RIP multicast address and so will not receive the RIP packets. However, if one router uses multicasting, then all routers on your network must use multicasting, also. By default, the RIP Version field is set to RIP-1.</p>
Enable Multicast	<p>Select this check box to turn on IGMP (Internet Group Multicast Protocol). IGMP is a network-layer protocol used to establish membership in a Multicast group - it is not used to carry user data.</p>
Multicast Version	<p>Choose None (default), IGMP-V1 or IGMP-V2. IGMP (Internet Group Multicast Protocol) is a session-layer protocol used to establish membership in a Multicast group – it is not used to carry user data. IGMP version 2 (RFC 2236) is an improvement over version 1 (RFC 1112) but IGMP version 1 is still in wide use. If you would like to read more detailed information about interoperability between IGMP version 2 and version 1, please see sections 4 and 5 of RFC 2236.</p>
Spoof WAN MAC Address	<p>You can use the factory assigned default MAC Address or cloning the MAC address from a computer on your LAN.</p> <p>Otherwise, select the check box next to Spoof WAN MAC Address and enter the IP address of the computer on the LAN whose MAC you are cloning. Once it is successfully configured, the address will be copied to the rom file (ZyNOS configuration file). It will not change unless you change the setting or upload a different ROM file.</p>
Clone the computer's MAC address – IP Address	<p>Enter the IP address of the computer on the LAN whose MAC you are cloning. It is recommended that you clone the MAC address prior to hooking up the WAN port.</p>
Apply	<p>Click Apply to save your changes back to the ZyWALL.</p>
Reset	<p>Click Reset to begin configuring this screen afresh.</p>

8.8 Traffic Redirect

Traffic redirect forwards WAN traffic to a backup gateway when the ZyWALL cannot connect to the Internet through its normal gateway. Connect the backup gateway on the WAN so that the ZyWALL still provides firewall protection for the LAN.

Figure 96 Traffic Redirect WAN Setup

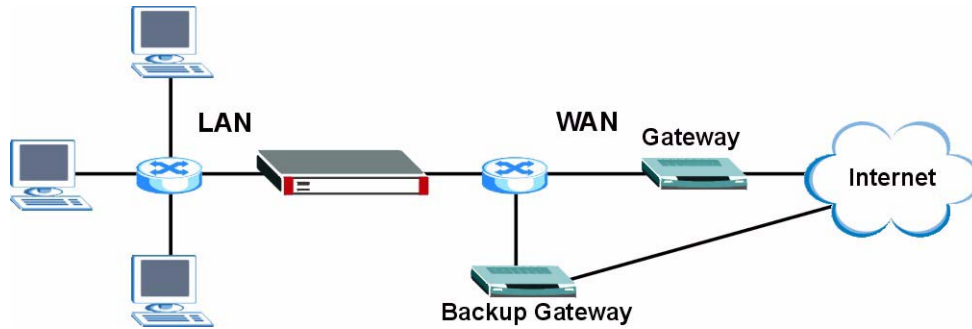

IP alias allows you to avoid triangle route security issues when the backup gateway is connected to the LAN or DMZ. Use IP alias to configure the LAN into two or three logical networks with the ZyWALL itself as the gateway for each LAN network. Put the protected LAN in one subnet (Subnet 1 in the following figure) and the backup gateway in another subnet (Subnet 2). Configure a LAN to LAN/ZyWALL firewall rule that forwards packets from the protected LAN (Subnet 1) to the backup gateway (Subnet 2).

Figure 97 Traffic Redirect LAN Setup

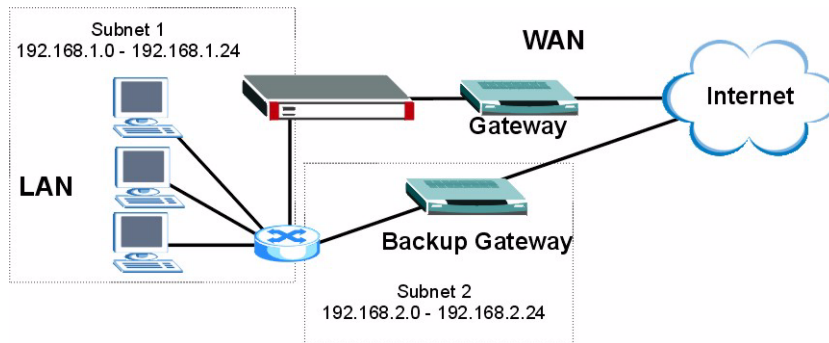

8.9 Configuring Traffic Redirect

To change your ZyWALL's traffic redirect settings, click **NETWORK > WAN > Traffic Redirect**. The screen appears as shown.

Figure 98 NETWORK > WAN > Traffic Redirect

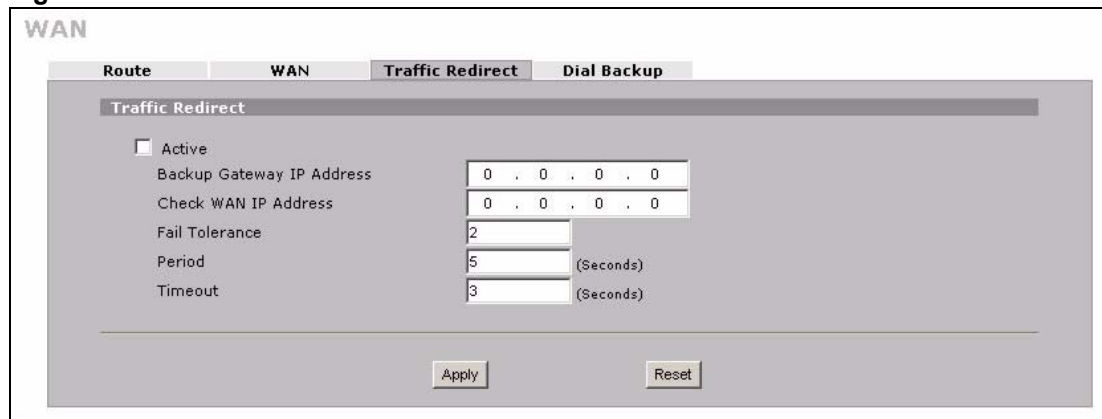

The following table describes the labels in this screen.

Table 35 NETWORK > WAN > Traffic Redirect

LABEL	DESCRIPTION
Active	Select this check box to have the ZyWALL use traffic redirect if the normal WAN connection goes down.
Backup Gateway IP Address	Type the IP address of your backup gateway in dotted decimal notation. The ZyWALL automatically forwards traffic to this IP address if the ZyWALL's Internet connection terminates.
Check WAN IP Address	Configuration of this field is optional. If you do not enter an IP address here, the ZyWALL will use the default gateway IP address. Configure this field to test your ZyWALL's WAN accessibility. Type the IP address of a reliable nearby computer (for example, your ISP's DNS server address).
Fail Tolerance	Type how many WAN connection checks can fail (1 to 10) before the connection is considered "down" (not connected). The ZyWALL still checks a "down" connection to detect if it reconnects.
Period	The ZyWALL tests a WAN connection by periodically sending a ping to either the default gateway or the address in the Check WAN IP Address field. Type a number of seconds (5 to 300) to set the time interval between checks. Allow more time if your destination IP address handles lots of traffic.
Timeout	Type the number of seconds (1 to 10) for your ZyWALL to wait for a response to the ping before considering the check to have failed. This setting must be less than the Period . Use a higher value in this field if your network is busy or congested.
Apply	Click Apply to save your changes back to the ZyWALL.
Reset	Click Reset to begin configuring this screen afresh.

8.10 Configuring Dial Backup

Click **NETWORK > WAN > Dial Backup** to display the **Dial Backup** screen. Use this screen to configure the backup WAN dial-up connection.

Figure 99 NETWORK > WAN > Dial Backup

The following table describes the labels in this screen.

Table 36 NETWORK > WAN > Dial Backup

LABEL	DESCRIPTION
Dial Backup Setup	
Enable Dial Backup	Select this check box to turn on dial backup.
Basic Settings	
Login Name	Type the login name assigned by your ISP.
Password	Type the password assigned by your ISP.
Retype to Confirm	Type your password again to make sure that you have entered is correctly.

Table 36 NETWORK > WAN > Dial Backup (continued)

LABEL	DESCRIPTION
Authentication Type	Use the drop-down list box to select an authentication protocol for outgoing calls. Options are: CHAP/PAP - Your ZyWALL accepts either CHAP or PAP when requested by this remote node. CHAP - Your ZyWALL accepts CHAP only. PAP - Your ZyWALL accepts PAP only.
Primary/ Secondary Phone Number	Type the first (primary) phone number from the ISP for this remote node. If the Primary Phone number is busy or does not answer, your ZyWALL dials the Secondary Phone number if available. Some areas require dialing the pound sign # before the phone number for local calls. Include a # symbol at the beginning of the phone numbers as required.
Dial Backup Port Speed	Use the drop-down list box to select the speed of the connection between the Dial Backup port and the external device. Available speeds are: 9600, 19200, 38400, 57600, 115200 or 230400 bps.
AT Command Initial String	Type the AT command string to initialize the WAN device. Consult the manual of your WAN device connected to your Dial Backup port for specific AT commands.
Advanced Modem Setup	Click Edit to display the Advanced Setup screen and edit the details of your dial backup setup.
TCP/IP Options	
Get IP Address Automatically from Remote Server	Type the login name assigned by your ISP for this remote node.
Used Fixed IP Address	Select this check box if your ISP assigned you a fixed IP address, then enter the IP address in the following field.
My WAN IP Address	Leave the field set to 0.0.0.0 (default) to have the ISP or other remote router dynamically (automatically) assign your WAN IP address if you do not know it. Type your WAN IP address here if you know it (static). This is the address assigned to your local ZyWALL, not the remote router.
Remote IP Subnet Mask	Leave this field set to 0.0.0.0 (default) to have the ISP or other remote router dynamically send its subnet mask if you do not know it. Type the remote gateway's subnet mask here if you know it (static).
Remote Node IP Address	Leave this field set to 0.0.0.0 (default) to have the ISP or other remote router dynamically (automatically) send its IP address if you do not know it. Type the remote gateway's IP address here if you know it (static).
Enable NAT (Network Address Translation)	Network Address Translation (NAT) allows the translation of an Internet protocol address used within one network to a different IP address known within another network. Select the check box to enable NAT. Clear the check box to disable NAT so the ZyWALL does not perform any NAT mapping for the dial backup connection.
Enable RIP	Select this check box to turn on RIP (Routing Information Protocol), which allows a router to exchange routing information with other routers.
RIP Version	The RIP Version field controls the format and the broadcasting method of the RIP packets that the ZyWALL sends (it recognizes both formats when receiving). Choose RIP-1, RIP-2B or RIP-2M . RIP-1 is universally supported; but RIP-2 carries more information. RIP-1 is probably adequate for most networks, unless you have an unusual network topology. Both RIP-2B and RIP-2M sends the routing data in RIP-2 format; the difference being that RIP-2B uses subnet broadcasting while RIP-2M uses multicasting. Multicasting can reduce the load on non-router machines since they generally do not listen to the RIP multicast address and so will not receive the RIP packets. However, if one router uses multicasting, then all routers on your network must use multicasting, also.

Table 36 NETWORK > WAN > Dial Backup (continued)

LABEL	DESCRIPTION
RIP Direction	RIP (Routing Information Protocol) allows a router to exchange routing information with other routers. The RIP Direction field controls the sending and receiving of RIP packets. Choose Both , In Only or Out Only . When set to Both or Out Only , the ZyWALL will broadcast its routing table periodically. When set to Both or In Only , the ZyWALL will incorporate RIP information that it receives.
Broadcast Dial Backup Route	Select this check box to forward the backup route broadcasts to the WAN.
Enable Multicast	Select this check box to turn on IGMP (Internet Group Multicast Protocol). IGMP is a network-layer protocol used to establish membership in a Multicast group - it is not used to carry user data.
Multicast Version	Select IGMP-v1 or IGMP-v2 . IGMP version 2 (RFC 2236) is an improvement over version 1 (RFC 1112) but IGMP version 1 is still in wide use. If you would like to read more detailed information about interoperability between IGMP version 2 and version 1, please see <i>sections 4 and 5 of RFC 2236</i> .
PPP Options	
PPP Encapsulation	Select CISCO PPP from the drop-down list box if your dial backup WAN device uses Cisco PPP encapsulation, otherwise select Standard PPP .
Enable Compression	Select this check box to turn on stac compression.
Budget	
Always On	Select this check box to have the dial backup connection on all of the time.
Configure Budget	Select this check box to have the dial backup connection on during the time that you select.
Allocated Budget	Type the amount of time (in minutes) that the dial backup connection can be used during the time configured in the Period field. Set an amount that is less than the time period configured in the Period field.
Period	Type the time period (in hours) for how often the budget should be reset. For example, to allow calls to this remote node for a maximum of 10 minutes every hour, set the Allocated Budget to 10 (minutes) and the Period to 1 (hour).
Idle Timeout	Type the number of seconds of idle time (when there is no traffic from the ZyWALL to the remote node) for the ZyWALL to wait before it automatically disconnects the dial backup connection. This option applies only when the ZyWALL initiates the call. The dial backup connection never times out if you set this field to "0" (it is the same as selecting Always On).
Apply	Click Apply to save your changes back to the ZyWALL.
Reset	Click Reset to begin configuring this screen afresh.

8.11 Advanced Modem Setup

8.11.1 AT Command Strings

For regular telephone lines, the default Dial string tells the modem that the line uses tone dialing. ATDT is the command for a switch that requires tone dialing. If your switch requires pulse dialing, change the string to ATDP.

For ISDN lines, there are many more protocols and operational modes. Please consult the documentation of your TA. You may need additional commands in both Dial and Init strings.

8.11.2 DTR Signal

The majority of WAN devices default to hanging up the current call when the DTR (Data Terminal Ready) signal is dropped by the DTE. When the Drop DTR When Hang Up check box is selected, the ZyWALL uses this hardware signal to force the WAN device to hang up, in addition to issuing the drop command ATH.

8.11.3 Response Strings

The response strings tell the ZyWALL the tags, or labels, immediately preceding the various call parameters sent from the WAN device. The response strings have not been standardized; please consult the documentation of your WAN device to find the correct tags.

8.12 Configuring Advanced Modem Setup

Click the **Edit** button in the **Dial Backup** screen to display the **Advanced Setup** screen.



Consult the manual of your WAN device connected to your dial backup port for specific AT commands.

Figure 100 NETWORK > WAN > Dial Backup > Edit

WAN - ADVANCED MODEM SETUP

AT Command Strings

Dial	<input type="text" value="atdt"/>
Drop	<input type="text" value="~~~+++~ath"/>
Answer	<input type="text" value="ata"/>

Drop DTR When Hang Up

AT Response Strings

CLID	<input type="text" value="NUMBER ="/>
Called ID	<input type="text"/>
Speed	<input type="text" value="CONNECT"/>

Call Control

Dial Timeout (sec)	<input type="text" value="60"/>
Retry Count	<input type="text" value="0"/>
Retry Interval (sec)	<input type="text" value="10"/>
Drop Timeout (sec)	<input type="text" value="20"/>
Call Back Delay (sec)	<input type="text" value="15"/>

The following table describes the labels in this screen.

Table 37 NETWORK > WAN > Dial Backup > Edit

LABEL	DESCRIPTION
AT Command Strings	
Dial	Type the AT Command string to make a call.
Drop	Type the AT Command string to drop a call. "~" represents a one second wait, for example, "~~~+++~ath" can be used if your modem has a slow response time.
Answer	Type the AT Command string to answer a call.
Drop DTR When Hang Up	Select this check box to have the ZyWALL drop the DTR (Data Terminal Ready) signal after the "AT Command String: Drop" is sent out.
AT Response Strings	
CLID	Type the keyword that precedes the CLID (Calling Line Identification) in the AT response string. This lets the ZyWALL capture the CLID in the AT response string that comes from the WAN device. CLID is required for CLID authentication.
Called ID	Type the keyword preceding the dialed number.
Speed	Type the keyword preceding the connection speed.
Call Control	
Dial Timeout (sec)	Type a number of seconds for the ZyWALL to try to set up an outgoing call before timing out (stopping).
Retry Count	Type a number of times for the ZyWALL to retry a busy or no-answer phone number before blacklisting the number.
Retry Interval (sec)	Type a number of seconds for the ZyWALL to wait before trying another call after a call has failed. This applies before a phone number is blacklisted.
Drop Timeout (sec)	Type the number of seconds for the ZyWALL to wait before dropping the DTR signal if it does not receive a positive disconnect confirmation.
Call Back Delay (sec)	Type a number of seconds for the ZyWALL to wait between dropping a callback request call and dialing the corresponding callback call.
Apply	Click Apply to save your changes back to the ZyWALL.
Cancel	Click Cancel to exit this screen without saving.

DMZ Screens

This chapter describes how to configure the ZyWALL's DMZ.

9.1 DMZ

The DeMilitarized Zone (DMZ) provides a way for public servers (Web, e-mail, FTP, etc.) to be visible to the outside world (while still being protected from DoS (Denial of Service) attacks such as SYN flooding and Ping of Death). These public servers can also still be accessed from the secure LAN.

By default the firewall allows traffic between the WAN and the DMZ, traffic from the DMZ to the LAN is denied, and traffic from the LAN to the DMZ is allowed. Internet users can have access to host servers on the DMZ but no access to the LAN, unless special filter rules allowing access were configured by the administrator or the user is an authorized remote user.

It is highly recommended that you connect all of your public servers to the DMZ port(s).

It is also highly recommended that you keep all sensitive information off of the public servers connected to the DMZ port. Store sensitive information on LAN computers.

9.2 Configuring DMZ

The DMZ and the connected computers can have private or public IP addresses.

When the DMZ uses public IP addresses, the WAN and DMZ ports must use public IP addresses that are on separate subnets. See [Appendix D on page 607](#) for information on IP subnetting. If you do not configure SUA NAT or any full feature NAT mapping rules for the public IP addresses on the DMZ, the ZyWALL will route traffic to the public IP addresses on the DMZ without performing NAT. This may be useful for hosting servers for NAT unfriendly applications (see [Chapter 17 on page 307](#) for more information).

If the DMZ computers use private IP addresses, use NAT if you want to make them publicly accessible.

Like the LAN, the ZyWALL can also assign TCP/IP configuration via DHCP to computers connected to the DMZ ports.

From the main menu, click **NETWORK > DMZ** to open the **DMZ** screen. The screen appears as shown next.

Figure 101 NETWORK > DMZ

The following table describes the labels in this screen.

Table 38 NETWORK > DMZ

LABEL	DESCRIPTION
DMZ TCP/IP	
IP Address	Type the IP address of your ZyWALL's DMZ port in dotted decimal notation. Note: Make sure the IP addresses of the LAN, WAN, WLAN and DMZ are on separate subnets.
IP Subnet Mask	The subnet mask specifies the network number portion of an IP address. Your ZyWALL will automatically calculate the subnet mask based on the IP address that you assign. Unless you are implementing subnetting, use the subnet mask computed by the ZyWALL 255.255.255.0.
RIP Direction	RIP (Routing Information Protocol, RFC1058 and RFC 1389) allows a router to exchange routing information with other routers. The RIP Direction field controls the sending and receiving of RIP packets. Select the RIP direction from Both/In Only/Out Only/None . When set to Both or Out Only , the ZyWALL will broadcast its routing table periodically. When set to Both or In Only , it will incorporate the RIP information that it receives; when set to None , it will not send any RIP packets and will ignore any RIP packets received. Both is the default.
RIP Version	The RIP Version field controls the format and the broadcasting method of the RIP packets that the ZyWALL sends (it recognizes both formats when receiving). RIP-1 is universally supported but RIP-2 carries more information. RIP-1 is probably adequate for most networks, unless you have an unusual network topology. Both RIP-2B and RIP-2M sends the routing data in RIP-2 format; the difference being that RIP-2B uses subnet broadcasting while RIP-2M uses multicasting. Multicasting can reduce the load on non-router machines since they generally do not listen to the RIP multicast address and so will not receive the RIP packets. However, if one router uses multicasting, then all routers on your network must use multicasting, also. By default, RIP direction is set to Both and the Version set to RIP-1 .

Table 38 NETWORK > DMZ (continued)

LABEL	DESCRIPTION
Multicast	Select IGMP V-1 or IGMP V-2 or None . IGMP (Internet Group Multicast Protocol) is a network-layer protocol used to establish membership in a Multicast group - it is not used to carry user data. IGMP version 2 (RFC 2236) is an improvement over version 1 (RFC 1112) but IGMP version 1 is still in wide use. If you would like to read more detailed information about interoperability between IGMP version 2 and version 1, please see <i>sections 4 and 5 of RFC 2236</i> .
DHCP Setup	
DHCP	DHCP (Dynamic Host Configuration Protocol, RFC 2131 and RFC 2132) allows individual clients (workstations) to obtain TCP/IP configuration at startup from a server. Unless you are instructed by your ISP, leave this field set to Server . When configured as a server, the ZyWALL provides TCP/IP configuration for the clients. When set as a server, fill in the IP Pool Starting Address and Pool Size fields. Select Relay to have the ZyWALL forward DHCP requests to another DHCP server. When set to Relay , fill in the DHCP Server Address field. Select None to stop the ZyWALL from acting as a DHCP server. When you select None , you must have another DHCP server on your LAN, or else the computers must be manually configured.
IP Pool Starting Address	This field specifies the first of the contiguous addresses in the IP address pool.
Pool Size	This field specifies the size, or count of the IP address pool.
DHCP Server Address	Type the IP address of the DHCP server to which you want the ZyWALL to relay DHCP requests. Use dotted decimal notation. Alternatively, click the right mouse button to copy and/or paste the IP address.
DHCP WINS Server 1, 2	Type the IP address of the WINS (Windows Internet Naming Service) server that you want to send to the DHCP clients. The WINS server keeps a mapping table of the computer names on your network and the IP addresses that they are currently using.
Windows Networking (NetBIOS over TCP/IP)	
Allow between DMZ and LAN	Select this check box to forward NetBIOS packets from the LAN to the DMZ and from the DMZ to the LAN. If your firewall is enabled with the default policy set to block DMZ to LAN traffic, you also need to configure a DMZ to LAN firewall rule that forwards NetBIOS traffic. Clear this check box to block all NetBIOS packets going from the LAN to the DMZ and from the DMZ to the LAN.
Allow between DMZ and WAN	Select this check box to forward NetBIOS packets from the DMZ to the WAN and from the WAN to the DMZ. Clear this check box to block all NetBIOS packets going from the DMZ to the WAN and from the WAN to the DMZ.
Allow between DMZ and WLAN	Select this check box to forward NetBIOS packets from the WLAN to the DMZ and from the DMZ to the WLAN. If your firewall is enabled with the default policy set to block DMZ to WLAN traffic and WLAN to DMZ traffic, you also need to configure DMZ to WLAN and WLAN to DMZ firewall rules that forward NetBIOS traffic. Clear this check box to block all NetBIOS packets going from the WLAN to the DMZ and from the DMZ to the WLAN.
Apply	Click Apply to save your changes back to the ZyWALL.
Reset	Click Reset to begin configuring this screen afresh.

9.3 DMZ Static DHCP

This table allows you to assign IP addresses on the DMZ to specific individual computers based on their MAC addresses.

Every Ethernet device has a unique MAC (Media Access Control) address. The MAC address is assigned at the factory and consists of six pairs of hexadecimal characters, for example, 00:A0:C5:00:00:02.

To change your ZyWALL's static DHCP settings on the DMZ, click **NETWORK > DMZ > Static DHCP**. The screen appears as shown.

Figure 102 NETWORK > DMZ > Static DHCP

DMZ

DMZ Static DHCP IP Alias Port Roles

Static DHCP Table

#	MAC Address	IP Address
1	<input type="text"/>	0 . 0 . 0 . 0
2	<input type="text"/>	0 . 0 . 0 . 0
3	<input type="text"/>	0 . 0 . 0 . 0
4	<input type="text"/>	0 . 0 . 0 . 0
5	<input type="text"/>	0 . 0 . 0 . 0
6	<input type="text"/>	0 . 0 . 0 . 0
7	<input type="text"/>	0 . 0 . 0 . 0
8	<input type="text"/>	0 . 0 . 0 . 0
9	<input type="text"/>	0 . 0 . 0 . 0
10	<input type="text"/>	0 . 0 . 0 . 0
11	<input type="text"/>	0 . 0 . 0 . 0
12	<input type="text"/>	0 . 0 . 0 . 0
13	<input type="text"/>	0 . 0 . 0 . 0
14	<input type="text"/>	0 . 0 . 0 . 0
15	<input type="text"/>	0 . 0 . 0 . 0
16	<input type="text"/>	0 . 0 . 0 . 0
17	<input type="text"/>	0 . 0 . 0 . 0
18	<input type="text"/>	0 . 0 . 0 . 0
19	<input type="text"/>	0 . 0 . 0 . 0
20	<input type="text"/>	0 . 0 . 0 . 0
21	<input type="text"/>	0 . 0 . 0 . 0
22	<input type="text"/>	0 . 0 . 0 . 0
23	<input type="text"/>	0 . 0 . 0 . 0
24	<input type="text"/>	0 . 0 . 0 . 0
25	<input type="text"/>	0 . 0 . 0 . 0
26	<input type="text"/>	0 . 0 . 0 . 0
27	<input type="text"/>	0 . 0 . 0 . 0
28	<input type="text"/>	0 . 0 . 0 . 0
29	<input type="text"/>	0 . 0 . 0 . 0
30	<input type="text"/>	0 . 0 . 0 . 0
31	<input type="text"/>	0 . 0 . 0 . 0
32	<input type="text"/>	0 . 0 . 0 . 0

Apply Reset

The following table describes the labels in this screen.

Table 39 NETWORK > DMZ > Static DHCP

LABEL	DESCRIPTION
#	This is the index number of the Static IP table entry (row).
MAC Address	Type the MAC address of a computer on your DMZ.
IP Address	Type the IP address that you want to assign to the computer on your DMZ. Alternatively, click the right mouse button to copy and/or paste the IP address.
Apply	Click Apply to save your changes back to the ZyWALL.
Reset	Click Reset to begin configuring this screen afresh.

9.4 DMZ IP Alias

IP alias allows you to partition a physical network into different logical networks over the same Ethernet interface.

The ZyWALL has a single DMZ interface. Even though more than one of ports 1~4 may be in the DMZ port role, they are all still part of a single physical Ethernet interface and all use the same IP address.

The ZyWALL supports three logical DMZ interfaces via its single physical DMZ Ethernet interface. The ZyWALL itself is the gateway for each of the logical DMZ networks.

The IP alias IP addresses can be either private or public regardless of whether the physical DMZ interface is set to use a private or public IP address. Use NAT if you want to make DMZ computers with private IP addresses publicly accessible (see [Chapter 17 on page 307](#) for more information). When you use IP alias, you can have the DMZ use both public and private IP addresses at the same time.



Make sure that the subnets of the logical networks do not overlap.

To change your ZyWALL's IP alias settings, click **NETWORK > DMZ > IP Alias**. The screen appears as shown.

Figure 103 NETWORK > DMZ > IP Alias

The following table describes the labels in this screen.

Table 40 NETWORK > DMZ > IP Alias

LABEL	DESCRIPTION
Enable IP Alias 1, 2	Select the check box to configure another DMZ network for the ZyWALL.
IP Address	Enter the IP address of your ZyWALL in dotted decimal notation. Note: Make sure the IP addresses of the LAN, WAN, WLAN and DMZ are on separate subnets.
IP Subnet Mask	Your ZyWALL will automatically calculate the subnet mask based on the IP address that you assign. Unless you are implementing subnetting, use the subnet mask computed by the ZyWALL.
RIP Direction	RIP (Routing Information Protocol, RFC1058 and RFC 1389) allows a router to exchange routing information with other routers. The RIP Direction field controls the sending and receiving of RIP packets. Select the RIP direction from Both/In Only/Out Only/None . When set to Both or Out Only , the ZyWALL will broadcast its routing table periodically. When set to Both or In Only , it will incorporate the RIP information that it receives; when set to None , it will not send any RIP packets and will ignore any RIP packets received.
RIP Version	The RIP Version field controls the format and the broadcasting method of the RIP packets that the ZyWALL sends (it recognizes both formats when receiving). RIP-1 is universally supported but RIP-2 carries more information. RIP-1 is probably adequate for most networks, unless you have an unusual network topology. Both RIP-2B and RIP-2M sends the routing data in RIP-2 format; the difference being that RIP-2B uses subnet broadcasting while RIP-2M uses multicasting. Multicasting can reduce the load on non-router machines since they generally do not listen to the RIP multicast address and so will not receive the RIP packets. However, if one router uses multicasting, then all routers on your network must use multicasting, also. By default, RIP direction is set to Both and the Version set to RIP-1 .
Apply	Click Apply to save your changes back to the ZyWALL.
Reset	Click Reset to begin configuring this screen afresh.

9.5 DMZ Public IP Address Example

The following figure shows a simple network setup with public IP addresses on the WAN and DMZ and private IP addresses on the LAN. Lower case letters represent public IP addresses (like a.b.c.d for example). The LAN port and connected computers (A through C) use private IP addresses that are in one subnet. The DMZ port and connected servers (D through F) use public IP addresses that are in another subnet. The public IP addresses of the DMZ and WAN ports are in separate subnets.

Figure 104 DMZ Public Address Example
LAN

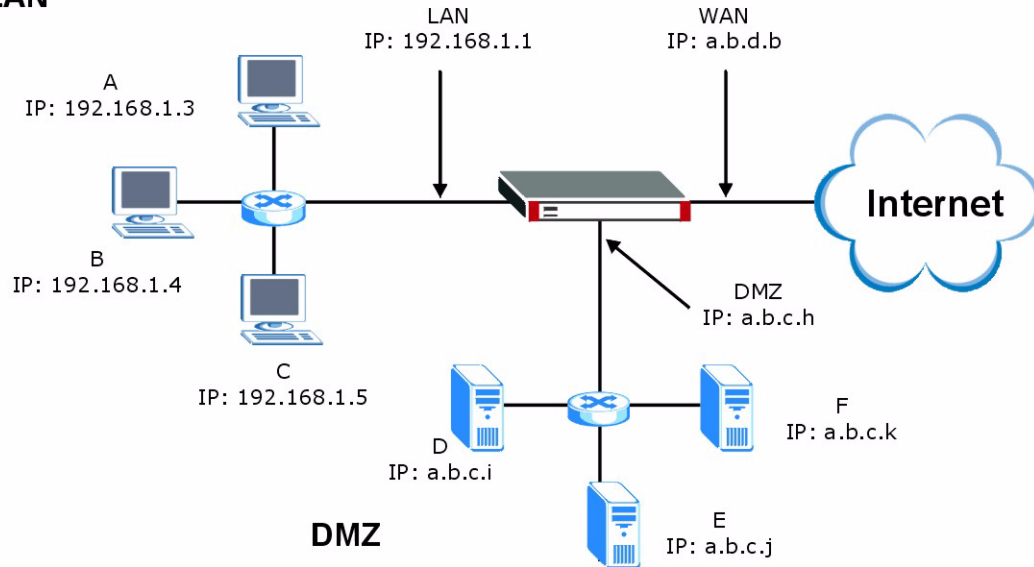

9.6 DMZ Private and Public IP Address Example

The following figure shows a network setup with both private and public IP addresses on the DMZ. Lower case letters represent public IP addresses (like a.b.c.d for example). The LAN port and connected computers (A through C) use private IP addresses that are in one subnet. The DMZ port and server F use private IP addresses that are in one subnet. The private IP addresses of the LAN and DMZ are on separate subnets. The DMZ port and connected servers (D and E) use public IP addresses that are in one subnet. The public IP addresses of the DMZ and WAN are on separate subnets.

Configure one subnet (either the public or the private) in the **Network > DMZ** screen (see [Figure 9.2 on page 161](#)) and configure the other subnet in the **Network > DMZ > IP Alias** screen (see [Figure 9.4 on page 165](#)) to use this kind of network setup. You also need to configure NAT for the private DMZ IP addresses.

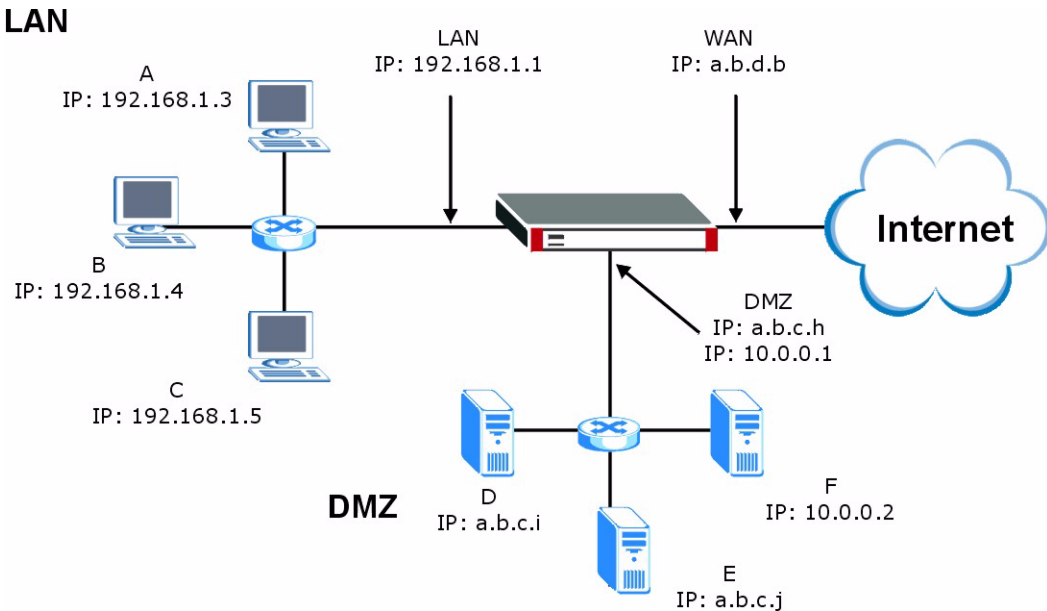
Figure 105 DMZ Private and Public Address Example

9.7 DMZ Port Roles

Use the **Port Roles** screen to set ports as part of the LAN, DMZ and/or WLAN interface.

Ports 1~4 on the ZyWALL can be part of the LAN, DMZ or WLAN interface.



Do the following if you are configuring from a computer connected to a LAN, DMZ or WLAN port and changing the port's role:

- 1 A port's IP address varies as its role changes, make sure your computer's IP address is in the same subnet as the ZyWALL's LAN, DMZ or WLAN IP address.
- 2 Use the appropriate LAN, DMZ or WLAN IP address to access the ZyWALL.

To change your ZyWALL's port role settings, click **NETWORK > DMZ > Port Roles**. The screen appears as shown.

The radio buttons correspond to Ethernet ports on the front panel of the ZyWALL. On the ZyWALL, ports 1 to 4 are all LAN ports by default.

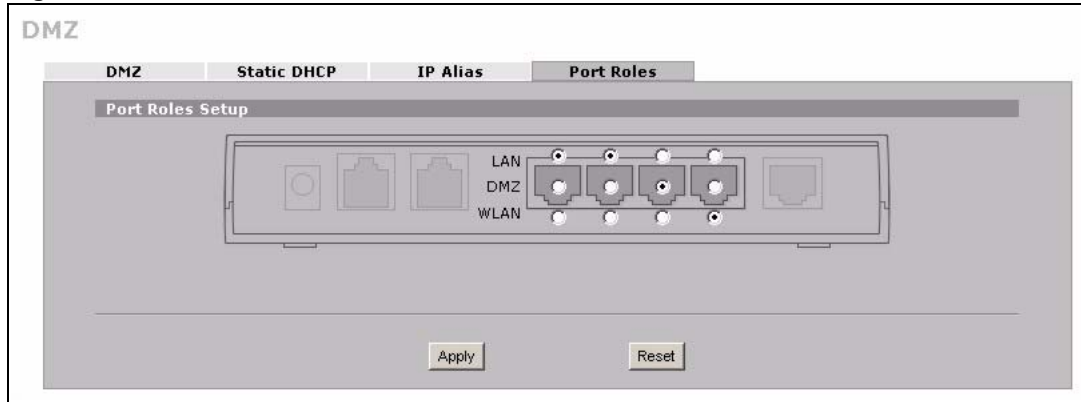

Your changes are also reflected in the LAN and/or WLAN Port Roles screens.

Figure 106 NETWORK > DMZ > Port Roles

The following table describes the labels in this screen.

Table 41 NETWORK > DMZ > Port Roles

LABEL	DESCRIPTION
LAN	Select a port's LAN radio button to use the port as part of the LAN. The port will use the ZyWALL's LAN IP address and MAC address.
DMZ	Select a port's DMZ radio button to use the port as part of the DMZ. The port will use the ZyWALL's DMZ IP address and MAC address.
WLAN	Select a port's WLAN radio button to use the port as part of the WLAN. The port will use the ZyWALL's WLAN IP address and MAC address.
Apply	Click Apply to save your changes back to the ZyWALL.
Reset	Click Reset to begin configuring this screen afresh.

Wireless LAN

This chapter discusses how to configure wireless LAN on the ZyWALL.

10.1 Wireless LAN Introduction

A wireless LAN can be as simple as two computers with wireless LAN adapters communicating in a peer-to-peer network or as complex as a number of computers with wireless LAN adapters communicating through access points which bridge network traffic to the wired LAN. To add a wireless network to the ZyWALL, you can connect an Access Point to a port in the WLAN role.

10.2 Configuring WLAN

To add wireless functionality to the ZyWALL, use the **Port Roles** screen (see [Figure 111 on page 178](#)) to set a port to be part of the WLAN and connect an access point (AP) to the WLAN interface.

Click **NETWORK > WLAN** to open the **WLAN** screen to configure the IP address for ZyWALL's WLAN interface, other TCP/IP and DHCP settings.

Figure 107 NETWORK > WLAN

The following table describes the labels in this screen.

Table 42 NETWORK > WLAN

LABEL	DESCRIPTION
WLAN TCP/IP	
IP Address	Type the IP address of your ZyWALL's WLAN interface in dotted decimal notation. Alternatively, click the right mouse button to copy and/or paste the IP address. Note: Make sure the IP addresses of the LAN, WAN, WLAN and DMZ are on separate subnets.
IP Subnet Mask	The subnet mask specifies the network number portion of an IP address. Your ZyWALL automatically calculates the subnet mask based on the IP address that you assign. Unless you are implementing subnetting, use the subnet mask computed by the ZyWALL.
RIP Direction	RIP (Routing Information Protocol, RFC1058 and RFC 1389) allows a router to exchange routing information with other routers. The RIP Direction field controls the sending and receiving of RIP packets. Select the RIP direction from Both/In Only/Out Only/None . When set to Both or Out Only , the ZyWALL will broadcast its routing table periodically. When set to Both or In Only , it will incorporate the RIP information that it receives; when set to None , it will not send any RIP packets and will ignore any RIP packets received. Both is the default.
RIP Version	The RIP Version field controls the format and the broadcasting method of the RIP packets that the ZyWALL sends (it recognizes both formats when receiving). RIP-1 is universally supported but RIP-2 carries more information. RIP-1 is probably adequate for most networks, unless you have an unusual network topology. Both RIP-2B and RIP-2M sends the routing data in RIP-2 format; the difference being that RIP-2B uses subnet broadcasting while RIP-2M uses multicasting. Multicasting can reduce the load on non-router machines since they generally do not listen to the RIP multicast address and so will not receive the RIP packets. However, if one router uses multicasting, then all routers on your network must use multicasting, also. By default, RIP direction is set to Both and the Version set to RIP-1 .

Table 42 NETWORK > WLAN (continued)

LABEL	DESCRIPTION
Multicast	Select IGMP V-1 or IGMP V-2 or None . IGMP (Internet Group Multicast Protocol) is a network-layer protocol used to establish membership in a Multicast group - it is not used to carry user data. IGMP version 2 (RFC 2236) is an improvement over version 1 (RFC 1112) but IGMP version 1 is still in wide use. If you would like to read more detailed information about interoperability between IGMP version 2 and version 1, please see <i>sections 4 and 5 of RFC 2236</i> .
DHCP Setup	
DHCP	DHCP (Dynamic Host Configuration Protocol, RFC 2131 and RFC 2132) allows individual clients (workstations) to obtain TCP/IP configuration at startup from a server. Unless you are instructed by your ISP, leave this field set to Server . When configured as a server, the ZyWALL provides TCP/IP configuration for the clients. When set as a server, fill in the IP Pool Starting Address and Pool Size fields. Select Relay to have the ZyWALL forward DHCP requests to another DHCP server. When set to Relay , fill in the DHCP Server Address field. Select None to stop the ZyWALL from acting as a DHCP server. When you select None , you must have another DHCP server on your WLAN, or else the computers must be manually configured.
IP Pool Starting Address	This field specifies the first of the contiguous addresses in the IP address pool.
Pool Size	This field specifies the size, or count of the IP address pool.
DHCP Server Address	Type the IP address of the DHCP server to which you want the ZyWALL to relay DHCP requests. Use dotted decimal notation. Alternatively, click the right mouse button to copy and/or paste the IP address.
DHCP WINS Server 1, 2	Type the IP address of the WINS (Windows Internet Naming Service) server that you want to send to the DHCP clients. The WINS server keeps a mapping table of the computer names on your network and the IP addresses that they are currently using.
Windows Networking (NetBIOS over TCP/IP)	NetBIOS (Network Basic Input/Output System) are TCP or UDP packets that enable a computer to connect to and communicate with a LAN. For some dial-up services such as PPPoE or PPTP, NetBIOS packets cause unwanted calls. However it may sometimes be necessary to allow NetBIOS packets to pass through to the WAN in order to find a computer on the WAN.
Allow between WLAN and LAN	Select this check box to forward NetBIOS packets from the WLAN to the LAN and from the LAN to the WLAN. Clear this check box to block all NetBIOS packets going from the LAN to the WLAN and from the WLAN to the LAN.
Allow between WLAN and WAN	Select this check box to forward NetBIOS packets from the WLAN to the WAN and from the WAN to the WLAN. Clear this check box to block all NetBIOS packets going from the WLAN to the WAN and from the WAN to the WLAN.
Allow between WLAN and DMZ	Select this check box to forward NetBIOS packets from the WLAN to the DMZ and from the DMZ to the WLAN. If your firewall is enabled with the default policy set to block WLAN to DMZ traffic and DMZ to WLAN traffic, you also need to configure WLAN to DMZ and DMZ to WLAN firewall rules that forward NetBIOS traffic. Clear this check box to block all NetBIOS packets going from the WLAN to the DMZ and from the DMZ to the WLAN.
Apply	Click Apply to save your changes back to the ZyWALL.
Reset	Click Reset to begin configuring this screen afresh.

10.3 WLAN Static DHCP

This table allows you to assign IP addresses on the WLAN to specific individual computers based on their MAC addresses.

Every Ethernet device has a unique MAC (Media Access Control) address. The MAC address is assigned at the factory and consists of six pairs of hexadecimal characters, for example, 00:A0:C5:00:00:02.

To change your ZyWALL's WLAN static DHCP settings, click **NETWORK > WLAN > Static DHCP**. The screen appears as shown.

Figure 108 NETWORK > WLAN > Static DHCP

WLAN

WLAN Static DHCP IP Alias Port Roles

Static DHCP Table

#	MAC Address	IP Address
1	<input type="text"/>	0 . 0 . 0 . 0
2	<input type="text"/>	0 . 0 . 0 . 0
3	<input type="text"/>	0 . 0 . 0 . 0
4	<input type="text"/>	0 . 0 . 0 . 0
5	<input type="text"/>	0 . 0 . 0 . 0
6	<input type="text"/>	0 . 0 . 0 . 0
7	<input type="text"/>	0 . 0 . 0 . 0
8	<input type="text"/>	0 . 0 . 0 . 0
9	<input type="text"/>	0 . 0 . 0 . 0
10	<input type="text"/>	0 . 0 . 0 . 0
11	<input type="text"/>	0 . 0 . 0 . 0
12	<input type="text"/>	0 . 0 . 0 . 0
13	<input type="text"/>	0 . 0 . 0 . 0
14	<input type="text"/>	0 . 0 . 0 . 0
15	<input type="text"/>	0 . 0 . 0 . 0
16	<input type="text"/>	0 . 0 . 0 . 0
17	<input type="text"/>	0 . 0 . 0 . 0
18	<input type="text"/>	0 . 0 . 0 . 0
19	<input type="text"/>	0 . 0 . 0 . 0
20	<input type="text"/>	0 . 0 . 0 . 0
21	<input type="text"/>	0 . 0 . 0 . 0
22	<input type="text"/>	0 . 0 . 0 . 0
23	<input type="text"/>	0 . 0 . 0 . 0
24	<input type="text"/>	0 . 0 . 0 . 0
25	<input type="text"/>	0 . 0 . 0 . 0
26	<input type="text"/>	0 . 0 . 0 . 0
27	<input type="text"/>	0 . 0 . 0 . 0
28	<input type="text"/>	0 . 0 . 0 . 0
29	<input type="text"/>	0 . 0 . 0 . 0
30	<input type="text"/>	0 . 0 . 0 . 0
31	<input type="text"/>	0 . 0 . 0 . 0
32	<input type="text"/>	0 . 0 . 0 . 0

Apply Reset

The following table describes the labels in this screen.

Table 43 NETWORK > WLAN > Static DHCP

LABEL	DESCRIPTION
#	This is the index number of the Static IP table entry (row).
MAC Address	Type the MAC address of a computer on your WLAN.
IP Address	Type the IP address that you want to assign to the computer on your WLAN. Alternatively, click the right mouse button to copy and/or paste the IP address.
Apply	Click Apply to save your changes back to the ZyWALL.
Reset	Click Reset to begin configuring this screen afresh.

10.4 WLAN IP Alias

IP alias allows you to partition a physical network into different logical networks over the same Ethernet interface.

The ZyWALL has a single WLAN interface. Even though more than one of ports 1~4 may be in the WLAN port role, they are all still part of a single physical Ethernet interface and all use the same IP address.

The ZyWALL supports three logical WLAN interfaces via its single physical WLAN Ethernet interface. The ZyWALL itself is the gateway for each of the logical WLAN networks.

When you use IP alias, you can also configure firewall rules to control access between the WLAN's logical networks (subnets).



Make sure that the subnets of the logical networks do not overlap.

To change your ZyWALL's IP alias settings, click **NETWORK > WLAN > IP Alias**. The screen appears as shown.

Figure 109 NETWORK > WLAN > IP Alias

The screenshot shows the 'WLAN' configuration page with the 'IP Alias' tab selected. It contains two identical sections for 'IP Alias 1' and 'IP Alias 2'. In the 'IP Alias 1' section, the 'Enable IP Alias 1' checkbox is checked. The IP Address and IP Subnet Mask fields both contain '0 . 0 . 0 . 0'. The RIP Direction is set to 'None' and the RIP Version is set to 'RIP-1'. The 'IP Alias 2' section has the 'Enable IP Alias 2' checkbox unchecked and the same IP address and subnet mask values. At the bottom of the page are 'Apply' and 'Reset' buttons.

The following table describes the labels in this screen.

Table 44 NETWORK > WLAN > IP Alias

LABEL	DESCRIPTION
Enable IP Alias 1, 2	Select the check box to configure another WLAN network for the ZyWALL.
IP Address	Enter the IP address of your ZyWALL in dotted decimal notation. Alternatively, click the right mouse button to copy and/or paste the IP address.
IP Subnet Mask	Your ZyWALL will automatically calculate the subnet mask based on the IP address that you assign. Unless you are implementing subnetting, use the subnet mask computed by the ZyWALL.
RIP Direction	RIP (Routing Information Protocol, RFC 1058 and RFC 1389) allows a router to exchange routing information with other routers. The RIP Direction field controls the sending and receiving of RIP packets. Select the RIP direction from Both/In Only/Out Only/None . When set to Both or Out Only , the ZyWALL will broadcast its routing table periodically. When set to Both or In Only , it will incorporate the RIP information that it receives; when set to None , it will not send any RIP packets and will ignore any RIP packets received.
RIP Version	The RIP Version field controls the format and the broadcasting method of the RIP packets that the ZyWALL sends (it recognizes both formats when receiving). RIP-1 is universally supported but RIP-2 carries more information. RIP-1 is probably adequate for most networks, unless you have an unusual network topology. Both RIP-2B and RIP-2M sends the routing data in RIP-2 format; the difference being that RIP-2B uses subnet broadcasting while RIP-2M uses multicasting. Multicasting can reduce the load on non-router machines since they generally do not listen to the RIP multicast address and so will not receive the RIP packets. However, if one router uses multicasting, then all routers on your network must use multicasting, also. By default, RIP direction is set to Both and the Version set to RIP-1 .
Apply	Click Apply to save your changes back to the ZyWALL.
Reset	Click Reset to begin configuring this screen afresh.

10.5 WLAN Port Roles

Use the **Port Roles** screen to set ports as part of the LAN, DMZ and/or WLAN interface.

Ports 1~4 on the ZyWALL can be part of the LAN, DMZ or WLAN interface.

Connect wireless LAN Access Points (APs) to WLAN interfaces to extend the ZyWALL's wireless LAN coverage. The WLAN port role allows the ZyWALL's firewall to treat traffic from connected APs as part of the ZyWALL's WLAN. You can specify firewall rules for traffic going to or from the WLAN. The WLAN includes the Ethernet ports in the WLAN port role.

The following figure shows the ZyWALL with an AP connected to an Ethernet port in the WLAN port role.

Figure 110 WLAN Port Role Example

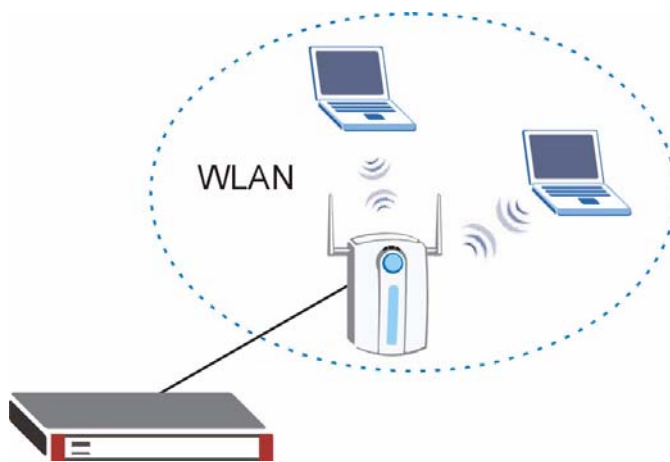

Do the following if you are configuring from a computer connected to a LAN, DMZ or WLAN port and changing the port's role:

- 1 A port's IP address varies as its role changes, make sure your computer's IP address is in the same subnet as the ZyWALL's LAN, DMZ or WLAN IP address.
- 2 Use the appropriate LAN, DMZ or WLAN IP address to access the ZyWALL.

To change your ZyWALL's port role settings, click **NETWORK > WLAN > Port Roles**. The screen appears as shown.

The radio buttons correspond to Ethernet ports on the front panel of the ZyWALL. On the ZyWALL, ports 1 to 4 are all LAN ports by default.

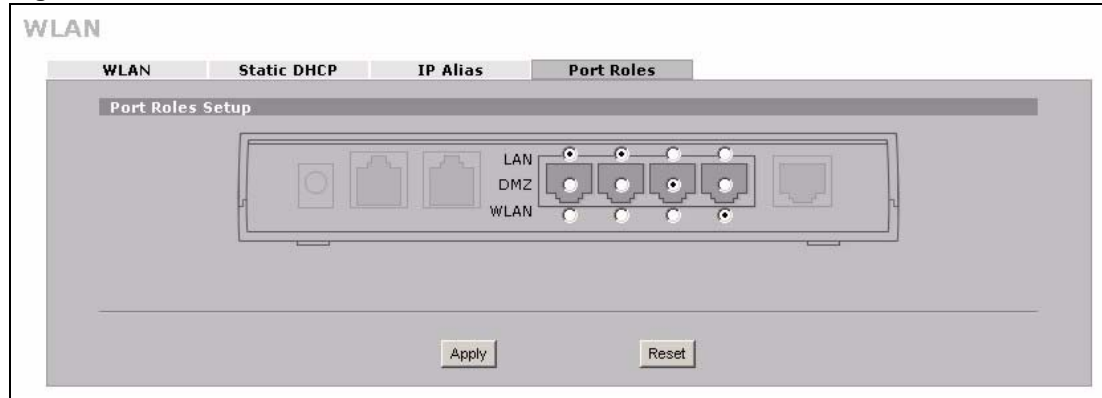

Your changes are also reflected in the LAN and DMZ Port Roles screen.

Figure 111 NETWORK > WLAN > Port Roles

The following table describes the labels in this screen.

Table 45 NETWORK > WLAN > Port Roles

LABEL	DESCRIPTION
LAN	Select a port's LAN radio button to use the port as part of the LAN. The port will use the LAN IP address.
DMZ	Select a port's DMZ radio button to use the port as part of the DMZ. The port will use the DMZ IP address.
WLAN	Select a port's WLAN radio button to use the port as part of the WLAN. The port will use the WLAN IP address.
Apply	Click Apply to save your changes back to the ZyWALL.
Reset	Click Reset to begin configuring this screen afresh.

After you change the LAN/DMZ/WLAN port roles and click **Apply**, please wait for few seconds until the following screen appears. Click **Return** to go back to the **Port Roles** screen.

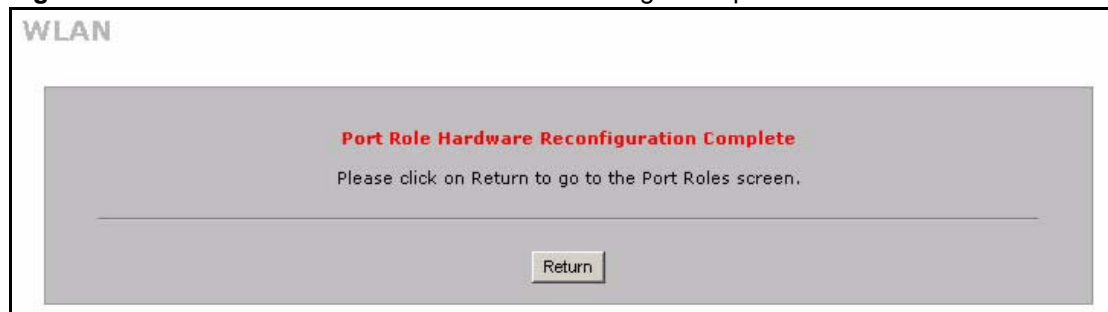
Figure 112 NETWORK > WLAN > Port Roles: Change Complete

PART III

Security

Firewall (181)
Content Filtering Screens (209)
Content Filtering Reports (225)
IPSec VPN (233)
Certificates (273)
Authentication Server (299)

Firewall

This chapter shows you how to configure your ZyWALL's firewall.

11.1 Firewall Overview

The networking term firewall is a system or group of systems that enforces an access-control policy between two networks. It is generally a mechanism used to protect a trusted network from an untrusted network.

The ZyWALL physically separates the LAN, DMZ, WLAN and the WAN and acts as a secure gateway for all data passing between the networks. The ZyWALL protects against Denial of Service (DoS) attacks, prevents theft, destruction and modification of data, and logs events.

Enable the firewall to protect your LAN computers from attacks by hackers on the Internet and control access between the LAN, DMZ, WLAN and WAN. By default the firewall:

- allows traffic that originates from your LAN computers to go to all of the networks.
- blocks traffic that originates on the other networks from going to the LAN.
- allows traffic that originates on the WLAN to go to the WAN.
- allows traffic that originates on the WAN to go to the DMZ and protects your DMZ computers against DoS attacks.
- allows VPN traffic between any of the networks.

The following figure illustrates the default firewall action. User A can initiate an IM (Instant Messaging) session from the LAN to the WAN (1). Return traffic for this session is also allowed (2). However other traffic initiated from the WAN is blocked (3 and 4).

Figure 113 Default Firewall Action

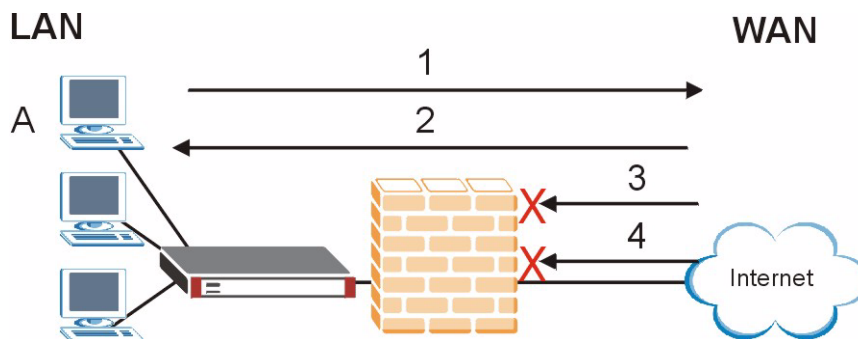

Your customized rules take precedence and override the ZyWALL’s default settings. The ZyWALL checks the source IP address, destination IP address and IP protocol type of network traffic against the firewall rules (in the order you list them). When the traffic matches a rule, the ZyWALL takes the action specified in the rule.

11.2 Packet Direction Matrix

The ZyWALL’s packet direction matrix allows you to apply certain security settings (like firewall) to traffic flowing in specific directions.

For example, click **SECURITY > FIREWALL** to open the following screen. This screen configures general firewall settings.

Figure 114 SECURITY > FIREWALL > Default Rule (Router Mode)

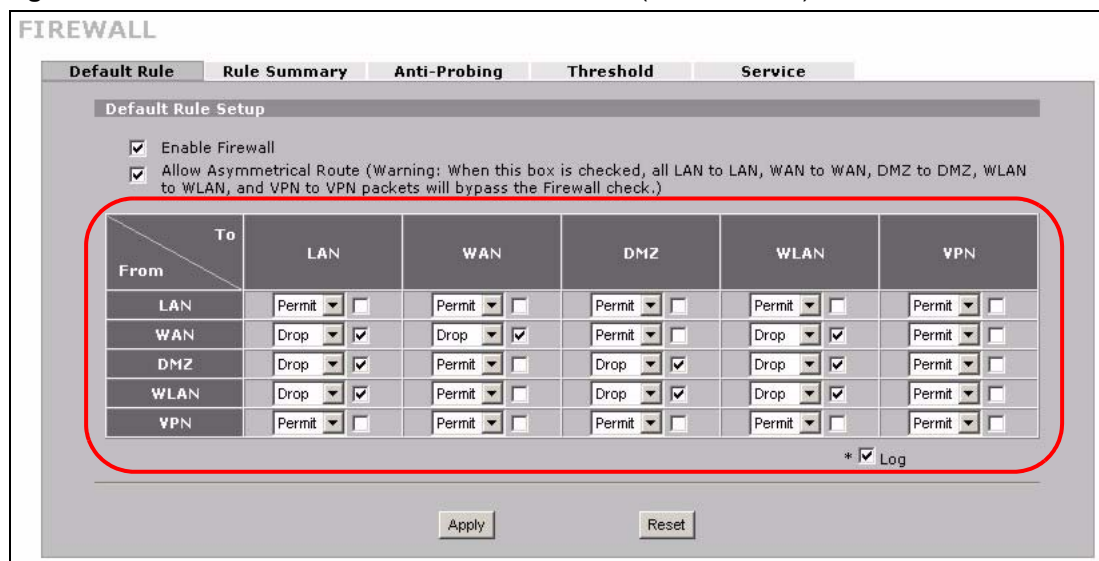

Packets have a source and a destination. The packet direction matrix in the lower part of the screen sets what the ZyWALL does with packets traveling in a specific direction that do not match any of the firewall rules.

Table 46

From		To
A specific interface or any of the ZyWALL’s VPN connections		A specific interface or any of the ZyWALL’s VPN connections

To set the ZyWALL to by default silently block traffic from the WAN from going to the DMZ interfaces, you would find where the **From WAN** row and the **To DMZ** column intersect and set the field to **Drop** as shown.

Figure 115 Default Block Traffic From WAN to DMZ Example

FIREWALL

Default Rule Rule Summary Anti-Probing Threshold Service

Default Rule Setup

Enable Firewall
 Allow Asymmetrical Route (Warning: When this box is checked, all LAN to LAN, WAN to WAN, DMZ to DMZ, WLAN to WLAN, and VPN to VPN packets will bypass the Firewall check.)

From \ To	LAN	WAN	DMZ	WLAN	VPN
LAN	Permit <input type="checkbox"/>	Permit <input type="checkbox"/>	Permit <input type="checkbox"/>	Permit <input type="checkbox"/>	Permit <input type="checkbox"/>
WAN	Drop <input checked="" type="checkbox"/>	Drop <input checked="" type="checkbox"/>	Drop <input checked="" type="checkbox"/>	Drop <input checked="" type="checkbox"/>	Permit <input type="checkbox"/>
DMZ	Drop <input checked="" type="checkbox"/>	Permit <input type="checkbox"/>	Drop <input checked="" type="checkbox"/>	Drop <input checked="" type="checkbox"/>	Permit <input type="checkbox"/>
WLAN	Drop <input checked="" type="checkbox"/>	Permit <input type="checkbox"/>	Drop <input checked="" type="checkbox"/>	Drop <input checked="" type="checkbox"/>	Permit <input type="checkbox"/>
VPN	Permit <input type="checkbox"/>	Permit <input type="checkbox"/>	Permit <input type="checkbox"/>	Permit <input type="checkbox"/>	Permit <input type="checkbox"/>

* Log

Apply Reset

11.3 Packet Direction Examples

Firewall rules are grouped based on the direction of travel of packets to which they apply. This section gives some examples of why you might configure firewall rules for specific connection directions.

By default, the ZyWALL allows packets traveling in the following directions.:

- LAN to LAN These rules specify which computers on the LAN can manage the ZyWALL (remote management) and communicate between networks or subnets connected to the LAN interface (IP alias).

Note: You can also configure the remote management settings to allow only a specific computer to manage the ZyWALL.

- LAN to WAN These rules specify which computers on the LAN can access which computers or services connected to the WAN. See [Section 11.5 on page 188](#) for an example.

By default, the ZyWALL drops packets traveling in the following directions.

- **WAN to LAN** These rules specify which computers connected to the WAN can access which computers or services on the LAN. For example, you may create rules to:
 - Allow certain types of traffic, such as Lotus Notes database synchronization, from specific hosts on the Internet to specific hosts on the LAN.
 - Allow public access to a Web server on your protected network. You could also block certain IP addresses from accessing it.

Note: You also need to configure NAT port forwarding (or full featured NAT address mapping rules) to allow computers on the WAN to access devices on the LAN. See [Section 17.5.3 on page 316](#) for an example.

- **WAN to WAN** By default the ZyWALL stops computers connected to the WAN from managing the ZyWALL or using the ZyWALL as a gateway to communicate with other computers on the WAN. You could configure one of these rules to allow a WAN computer to manage the ZyWALL.

Note: You also need to configure the remote management settings to allow a WAN computer to manage the ZyWALL.

See [Chapter 4 on page 85](#) for information about packets traveling to or from the VPN tunnels.

11.3.1 To VPN Packet Direction

The ZyWALL can apply firewall rules to traffic before encrypting it to send through a VPN tunnel. **To VPN** means traffic that comes in through the selected “from” interface and goes out through any of the ZyWALL’s VPN tunnels. For example, **From LAN To VPN** specifies the traffic that is coming from the LAN and going out through any of the ZyWALL’s VPN tunnels.

For example, by default the **From LAN To VPN** default firewall rule allows traffic from the LAN computers to go out through any of the ZyWALL’s VPN tunnels. You could configure the **From DMZ To VPN** default rule to set the ZyWALL to silently block traffic from the DMZ computers from going out through any of the ZyWALL’s VPN tunnels.

Figure 116 From LAN to VPN Example

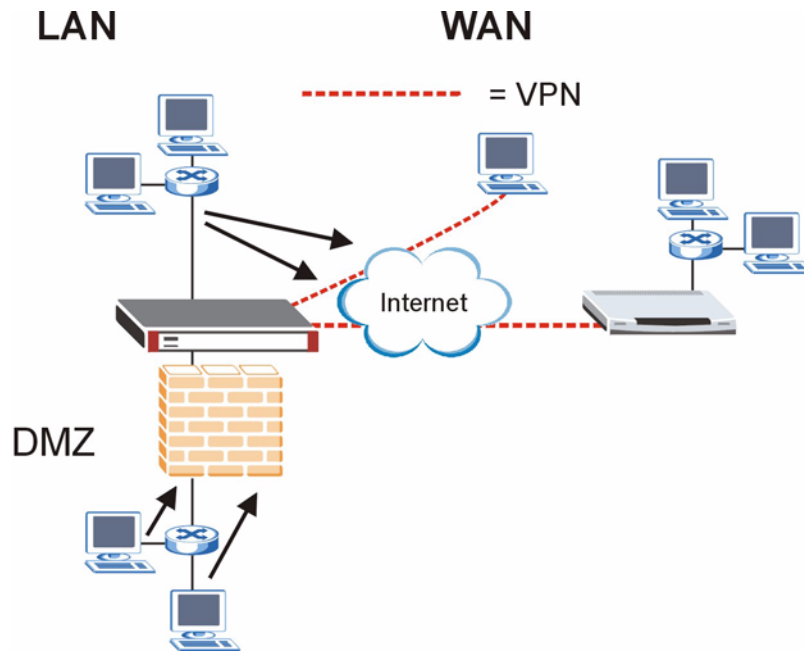

In order to do this, you would configure the **SECURITY > FIREWALL > Default Rule** screen as follows.

Figure 117 Block DMZ to VPN Traffic by Default Example

FIREWALL

Default Rule Rule Summary Anti-Probing Threshold Service

Default Rule Setup

Enable Firewall

Allow Asymmetrical Route (Warning: When this box is checked, all LAN to LAN, WAN to WAN, DMZ to DMZ, WLAN to WLAN, and VPN to VPN packets will bypass the Firewall check.)

From \ To	LAN	WAN	DMZ	WLAN	VPN
LAN	Permit <input type="checkbox"/>	Permit <input type="checkbox"/>	Permit <input type="checkbox"/>	Permit <input type="checkbox"/>	Permit <input type="checkbox"/>
WAN	Drop <input checked="" type="checkbox"/>	Drop <input checked="" type="checkbox"/>	Permit <input type="checkbox"/>	Drop <input checked="" type="checkbox"/>	Permit <input type="checkbox"/>
DMZ	Drop <input checked="" type="checkbox"/>	Permit <input type="checkbox"/>	Drop <input checked="" type="checkbox"/>	Drop <input checked="" type="checkbox"/>	Drop <input checked="" type="checkbox"/>
WLAN	Drop <input checked="" type="checkbox"/>	Permit <input type="checkbox"/>	Drop <input checked="" type="checkbox"/>	Drop <input checked="" type="checkbox"/>	Permit <input type="checkbox"/>
VPN	Permit <input type="checkbox"/>	Permit <input type="checkbox"/>	Permit <input type="checkbox"/>	Permit <input type="checkbox"/>	Permit <input type="checkbox"/>

* Log

Apply Reset

11.3.2 From VPN Packet Direction

You can also apply firewall rules to traffic that comes in through the ZyWALL's VPN tunnels. The ZyWALL decrypts the VPN traffic and then applies the firewall rules. **From VPN** means traffic that came into the ZyWALL through a VPN tunnel and is going to the selected "to" interface.

For example, by default the firewall allows traffic from any VPN tunnel to go to any of the ZyWALL's interfaces, the ZyWALL itself and other VPN tunnels. You could edit the **From VPN To LAN** default firewall rule to silently block traffic from the VPN tunnels from going to the LAN computers.

Figure 118 From VPN to LAN Example

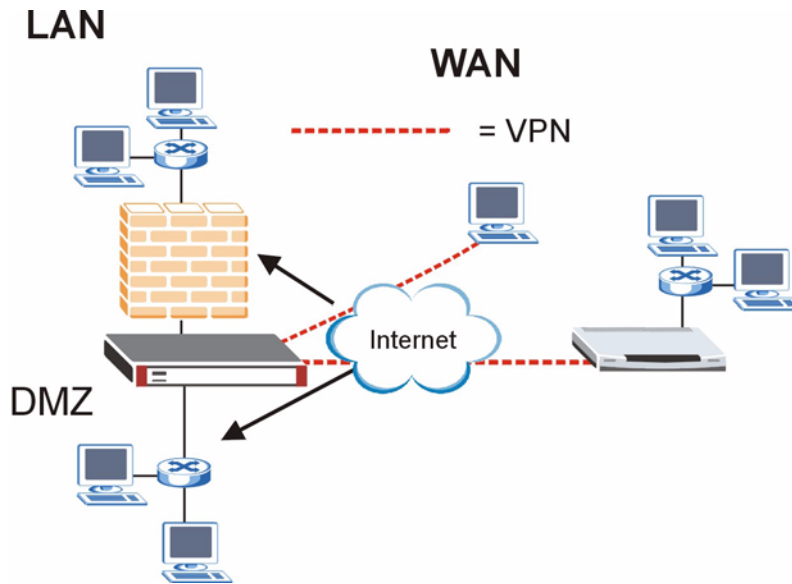

In order to do this, you would configure the **SECURITY > FIREWALL > Default Rule** screen as follows.

Figure 119 Block VPN to LAN Traffic by Default Example

FIREWALL

Default Rule Rule Summary Anti-Probing Threshold Service

Default Rule Setup

- Enable Firewall
- Allow Asymmetrical Route (Warning: When this box is checked, all LAN to LAN, WAN to WAN, DMZ to DMZ, WLAN to WLAN, and VPN to VPN packets will bypass the Firewall check.)

From \ To	LAN	WAN	DMZ	WLAN	VPN
LAN	Permit <input type="checkbox"/>	Permit <input type="checkbox"/>	Permit <input type="checkbox"/>	Permit <input type="checkbox"/>	Permit <input type="checkbox"/>
WAN	Drop <input checked="" type="checkbox"/>	Drop <input checked="" type="checkbox"/>	Permit <input type="checkbox"/>	Drop <input checked="" type="checkbox"/>	Permit <input type="checkbox"/>
DMZ	Drop <input checked="" type="checkbox"/>	Permit <input type="checkbox"/>	Drop <input checked="" type="checkbox"/>	Drop <input checked="" type="checkbox"/>	Permit <input type="checkbox"/>
WLAN	Drop <input checked="" type="checkbox"/>	Permit <input type="checkbox"/>	Drop <input checked="" type="checkbox"/>	Drop <input checked="" type="checkbox"/>	Permit <input type="checkbox"/>
VPN	Drop <input checked="" type="checkbox"/>	Permit <input type="checkbox"/>	Permit <input type="checkbox"/>	Permit <input type="checkbox"/>	Permit <input type="checkbox"/>

* Log

Apply Reset

11.3.3 From VPN To VPN Packet Direction

From VPN To VPN firewall rules apply to traffic that comes in through one of the ZyWALL's VPN tunnels and terminates at the ZyWALL (like for remote management) or goes out through another of the ZyWALL's VPN tunnels (this is called hub-and-spoke VPN, see [Section 14.17 on page 268](#) for details). The ZyWALL decrypts the traffic and applies the firewall rules before re-encrypting it or allowing the traffic to terminate at the ZyWALL.

In the following example, the **From VPN To VPN** default firewall rule silently blocks the traffic that the ZyWALL receives from any VPN tunnel (either A or B) that is destined for the other VPN tunnel or the ZyWALL itself. VPN traffic destined for the DMZ is allowed through.

Figure 120 From VPN to VPN Example

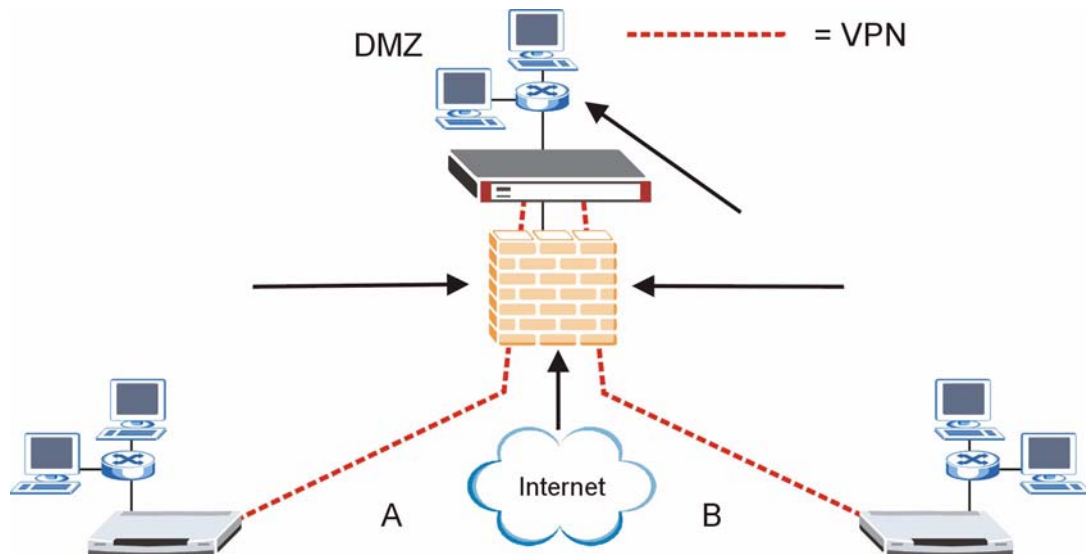

You would configure the **SECURITY > FIREWALL > Default Rule** screen as follows.

Figure 121 Block VPN to VPN Traffic by Default Example

FIREWALL

Default Rule Rule Summary Anti-Probing Threshold Service

Default Rule Setup

Enable Firewall

Allow Asymmetrical Route (Warning: When this box is checked, all LAN to LAN, WAN to WAN, DMZ to DMZ, WLAN to WLAN, and VPN to VPN packets will bypass the Firewall check.)

From \ To	LAN	WAN	DMZ	WLAN	VPN
LAN	Permit <input type="checkbox"/>	Permit <input type="checkbox"/>	Permit <input type="checkbox"/>	Permit <input type="checkbox"/>	Permit <input type="checkbox"/>
WAN	Drop <input checked="" type="checkbox"/>	Drop <input checked="" type="checkbox"/>	Permit <input type="checkbox"/>	Drop <input checked="" type="checkbox"/>	Permit <input type="checkbox"/>
DMZ	Drop <input checked="" type="checkbox"/>	Permit <input type="checkbox"/>	Drop <input checked="" type="checkbox"/>	Drop <input checked="" type="checkbox"/>	Permit <input type="checkbox"/>
WLAN	Drop <input checked="" type="checkbox"/>	Permit <input type="checkbox"/>	Drop <input checked="" type="checkbox"/>	Drop <input checked="" type="checkbox"/>	Permit <input type="checkbox"/>
VPN	Permit <input type="checkbox"/>	Permit <input type="checkbox"/>	Permit <input type="checkbox"/>	Permit <input type="checkbox"/>	Drop <input checked="" type="checkbox"/>

* Log

Apply Reset

11.4 Security Considerations



Incorrectly configuring the firewall may block valid access or introduce security risks to the ZyWALL and your protected network. Use caution when creating or deleting firewall rules and test your rules after you configure them.

Consider these security ramifications before creating a rule:

- 1 Does this rule stop LAN users from accessing critical resources on the Internet? For example, if IRC is blocked, are there users that require this service?
- 2 Is it possible to modify the rule to be more specific? For example, if IRC is blocked for all users, will a rule that blocks just certain users be more effective?
- 3 Does a rule that allows Internet users access to resources on the LAN create a security vulnerability? For example, if FTP ports (TCP 20, 21) are allowed from the Internet to the LAN, Internet users may be able to connect to computers with running FTP servers.
- 4 Does this rule conflict with any existing rules?

Once these questions have been answered, adding rules is simply a matter of entering the information into the correct fields in the web configurator screens.

11.5 Firewall Rules Example

Suppose that your company decides to block all of the LAN users from using IRC (Internet Relay Chat) through the Internet. To do this, you would configure a LAN to WAN firewall rule that blocks IRC traffic from any source IP address from going to any destination address. You do not need to specify a schedule since you need the firewall rule to always be in effect. The following figure shows the results of this rule.

Figure 122 Blocking All LAN to WAN IRC Traffic Example

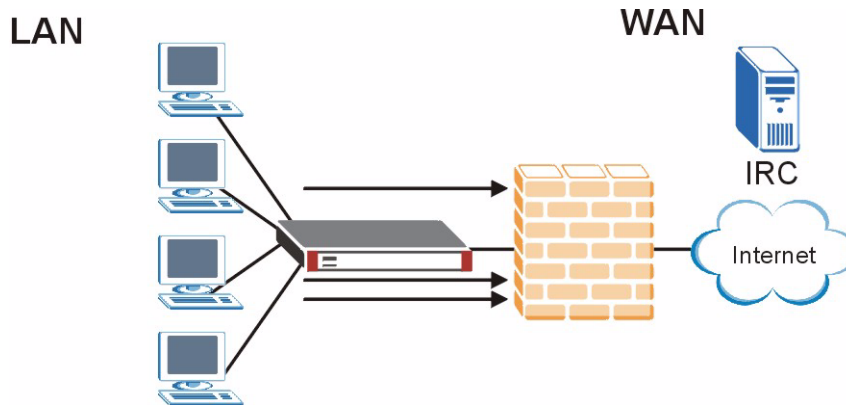

Your firewall would have the following configuration.

Table 47 Blocking All LAN to WAN IRC Traffic Example

#	SOURCE	DESTINATION	SCHEDULE	SERVICE	ACTION
1	Any	Any	Any	IRC	Drop
Default	Any	Any	Any	Any	Allow

- The first row blocks LAN access to the IRC service on the WAN.
- The second row is the firewall's default policy that allows all traffic from the LAN to go to the WAN.

The ZyWALL applies the firewall rules in order. So for this example, when the ZyWALL receives traffic from the LAN, it checks it against the first rule. If the traffic matches (if it is IRC traffic) the firewall takes the action in the rule (drop) and stops checking the firewall rules. Any traffic that does not match the first firewall rule will match the default rule and the ZyWALL forwards it.

Now suppose that your company wants to let the CEO use IRC. You can configure a LAN to WAN firewall rule that allows IRC traffic from the IP address of the CEO's computer. In order to make sure that the CEO's computer always uses the same IP address, make sure it either:

- has a static IP address,
- or you configure a static DHCP entry for it so the ZyWALL always assigns it the same IP address (see [Section 6.8 on page 129](#) for information on static DHCP).

Now you configure a LAN to WAN firewall rule that allows IRC traffic from the IP address of the CEO's computer (192.168.1.7 for example) to go to any destination address. You do not need to specify a schedule since you want the firewall rule to always be in effect. The following figure shows the results of your two custom rules.

Figure 123 Limited LAN to WAN IRC Traffic Example

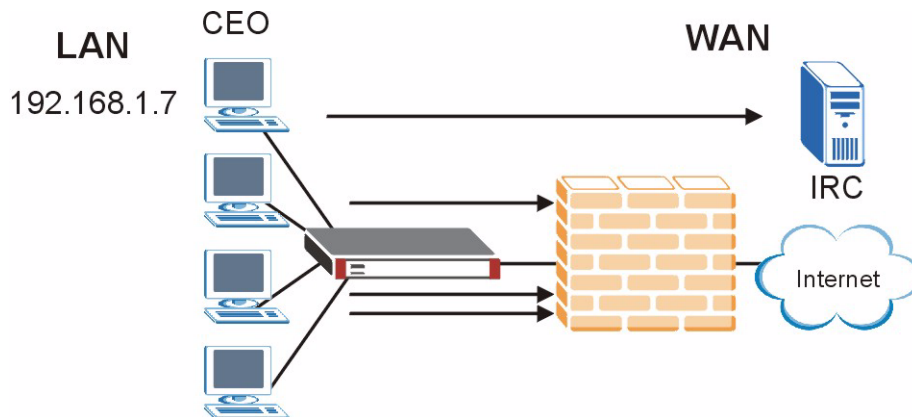

Your firewall would have the following configuration.

Table 48 Limited LAN to WAN IRC Traffic Example

#	SOURCE	DESTINATION	SCHEDULE	SERVICE	ACTION
1	192.168.1.7	Any	Any	IRC	Allow
2	Any	Any	Any	IRC	Drop
Default	Any	Any	Any	Any	Allow

- The first row allows the LAN computer at IP address 192.168.1.7 to access the IRC service on the WAN.
- The second row blocks LAN access to the IRC service on the WAN.
- The third row is (still) the firewall's default policy of allowing all traffic from the LAN to go to the WAN.

The rule for the CEO must come before the rule that blocks all LAN to WAN IRC traffic. If the rule that blocks all LAN to WAN IRC traffic came first, the CEO's IRC traffic would match that rule and the ZyWALL would drop it and not check any other firewall rules.

11.6 Asymmetrical Routes

If an alternate gateway on the LAN has an IP address in the same subnet as the ZyWALL's LAN IP address, return traffic may not go through the ZyWALL. This is called an asymmetrical or "triangle" route. This causes the ZyWALL to reset the connection, as the connection has not been acknowledged.

You can have the ZyWALL permit the use of asymmetrical route topology on the network (not reset the connection).

Allowing asymmetrical routes may let traffic from the WAN go directly to the LAN without passing through the ZyWALL. A better solution is to use IP alias to put the ZyWALL and the backup gateway on separate subnets.

11.6.1 Asymmetrical Routes and IP Alias

You can use IP alias instead of allowing asymmetrical routes. IP Alias allow you to partition your network into logical sections over the same interface.

By putting your LAN and Gateway **A** in different subnets, all returning network traffic must pass through the ZyWALL to your LAN. The following steps describe such a scenario.

- 1** A computer on the LAN initiates a connection by sending a SYN packet to a receiving server on the WAN.
- 2** The ZyWALL reroutes the packet to Gateway **A**, which is in **Subnet 2**.
- 3** The reply from the WAN goes to the ZyWALL.
- 4** The ZyWALL then sends it to the computer on the LAN in **Subnet 1**.

Figure 124 Using IP Alias to Solve the Triangle Route Problem

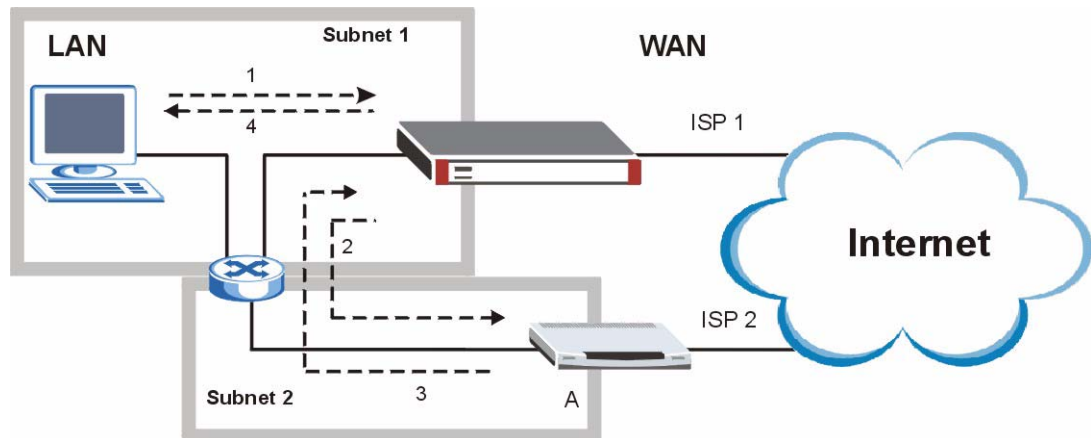

11.7 Firewall Default Rule (Router Mode)

Click **SECURITY > FIREWALL** to open the **Default Rule** screen.

Use this screen to configure general firewall settings when the ZyWALL is set to router mode.

Figure 125 SECURITY > FIREWALL > Default Rule (Router Mode)

FIREWALL

Default Rule | Rule Summary | Anti-Probing | Threshold | Service

Default Rule Setup

- Enable Firewall
- Allow Asymmetrical Route (Warning: When this box is checked, all LAN to LAN, WAN to WAN, DMZ to DMZ, WLAN to WLAN, and VPN to VPN packets will bypass the Firewall check.)

From \ To	LAN	WAN	DMZ	WLAN	VPN
LAN	Permit <input type="checkbox"/>	Permit <input type="checkbox"/>	Permit <input type="checkbox"/>	Permit <input type="checkbox"/>	Permit <input type="checkbox"/>
WAN	Drop <input checked="" type="checkbox"/>	Drop <input checked="" type="checkbox"/>	Permit <input type="checkbox"/>	Drop <input checked="" type="checkbox"/>	Permit <input type="checkbox"/>
DMZ	Drop <input checked="" type="checkbox"/>	Permit <input type="checkbox"/>	Drop <input checked="" type="checkbox"/>	Drop <input checked="" type="checkbox"/>	Permit <input type="checkbox"/>
WLAN	Drop <input checked="" type="checkbox"/>	Permit <input type="checkbox"/>	Drop <input checked="" type="checkbox"/>	Drop <input checked="" type="checkbox"/>	Permit <input type="checkbox"/>
VPN	Permit <input type="checkbox"/>	Permit <input type="checkbox"/>	Permit <input type="checkbox"/>	Permit <input type="checkbox"/>	Permit <input type="checkbox"/>

* Log

Apply Reset

The following table describes the labels in this screen.

Table 49 SECURITY > FIREWALL > Default Rule (Router Mode)

LABEL	DESCRIPTION
Enable Firewall	Select this check box to activate the firewall. The ZyWALL performs access control and protects against Denial of Service (DoS) attacks when the firewall is activated.
Allow Asymmetrical Route	<p>If an alternate gateway on the LAN has an IP address in the same subnet as the ZyWALL's LAN IP address, return traffic may not go through the ZyWALL. This is called an asymmetrical or "triangle" route. This causes the ZyWALL to reset the connection, as the connection has not been acknowledged.</p> <p>Select this check box to have the ZyWALL permit the use of asymmetrical route topology on the network (not reset the connection).</p> <p>Note: Allowing asymmetrical routes may let traffic from the WAN go directly to the LAN without passing through the ZyWALL. A better solution is to use IP alias to put the ZyWALL and the backup gateway on separate subnets. See Section 11.6.1 on page 190 for an example.</p>
From, To	<p>Set the firewall's default actions based on the direction of travel of packets. Here are some example descriptions of the directions of travel.</p> <p>From LAN To LAN means packets traveling from a computer on one LAN subnet to a computer on another LAN subnet on the LAN interface of the ZyWALL or the ZyWALL itself. The ZyWALL does not apply the firewall to packets traveling from a LAN computer to another LAN computer on the same subnet.</p> <p>From VPN means traffic that came into the ZyWALL through a VPN tunnel and is going to the selected "to" interface. For example, From VPN To LAN specifies the VPN traffic that is going to the LAN. The ZyWALL applies the firewall to the traffic after decrypting it.</p> <p>To VPN is traffic that comes in through the selected "from" interface and goes out through any VPN tunnel. For example, From LAN To VPN specifies the traffic that is coming from the LAN and going out through a VPN tunnel. The ZyWALL applies the firewall to the traffic before encrypting it.</p> <p>From VPN To VPN means traffic that comes in through a VPN tunnel and goes out through (another) VPN tunnel or terminates at the ZyWALL. This is the case when the ZyWALL is the hub in a hub-and-spoke VPN. This is also the case if you allow someone to use a service (like Telnet or HTTP) through a VPN tunnel to manage the ZyWALL. The ZyWALL applies the firewall to the traffic after decrypting it.</p> <p>Note: The VPN connection directions apply to the traffic going to or from the ZyWALL's VPN tunnels. They do not apply to other VPN traffic for which the ZyWALL is not one of the gateways (VPN pass-through traffic).</p> <p>Here are the default actions from which you can select.</p> <p>Select Drop to silently discard the packets without sending a TCP reset packet or an ICMP destination-unreachable message to the sender.</p> <p>Select Reject to deny the packets and send a TCP reset packet (for a TCP packet) or an ICMP destination-unreachable message (for a UDP packet) to the sender.</p> <p>Select Permit to allow the passage of the packets.</p> <p>The firewall rules for the WAN port with a higher route priority also apply to the dial backup connection.</p>
Log	Select the check box next to a direction of packet travel to create a log when the above action is taken for packets that are traveling in that direction and do not match any of your customized rules.

Table 49 SECURITY > FIREWALL > Default Rule (Router Mode) (continued)

LABEL	DESCRIPTION
Apply	Click Apply to save your changes back to the ZyWALL.
Reset	Click Reset to begin configuring this screen afresh.

11.8 Firewall Default Rule (Bridge Mode)

Click **SECURITY > FIREWALL** to open the **Default Rule** screen.

Use this screen to configure general firewall settings when the ZyWALL is set to bridge mode.

Figure 126 SECURITY > FIREWALL > Default Rule (Bridge Mode)

FIREWALL

Default Rule | Rule Summary | Anti-Probing | Threshold | Service

Default Rule Setup

Enable Firewall

From \ To	LAN	WAN	DMZ	WLAN	VPN
LAN	Permit <input type="checkbox"/> <input type="checkbox"/>	Permit <input type="checkbox"/> <input type="checkbox"/>	Permit <input type="checkbox"/> <input type="checkbox"/>	Permit <input type="checkbox"/> <input type="checkbox"/>	Permit <input type="checkbox"/> <input type="checkbox"/>
WAN	Drop <input checked="" type="checkbox"/> <input checked="" type="checkbox"/>	Drop <input checked="" type="checkbox"/> <input checked="" type="checkbox"/>	Permit <input type="checkbox"/> <input type="checkbox"/>	Drop <input checked="" type="checkbox"/> <input checked="" type="checkbox"/>	Permit <input type="checkbox"/> <input type="checkbox"/>
DMZ	Drop <input checked="" type="checkbox"/> <input checked="" type="checkbox"/>	Permit <input type="checkbox"/> <input type="checkbox"/>	Drop <input checked="" type="checkbox"/> <input checked="" type="checkbox"/>	Drop <input checked="" type="checkbox"/> <input checked="" type="checkbox"/>	Permit <input type="checkbox"/> <input type="checkbox"/>
WLAN	Drop <input checked="" type="checkbox"/> <input checked="" type="checkbox"/>	Permit <input type="checkbox"/> <input type="checkbox"/>	Drop <input checked="" type="checkbox"/> <input checked="" type="checkbox"/>	Drop <input checked="" type="checkbox"/> <input checked="" type="checkbox"/>	Permit <input type="checkbox"/> <input type="checkbox"/>
VPN	Permit <input type="checkbox"/> <input type="checkbox"/>	Permit <input type="checkbox"/> <input type="checkbox"/>	Permit <input type="checkbox"/> <input type="checkbox"/>	Permit <input type="checkbox"/> <input type="checkbox"/>	Permit <input type="checkbox"/> <input type="checkbox"/>

* Log
 * Log Broadcast Frame

Apply Reset

The following table describes the labels in this screen.

Table 50 SECURITY > FIREWALL > Default Rule (Bridge Mode)

LABEL	DESCRIPTION
Enable Firewall	Select this check box to activate the firewall. The ZyWALL performs access control and protects against Denial of Service (DoS) attacks when the firewall is activated.
From, To	<p>Set the firewall's default actions based on the direction of travel of packets. Here are some example descriptions of the directions of travel.</p> <p>From LAN To LAN means packets traveling from a computer on one LAN subnet to a computer on another LAN subnet on the LAN interface of the ZyWALL or the ZyWALL itself. The ZyWALL does not apply the firewall to packets traveling from a LAN computer to another LAN computer on the same subnet.</p> <p>From VPN means traffic that came into the ZyWALL through a VPN tunnel and is going to the selected "to" interface. For example, From VPN To LAN specifies the VPN traffic that is going to the LAN. The ZyWALL applies the firewall to the traffic after decrypting it.</p> <p>To VPN is traffic that comes in through the selected "from" interface and goes out through any VPN tunnel. For example, From LAN To VPN specifies the traffic that is coming from the LAN and going out through a VPN tunnel. The ZyWALL applies the firewall to the traffic before encrypting it.</p> <p>From VPN To VPN means traffic that comes in through a VPN tunnel and goes out through (another) VPN tunnel or terminates at the ZyWALL. This is the case when the ZyWALL is the hub in a hub-and-spoke VPN. This is also the case if you allow someone to use a service (like Telnet or HTTP) through a VPN tunnel to manage the ZyWALL. The ZyWALL applies the firewall to the traffic after decrypting it.</p> <p>Note: The VPN connection directions apply to the traffic going to or from the ZyWALL's VPN tunnels. They do not apply to other VPN traffic for which the ZyWALL is not one of the gateways (VPN pass-through traffic).</p> <p>Here are the default actions from which you can select.</p> <p>Select Drop to silently discard the packets without sending a TCP reset packet or an ICMP destination-unreachable message to the sender.</p> <p>Select Reject to deny the packets and send a TCP reset packet (for a TCP packet) or an ICMP destination-unreachable message (for a UDP packet) to the sender.</p> <p>Select Permit to allow the passage of the packets.</p>
Log	Select this to create a log when the above action is taken.
Log Broadcast Frame	Select this to create a log for any broadcast frames traveling in the selected direction. Many of these logs in a short time period could indicate a broadcast storm. A broadcast storm occurs when a packet triggers multiple responses from all hosts on a network or when computers attempt to respond to a host that never replies. As a result, duplicated packets are continuously created and circulated in the network, thus reducing network performance or even rendering it inoperable. A broadcast storm can be caused by an attack on the network, an incorrect network topology (such as a bridge loop) or a malfunctioning network device.
Apply	Click Apply to save your changes back to the ZyWALL.
Reset	Click Reset to begin configuring this screen afresh.

11.9 Firewall Rule Summary

Click **SECURITY > FIREWALL > Rule Summary** to open the screen. This screen displays a list of the configured firewall rules.



The ordering of your rules is very important as rules are applied in the order that they are listed.

- When the ZyWALL is in bridge mode, enable the default **WAN to LAN** firewall rule for the **BOOTP_CLIENT** service to let DHCP clients behind the ZyWALL use a DHCP server on the WAN.
- Enable the default **WAN to LAN** firewall rule for the **NetBIOS** service to let computers behind the ZyWALL access devices on the WAN using computer names.

Figure 127 SECURITY > FIREWALL > Rule Summary

The following table describes the labels in this screen.

Table 51 SECURITY > FIREWALL > Rule Summary

LABEL	DESCRIPTION
Firewall Rules Storage Space in Use	This bar displays the percentage of the ZyWALL's firewall rules storage space that is currently in use. The bar turns from green to red when the maximum is being approached. When the bar is red, you should consider deleting unnecessary firewall rules before adding more firewall rules.
Packet Direction	Use the drop-down list box to select a direction of travel of packets for which you want to configure firewall rules. Note: The VPN connection directions apply to the traffic going to or from the ZyWALL's VPN tunnels. They do not apply to other VPN traffic for which the ZyWALL is not one of the gateways (VPN pass-through traffic).
Default Policy	This field displays the default action and log policy you selected in the Default Rule screen for the packet direction shown in the field above.
The following read-only fields summarize the rules you have created that apply to traffic traveling in the selected packet direction. The firewall rules that you configure (summarized below) take priority over the general firewall action settings above.	
#	This is your firewall rule number. The ordering of your rules is important as rules are applied in turn. Click + to expand or - to collapse the Source Address , Destination Address and Service Type drop down lists.

Table 51 SECURITY > FIREWALL > Rule Summary

LABEL	DESCRIPTION
Name	This is the name of the firewall rule.
Active	This field displays whether a firewall is turned on (Y) or not (N).
Source Address	This drop-down list box displays the source addresses or ranges of addresses to which this firewall rule applies. Please note that a blank source or destination address is equivalent to Any .
Destination Address	This drop-down list box displays the destination addresses or ranges of addresses to which this firewall rule applies. Please note that a blank source or destination address is equivalent to Any .
Service Type	This drop-down list box displays the services to which this firewall rule applies. See Appendix E on page 615 for a list of common services.
Action	This field displays whether the firewall silently discards packets (Drop), discards packets and sends a TCP reset packet or an ICMP destination-unreachable message to the sender (Reject) or allows the passage of packets (Permit).
Sch.	This field tells you whether a schedule is specified (Yes) or not (No).
Log	This field shows you whether a log is created when packets match this rule (Yes) or not (No).
Modify	Click the edit icon to go to the screen where you can edit the rule. Click the delete icon to delete an existing firewall rule. A window display asking you to confirm that you want to delete the firewall rule. Note that subsequent firewall rules move up by one when you take this action.
Insert	Type the index number for where you want to put a rule. For example, if you type 6, your new rule becomes number 6 and the previous rule 6 (if there is one) becomes rule 7. Click Insert to display this screen and refer to the following table for information on the fields.
Move	Type a rule's index number and the number for where you want to put that rule. Click Move to move the rule to the number that you typed. The ordering of your rules is important as they are applied in order of their numbering.

11.9.1 Firewall Edit Rule

Follow these directions to create a new rule.

- 1 In the **Rule Summary** screen, type the index number for where you want to put the rule. For example, if you type 6, your new rule becomes number 6 and the previous rule 6 (if there is one) becomes rule 7.
- 2 Click **Insert** to display the **Firewall Edit Rule** screen.

Use this screen to create or edit a firewall rule. Refer to the following table for information on the labels.

Figure 128 SECURITY > FIREWALL > Rule Summary > Edit

FIREWALL - EDIT RULE

Rule Name

Edit Source Address

Address Editor

Address Type

Start IP Address

End IP Address

Subnet Mask

Source Address(es)

Edit Destination Address

Address Editor

Address Type

Start IP Address

End IP Address

Subnet Mask

Destination Address(es)

Edit Service

Available Services (See [Service](#))

- *ECHO REPLY(ICMP.Type:0/Code:0)
- *ECHO REQUEST(ICMP.Type:8/Code:0)
- Any(All)
- Any(TCP)
- Any(UDP)
- Any(ICMP)
- AIMNEW_ICQ(TCP:5190)
- AUTH(TCP:113)
- BGP(TCP:179)
- BOOTP_CLIENT(UDP:68)
- BOOTP_SERVER(UDP:67)
- CU-SEEME(TCP/UDP:7648,24032)
- DNS(TCP/UDP:53)
- FINGER(TCP:79)
- FTP(TCP:20,21)

Selected Service(s)

Edit Schedule

Day to Apply:

Sun Mon Tue Wed Thu Fri Sat

Time of Day to Apply: (24-Hour Format)

All day

Start: (Hour) (Minute) End: (Hour) (Minute)

Actions When Matched

Log Packet Information When Matched

Send Alert Message to Administrator When Matched

Action for Matched Packets

The following table describes the labels in this screen.

Table 52 SECURITY > FIREWALL > Rule Summary > Edit

LABEL	DESCRIPTION
Rule Name	Enter a descriptive name of up to 31 printable ASCII characters (except Extended ASCII characters) for the firewall rule. Spaces are allowed.
Edit Source/ Destination Address	
Address Type	Do you want your rule to apply to packets with a particular (single) IP, a range of IP addresses (for example 192.168.1.10 to 192.169.1.50), a subnet or any IP address? Select an option from the drop-down list box that includes: Single Address, Range Address, Subnet Address and Any Address .
Start IP Address	Enter the single IP address or the starting IP address in a range here.
End IP Address	Enter the ending IP address in a range here.
Subnet Mask	Enter the subnet mask here, if applicable.
Add	Click Add to add a new address to the Source or Destination Address(es) box. You can add multiple addresses, ranges of addresses, and/or subnets.
Modify	To edit an existing source or destination address, select it from the box and click Modify .
Delete	Highlight an existing source or destination address from the Source or Destination Address(es) box above and click Delete to remove it.
Edit Service	
Available/ Selected Services	<p>Highlight a service from the Available Services box on the left, then click >> to add it to the Selected Service(s) box on the right. To remove a service, highlight it in the Selected Service(s) box on the right, then click <<.</p> <p>Next to the name of a service, two fields appear in brackets. The first field indicates the IP protocol type (TCP, UDP, or ICMP). The second field indicates the IP port number that defines the service. (Note that there may be more than one IP protocol type). For example, look at the DNS entry, (UDP/TCP:53) means UDP port 53 and TCP port 53. Click the Service link to go to the Service screen where you can configure custom service ports. See Appendix E on page 615 for a list of commonly used services and port numbers.</p> <p>You can use the [CTRL] key and select multiple services at once.</p>
Edit Schedule	
Day to Apply	Select everyday or the day(s) of the week to apply the rule.
Time of Day to Apply (24-Hour Format)	Select All Day or enter the start and end times in the hour-minute format to apply the rule.
Actions When Matched	
Log Packet Information When Matched	This field determines if a log for packets that match the rule is created (Yes) or not (No). Go to the Log Settings page and select the Access Control logs category to have the ZyWALL record these logs.
Send Alert Message to Administrator When Matched	Select the check box to have the ZyWALL generate an alert when the rule is matched.

Table 52 SECURITY > FIREWALL > Rule Summary > Edit

LABEL	DESCRIPTION
Action for Matched Packets	<p>Use the drop-down list box to select what the firewall is to do with packets that match this rule.</p> <p>Select Drop to silently discard the packets without sending a TCP reset packet or an ICMP destination-unreachable message to the sender.</p> <p>Select Reject to deny the packets and send a TCP reset packet (for a TCP packet) or an ICMP destination-unreachable message (for a UDP packet) to the sender.</p> <p>Select Permit to allow the passage of the packets.</p> <p>Note: You also need to configure NAT port forwarding (or full featured NAT address mapping rules) if you want to allow computers on the WAN to access devices on the LAN.</p> <p>Note: You may also need to configure the remote management settings if you want to allow a WAN computer to manage the ZyWALL or restrict management from the LAN.</p>
Apply	Click Apply to save your customized settings and exit this screen.
Cancel	Click Cancel to exit this screen without saving.

11.10 Anti-Probing

Click **SECURITY > FIREWALL > Anti-Probing** to open the following screen. Configure this screen to help keep the ZyWALL hidden from probing attempts. You can specify which of the ZyWALL's interfaces will respond to Ping requests and whether or not the ZyWALL is to respond to probing for unused ports.

Figure 129 SECURITY > FIREWALL > Anti-Probing

The screenshot shows the 'Anti-Probing Setup' configuration page. At the top, there are navigation tabs: 'Default Rule', 'Rule Summary', 'Anti-Probing' (which is selected), 'Threshold', and 'Service'. Below the tabs, the 'Anti-Probing Setup' section is visible. It contains the following options:

- Respond to PING on:** This section has four checked checkboxes: LAN, WAN, DMZ, and WLAN.
- Do not respond to requests for unauthorized services:** This checkbox is currently unchecked.

At the bottom of the configuration area, there are two buttons: 'Apply' and 'Reset'.

The following table describes the labels in this screen.

Table 53 SECURITY > FIREWALL > Anti-Probing

LABEL	DESCRIPTION
Respond to PING on	Select the check boxes of the interfaces that you want to reply to incoming Ping requests. Clear an interface's check box to have the ZyWALL not respond to any Ping requests that come into that interface.
Do not respond to requests for unauthorized services.	Select this option to prevent hackers from finding the ZyWALL by probing for unused ports. If you select this option, the ZyWALL will not respond to port request(s) for unused ports, thus leaving the unused ports and the ZyWALL unseen. If this option is not selected, the ZyWALL will reply with an ICMP port unreachable packet for a port probe on its unused UDP ports and a TCP reset packet for a port probe on its unused TCP ports. Note that the probing packets must first traverse the ZyWALL's firewall rule checks before reaching this anti-probing mechanism. Therefore if a firewall rule stops a probing packet, the ZyWALL reacts based on the firewall rule to either send a TCP reset packet for a blocked TCP packet (or an ICMP port-unreachable packet for a blocked UDP packets) or just drop the packets without sending a response packet.
Apply	Click Apply to save your changes back to the ZyWALL.
Reset	Click Reset to begin configuring this screen afresh.

11.11 Firewall Thresholds

For DoS attacks, the ZyWALL uses thresholds to determine when to start dropping sessions that do not become fully established (half-open sessions). These thresholds apply globally to all sessions.

For TCP, half-open means that the session has not reached the established state-the TCP three-way handshake has not yet been completed. Under normal circumstances, the application that initiates a session sends a SYN (synchronize) packet to the receiving server. The receiver sends back an ACK (acknowledgment) packet and its own SYN, and then the initiator responds with an ACK (acknowledgment). After this handshake, a connection is established.

Figure 130 Three-Way Handshake

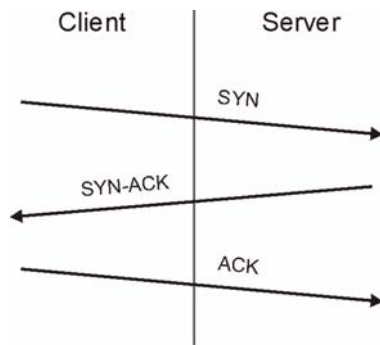

For UDP, half-open means that the firewall has detected no return traffic. An unusually high number (or arrival rate) of half-open sessions could indicate a DOS attack.

11.11.1 Threshold Values

If everything is working properly, you probably do not need to change the threshold settings as the default threshold values should work for most small offices. Tune these parameters when you believe the ZyWALL has been receiving DoS attacks that are not recorded in the logs or the logs show that the ZyWALL is classifying normal traffic as DoS attacks. Factors influencing choices for threshold values are:

- 1 The maximum number of opened sessions.
- 2 The minimum capacity of server backlog in your LAN network.
- 3 The CPU power of servers in your LAN network.
- 4 Network bandwidth.
- 5 Type of traffic for certain servers.

Reduce the threshold values if your network is slower than average for any of these factors (especially if you have servers that are slow or handle many tasks and are often busy).

If you often use P2P applications such as file sharing with eMule or eDonkey, it's recommended that you increase the threshold values since lots of sessions will be established during a small period of time and the ZyWALL may classify them as DoS attacks.

11.12 Threshold Screen

Click **SECURITY > FIREWALL > Threshold** to bring up the next screen. The global values specified for the threshold and timeout apply to all TCP connections.

Figure 131 SECURITY > FIREWALL > Threshold

FIREWALL

Default Rule | Rule Summary | Anti-Probing | **Threshold** | Service

Disable DoS Attack Protection on LAN WAN DMZ WLAN VPN

Denial of Service Thresholds

One Minute Low	<input type="text" value="80"/>	sessions per minute
One Minute High	<input type="text" value="100"/>	sessions per minute
Maximum Incomplete Low	<input type="text" value="80"/>	sessions
Maximum Incomplete High	<input type="text" value="100"/>	sessions
TCP Maximum Incomplete	<input type="text" value="10"/>	sessions

Action taken when TCP Maximum Incomplete reached threshold

Delete the oldest half open session when new connection request comes.

Deny new connection request for (1~255 minutes)

Apply Reset

The following table describes the labels in this screen.

Table 54 SECURITY > FIREWALL > Threshold

LABEL	DESCRIPTION
Disable DoS Attack Protection on	Select the check boxes of any interfaces (or all VPN tunnels) for which you want the ZyWALL to not use the Denial of Service protection thresholds. This disables DoS protection on the selected interface (or all VPN tunnels). You may want to disable DoS protection for an interface if the ZyWALL is treating valid traffic as DoS attacks. Another option would be to raise the thresholds.
Denial of Service Thresholds	The ZyWALL measures both the total number of existing half-open sessions and the rate of session establishment attempts. Both TCP and UDP half-open sessions are counted in the total number and rate measurements. Measurements are made once a minute.
One Minute Low	This is the rate of new half-open sessions per minute that causes the firewall to stop deleting half-open sessions. The ZyWALL continues to delete half-open sessions as necessary, until the rate of new connection attempts drops below this number.
One Minute High	This is the rate of new half-open sessions per minute that causes the firewall to start deleting half-open sessions. When the rate of new connection attempts rises above this number, the ZyWALL deletes half-open sessions as required to accommodate new connection attempts. For example, if you set the one minute high to 100, the ZyWALL starts deleting half-open sessions when more than 100 session establishment attempts have been detected in the last minute. It stops deleting half-open sessions when the number of session establishment attempts detected in a minute goes below the number set as the one minute low.
Maximum Incomplete Low	This is the number of existing half-open sessions that causes the firewall to stop deleting half-open sessions. The ZyWALL continues to delete half-open requests as necessary, until the number of existing half-open sessions drops below this number.
Maximum Incomplete High	This is the number of existing half-open sessions that causes the firewall to start deleting half-open sessions. When the number of existing half-open sessions rises above this number, the ZyWALL deletes half-open sessions as required to accommodate new connection requests. Do not set Maximum Incomplete High to lower than the current Maximum Incomplete Low number. For example, if you set the maximum incomplete high to 100, the ZyWALL starts deleting half-open sessions when the number of existing half-open sessions rises above 100. It stops deleting half-open sessions when the number of existing half-open sessions drops below the number set as the maximum incomplete low.
TCP Maximum Incomplete	An unusually high number of half-open sessions with the same destination host address could indicate that a DoS attack is being launched against the host. Specify the number of existing half-open TCP sessions with the same destination host IP address that causes the firewall to start dropping half-open sessions to that same destination host IP address. Enter a number between 1 and 256. As a general rule, you should choose a smaller number for a smaller network, a slower system or limited bandwidth. The ZyWALL sends alerts whenever the TCP Maximum Incomplete is exceeded.
Action taken when TCP Maximum Incomplete reached threshold	Select the action that ZyWALL should take when the TCP maximum incomplete threshold is reached. You can have the ZyWALL either: Delete the oldest half open session when a new connection request comes. or Deny new connection requests for the number of minutes that you specify (between 1 and 255).
Apply	Click Apply to save your changes back to the ZyWALL.
Reset	Click Reset to begin configuring this screen afresh.

11.13 Service

Click **SECURITY > FIREWALL > Service** to open the screen as shown next. Use this screen to configure custom services for use in firewall rules or view the services that are predefined in the ZyWALL.

Figure 132 SECURITY > FIREWALL > Service

Custom Service

#	Service Name	Protocol	Attribute*	Modify
1	ECHO REPLY	ICMP	0/0	
2	ECHO REQUEST	ICMP	8/0	

*Attribute: Port Range for TCP/UDP, Type/Code for ICMP.

Predefined Service

#	Service Name	Protocol	Attribute
1	Any_All	ALL	-
2	Any_TCP	TCP	1~65535
3	Any_UDP	UDP	1~65535
4	Any_ICMP	ICMP	-
5	AIM/NEW_ICQ	TCP	5190
6	AUTH	TCP	113
7	BGP	TCP	179
8	BOOTP_CLIENT	UDP	68
9	BOOTP_SERVER	UDP	67
10	CDP	UDP	224
11	DHCP	UDP	67
12	DHCP_CLIENT	UDP	68
13	DHCP_SERVER	UDP	67
14	FTP	TCP	21
15	FTP_DATA	TCP	20
16	HTTP	TCP	80
17	HTTPS	TCP	443
18	IM	TCP	5190
19	IM_NEW_ICQ	TCP	5190
20	IRC	TCP	6667
21	IRC_SERVER	TCP	6667
22	ISAKMP	UDP	500
23	ISAKMP_CLIENT	UDP	500
24	ISAKMP_SERVER	UDP	500
25	LDAP	TCP	389
26	LDAP_CLIENT	TCP	389
27	LDAP_SERVER	TCP	389
28	LDAP_UDP	UDP	389
29	LDAP_CLIENT_UDP	UDP	389
30	LDAP_SERVER_UDP	UDP	389
31	NETBIOS	TCP	137
32	NETBIOS_UDP	UDP	137
33	NETBIOS_CLIENT	TCP	137
34	NETBIOS_SERVER	TCP	137
35	NETBIOS_UDP_CLIENT	UDP	137
36	NETBIOS_UDP_SERVER	UDP	137
37	POP3	TCP	110
38	POP3_CLIENT	TCP	110
39	POP3_SERVER	TCP	110
40	POP3_UDP	UDP	110
41	POP3_CLIENT_UDP	UDP	110
42	POP3_SERVER_UDP	UDP	110
43	SFTP	TCP	115
44	SIP-V2	UDP	5060
45	SMTP	TCP	25
46	SNMP	TCP/UDP	161
47	SNMP-TRAPS	TCP/UDP	162
48	SQL-NET	TCP	1521
49	SSDP	UDP	1900
50	SSH	TCP/UDP	22
51	STRMWORKS	UDP	1558
52	SYSLOG	UDP	514
53	TACACS	UDP	49
54	TELNET	TCP	23
55	TFTP	UDP	69
56	VDOLIVE	TCP	7000
57	Microsoft RDP	TCP	3389
58	VNC	TCP	5900
59	NTP	TCP/UDP	123

The following table describes the labels in this screen.

Table 55 SECURITY > FIREWALL > Service

LABEL	DESCRIPTION
Custom Service	This table shows all configured custom services.
#	This is the index number of the custom service.
Service Name	This is the name of the service.
Protocol	This is the IP protocol type. If you selected Custom , this is the IP protocol value you entered.
Attribute	This is the IP port number or ICMP type and code that defines the service.

Table 55 SECURITY > FIREWALL > Service (continued)

LABEL	DESCRIPTION
Modify	Click the edit icon to go to the screen where you can edit the service. Click the delete icon to remove an existing service. A window displays asking you to confirm that you want to delete the service. Note that subsequent services move up by one when you take this action.
Add	Click this button to bring up the screen that you use to configure a new custom service that is not in the predefined list of services.
Predefined Service	This table shows all the services that are already configured for use in firewall rules. See Appendix E on page 615 for a list of common services.
#	This is the index number of the predefined service.
Service Name	This is the name of the service.
Protocol	This is the IP protocol type. There may be more than one IP protocol type.
Attribute	This is the IP port number or ICMP type and code that defines the service.

11.13.1 Firewall Edit Custom Service

Click **SECURITY > FIREWALL > Service > Add** to display the following screen. Use this screen to configure a custom service entry not is not predefined in the ZyWALL. See [Appendix E on page 615](#) for a list of commonly used services and port numbers.

Figure 133 Firewall Edit Custom Service

The following table describes the labels in this screen.

Table 56 SECURITY > FIREWALL > Service > Add

LABEL	DESCRIPTION
Service Name	Enter a descriptive name of up to 31 printable ASCII characters (except Extended ASCII characters) for the custom service. You cannot use the “(” character. Spaces are allowed.
IP Protocol	Choose the IP protocol (TCP , UDP , TCP/UDP , ICMP or Custom) that defines your customized service from the drop down list box. If you select Custom , specify the protocol's number. For example, ICMP is 1, TCP is 6, UDP is 17 and so on.
Port Range	Enter the port number (from 1 to 255) that defines the customized service To specify one port only, enter the port number in the From field and enter it again in the To field. To specify a span of ports, enter the first port in the From field and enter the last port in the To field.

Table 56 SECURITY > FIREWALL > Service > Add (continued)

LABEL	DESCRIPTION
Type/Code	This field is available only when you select ICMP in the IP Protocol field. The ICMP messages are identified by their types and in some cases codes. Enter the type number in the Type field and select the Code radio button and enter the code number if any.
Apply	Click Apply to save your customized settings and exit this screen.
Cancel	Click Cancel to exit this screen without saving.

11.14 My Service Firewall Rule Example

The following Internet firewall rule example allows a hypothetical My Service connection from the Internet.

- 1 In the **Service** screen, click **Add** to open the **Edit Custom Service** screen.

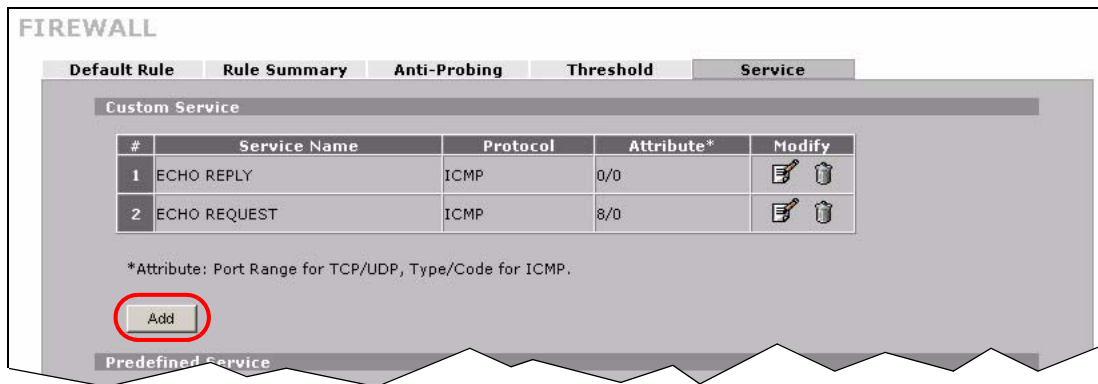
Figure 134 My Service Firewall Rule Example: Service

- 2 Configure it as follows and click **Apply**.

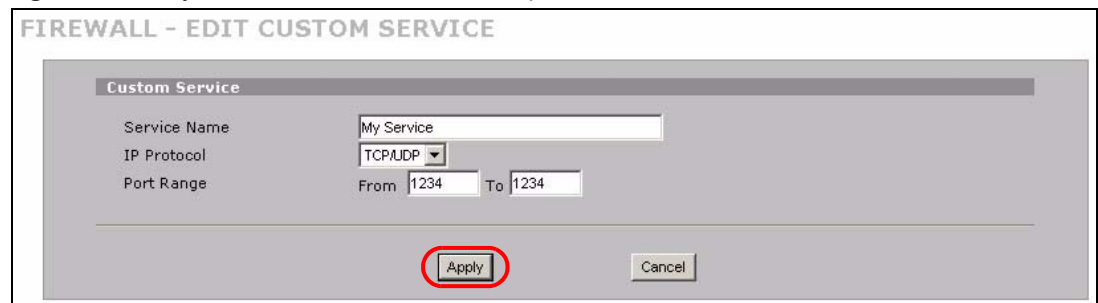
Figure 135 My Service Firewall Rule Example: Edit Custom Service

- 3 Click **Rule Summary**. Select **WAN to LAN** from the **Packet Direction** drop-down list box.
- 4 In the **Rule Summary** screen, type the index number for where you want to put the rule. For example, if you type 6, your new rule becomes number 6 and the previous rule 6 (if there is one) becomes rule 7.
- 5 Click **Insert** to display the firewall rule configuration screen.

Figure 136 My Service Firewall Rule Example: Rule Summary

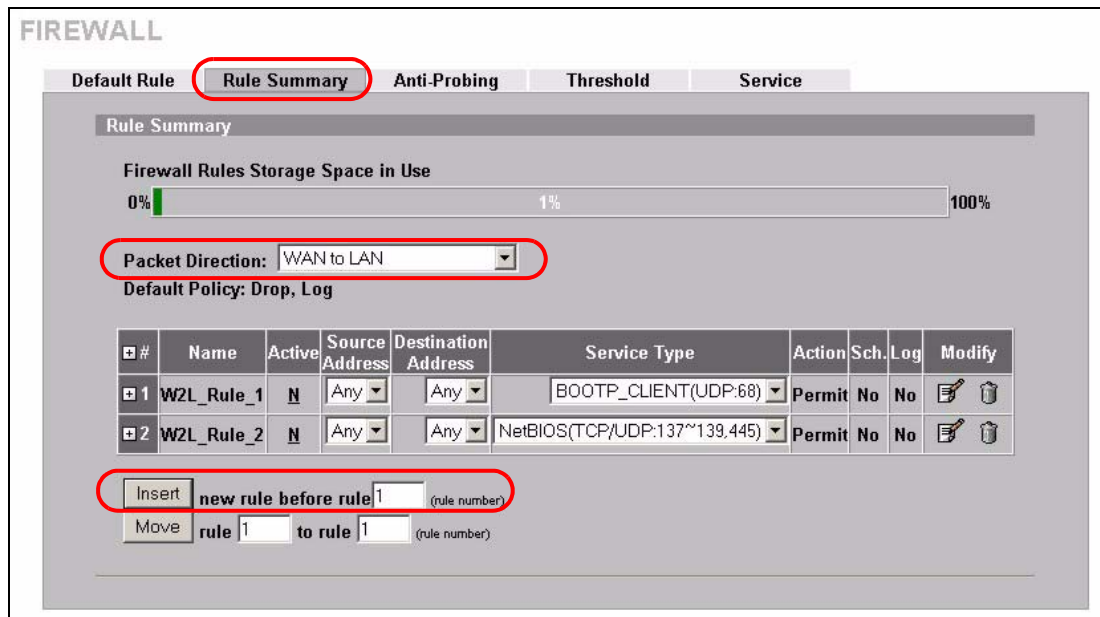

- 6 Enter the name of the firewall rule.
- 7 Select **Any** in the **Destination Address(es)** box and then click **Delete**.
- 8 Configure the destination address fields as follows and click **Add**.

Figure 137 My Service Firewall Rule Example: Rule Edit

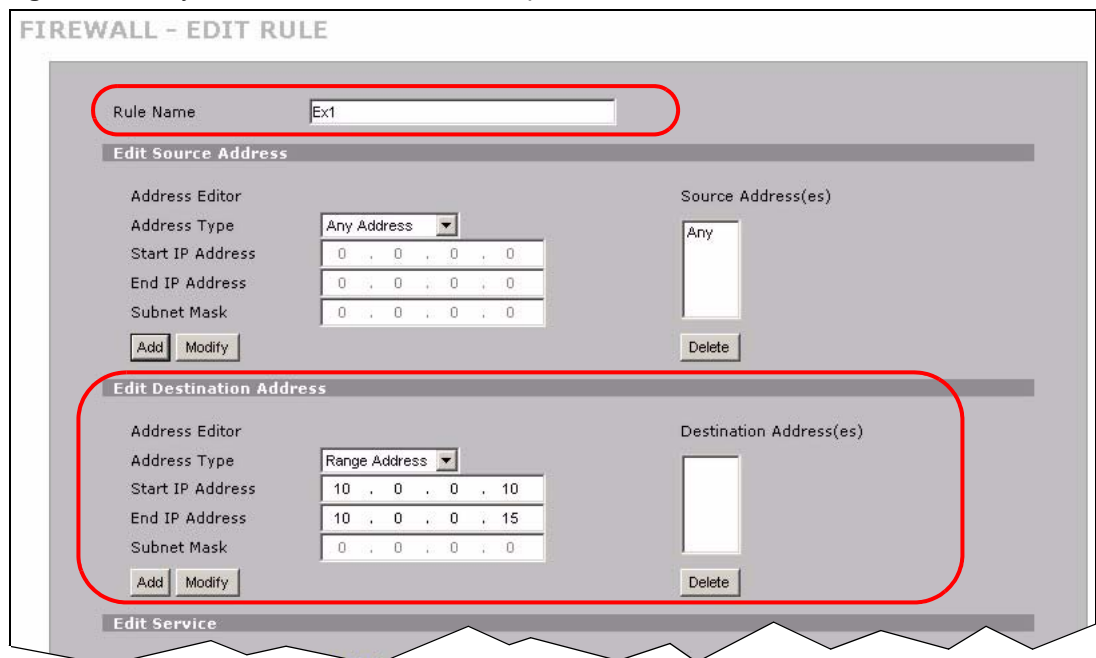

- 9 In the **Edit Rule** screen, use the arrows between **Available Services** and **Selected Service(s)** to configure it as follows. Click **Apply** when you are done.



Custom services show up with an * before their names in the Services list box and the Rule Summary list box.

Figure 138 My Service Firewall Rule Example: Rule Configuration

FIREWALL - EDIT RULE

Rule Name:

Edit Source Address

Address Editor

Address Type:

Start IP Address:

End IP Address:

Subnet Mask:

Source Address(es):

Edit Destination Address

Address Editor

Address Type:

Start IP Address:

End IP Address:

Subnet Mask:

Destination Address(es):

Edit Service

Available Services (See [Service](#))

- Any(All)
- Any(TCP)
- Any(UDP)
- Any(ICMP)
- AIMNEW_ICQ(TCP:5190)
- AUTH(TCP:113)
- BGP(TCP:179)
- BOOTP_CLIENT(UDP:68)
- BOOTP_SERVER(UDP:67)
- CU-SEEME(TCP/UDP:7648,24032)
- DNS(TCP/UDP:53)
- FINGER(TCP:79)
- FTP(TCP:20,21)
- H.323(TCP:1720)
- HTTP(TCP:80)

Selected Service(s)

*My Service(TCP/UDP:1234)

Edit Schedule

Day to Apply:

Sun Mon Tue Wed Thu Fri Sat

Time of Day to Apply: (24-Hour Format)

All day

Start: (Hour) (Minute) End: (Hour) (Minute)

Actions When Matched

Log Packet Information When Matched

Send Alert Message to Administrator When Matched

Action for Matched Packets:

Rule 1 allows a My Service connection from the WAN to IP addresses 10.0.0.10 through 10.0.0.15 on the LAN.

Figure 139 My Service Firewall Rule Example: Rule Summary





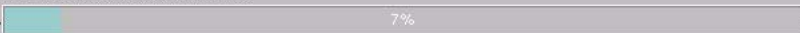

FIREWALL

Default Rule **Rule Summary** Anti-Probing Threshold Service

Rule Summary

Firewall Rules Storage Space in Use
 0%  100%

Packet Direction: WAN to LAN
 Default Policy: Drop, Log

#	Name	Active	Source Address	Destination Address	Service Type	Action	Sch.	Log	Modify
1	Ex1	Y	Any	10.0.0.10 - 10.0.0.15	*My Service(TCP:UDP:1234)	Permit	No	No	 
2	W2L_Rule_1	N	Any	Any	BOOTP_CLIENT(UDP:68)	Permit	No	No	 
3	W2L_Rule_2	N	Any	Any	NetBIOS(TCP:UDP:137~139,445)	Permit	No	No	 

Insert new rule before rule 1 (rule number)

Move rule 1 to rule 1 (rule number)

Content Filtering Screens

This chapter provides an overview of content filtering.

12.1 Content Filtering Overview

Content filtering allows you to block certain web features, such as Cookies, and/or block access to specific websites. With content filtering, you can do the following:

12.1.1 Restrict Web Features

The ZyWALL can block web features such as ActiveX controls, Java applets, cookies and disable web proxies.

12.1.2 Create a Filter List

You can select categories, such as pornography or racial intolerance, to block from a pre-defined list.

12.1.3 Customize Web Site Access

You can specify URLs to which the ZyWALL blocks access. You can alternatively block access to all URLs except ones that you specify. You can also have the ZyWALL block access to URLs that contain key words that you specify.

12.2 Content Filter General Screen

Click **SECURITY > CONTENT FILTER** to open the **CONTENT FILTER General** screen.

Content filtering allows you to block certain web features, such as Cookies, and/or block access to specific websites.

Use this screen to enable content filtering, configure a schedule, and create a denial message. You can also choose specific computers to be included in or excluded from the content filtering configuration.

Figure 140 SECURITY > CONTENT FILTER > General

The following table describes the labels in this screen.

Table 57 SECURITY > CONTENT FILTER > General

LABEL	DESCRIPTION
General Setup	
Enable Content Filter	Select this check box to enable the content filter. Content filtering works on HTTP traffic that is using TCP ports 80, 119, 3128 or 8080.
Enable Content Filter for traffic that matches IPSec policy	Select this check box to have the content filter apply to traffic that the ZyWALL sends out through a VPN tunnel or receives through a VPN tunnel. The ZyWALL applies the content filter to the traffic before encrypting it or after decrypting it. Note: The ZyWALL can apply content filtering on the traffic going to or from the ZyWALL's VPN tunnels. It does not apply to other VPN traffic for which the ZyWALL is not one of the gateways (VPN pass-through traffic).
Restrict Web Features	Select the check box(es) to restrict a feature. When you download a page containing a restricted feature, that part of the web page will appear blank or grayed out.
Block ActiveX	ActiveX is a tool for building dynamic and active web pages and distributed object applications. When you visit an ActiveX web site, ActiveX controls are downloaded to your browser, where they remain in case you visit the site again.

Table 57 SECURITY > CONTENT FILTER > General

LABEL	DESCRIPTION
Java Applet	Java is a programming language and development environment for building downloadable Web components or Internet and intranet business applications of all kinds.
Cookies	Cookies are files stored on a computer's hard drive. Some web servers use them to track usage and provide service based on ID.
Web Proxy	A server that acts as an intermediary between a user and the Internet to provide security, administrative control, and caching service. When a proxy server is located on the WAN it is possible for LAN users to circumvent content filtering by pointing to this proxy server.
Schedule to Block	Content filtering scheduling applies to the Filter List, Customized sites and Keywords. Restricted web server data, such as ActiveX, Java, Cookies and Web Proxy are not affected.
Always Block	Click this option button to have content filtering always active with Time of Day limitations not enforced. This is enabled by default.
Block From/To	Click this option button to have content filtering only active during the time interval(s) specified. In the Block From and To fields, enter the time period(s), in 24-hour format, during which content filtering will be enforced.
Message to display when a site is blocked	
Denied Access Message	Enter a message to be displayed when a user tries to access a restricted web site. The default message is Please contact your network administrator!!
Redirect URL	Enter the URL of the web page to which you want to send users when their web access is blocked by content filtering. The web page you specify here opens in a new frame below the denied access message. Use "http://" followed by up to 120 ASCII characters. For example, http://192.168.1.17/blocked access.
Exempt Computers	
Enforce content filter policies for all computers	Select this checkbox to have all users on your LAN follow content filter policies (default).
Include specified address ranges in the content filter enforcement	Select this checkbox to have a specific range of users on your LAN follow content filter policies.
Exclude specified address ranges from the content filter enforcement	Select this checkbox to exempt a specific range of users on your LAN from content filter policies.
Add Address Ranges	
From	Type the beginning IP address (in dotted decimal notation) of the specific range of users on your LAN.
To	Type the ending IP address (in dotted decimal notation) of the specific range of users on your LAN, then click Add Range .
Address List	This text field shows the address ranges that are blocked.
Add Range	Click Add Range after you have filled in the From and To fields above.
Delete Range	Click Delete Range after you select the range of addresses you wish to delete.

Table 57 SECURITY > CONTENT FILTER > General

LABEL	DESCRIPTION
Apply	Click Apply to save your changes back to the ZyWALL.
Reset	Click Reset to begin configuring this screen afresh.

12.3 Content Filtering with an External Database

When you register for and enable external database content filtering, your ZyWALL accesses an external database that has millions of web sites categorized based on content. You can have the ZyWALL block, block and/or log access to web sites based on these categories. The content filtering lookup process is described below.

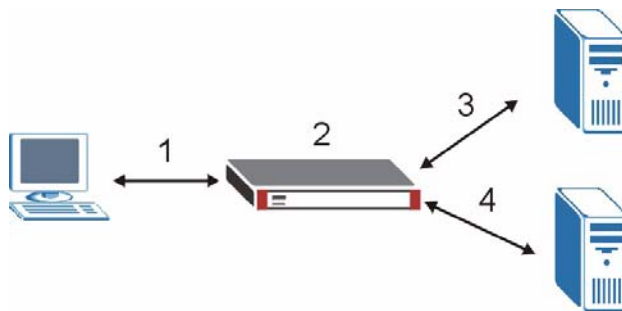
Figure 141 Content Filtering Lookup Procedure

- 1 A computer behind the ZyWALL tries to access a web site.
- 2 The ZyWALL looks up the web site in its cache. If an attempt to access the web site was made in the past, a record of that web site's category will be in the ZyWALL's cache. The ZyWALL blocks, blocks and logs or just logs the request based on your configuration.
- 3 Use the **CONTENT FILTER Cache** screen to configure how long a web site address remains in the cache as well as view those web site addresses (see [Section 12.7 on page 221](#)). All of the web site address records are also cleared from the local cache when the ZyWALL restarts.
- 4 If the ZyWALL has no record of the web site, it will query the external content filtering database and simultaneously send the request to the web server.
The external content filtering database may change a web site's category or categorize a previously uncategorized web site.
- 5 The external content filtering server sends the category information back to the ZyWALL, which then blocks and/or logs access to the web site. The web site's address and category are then stored in the ZyWALL's content filtering cache.

12.4 Content Filter Categories

Click **SECURITY > CONTENT FILTER > Categories** to display the **CONTENT FILTER Categories** screen.

Use this screen to configure category-based content filtering. You can set the ZyWALL to use external database content filtering and select which web site categories to block and/or log. You must register for external content filtering before you can use it. Use the **REGISTRATION** screens (see [Chapter 5 on page 117](#)) to create a myZyXEL.com account, register your device and activate the external content filtering service.

Do the following to view content filtering reports (see [Chapter 13 on page 225](#) for details).

- 1 Log into myZyXEL.com and click your device's link to open it's **Service Management** screen.
- 2 Click **Content Filter** in the **Service Name** field to open the Blue Coat login screen.
- 3 Enter your ZyWALL's MAC address (in lower case) in the **Name** field. You can find this MAC address in the **Service Management** screen ([Figure 147 on page 227](#)). Type your myZyXEL.com account password in the **Password** field. Click **Submit**.

Figure 142 SECURITY > CONTENT FILTER > Categories

The following table describes the labels in this screen.

Table 58 SECURITY > CONTENT FILTER > Categories

LABEL	DESCRIPTION
Auto Category Setup	
Enable External Database Content Filtering	Enable external database content filtering to have the ZyWALL check an external database to find to which category a requested web page belongs. The ZyWALL then blocks or forwards access to the web page depending on the configuration of the rest of this page.

Table 58 SECURITY > CONTENT FILTER > Categories (continued)

LABEL	DESCRIPTION
Matched Web Pages	<p>Select Block to prevent users from accessing web pages that match the categories that you select below.</p> <p>When external database content filtering blocks access to a web page, it displays the denied access message that you configured in the CONTENT FILTER General screen along with the category of the blocked web page.</p> <p>Select Log to record attempts to access prohibited web pages.</p>
Unrated Web Pages	<p>Select Block to prevent users from accessing web pages that the external database content filtering has not categorized.</p> <p>When the external database content filtering blocks access to a web page, it displays the denied access message that you configured in the CONTENT FILTER General screen along with the category of the blocked web page.</p> <p>Select Log to record attempts to access web pages that are not categorized.</p>
When Content Filter Server Is Unavailable	<p>Select Block to block access to any requested web page if the external content filtering database is unavailable. The following are possible causes:</p> <p>There is no response from the external content filtering server within the time period specified in the Content Filter Server Unavailable Timeout field.</p> <p>The ZyWALL is not able to resolve the domain name of the external content filtering database.</p> <p>There is an error response from the external content filtering database. This can be caused by an expired content filtering registration (External content filtering's license key is invalid").</p> <p>Select Log to record attempts to access web pages that occur when the external content filtering database is unavailable.</p>
Content Filter Server Unavailable Timeout	<p>Specify a number of seconds (1 to 30) for the ZyWALL to wait for a response from the external content filtering server. If there is still no response by the time this period expires, the ZyWALL blocks or allows access to the requested web page based on the setting in the Block When Content Filter Server Is Unavailable field.</p>
Select Categories	
Select All Categories	<p>Select this check box to restrict access to all site categories listed below.</p>
Clear All Categories	<p>Select this check box to clear the selected categories below.</p>
Adult/Mature Content	<p>Selecting this category excludes pages that contain material of adult nature that does not necessarily contain excessive violence, sexual content, or nudity. These pages include very profane or vulgar content and pages that are not appropriate for children.</p>
Pornography	<p>Selecting this category excludes pages that contain sexually explicit material for the purpose of arousing a sexual or prurient interest.</p>
Sex Education	<p>Selecting this category excludes pages that provide graphic information (sometimes graphic) on reproduction, sexual development, safe sex practices, sexuality, birth control, and sexual development. It also includes pages that offer tips for better sex as well as products used for sexual enhancement.</p>
Intimate Apparel/Swimsuit	<p>Selecting this category excludes pages that contain images or offer the sale of swimsuits or intimate apparel or other types of suggestive clothing. It does not include pages selling undergarments as a subsection of other products offered.</p>

Table 58 SECURITY > CONTENT FILTER > Categories (continued)

LABEL	DESCRIPTION
Nudity	Selecting this category excludes pages containing nude or seminude depictions of the human body. These depictions are not necessarily sexual in intent or effect, but may include pages containing nude paintings or photo galleries of artistic nature. This category also includes nudist or naturist pages that contain pictures of nude individuals.
Alcohol/Tobacco	Selecting this category excludes pages that promote or offer the sale alcohol/tobacco products, or provide the means to create them. It also includes pages that glorify, tout, or otherwise encourage the consumption of alcohol/tobacco. It does not include pages that sell alcohol or tobacco as a subset of other products.
Illegal/Questionable	<p>Selecting this category excludes pages that advocate or give advice on performing illegal acts such as service theft, evading law enforcement, fraud, burglary techniques and plagiarism. It also includes pages that provide or sell questionable educational materials, such as term papers.</p> <p>Note: This category includes sites identified as being malicious in any way (such as having viruses, spyware and etc.).</p>
Gambling	Selecting this category excludes pages where a user can place a bet or participate in a betting pool (including lotteries) online. It also includes pages that provide information, assistance, recommendations, or training on placing bets or participating in games of chance. It does not include pages that sell gambling related products or machines. It also does not include pages for offline casinos and hotels (as long as those pages do not meet one of the above requirements).
Violence/Hate/Racism	Selecting this category excludes pages that depict extreme physical harm to people or property, or that advocate or provide instructions on how to cause such harm. It also includes pages that advocate, depict hostility or aggression toward, or denigrate an individual or group on the basis of race, religion, gender, nationality, ethnic origin, or other characteristics.
Weapons	Selecting this category excludes pages that sell, review, or describe weapons such as guns, knives or martial arts devices, or provide information on their use, accessories, or other modifications. It does not include pages that promote collecting weapons, or groups that either support or oppose weapons use.
Abortion	Selecting this category excludes pages that provide information or arguments in favor of or against abortion, describe abortion procedures, offer help in obtaining or avoiding abortion, or provide information on the effects, or lack thereof, of abortion.
Arts/Entertainment	Selecting this category excludes pages that promote and provide information about motion pictures, videos, television, music and programming guides, books, comics, movie theatres, galleries, artists or reviews on entertainment.
Business/Economy	Selecting this category excludes pages devoted to business firms, business information, economics, marketing, business management and entrepreneurship. This does not include pages that perform services that are defined in another category (such as Information Technology companies, or companies that sell travel services).
Cult/Occult	Selecting this category excludes pages that promote or offer methods, means of instruction, or other resources to affect or influence real events through the use of spells, curses, magic powers and satanic or supernatural beings.

Table 58 SECURITY > CONTENT FILTER > Categories (continued)

LABEL	DESCRIPTION
Illegal Drugs	Selecting this category excludes pages that promote, offer, sell, supply, encourage or otherwise advocate the illegal use, cultivation, manufacture, or distribution of drugs, pharmaceuticals, intoxicating plants or chemicals and their related paraphernalia.
Education	Selecting this category excludes pages that offer educational information, distance learning and trade school information or programs. It also includes pages that are sponsored by schools, educational facilities, faculty, or alumni groups.
Cultural Institutions	Selecting this category excludes pages sponsored by cultural institutions, or those that provide information about museums, galleries, and theaters (not movie theaters). It includes groups such as 4H and the Boy Scouts of America.
Financial Services	Selecting this category excludes pages that provide or advertise banking services (online or offline) or other types of financial information, such as loans. It does not include pages that offer market information, brokerage or trading services.
Brokerage/Trading	Selecting this category excludes pages that provide or advertise trading of securities and management of investment assets (online or offline). It also includes insurance pages, as well as pages that offer financial investment strategies, quotes, and news.
Games	Selecting this category excludes pages that provide information and support game playing or downloading, video games, computer games, electronic games, tips, and advice on games or how to obtain cheat codes. It also includes pages dedicated to selling board games as well as journals and magazines dedicated to game playing. It includes pages that support or host online sweepstakes and giveaways.
Government/Legal	Selecting this category excludes pages sponsored by or which provide information on government, government agencies and government services such as taxation and emergency services. It also includes pages that discuss or explain laws of various governmental entities.
Military	Selecting this category excludes pages that promote or provide information on military branches or armed services.
Political/Activist Groups	Selecting this category excludes pages sponsored by or which provide information on political parties, special interest groups, or any organization that promotes change or reform in public policy, public opinion, social practice, or economic activities.
Health	Selecting this category excludes pages that provide advice and information on general health such as fitness and well-being, personal health or medical services, drugs, alternative and complimentary therapies, medical information about ailments, dentistry, optometry, general psychiatry, self-help, and support organizations dedicated to a disease or condition.
Computers/Internet	Selecting this category excludes pages that sponsor or provide information on computers, technology, the Internet and technology-related organizations and companies.
Hacking/Proxy Avoidance	Pages providing information on illegal or questionable access to or the use of communications equipment/software, or provide information on how to bypass proxy server features or gain access to URLs in any way that bypasses the proxy server.
Search Engines/Portals	Selecting this category excludes pages that support searching the Internet, indices, and directories.
Web Communications	Selecting this category excludes pages that allow or offer Web-based communication via e-mail, chat, instant messaging, message boards, etc.

Table 58 SECURITY > CONTENT FILTER > Categories (continued)

LABEL	DESCRIPTION
Job Search/Careers	Selecting this category excludes pages that provide assistance in finding employment, and tools for locating prospective employers.
News/Media	Selecting this category excludes pages that primarily report information or comments on current events or contemporary issues of the day. It also includes radio stations and magazines. It does not include pages that can be rated in other categories.
Personals/Dating	Selecting this category excludes pages that promote interpersonal relationships.
Reference	Selecting this category excludes pages containing personal, professional, or educational reference, including online dictionaries, maps, census, almanacs, library catalogues, genealogy-related pages and scientific information.
Chat/Instant Messaging	Selecting this category excludes pages that provide chat or instant messaging capabilities or client downloads.
Email	Selecting this category excludes pages offering web-based email services, such as online email reading, e-cards, and mailing list services.
Newsgroups	Selecting this category excludes pages that offer access to Usenet news groups or other messaging or bulletin board systems.
Religion	Selecting this category excludes pages that promote and provide information on conventional or unconventional religious or quasi-religious subjects, as well as churches, synagogues, or other houses of worship. It does not include pages containing alternative religions such as Wicca or witchcraft (Cult/Occult) or atheist beliefs (Political/Activist Groups).
Shopping	Selecting this category excludes pages that provide or advertise the means to obtain goods or services. It does not include pages that can be classified in other categories (such as vehicles or weapons).
Auctions	Selecting this category excludes pages that support the offering and purchasing of goods between individuals. This does not include classified advertisements.
Real Estate	Selecting this category excludes pages that provide information on renting, buying, or selling real estate or properties.
Society/Lifestyle	Selecting this category excludes pages providing information on matters of daily life. This does not include pages relating to entertainment, sports, jobs, sex or pages promoting alternative lifestyles such as homosexuality. Personal homepages fall within this category if they cannot be classified in another category.
Gay/Lesbian	Selecting this category excludes pages that provide information, promote, or cater to gay and lesbian lifestyles. This does not include pages that are sexually oriented.
Restaurants/Dining/Food	Selecting this category excludes pages that list, review, discuss, advertise and promote food, catering, dining services, cooking and recipes.
Sports/Recreation/Hobbies	Selecting this category excludes pages that promote or provide information about spectator sports, recreational activities, or hobbies. This includes pages that discuss or promote camping, gardening, and collecting.
Travel	Selecting this category excludes pages that promote or provide opportunity for travel planning, including finding and making travel reservations, vehicle rentals, descriptions of travel destinations, or promotions for hotels or casinos.

Table 58 SECURITY > CONTENT FILTER > Categories (continued)

LABEL	DESCRIPTION
Vehicles	Selecting this category excludes pages that provide information on or promote vehicles, boats, or aircraft, including pages that support online purchase of vehicles or parts.
Humor/Jokes	Selecting this category excludes pages that primarily focus on comedy, jokes, fun, etc. This may include pages containing jokes of adult or mature nature. Pages containing humorous Adult/Mature content also have an Adult/Mature category rating.
Streaming Media/MP3/P2P	Selecting this category excludes pages that sell, deliver, or stream music or video content in any format, including pages that provide downloads for such viewers.
Software Downloads	Selecting this category excludes pages that are dedicated to the electronic download of software packages, whether for payment or at no charge.
Pay to Surf	Selecting this category excludes pages that pay users in the form of cash or prizes, for clicking on or reading specific links, email, or web pages.
For Kids	Selecting this category excludes pages designed specifically for children.
Web Advertisements	Selecting this category excludes pages that provide online advertisements or banners. This does not include advertising servers that serve adult-oriented advertisements.
Web Hosting	Selecting this category excludes pages of organizations that provide top-level domain pages, as well as web communities or hosting services.
Advanced/Basic	Click Advanced to see an expanded list of categories, or click Basic to see a smaller list.
Test Web Site Attribute	
Test if Web site is blocked	You can check whether or not the content filter currently blocks any given web page. Enter a web site URL in the text box.
Test Against Local Cache	Click this button to test whether or not the web site above is saved in the ZyWALL's database of restricted web pages.
Test Against Internet Server	Click this button to test whether or not the web site above is saved in the external content filter server's database of restricted web pages.
Content Filter Service Status	<p>This read-only field displays the status of your category-based content filtering (using an external database) service subscription.</p> <p>License Inactive displays if you have not registered and activated the category-based content filtering service.</p> <p>License Active and the subscription expiration date display if you have registered the ZyWALL and activated the category-based content filtering service.</p> <p>Trial Active and the trial subscription expiration date display if you have registered the ZyWALL and activated the category-based content filtering service.</p> <p>License Inactive and the date your subscription expired display if your subscription to the category-based content filtering service has expired.</p> <p>Note: After you register for content filtering, you need to wait up to five minutes for content filtering to be activated. See Section 13.1 on page 225 for how to check the content filtering activation.</p>
Apply	Click Apply to save your changes back to the ZyWALL.
Reset	Click Reset to begin configuring this screen afresh.

12.5 Content Filter Customization

Click **SECURITY > CONTENT FILTER > Customization** to display the **CONTENT FILTER Customization** screen.

You can create a list of good (allowed) web site addresses and a list of bad (blocked) web site addresses. You can also block web sites based on whether the web site's address contains a keyword. Use this screen to add or remove specific sites or keywords from the filter list.

Figure 143 SECURITY > CONTENT FILTER > Customization

The following table describes the labels in this screen.

Table 59 SECURITY > CONTENT FILTER > Customization

LABEL	DESCRIPTION
Web Site List Customization	
Enable Web site customization	Select this check box to allow trusted web sites and block forbidden web sites. Content filter list customization may be enabled and disabled without re-entering these site names.
Disable all Web traffic except for trusted Web sites	When this box is selected, the ZyWALL only allows Web access to sites on the Trusted Web Site list. If they are chosen carefully, this is the most effective way to block objectionable material.

Table 59 SECURITY > CONTENT FILTER > Customization (continued)

LABEL	DESCRIPTION
Don't block Java/ActiveX/ Cookies/Web proxy to trusted Web sites	When this box is selected, the ZyWALL will permit Java, ActiveX and Cookies from sites on the Trusted Web Site list to the LAN. In certain cases, it may be desirable to allow Java, ActiveX or Cookies from sites that are known and trusted.
Trusted Web Sites	These are sites that you want to allow access to, regardless of their content rating, can be allowed by adding them to this list. You can enter up to 32 entries.
Add Trusted Web Site	Enter host names such as www.good-site.com into this text field. Do not enter the complete URL of the site – that is, do not include “http://”. All subdomains are allowed. For example, entering “zyxel.com” also allows “www.zyxel.com”, “partner.zyxel.com”, “press.zyxel.com”, etc.
Trusted Web Sites	This list displays the trusted web sites already added.
Add	Click this button when you have finished adding the host name in the text field above.
Delete	Select a web site name from the Trusted Web Site List , and then click this button to delete it from that list.
Forbidden Web Site List	Sites that you want to block access to, regardless of their content rating, can be allowed by adding them to this list. You can enter up to 32 entries.
Add Forbidden Web Site	Enter host names such as www.bad-site.com into this text field. Do not enter the complete URL of the site – that is, do not include “http://”. All subdomains are blocked. For example, entering “bad-site.com” also blocks “www.bad-site.com”, “partner.bad-site.com”, “press.bad-site.com”, etc.
Forbidden Web Sites	This list displays the forbidden web sites already added.
Add	Click this button when you have finished adding the host name in the text field above.
Delete	Select a web site name from the Forbidden Web Site List , and then click this button to delete it from that list.
Keyword Blocking	Keyword Blocking allows you to block websites with URLs that contain certain keywords in the domain name or IP address. See Section 12.6 on page 221 for how to set how much of the URL the ZyWALL checks.
Block Web sites which contain these keywords.	Select this checkbox to enable keyword blocking.
Add Keyword	Enter a keyword (up to 31 printable ASCII characters) to block. You can also enter a numerical IP address.
Keyword List	This list displays the keywords already added.
Add	Click this button when you have finished adding the key words field above.
Delete	Select a keyword from the Keyword List , and then click this button to delete it from that list.
Apply	Click Apply to save your changes back to the ZyWALL.
Reset	Click Reset to begin configuring this screen afresh.

12.6 Customizing Keyword Blocking URL Checking

You can use commands to set how much of a website's URL the content filter is to check for keyword blocking. See the appendices for information on how to access and use the command interpreter.

12.6.1 Domain Name or IP Address URL Checking

By default, the ZyWALL checks the URL's domain name or IP address when performing keyword blocking.

This means that the ZyWALL checks the characters that come before the first slash in the URL.

For example, with the URL www.zyxel.com.tw/news/pressroom.php, content filtering only searches for keywords within www.zyxel.com.tw.

12.6.2 Full Path URL Checking

Full path URL checking has the ZyWALL check the characters that come before the last slash in the URL.

For example, with the URL www.zyxel.com.tw/news/pressroom.php, full path URL checking searches for keywords within www.zyxel.com.tw/news/.

Use the `ip urlfilter customize actionFlags 6 [disable | enable]` command to extend (or not extend) the keyword blocking search to include the URL's full path.

12.6.3 File Name URL Checking

Filename URL checking has the ZyWALL check all of the characters in the URL.

For example, filename URL checking searches for keywords within the URL www.zyxel.com.tw/news/pressroom.php.

Use the `ip urlfilter customize actionFlags 8 [disable | enable]` command to extend (or not extend) the keyword blocking search to include the URL's complete filename.

12.7 Content Filtering Cache

Click **SECURITY > CONTENT FILTER > Cache** to display the **CONTENT FILTER Cache** screen.

Use this screen to view and configure your ZyWALL's URL caching. You can also configure how long a categorized web site address remains in the cache as well as view those web site addresses to which access has been allowed or blocked based on the responses from the external content filtering server. The ZyWALL only queries the external content filtering database for sites not found in the cache.

You can remove individual entries from the cache. When you do this, the ZyWALL queries the external content filtering database the next time someone tries to access that web site. This allows you to check whether a web site's category has been changed.

Please see [Section 13.3 on page 230](#) for how to submit a web site that has been incorrectly categorized.

Figure 144 SECURITY > CONTENT FILTER > Cache

#	Action	URL	Remaining Time (hour)	Modify
1	Blocked	www.playboy.com/	72	
2	Allowed	ofs.zyxel.com.tw/officescan/cgi/cgiOnUpdate.exe	72	
3	Allowed	www.zyxel.com/	72	
4	Allowed	www.google.com/	72	
5	Allowed	www.bbc.co.uk/	72	
6	Allowed	adstat3.kkman.com.tw/?ver=03000000&ad54=1	72	
7	Allowed	www.yahoo.com.tw/	72	
8	Allowed	www.zyxel.com.tw/	72	

The following table describes the labels in this screen.

Table 60 SECURITY > CONTENT FILTER > Cache

LABEL	DESCRIPTION
URL Cache Setup	
Maximum TTL	Type the maximum time to live (TTL) (1 to 720 hours). This sets how long the ZyWALL is to allow an entry to remain in the URL cache before discarding it.
Apply	Click Apply to save your changes back to the ZyWALL.
Reset	Click Reset to begin configuring this screen afresh.
URL Cache Entry	
Flush	Click this button to clear all web site addresses from the cache manually.
Refresh	Click this button to reload the cache.
#	This is the index number of a categorized web site address record.
Action	This field shows whether access to the web site's URL was blocked-or allowed. Click the column heading to sort the entries. Point the triangle up to display the blocked URLs before the URLs to which access was allowed. Point the triangle down to display the URLs to which access was allowed before the blocked URLs.
URL	This is a web site's address that the ZyWALL previously checked with the external content filtering database.
Port	This is the service port number for which access was requested.

Table 60 SECURITY > CONTENT FILTER > Cache (continued)

LABEL	DESCRIPTION
Remaining Time (hour)	This is the number of hours left before the URL entry is discarded from the cache.
Modify	Click the delete icon to remove the URL entry from the cache.

Content Filtering Reports

This chapter describes how to view content filtering reports after you have activated the category-based content filtering subscription service.

See [Chapter 5 on page 117](#) on how to create a myZyXEL.com account, register your device and activate the subscription services using the **REGISTRATION** screens.

13.1 Checking Content Filtering Activation

After you activate content filtering, you need to wait up to five minutes for content filtering to be turned on.

Since there will be no content filtering activation notice, you can do the following to see if content filtering is active.

- 1 Go to your device's web configurator's **CONTENT FILTER Categories** screen.
- 2 Select at least one category and click **Apply**.
- 3 Enter a valid URL or IP address of a web site in the **Test if Web site is blocked** field and click the **Test Against Internet Server** button.
When content filtering is active, you should see an access blocked or access forwarded message. An error message displays if content filtering is not active.

13.2 Viewing Content Filtering Reports

Content filtering reports are generated statistics and charts of access attempts to web sites belonging to the categories you selected in your device content filter screen.

You need to register your iCard before you can view content filtering reports.

Alternatively, you can also view content filtering reports during the free trial (up to 30 days).

- 1 Go to <http://www.myZyXEL.com>.
- 2 Fill in your myZyXEL.com account information and click **Submit**.

Figure 145 myZyXEL.com: Login

- 3 A welcome screen displays. Click your ZyWALL's model name and/or MAC address under **Registered ZyXEL Products**. You can change the descriptive name for your ZyWALL using the **Rename** button in the **Service Management** screen (see Figure 147 on page 227).

Figure 146 myZyXEL.com: Welcome

- 4 In the **Service Management** screen click **Content Filter** in the **Service Name** field to open the Blue Coat login screen.

Figure 147 myZyXEL.com: Service Management

My Products / Service Activation

Service Management

Product Information

0000AA100043

Serial Number: AAAA100043
 Products: ZYWALL 35
 Authentication Code / MAC Address: 0000AA100043
 Activation Key: N/A

Manage Product

Manage this product's registration by clicking on the appropriate buttons below:

0000AA100043

Applicable Service List

To enable your service(s), please click "Activate" shown below to enter your license key(s).
 To login the Content Filter admin site, please click and input the mac address(lower case) & password.

	Service Name	Service Activation	Status	Expiry Date	Remark
1	Anti Spam	Upgrade	Trial	2005-10-06	-
2	Content Filter	Upgrade	Installed	2006-07-13	-
3	IDP AV	Upgrade	Trial	2005-11-09	-

- 5 Enter your ZyXEL device's MAC address (in lower case) in the **Name** field. You can find this MAC address in the **Service Management** screen (Figure 147 on page 227). Type your myZyXEL.com account password in the **Password** field.
- 6 Click **Submit**.

Figure 148 Blue Coat: Login

ZyXEL Powered By **Blue Coat** [Technical Support](#)

System Login

Welcome to your Blue Coat Web Filter Administration site. Please login using your Username and Password.

Name

Password

- 7 In the **Web Filter Home** screen, click the **Reports** tab.

Figure 149 Content Filtering Reports Main Screen

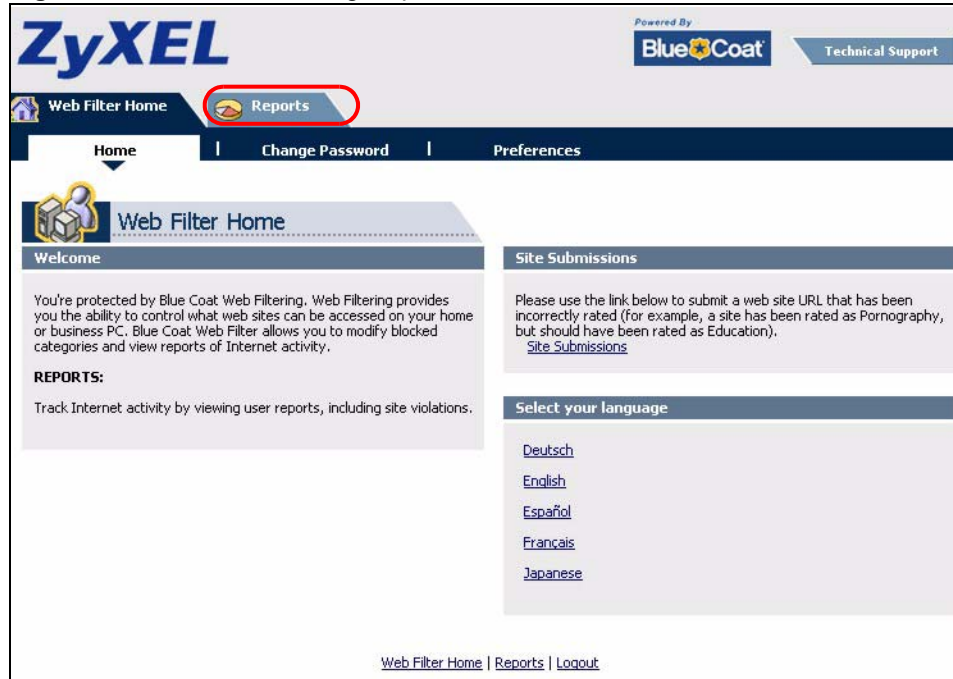

- 8 Select items under **Global Reports** or **Single User Reports** to view the corresponding reports.

Figure 150 Blue Coat: Report Home

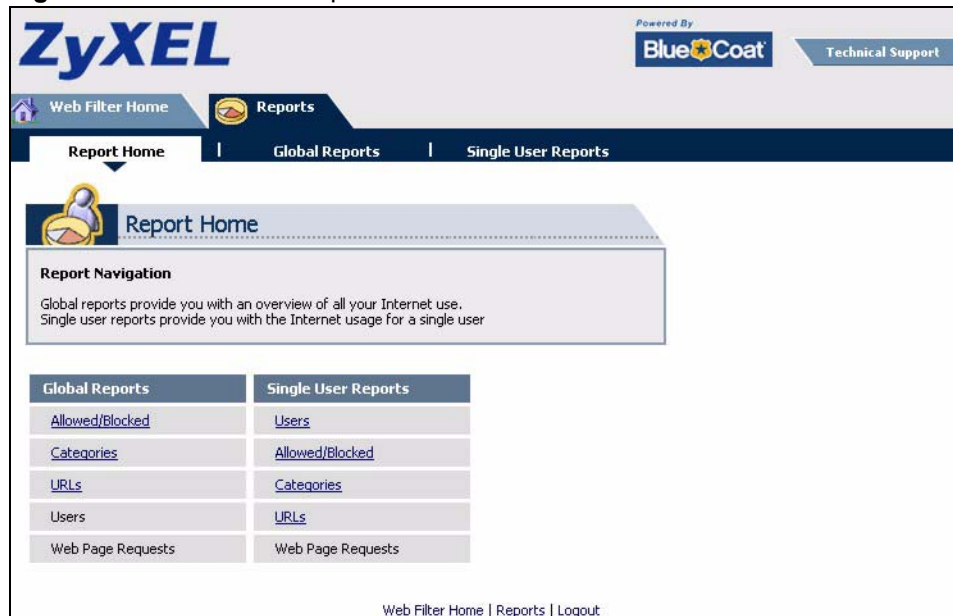

- 9 Select a time period in the **Date Range** field, either **Allowed** or **Blocked** in the **Action Taken** field and a category (or enter the user name if you want to view single user reports) and click **Run Report**. The screens vary according to the report type you selected in the **Report Home** screen.
- 10 A chart and/or list of requested web site categories display in the lower half of the screen.

Figure 151 Global Report Screen Example

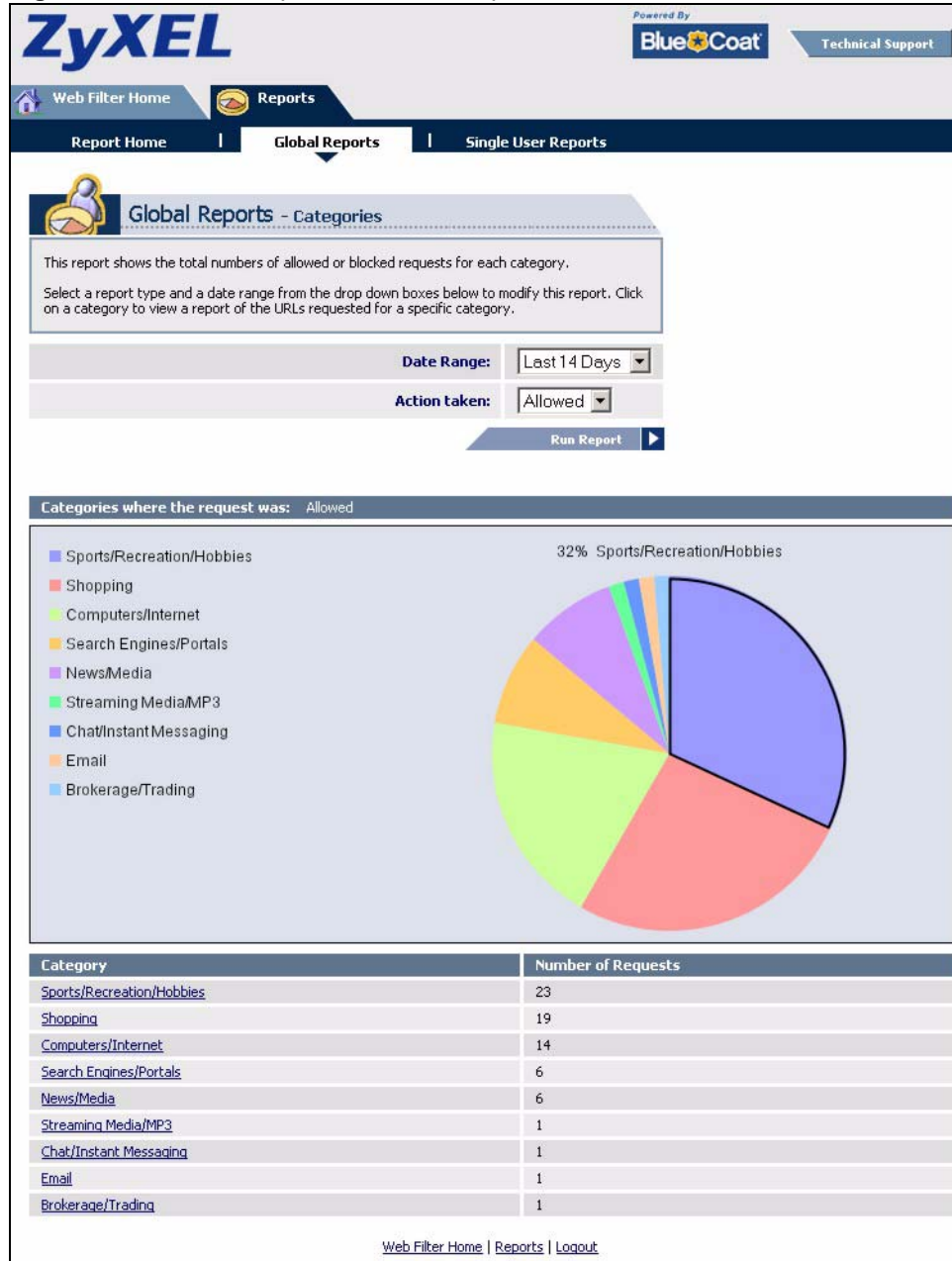

11 You can click a category in the **Categories** report or click **URLs** in the **Report Home** screen to see the URLs that were requested.

Figure 152 Requested URLs Example

ZyXEL Powered By **BlueCoat** Technical Support

Web Filter Home | **Reports** | Report Home | Global Reports | Single User Reports

Global Reports - URLs

This report displays allowed or blocked URLs requested within a specific category.
Click on a URL to view the users that requested that URL.

Date Range: Last 14 Days
Action taken: Allowed
Category: Sports/Recreation/Hobbies
Run Report

URLs Requested for category: Sports/Recreation/Hobbies

Item #	URL	Number of Requests	Open Web Page
1	adsatt.espn.go.com/insertfiles/javascript/flash.js	1	
2	sports.espn.go.com/crossdomain.xml	1	
3	sports.espn.go.com/sports/tvlistings/fp/headerData	1	
4	espn.go.com/Adserver?CallDown&AdTypes=MotionLogo;	1	
5	espn.go.com/myespn/login3.html	1	
6	broadband.espn.go.com/EBB2/popup	1	
7	sports-akt.espn.go.com/espn/format/sponsoredLinkSpot_redesign3	1	
8	sports.espn.go.com/espn/fp/pollData	1	
9	sports.espn.go.com/espn/uti/encodeLess?id=1878300	1	
10	sports.espn.go.com/espn/uti/encodeLess?id=1872951	1	
11	sports.espn.go.com/espn/fp/pollDataJ5	1	
12	static.espn.go.com/swf/fp/superheadline.swf?h=Spur-fect+Ending&tex	1	
13	espn.go.com	1	
14	wimbledon.org/includes/is/external_sb.js	1	
15	espn.go.com/swf/header2005/headers/mlb_hdr.swf	1	
16	espn.go.com/swf/header2005/search/searchBar.swf	1	
17	sports.espn.go.com/mlb/xml/upcomingTV?sport=mlb	1	
18	espn.go.com/insertfiles/javascript/horizNav.js	1	
19	sports.espn.go.com/mlb/index	1	
20	espn.go.com/swf/header2005/tvschedule/tvschedule.swf	1	
21	espn-1.starwave.com/media/apphoto/WATW11606230650_thumbnail.jpeg	1	
22	espn.starwave.com/insertfiles/javascript/motion/motion_index_02.js	1	
23	sports.espn.go.com/espn/fp/pollDataGen?id=30688	1	

Web Filter Home | Reports | Logout

13.3 Web Site Submission

You may find that a web site has not been accurately categorized or that a web site's contents have changed and the content filtering category needs to be updated. Use the following procedure to submit the web site for review.

- 1 Log into the content filtering reports web site (see [Section 13.2 on page 225](#)).
- 2 In the **Web Filter Home** screen (see [Figure 149 on page 228](#)), click **Site Submissions** to open the **Web Page Review Process** screen shown next.

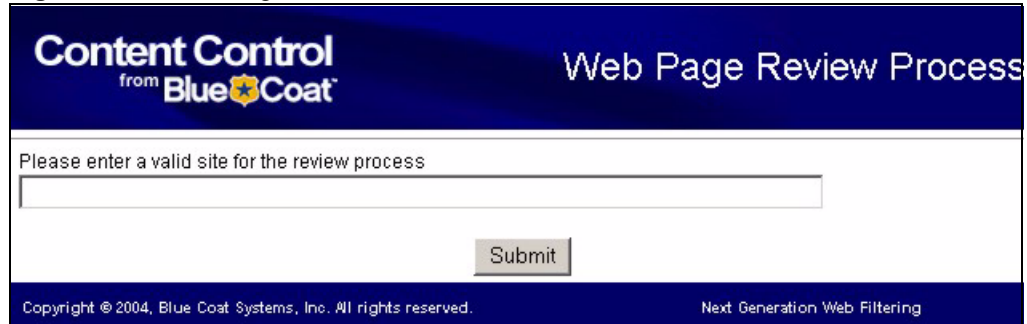
Figure 153 Web Page Review Process Screen

Content Control
from Blue Coat

Web Page Review Process

Please enter a valid site for the review process

Submit

Copyright © 2004, Blue Coat Systems, Inc. All rights reserved. Next Generation Web Filtering

- 3 Type the web site's URL in the field and click **Submit** to have the web site reviewed.

IPSec VPN

This chapter explains how to set up and maintain IPSec VPNs in the ZyWALL. First, it provides an overview of IPSec VPNs. Then, it introduces each screen for IPSec VPN in the ZyWALL.

14.1 IPSec VPN Overview

A virtual private network (VPN) provides secure communications between sites without the expense of leased site-to-site lines. A secure VPN is a combination of tunneling, encryption, authentication, access control and auditing. It is used to transport traffic over the Internet or any insecure network that uses TCP/IP for communication.

Internet Protocol Security (IPSec) is a standards-based VPN that offers flexible solutions for secure data communications across a public network like the Internet. IPSec is built around a number of standardized cryptographic techniques to provide confidentiality, data integrity and authentication at the IP layer.

The following figure provides one perspective of a VPN tunnel.

Figure 154 VPN: Example

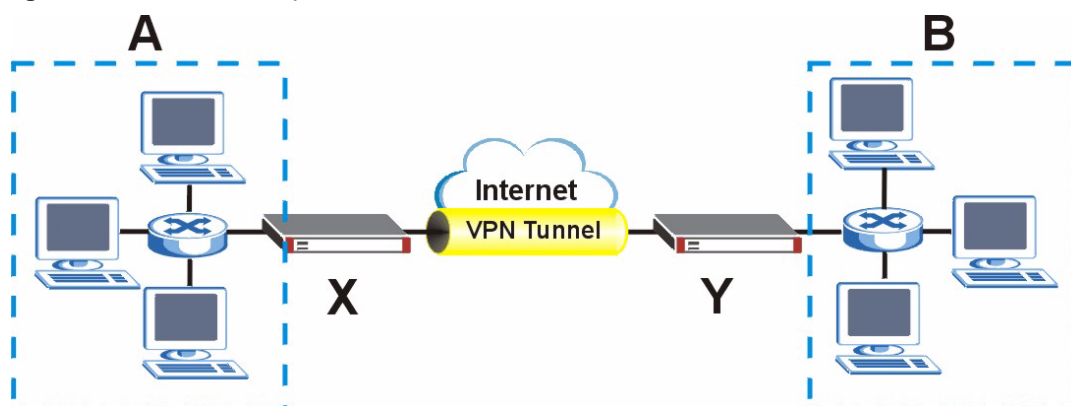

The VPN tunnel connects the ZyWALL (X) and the remote IPsec router (Y). These routers then connect the local network (A) and remote network (B).

A VPN tunnel is usually established in two phases. Each phase establishes a security association (SA), a contract indicating what security parameters the ZyWALL and the remote IPsec router will use. The first phase establishes an Internet Key Exchange (IKE) SA between the ZyWALL and remote IPsec router. The second phase uses the IKE SA to securely establish an IPsec SA through which the ZyWALL and remote IPsec router can send data between computers on the local network and remote network. The following figure illustrates this.

Figure 155 VPN: IKE SA and IPsec SA

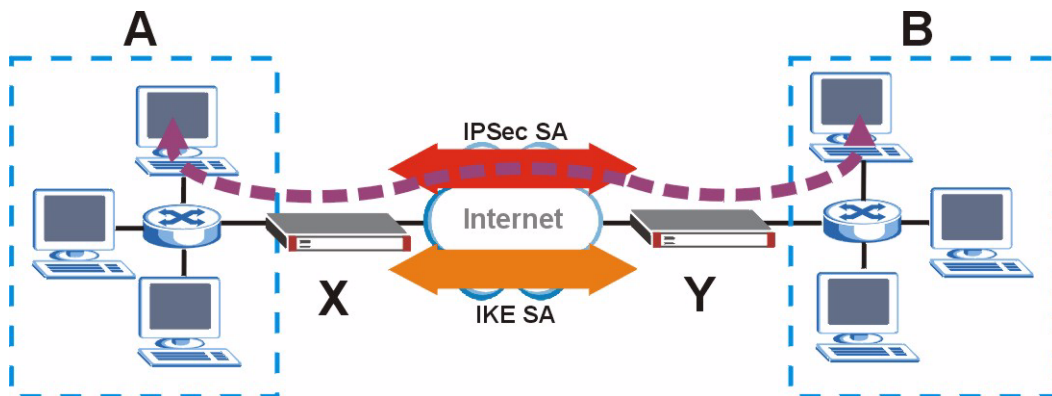

In this example, a computer in network **A** is exchanging data with a computer in network **B**. Inside networks **A** and **B**, the data is transmitted the same way data is normally transmitted in the networks. Between routers **X** and **Y**, the data is protected by tunneling, encryption, authentication, and other security features of the IPsec SA. The IPsec SA is established securely using the IKE SA that routers **X** and **Y** established first.

The rest of this section discusses IKE SA and IPsec SA in more detail.

14.1.1 IKE SA Overview

The IKE SA provides a secure connection between the ZyWALL and remote IPsec router.

It takes several steps to establish an IKE SA. The negotiation mode determines the number of steps to use. There are two negotiation modes--main mode and aggressive mode. Main mode provides better security, while aggressive mode is faster.



Both routers must use the same negotiation mode.

These modes are discussed in more detail in [Section 14.3.1.4 on page 240](#). Main mode is used in various examples in the rest of this section.

14.1.1.1 IP Addresses of the ZyWALL and Remote IPsec Router

In the ZyWALL, you have to specify the IP addresses of the ZyWALL and the remote IPsec router to establish an IKE SA.

You can usually provide a static IP address or a domain name for the ZyWALL. Sometimes, your ZyWALL might also offer another alternative, such as using the IP address of a port or interface.

You can usually provide a static IP address or a domain name for the remote IPSec router as well. Sometimes, you might not know the IP address of the remote IPSec router (for example, telecommuters). In this case, you can still set up the IKE SA, but only the remote IPSec router can initiate an IKE SA.

14.2 VPN Rules (IKE)

A VPN (Virtual Private Network) tunnel gives you a secure connection to another computer or network.

- A gateway policy contains the IKE SA settings. It identifies the IPSec routers at either end of a VPN tunnel.
- A network policy contains the IPSec SA settings. It specifies which devices (behind the IPSec routers) can use the VPN tunnel.

Figure 156 Gateway and Network Policies

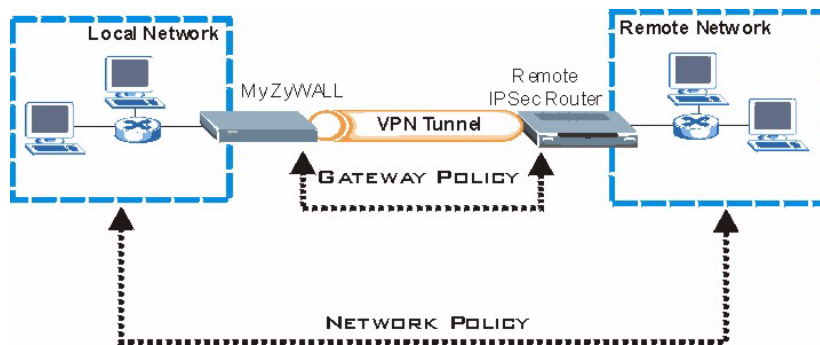

This figure helps explain the main fields in the VPN setup.

Figure 157 IPSec Fields Summary

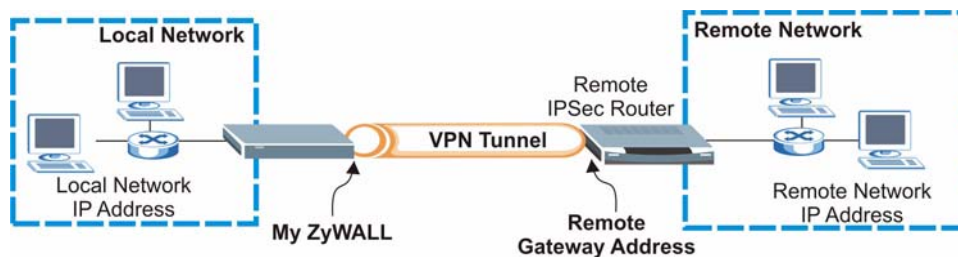

Click **SECURITY > VPN** to display the **VPN Rules (IKE)** screen. Use this screen to manage the ZyWALL's list of VPN rules (tunnels) that use IKE SAs.

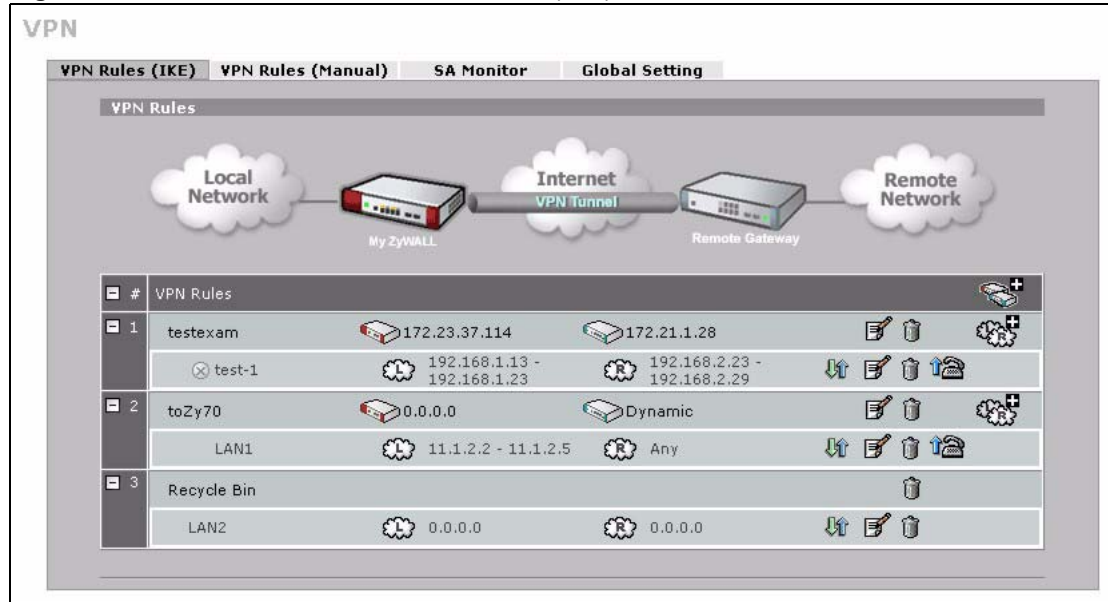
Figure 158 SECURITY > VPN > VPN Rules (IKE)

The following table describes the labels in this screen.

Table 61 SECURITY > VPN > VPN Rules (IKE)











LABEL	DESCRIPTION
VPN Rules	These VPN rules define the settings for creating VPN tunnels for secure connection to other computers or networks.
	Click this icon to add a VPN gateway policy (or IPSec rule).
Gateway Policies	The first row of each VPN rule represents the gateway policy. The gateway policy identifies the IPSec routers at either end of a VPN tunnel (My ZyWALL and Remote Gateway) and specifies the authentication, encryption and other settings needed to negotiate a phase 1 IKE SA (click the edit icon to display the other settings).
 My ZyWALL	This represents your ZyWALL. The WAN IP address, domain name or dynamic domain name of your ZyWALL displays in router mode. The ZyWALL's IP address displays in bridge mode.
 Remote Gateway	This represents the remote secure gateway. The IP address, domain name or dynamic domain name of the remote IPSec router displays if you specify it, otherwise Dynamic displays.
	Click this icon to add a VPN network policy.
Network Policies	The subsequent rows in a VPN rule are network policies. A network policy identifies the devices behind the IPSec routers at either end of a VPN tunnel and specifies the authentication, encryption and other settings needed to negotiate a phase 2 IPSec SA.
 Local Network	This is the network behind the ZyWALL. A network policy specifies which devices (behind the IPSec routers) can use the VPN tunnel.
 Remote Network	This is the remote network behind the remote IPSec router.
	Click this icon to display a screen in which you can associate a network policy to a gateway policy.

Table 61 SECURITY > VPN > VPN Rules (IKE) (continued)

LABEL	DESCRIPTION
	Click this icon to display a screen in which you can change the settings of a gateway or network policy.
	Click this icon to delete a gateway or network policy.
	Click this icon to establish a VPN connection to a remote network.
	This indicates that a network policy is not active.
Recycle Bin	The recycle bin holds any network policies without an associated gateway policy.

14.3 IKE SA Setup

This section provides more details about IKE SAs.

14.3.1 IKE SA Proposal

The IKE SA proposal is used to identify the encryption algorithm, authentication algorithm, and Diffie-Hellman (DH) key group that the ZyWALL and remote IPsec router use in the IKE SA. In main mode, this is done in steps 1 and 2, as illustrated below.

Figure 159 IKE SA: Main Negotiation Mode, Steps 1 - 2: IKE SA Proposal

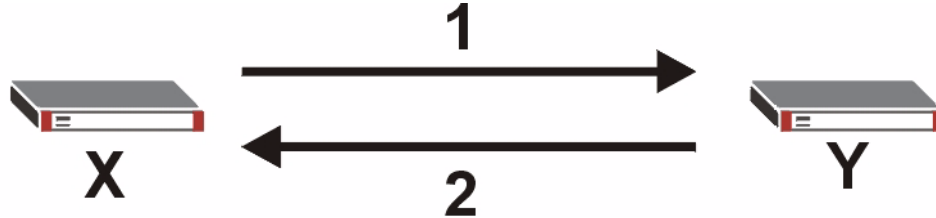

The ZyWALL sends one or more proposals to the remote IPsec router. (In some devices, you can set up only one proposal.) Each proposal consists of an encryption algorithm, authentication algorithm, and DH key group that the ZyWALL wants to use in the IKE SA. The remote IPsec router selects an acceptable proposal and sends the accepted proposal back to the ZyWALL. If the remote IPsec router rejects all of the proposals (for example, if the VPN tunnel is not configured correctly), the ZyWALL and remote IPsec router cannot establish an IKE SA.



Both routers must use the same encryption algorithm, authentication algorithm, and DH key group.

See the field descriptions for information about specific encryption algorithms, authentication algorithms, and DH key groups. See [Section 14.3.1.1 on page 238](#) for more information about DH key groups.

14.3.1.1 Diffie-Hellman (DH) Key Exchange

The ZyWALL and the remote IPSec router use a DH key exchange to establish a shared secret, which is used to generate encryption keys for IKE SA and IPSec SA. In main mode, the DH key exchange is done in steps 3 and 4, as illustrated below.

Figure 160 IKE SA: Main Negotiation Mode, Steps 3 - 4: DH Key Exchange

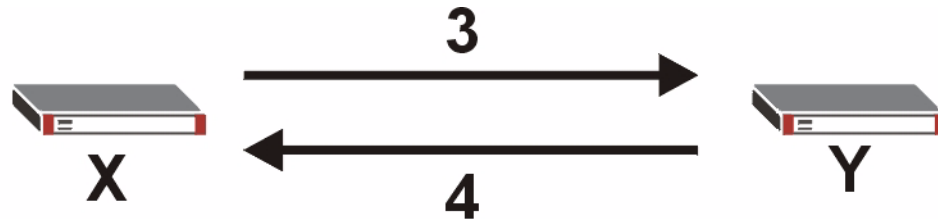

The DH key exchange is based on DH key groups. Each key group is a fixed number of bits long. The longer the key, the more secure the encryption keys, but also the longer it takes to encrypt and decrypt information. For example, DH2 keys (1024 bits) are more secure than DH1 keys (768 bits), but DH2 encryption keys take longer to encrypt and decrypt.

14.3.1.2 Authentication

Before the ZyWALL and remote IPSec router establish an IKE SA, they have to verify each other's identity. This process is based on pre-shared keys and router identities.

In main mode, the ZyWALL and remote IPSec router authenticate each other in steps 5 and 6, as illustrated below. Their identities are encrypted using the encryption algorithm and encryption key the ZyWALL and remote IPSec router selected in previous steps.

Figure 161 IKE SA: Main Negotiation Mode, Steps 5 - 6: Authentication

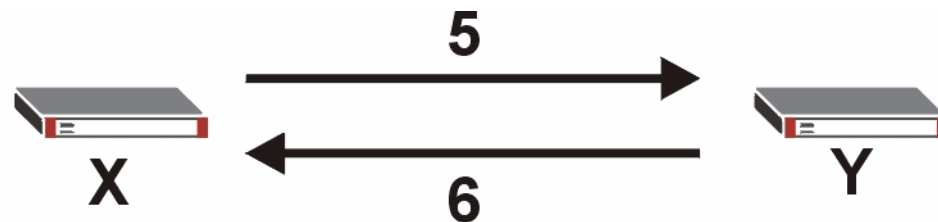

The ZyWALL and remote IPSec router use a pre-shared key in the authentication process, though it is not actually transmitted or exchanged.



The ZyWALL and the remote IPSec router must use the same pre-shared key.

Router identity consists of ID type and ID content. The ID type can be IP address, domain name, or e-mail address, and the ID content is a specific IP address, domain name, or e-mail address. The ID content is only used for identification; the IP address, domain name, or e-mail address that you enter does not have to actually exist.

The ZyWALL and the remote IPsec router each has its own identity, so each one must store two sets of information, one for itself and one for the other router. Local ID type and ID content refers to the ID type and ID content that applies to the router itself, and peer ID type and ID content refers to the ID type and ID content that applies to the other router in the IKE SA.



The ZyWALL's local and peer ID type and ID content must match the remote IPsec router's peer and local ID type and ID content, respectively.

In the following example, the ID type and content match so the ZyWALL and the remote IPsec router authenticate each other successfully.

Table 62 VPN Example: Matching ID Type and Content

ZYWALL	REMOTE IPSEC ROUTER
Local ID type: E-mail	Local ID type: IP
Local ID content: tom@yourcompany.com	Local ID content: 1.1.1.2
Peer ID type: IP	Peer ID type: E-mail
Peer ID content: 1.1.1.2	Peer ID content: tom@yourcompany.com

In the following example, the ID type and content do not match so the authentication fails and the ZyWALL and the remote IPsec router cannot establish an IKE SA.

Table 63 VPN Example: Mismatching ID Type and Content

ZYWALL	REMOTE IPSEC ROUTER
Local ID type: E-mail	Local ID type: IP
Local ID content: tom@yourcompany.com	Local ID content: 1.1.1.2
Peer ID type: IP	Peer ID type: E-mail
Peer ID content: 1.1.1.15	Peer ID content: tom@yourcompany.com

It is also possible to configure the ZyWALL to ignore the identity of the remote IPsec router. In this case, you usually set the peer ID type to **Any**. This is not as secure as other peer ID types, however.

14.3.1.2.1 Certificates

It is also possible for the ZyWALL and remote IPsec router to authenticate each other with certificates. In this case, the authentication process is different.

- Instead of using the pre-shared key, the ZyWALL and remote IPsec router check each other's certificates.
- The local ID type and ID content come from the certificate. On the ZyWALL, you simply select which certificate to use.
- If you set the peer ID type to **Any**, the ZyWALL authenticates the remote IPsec router using the trusted certificates and trusted CAs you have set up. Alternatively, if you want to use a specific certificate to authenticate the remote IPsec router, you can use the information in the certificate to specify the peer ID type and ID content.



You must set up the certificates for the ZyWALL and remote IPsec router before you can use certificates in IKE SA. See [Chapter 15 on page 273](#) for more information about certificates.

14.3.1.3 Extended Authentication

Extended authentication is often used when multiple IPsec routers use the same VPN tunnel to connect to a single IPsec router. For example, this might be used with telecommuters.

Extended authentication occurs right after the authentication described in [Section 14.3.1.2 on page 238](#).

In extended authentication, one of the routers (the ZyWALL or the remote IPsec router) provides a user name and password to the other router, which uses a local user database and/or an external server to verify the user name and password. If the user name or password is wrong, the routers do not establish an IKE SA.

You can set up the ZyWALL to provide a user name and password to the remote IPsec router, or you can set up the ZyWALL to check a user name and password that is provided by the remote IPsec router.

14.3.1.4 Negotiation Mode

There are two negotiation modes: main mode and aggressive mode. Main mode provides better security, while aggressive mode is faster.

Main mode takes six steps to establish an IKE SA.

Steps 1-2: The ZyWALL sends its proposals to the remote IPsec router. The remote IPsec router selects an acceptable proposal and sends it back to the ZyWALL.

Steps 3-4: The ZyWALL and the remote IPsec router participate in a Diffie-Hellman key exchange, based on the accepted DH key group, to establish a shared secret.

Steps 5-6: Finally, the ZyWALL and the remote IPsec router generate an encryption key from the shared secret, encrypt their identities, and exchange their encrypted identity information for authentication.

In contrast, aggressive mode only takes three steps to establish an IKE SA.

Step 1: The ZyWALL sends its proposals to the remote IPsec router. It also starts the Diffie-Hellman key exchange and sends its (unencrypted) identity to the remote IPsec router for authentication.

Step 2: The remote IPsec router selects an acceptable proposal and sends it back to the ZyWALL. It also finishes the Diffie-Hellman key exchange, authenticates the ZyWALL, and sends its (unencrypted) identity to the ZyWALL for authentication.

Step 3: The ZyWALL authenticates the remote IPsec router and confirms that the IKE SA is established.

Aggressive mode does not provide as much security as main mode because the identity of the ZyWALL and the identity of the remote IPsec router are not encrypted. It is usually used when the address of the initiator is not known by the responder and both parties want to use pre-shared keys for authentication (for example, telecommuters).

14.3.1.5 VPN, NAT, and NAT Traversal

In the following example, there is another router (**A**) between router **X** and router **Y**.

Figure 162 VPN/NAT Example

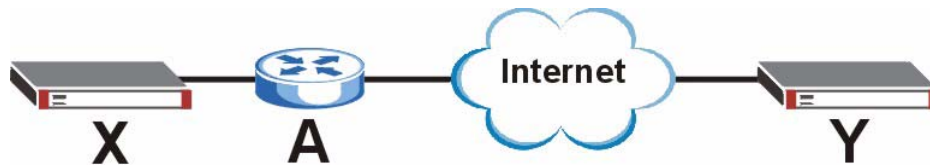

If router **A** does NAT, it might change the IP addresses, port numbers, or both. If router **X** and router **Y** try to establish a VPN tunnel, the authentication fails because it depends on this information. The routers cannot establish a VPN tunnel.

Most routers like router **A** now have an IPsec pass-through feature. This feature helps router **A** recognize VPN packets and route them appropriately. If router **A** has this feature, router **X** and router **Y** can establish a VPN tunnel as long as the active protocol is ESP. (See [Section 14.6.3 on page 251](#) for more information about active protocols.)

If router **A** does not have an IPsec pass-through or if the active protocol is AH, you can solve this problem by enabling NAT traversal. In NAT traversal, router **X** and router **Y** add an extra header to the IKE SA and IPsec SA packets. If you configure router **A** to forward these packets unchanged, router **X** and router **Y** can establish a VPN tunnel.

You have to do the following things to set up NAT traversal.

- Enable NAT traversal on the ZyWALL and remote IPsec router.
- Configure the NAT router to forward packets with the extra header unchanged. (See the field description for detailed information about the extra header.)

The extra header may be UDP port 500 or UDP port 4500, depending on the standard(s) the ZyWALL and remote IPsec router support.

14.4 Additional IPsec VPN Topics

This section discusses other IPsec VPN topics that apply to either IKE SAs or IPsec SAs or both. Relationships between the topics are also highlighted.

14.4.1 SA Life Time

SAs have a lifetime that specifies how long the SA lasts until it times out. When an SA times out, the ZyWALL automatically renegotiates the SA in the following situations:

- There is traffic when the SA life time expires
- The IPsec SA is configured on the ZyWALL as nailed up (see below)

Otherwise, the ZyWALL must re-negotiate the SA the next time someone wants to send traffic.



If the IKE SA times out while an IPsec SA is connected, the IPsec SA stays connected.

An IPsec SA can be set to **nailed up**. Normally, the ZyWALL drops the IPsec SA when the life time expires or after two minutes of outbound traffic with no inbound traffic. If you set the IPsec SA to nailed up, the ZyWALL automatically renegotiates the IPsec SA when the SA life time expires, and it does not drop the IPsec SA if there is no inbound traffic.



The SA life time and nailed up settings only apply if the rule identifies the remote IPsec router by a static IP address or a domain name. If the Remote Gateway Address field is set to 0.0.0.0, the ZyWALL cannot initiate the tunnel (and cannot renegotiate the SA).

14.4.2 IPsec High Availability

IPsec high availability (also known as VPN high availability) allows you to use a redundant (backup) VPN connection to another WAN interface on the remote IPsec router if the primary (regular) VPN connection goes down.

In the following figure, if the primary VPN tunnel (A) goes down, the ZyWALL uses the redundant VPN tunnel (B).

Figure 163 IPsec High Availability

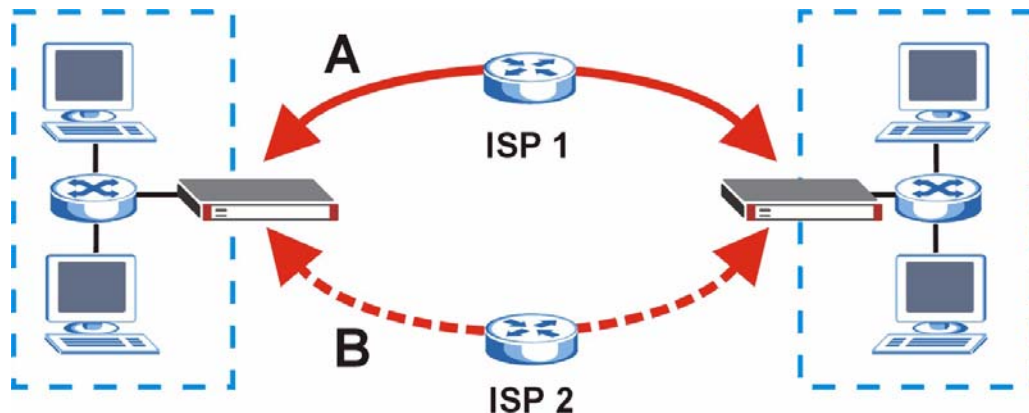

When setting up a IPsec high availability VPN tunnel, the remote IPsec router:

- Must have multiple WAN connections
- Only needs the configure one corresponding IPsec rule
- Should only have IPsec high availability settings in its corresponding IPsec rule if your ZyWALL has multiple WAN connections
- Should ideally identify itself by a domain name or dynamic domain name (it must otherwise have My Address set to 0.0.0.0)
- Should use a WAN connectivity check to this ZyWALL's WAN IP address

If the remote IPSec router is not a ZyWALL, you may also want to avoid setting the IPSec rule to nailed up.

14.4.3 Encryption and Authentication Algorithms

In most ZyWALLs, you can select one of the following encryption algorithms for each proposal. The encryption algorithms are listed here in order from weakest to strongest.



- Data Encryption Standard (DES) is a widely used (but breakable) method of data encryption. It applies a 56-bit key to each 64-bit block of data.
- Triple DES (3DES) is a variant of DES. It iterates three times with three separate keys, effectively tripling the strength of DES.
- Advanced Encryption Standard (AES) is a newer method of data encryption that also uses a secret key. AES applies a 128-bit key to 128-bit blocks of data. It is faster than 3DES.

Use the commands to have the AES encryption apply 192-bit or 256-bit keys to 128-bit blocks of data.

You can select one of the following authentication algorithms for each proposal. The algorithms are listed here in order from weakest to strongest.

- MD5 (Message Digest 5) produces a 128-bit digest to authenticate packet data.
- SHA1 (Secure Hash Algorithm) produces a 160-bit digest to authenticate packet data.

14.5 VPN Rules (IKE) Gateway Policy Edit

In the **VPN Rule (IKE)** screen, click the add gateway policy () icon or the edit () icon to display the **VPN-Gateway Policy -Edit** screen.

Use this screen to configure a VPN gateway policy. The gateway policy identifies the IPSec routers at either end of a VPN tunnel (**My ZyWALL** and **Remote Gateway**) and specifies the authentication, encryption and other settings needed to negotiate a phase 1 IKE SA.

Figure 164 SECURITY > VPN > VPN Rules (IKE) > Edit Gateway Policy

VPN - GATEWAY POLICY - EDIT

Property

Name

NAT Traversal

Gateway Policy Information

 My ZyWALL

My Address (Domain Name or IP Address)

My Domain Name (See [DDNS](#))

 Primary Remote Gateway (Domain Name or IP Address)

Enable IPSec High Availability

 Redundant Remote Gateway (Domain Name or IP Address)

Fall back to Primary Remote Gateway when possible

Fall Back Check Interval* (180~86400 seconds)

*Fall Back Check Interval: The time interval for checking availability of Primary Remote Gateway. IPSec SA life time will be superseded by this value when it is larger than this value.

Authentication Key

Pre-Shared Key

Certificate (See [My Certificates](#))

Local ID Type

Content

Peer ID Type

Content

Extended Authentication

Enable Extended Authentication

Server Mode (Search [Local User](#) first then [RADIUS](#))

Client Mode

User Name

Password

IKE Proposal

Negotiation Mode

Encryption Algorithm

Authentication Algorithm

SA Life Time (Seconds)

Key Group

Enable Multiple Proposals

Associated Network Policies

#	Name	Local Network	Remote Network

The following table describes the labels in this screen.

Table 64 SECURITY > VPN > VPN Rules (IKE) > Edit Gateway Policy

LABEL	DESCRIPTION
Property	
Name	Type up to 32 characters to identify this VPN gateway policy. You may use any character, including spaces, but the ZyWALL drops trailing spaces.
NAT Traversal	<p>Select this check box to enable NAT traversal. NAT traversal allows you to set up a VPN connection when there are NAT routers between the two IPsec routers.</p> <p>Note: The remote IPsec router must also have NAT traversal enabled. See Section 14.3.1.5 on page 241 for more information.</p> <p>You can use NAT traversal with ESP protocol using Transport or Tunnel mode, but not with AH protocol nor with manual key management. In order for an IPsec router behind a NAT router to receive an initiating IPsec packet, set the NAT router to forward UDP ports 500 and 4500 to the IPsec router behind the NAT router.</p>
Gateway Policy Information	
My ZyWALL	<p>When the ZyWALL is in router mode, this field identifies the WAN IP address or domain name of the ZyWALL. You can select My Address and enter the ZyWALL's static WAN IP address (if it has one) or leave the field set to 0.0.0.0. The ZyWALL uses its current WAN IP address (static or dynamic) in setting up the VPN tunnel if you leave this field as 0.0.0.0. If the WAN connection goes down, the ZyWALL uses the dial backup IP address for the VPN tunnel when using dial backup or the LAN IP address when using traffic redirect.</p> <p>Otherwise, you can select My Domain Name and choose one of the dynamic domain names that you have configured (in the DDNS screen) to have the ZyWALL use that dynamic domain name's IP address.</p> <p>When the ZyWALL is in bridge mode, this field is read-only and displays the ZyWALL's IP address.</p> <p>The VPN tunnel has to be rebuilt if the My ZyWALL IP address changes after setup.</p>
Primary Remote Gateway	<p>Type the WAN IP address or the domain name (up to 31 characters) of the IPsec router with which you're making the VPN connection. Set this field to 0.0.0.0 if the remote IPsec router has a dynamic WAN IP address.</p> <p>In order to have more than one active rule with the Remote Gateway Address field set to 0.0.0.0, the ranges of the local IP addresses cannot overlap between rules.</p> <p>If you configure an active rule with 0.0.0.0 in the Remote Gateway Address field and the LAN's full IP address range as the local IP address, then you cannot configure any other active rules with the Remote Gateway Address field set to 0.0.0.0.</p>
Enable IPsec High Availability	<p>Turn on the high availability feature to use a redundant (backup) VPN connection to another WAN interface on the remote IPsec router if the primary (regular) VPN connection goes down. The remote IPsec router must have a second WAN connection in order for you to use this.</p> <p>To use this, you must identify both the primary and the redundant remote IPsec routers by WAN IP address or domain name (you cannot set either to 0.0.0.0).</p>
Redundant Remote Gateway	Type the WAN IP address or the domain name (up to 31 characters) of the backup IPsec router to use when the ZyWALL cannot not connect to the primary remote gateway.

Table 64 SECURITY > VPN > VPN Rules (IKE) > Edit Gateway Policy (continued)

LABEL	DESCRIPTION
Fall back to Primary Remote Gateway when possible	Select this to have the ZyWALL change back to using the primary remote gateway if the connection becomes available again.
Fall Back Check Interval*	Set how often the ZyWALL should check the connection to the primary remote gateway while connected to the redundant remote gateway. Each gateway policy uses one or more network policies. If the fall back check interval is shorter than a network policy's SA life time, the fall back check interval is used as the check interval and network policy SA life time. If the fall back check interval is longer than a network policy's SA life time, the SA lifetime is used as the check interval and network policy SA life time.
Authentication Key	
Pre-Shared Key	Select the Pre-Shared Key radio button and type your pre-shared key in this field. A pre-shared key identifies a communicating party during a phase 1 IKE negotiation. It is called "pre-shared" because you have to share it with another party before you can communicate with them over a secure connection. Type from 8 to 31 case-sensitive ASCII characters or from 16 to 62 hexadecimal ("0-9", "A-F") characters. You must precede a hexadecimal key with a "0x (zero x)", which is not counted as part of the 16 to 62 character range for the key. For example, in "0x0123456789ABCDEF", 0x denotes that the key is hexadecimal and 0123456789ABCDEF is the key itself. Both ends of the VPN tunnel must use the same pre-shared key. You will receive a PYLD_MALFORMED (payload malformed) packet if the same pre-shared key is not used on both ends.
Certificate	Select the Certificate radio button to identify the ZyWALL by a certificate. Use the drop-down list box to select the certificate to use for this VPN tunnel. You must have certificates already configured in the My Certificates screen. Click My Certificates to go to the My Certificates screen where you can view the ZyWALL's list of certificates.
Local ID Type	Select IP to identify this ZyWALL by its IP address. Select DNS to identify this ZyWALL by a domain name. Select E-mail to identify this ZyWALL by an e-mail address. You do not configure the local ID type and content when you set Authentication Key to Certificate . The ZyWALL takes them from the certificate you select.
Content	When you select IP in the Local ID Type field, type the IP address of your computer in the local Content field. The ZyWALL automatically uses the IP address in the My ZyWALL field (refer to the My ZyWALL field description) if you configure the local Content field to 0.0.0.0 or leave it blank. It is recommended that you type an IP address other than 0.0.0.0 in the local Content field or use the DNS or E-mail ID type in the following situations. 1. When there is a NAT router between the two IPsec routers. 2. When you want the remote IPsec router to be able to distinguish between VPN connection requests that come in from IPsec routers with dynamic WAN IP addresses. When you select DNS or E-mail in the Local ID Type field, type a domain name or e-mail address by which to identify this ZyWALL in the local Content field. Use up to 31 ASCII characters including spaces, although trailing spaces are truncated. The domain name or e-mail address is for identification purposes only and can be any string.

Table 64 SECURITY > VPN > VPN Rules (IKE) > Edit Gateway Policy (continued)

LABEL	DESCRIPTION
Peer ID Type	<p>Select from the following when you set Authentication Key to Pre-shared Key. Select IP to identify the remote IPSec router by its IP address. Select DNS to identify the remote IPSec router by a domain name. Select E-mail to identify the remote IPSec router by an e-mail address.</p> <p>Select from the following when you set Authentication Key to Certificate. Select IP to identify the remote IPSec router by the IP address in the subject alternative name field of the certificate it uses for this VPN connection. Select DNS to identify the remote IPSec router by the domain name in the subject alternative name field of the certificate it uses for this VPN connection. Select E-mail to identify the remote IPSec router by the e-mail address in the subject alternative name field of the certificate it uses for this VPN connection. Select Subject Name to identify the remote IPSec router by the subject name of the certificate it uses for this VPN connection. Select Any to have the ZyWALL not check the remote IPSec router's ID.</p>
Content	<p>The configuration of the peer content depends on the peer ID type. Do the following when you set Authentication Key to Pre-shared Key. For IP, type the IP address of the computer with which you will make the VPN connection. If you configure this field to 0.0.0.0 or leave it blank, the ZyWALL will use the address in the Remote Gateway Address field (refer to the Remote Gateway Address field description). For DNS or E-mail, type a domain name or e-mail address by which to identify the remote IPSec router. Use up to 31 ASCII characters including spaces, although trailing spaces are truncated. The domain name or e-mail address is for identification purposes only and can be any string. It is recommended that you type an IP address other than 0.0.0.0 or use the DNS or E-mail ID type in the following situations:</p> <ol style="list-style-type: none"> 1. When there is a NAT router between the two IPSec routers. 2. When you want the ZyWALL to distinguish between VPN connection requests that come in from remote IPSec routers with dynamic WAN IP addresses. <p>Do the following when you set Authentication Key to Certificate.</p> <ol style="list-style-type: none"> 1. For IP, type the IP address from the subject alternative name field of the certificate the remote IPSec router will use for this VPN connection. If you configure this field to 0.0.0.0 or leave it blank, the ZyWALL will use the address in the Remote Gateway Address field (refer to the Remote Gateway Address field description). 2. For DNS or E-mail, type the domain name or e-mail address from the subject alternative name field of the certificate the remote IPSec router will use for this VPN connection. 3. For Subject Name, type the subject name of the certificate the remote IPSec router will use for this VPN connection. Use up to 255 ASCII characters including spaces. 4. For Any, the peer Content field is not available. 5. Regardless of how you configure the ID Type and Content fields, two active IPSec SAs cannot have both the local and remote IP address ranges overlap between rules.
Extended Authentication	
Enable Extended Authentication	Select this check box to activate extended authentication.

Table 64 SECURITY > VPN > VPN Rules (IKE) > Edit Gateway Policy (continued)

LABEL	DESCRIPTION
Server Mode	<p>Select Server Mode to have this ZyWALL authenticate extended authentication clients that request this VPN connection.</p> <p>You must also configure the extended authentication clients' usernames and passwords in the authentication server's local user database or a RADIUS server (see Chapter 16 on page 299).</p> <p>Click Local User to go to the Local User Database screen where you can view and/or edit the list of user names and passwords. Click RADIUS to go to the RADIUS screen where you can configure the ZyWALL to check an external RADIUS server.</p> <p>During authentication, if the ZyWALL (in server mode) does not find the extended authentication clients' user name in its internal user database and an external RADIUS server has been enabled, it attempts to authenticate the client through the RADIUS server.</p>
Client Mode	<p>Select Client Mode to have your ZyWALL use a username and password when initiating this VPN connection to the extended authentication server ZyWALL. Only a VPN extended authentication client can initiate this VPN connection.</p>
User Name	<p>Enter a user name for your ZyWALL to be authenticated by the VPN peer (in server mode). The user name can be up to 31 case-sensitive ASCII characters, but spaces are not allowed. You must enter a user name and password when you select client mode.</p>
Password	<p>Enter the corresponding password for the above user name. The password can be up to 31 case-sensitive ASCII characters, but spaces are not allowed.</p>
IKE Proposal	
Negotiation Mode	<p>Select Main or Aggressive from the drop-down list box. Multiple SAs connecting through a secure gateway must have the same negotiation mode.</p>
Encryption Algorithm	<p>Select which key size and encryption algorithm to use in the IKE SA. Choices are:</p> <ul style="list-style-type: none"> DES - a 56-bit key with the DES encryption algorithm 3DES - a 168-bit key with the DES encryption algorithm AES - a 128-bit key with the AES encryption algorithm <p>The ZyWALL and the remote IPsec router must use the same algorithms and keys. Longer keys require more processing power, resulting in increased latency and decreased throughput.</p>
Authentication Algorithm	<p>Select which hash algorithm to use to authenticate packet data in the IKE SA. Choices are SHA1 and MD5. SHA1 is generally considered stronger than MD5, but it is also slower.</p>
SA Life Time (Seconds)	<p>Define the length of time before an IKE SA automatically renegotiates in this field. It may range from 180 to 3,000,000 seconds (almost 35 days).</p> <p>A short SA Life Time increases security by forcing the two VPN gateways to update the encryption and authentication keys. However, every time the VPN tunnel renegotiates, all users accessing remote resources are temporarily disconnected.</p>
Key Group	<p>Select which Diffie-Hellman key group (DHx) you want to use for encryption keys. Choices are:</p> <ul style="list-style-type: none"> DH1 - use a 768-bit random number DH2 - use a 1024-bit random number
Enable Multiple Proposals	<p>Select this to allow the ZyWALL to use any of its phase 1 key groups and encryption and authentication algorithms when negotiating an IKE SA.</p> <p>When you enable multiple proposals, the ZyWALL allows the remote IPsec router to select which phase 1 key groups and encryption and authentication algorithms to use for the IKE SA, even if they are less secure than the ones you configure for the VPN rule.</p> <p>Clear this to have the ZyWALL use only the configured phase 1 key groups and encryption and authentication algorithms when negotiating an IKE SA.</p>

Table 64 SECURITY > VPN > VPN Rules (IKE) > Edit Gateway Policy (continued)

LABEL	DESCRIPTION
Associated Network Policies	The following table shows the policy(ies) you configure for this rule. To add a VPN policy, click the add network policy () icon in the VPN Rules (IKE) screen (see Figure 158 on page 236). Refer to Section 14.8 on page 256 for more information.
#	This field displays the policy index number.
Name	This field displays the policy name.
Local Network	This field displays one or a range of IP address(es) of the computer(s) behind the ZyWALL.
Remote Network	This field displays one or a range of IP address(es) of the remote network behind the remote IPsec router.
Apply	Click Apply to save your changes back to the ZyWALL.
Cancel	Click Cancel to exit this screen without saving.

14.6 IPsec SA Overview

Once the ZyWALL and remote IPsec router have established the IKE SA, they can securely negotiate an IPsec SA through which to send data between computers on the networks.



The IPsec SA stays connected even if the underlying IKE SA is not available anymore.

This section introduces the key components of an IPsec SA.

14.6.1 Local Network and Remote Network

In an IPsec SA, the local network consists of devices connected to the ZyWALL and may be called the local policy. Similarly, the remote network consists of the devices connected to the remote IPsec router and may be called the remote policy.



It is not recommended to set a VPN rule's local and remote network settings both to 0.0.0.0 (any). This causes the ZyWALL to try to forward all access attempts (to the local network, the Internet or even the ZyWALL) to the remote IPsec router. In this case, you can no longer manage the ZyWALL.

If you select the **VPN rules skip applying to the overlap range of local and remote IP addresses** option (see [Figure 174 on page 264](#)) and the VPN rule's local and remote network settings are both 0.0.0.0 (any), no traffic will go through the VPN tunnel.

14.6.1.1 Overlapping Local And Remote Network IP Addresses

Devices behind the ZyWALL (local devices) and the devices behind the remote IPsec router (remote devices) may use private IP addresses. Therefore it is possible that local devices and remote devices may have the same IP addresses. This is known as overlapping local and remote IP addresses.

For example, local network **X** uses IP addresses 192.168.1.2 to 192.168.1.4. Remote network **Y** uses IP addresses 192.168.1.2 to 192.168.1.27.

If you select the **VPN rules skip applying to the overlap range of local and remote IP addresses** option (see [Figure 174 on page 264](#)), every time a computer on network **X** tries to access a network **X** computer with an IP address from 192.168.1.2 to 192.168.1.4, the ZyWALL sends the traffic through the VPN tunnel to network **Y**.

If you clear the **VPN rules skip applying to the overlap range of local and remote IP addresses** option (see [Figure 174 on page 264](#)), every time a computer on network **X** tries to access a network **X** computer with an IP address from 192.168.1.2 to 192.168.1.4, the ZyWALL sends the traffic to the local network.

Figure 165 Local and Remote Network IP Address Overlap

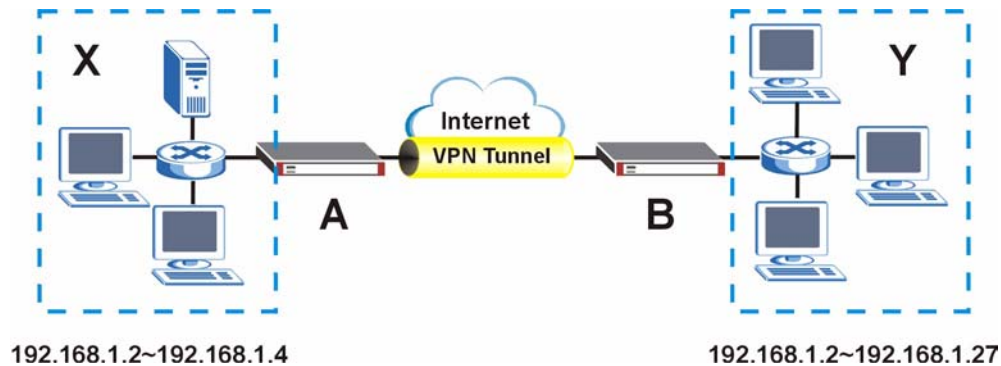

14.6.2 Virtual Address Mapping

Virtual address mapping (NAT over IPsec) changes the source IP addresses of packets from your local devices to virtual IP addresses before sending them through the VPN tunnel.

14.6.2.1 Avoiding Overlapping Local And Remote Network IP Addresses

If both IPsec routers support virtual address mapping, you can access devices on both networks, even if their IP addresses overlap. You map the ZyWALL's local network addresses to virtual IP addresses and map the remote IPsec router's local IP addresses to other (non-overlapping) virtual IP addresses.

Take [Section 14.6.1.1 on page 250](#) as an example of overlapping local and remote IP addresses. You can set up virtual address mapping on both IPsec routers to allow computers on network **X** to access network **X** and network **Y** computers with the same IP address.

- You set ZyWALL **A** to change the source IP addresses of packets from local network **X** (192.168.1.2 to 192.168.1.4) to virtual IP addresses 10.0.0.2 to 10.0.0.4 before sending them through the VPN tunnel.
- You set ZyWALL **B** to change the source IP addresses of packets from the remote network **Y** (192.168.1.2 to 192.168.1.27) to virtual IP addresses 172.21.2.2 to 172.21.2.27 before sending them through the VPN tunnel.

- On ZyWALL **A**, you specify 172.21.2.2 to 172.21.2.27 as the remote network. On ZyWALL **B**, you specify 10.0.0.2 to 10.0.0.4 as the remote network.

Figure 166 Virtual Mapping of Local and Remote Network IP Addresses

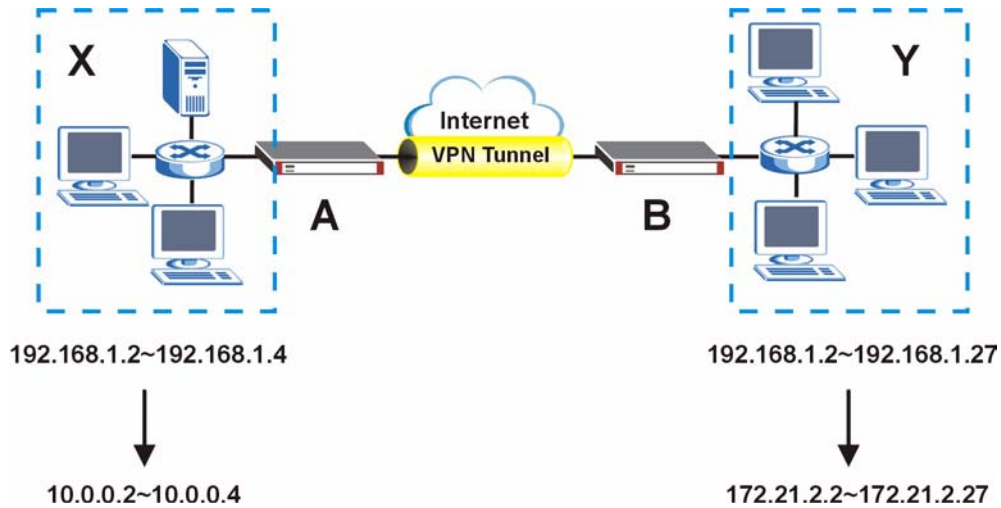

Computers on network **X** use IP addresses 192.168.1.2 to 192.168.1.4 to access local network devices and IP addresses 172.21.2.2 to 172.21.2.27 to access the remote network devices.

Computers on network **Y** use IP addresses 192.168.1.2 to 192.168.1.27 to access local network devices and IP addresses 10.0.0.2 to 10.0.0.4 to access the remote network devices.

14.6.3 Active Protocol

The active protocol controls the format of each packet. It also specifies how much of each packet is protected by the encryption and authentication algorithms. IPsec VPN includes two active protocols, AH (Authentication Header, RFC 2402) and ESP (Encapsulating Security Payload, RFC 2406).



The ZyWALL and remote IPsec router must use the same active protocol.

Usually, you should select ESP. AH does not support encryption, and ESP is more suitable with NAT.

14.6.4 Encapsulation

There are two ways to encapsulate packets. Usually, you should use tunnel mode because it is more secure. Transport mode is only used when the IPsec SA is used for communication between the ZyWALL and remote IPsec router (for example, for remote management), not between computers on the local and remote networks.



The ZyWALL and remote IPSec router must use the same encapsulation.

These modes are illustrated below.

Figure 167 VPN: Transport and Tunnel Mode Encapsulation

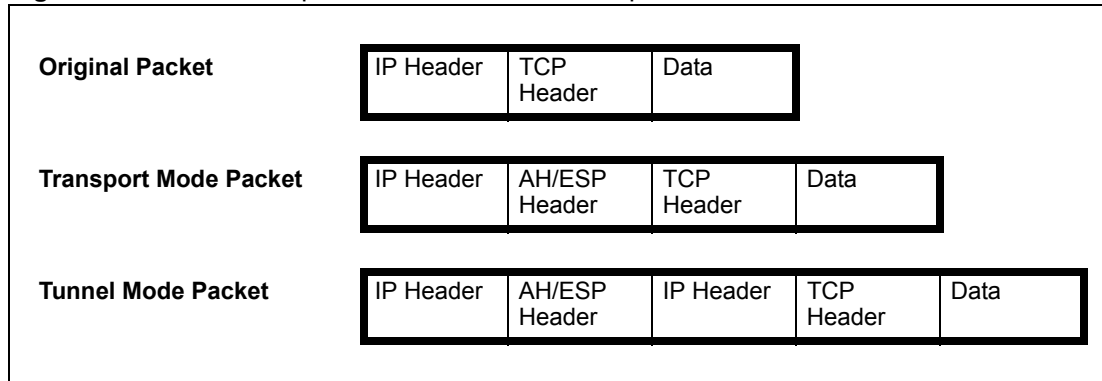

In tunnel mode, the ZyWALL uses the active protocol to encapsulate the entire IP packet. As a result, there are two IP headers:

- **Outside header:** The outside IP header contains the IP address of the ZyWALL or remote IPSec router, whichever is the destination.
- **Inside header:** The inside IP header contains the IP address of the computer behind the ZyWALL or remote IPSec router. The header for the active protocol (AH or ESP) appears between the IP headers.

In transport mode, the encapsulation depends on the active protocol. With AH, the ZyWALL includes part of the original IP header when it encapsulates the packet. With ESP, however, the ZyWALL does not include the IP header when it encapsulates the packet, so it is not possible to verify the integrity of the source IP address.

14.6.5 IPSec SA Proposal and Perfect Forward Secrecy

An IPSec SA proposal is similar to an IKE SA proposal (see [Section 14.3.1 on page 237](#)), except that you also have the choice whether or not the ZyWALL and remote IPSec router perform a new DH key exchange every time an IPSec SA is established. This is called Perfect Forward Secrecy (PFS).

If you enable PFS, the ZyWALL and remote IPSec router perform a DH key exchange every time an IPSec SA is established, changing the root key from which encryption keys are generated. As a result, if one encryption key is compromised, other encryption keys remain secure.

If you do not enable PFS, the ZyWALL and remote IPSec router use the same root key that was generated when the IKE SA was established to generate encryption keys.

The DH key exchange is time-consuming and may be unnecessary for data that does not require such security.

14.7 VPN Rules (IKE): Network Policy Edit

Click **SECURITY > VPN** and the add network policy () icon in the **VPN Rules (IKE)** screen to display the **VPN-Network Policy -Edit** screen. Use this screen to configure a network policy. A network policy identifies the devices behind the IPSec routers at either end of a VPN tunnel and specifies the authentication, encryption and other settings needed to negotiate a phase 2 IPSec SA.

Figure 168 SECURITY > VPN > VPN Rules (IKE) > Edit Network Policy

VPN - NETWORK POLICY - EDIT

Property

Active

Name

Protocol

Nailed-Up

Allow NetBIOS Traffic Through IPSec Tunnel

Check IPSec Tunnel Connectivity Log

Ping this Address

Gateway Policy Information

 Gateway Policy

Virtual Address Mapping Rule:

Active

Virtual Address Mapping Rule:

Type

Private Starting IP Address

Private Ending IP Address

Virtual Starting IP Address

Virtual Ending IP Address

Local Network

 Address Type

Starting IP Address

Ending IP Address / Subnet Mask

Local Port Start End

Remote Network

 Address Type

Starting IP Address

Ending IP Address / Subnet Mask

Remote Port Start End

IPSec Proposal

Encapsulation Mode

Active Protocol

Encryption Algorithm

Authentication Algorithm

SA Life Time (Seconds)

Perfect Forward Secrecy (PFS)

Enable Replay Detection

Enable Multiple Proposals

The following table describes the labels in this screen.

Table 65 SECURITY > VPN > VPN Rules (IKE) > Edit Network Policy

LABEL	DESCRIPTION
Active	<p>If the Active check box is selected, packets for the tunnel trigger the ZyWALL to build the tunnel.</p> <p>Clear the Active check box to turn the network policy off. The ZyWALL does not apply the policy. Packets for the tunnel do not trigger the tunnel.</p> <p>If you clear the Active check box while the tunnel is up (and click Apply), you turn off the network policy and the tunnel goes down.</p>
Name	Type a name to identify this VPN network policy. You may use any character, including spaces, but the ZyWALL drops trailing spaces.
Protocol	Enter 1 for ICMP, 6 for TCP, 17 for UDP, etc. 0 is the default and signifies any protocol.
Nailed-Up	<p>Select this check box to turn on the nailed up feature for this SA.</p> <p>Turn on nailed up to have the ZyWALL automatically reinitiate the SA after the SA lifetime times out, even if there is no traffic. The ZyWALL also reinitiates the SA when it restarts.</p> <p>The ZyWALL also rebuilds the tunnel if it was disconnected due to the output or input idle timer.</p>
Allow NetBIOS Traffic Through IPSec Tunnel	<p>This field is not available when the ZyWALL is in bridge mode.</p> <p>NetBIOS (Network Basic Input/Output System) are TCP or UDP packets that enable a computer to connect to and communicate with a LAN. It may sometimes be necessary to allow NetBIOS packets to pass through VPN tunnels in order to allow local computers to find computers on the remote network and vice versa.</p> <p>Select this check box to send NetBIOS packets through the VPN connection.</p>
Check IPSec Tunnel Connectivity	<p>Select the check box and configure an IP address in the Ping this Address field to have the ZyWALL periodically test the VPN tunnel to the remote IPSec router.</p> <p>The ZyWALL pings the IP address every minute. The ZyWALL starts the IPSec connection idle timeout timer when it sends the ping packet. If there is no traffic from the remote IPSec router by the time the timeout period expires, the ZyWALL disconnects the VPN tunnel.</p>
Log	Select this check box to set the ZyWALL to create logs when it cannot ping the remote device.
Ping this Address	If you select Check IPSec Tunnel Connectivity , enter the IP address of a computer at the remote IPSec network. The computer's IP address must be in this IP policy's remote range (see the Remote Network fields).
Gateway Policy Information	
Gateway Policy	Select the gateway policy with which you want to use the VPN policy.
Local Network	<p>Specify the IP addresses of the devices behind the ZyWALL that can use the VPN tunnel. The local IP addresses must correspond to the remote IPSec router's configured remote IP addresses. You do not configure the Local Network fields when you enable virtual address mapping.</p> <p>Two active SAs cannot have the local and remote IP address(es) both the same. Two active SAs can have the same local or remote IP address, but not both. You can configure multiple SAs between the same local and remote IP addresses, as long as only one is active at any time.</p>
Address Type	Use the drop-down list box to choose Single Address , Range Address , or Subnet Address . Select Single Address for a single IP address. Select Range Address for a specific range of IP addresses. Select Subnet Address to specify IP addresses on a network by their subnet mask.

Table 65 SECURITY > VPN > VPN Rules (IKE) > Edit Network Policy (continued)

LABEL	DESCRIPTION
Starting IP Address	When the Address Type field is configured to Single Address , enter a (static) IP address on the LAN behind your ZyWALL. When the Address Type field is configured to Range Address , enter the beginning (static) IP address, in a range of computers on the LAN behind your ZyWALL. When the Address Type field is configured to Subnet Address , this is a (static) IP address on the LAN behind your ZyWALL.
Ending IP Address/ Subnet Mask	When the Address Type field is configured to Single Address , this field is N/A. When the Address Type field is configured to Range Address , enter the end (static) IP address, in a range of computers on the LAN behind your ZyWALL. When the Address Type field is configured to Subnet Address , this is a subnet mask on the LAN behind your ZyWALL.
Local Port	0 is the default and signifies any port. Type a port number from 0 to 65535 in the Start and End fields. Some of the most common IP ports are: 21, FTP; 53, DNS; 23, Telnet; 80, HTTP; 25, SMTP; 110, POP3.
Remote Network	Specify the IP addresses of the devices behind the remote IPsec router that can use the VPN tunnel. The remote IP addresses must correspond to the remote IPsec router's configured local IP addresses. Two active SAs cannot have the local and remote IP address(es) both the same. Two active SAs can have the same local or remote IP address, but not both. You can configure multiple SAs between the same local and remote IP addresses, as long as only one is active at any time.
Address Type	Use the drop-down list box to choose Single Address , Range Address , or Subnet Address . Select Single Address with a single IP address. Select Range Address for a specific range of IP addresses. Select Subnet Address to specify IP addresses on a network by their subnet mask.
Starting IP Address	When the Address Type field is configured to Single Address , enter a (static) IP address on the network behind the remote IPsec router. When the Address Type field is configured to Range Address , enter the beginning (static) IP address, in a range of computers on the network behind the remote IPsec router. When the Address Type field is configured to Subnet Address , enter a (static) IP address on the network behind the remote IPsec router.
Ending IP Address/ Subnet Mask	When the Address Type field is configured to Single Address , this field is N/A. When the Address Type field is configured to Range Address , enter the end (static) IP address, in a range of computers on the network behind the remote IPsec router. When the Address Type field is configured to Subnet Address , enter a subnet mask on the network behind the remote IPsec router.
Remote Port	0 is the default and signifies any port. Type a port number from 0 to 65535 in the Start and End fields. Some of the most common IP ports are: 21, FTP; 53, DNS; 23, Telnet; 80, HTTP; 25, SMTP; 110, POP3.
IPsec Proposal	
Encapsulation Mode	Select Tunnel mode or Transport mode.
Active Protocol	Select the security protocols used for an SA. Both AH and ESP increase processing requirements and communications latency (delay).
Encryption Algorithm	Select which key size and encryption algorithm to use in the IKE SA. Choices are: NULL - no encryption key or algorithm DES - a 56-bit key with the DES encryption algorithm 3DES - a 168-bit key with the DES encryption algorithm AES - a 128-bit key with the AES encryption algorithm The ZyWALL and the remote IPsec router must use the same algorithms and keys. Longer keys require more processing power, resulting in increased latency and decreased throughput.

Table 65 SECURITY > VPN > VPN Rules (IKE) > Edit Network Policy (continued)

LABEL	DESCRIPTION
Authentication Algorithm	Select which hash algorithm to use to authenticate packet data in the IPSec SA. Choices are SHA1 and MD5 . SHA1 is generally considered stronger than MD5 , but it is also slower.
SA Life Time (Seconds)	Define the length of time before an IPSec SA automatically renegotiates in this field. The minimum value is 180 seconds. A short SA Life Time increases security by forcing the two VPN gateways to update the encryption and authentication keys. However, every time the VPN tunnel renegotiates, all users accessing remote resources are temporarily disconnected.
Perfect Forward Secret (PFS)	Select whether or not you want to enable Perfect Forward Secrecy (PFS) and, if you do, which Diffie-Hellman key group to use for encryption. Choices are: NONE - disable PFS DH1 - enable PFS and use a 768-bit random number DH2 - enable PFS and use a 1024-bit random number PFS changes the root key that is used to generate encryption keys for each IPSec SA. It is more secure but takes more time.
Enable Replay Detection	As a VPN setup is processing intensive, the system is vulnerable to Denial of Service (DOS) attacks. The IPSec receiver can detect and reject old or duplicate packets to protect against replay attacks. Enable replay detection by selecting this check box.
Enable Multiple Proposals	Select this to allow the ZyWALL to use any of its phase 2 encryption and authentication algorithms when negotiating an IPSec SA. When you enable multiple proposals, the ZyWALL allows the remote IPSec router to select which phase 2 encryption and authentication algorithms to use for the IPSec SA, even if they are less secure than the ones you configure for the VPN rule. Clear this to have the ZyWALL use only the configured phase 2 encryption and authentication algorithms when negotiating an IPSec SA.
Apply	Click Apply to save the changes.
Cancel	Click Cancel to discard all changes and return to the main VPN screen.

14.8 VPN Rules (IKE): Network Policy Edit: Port Forwarding

Click **SECURITY > VPN** and the add network policy (🔗) icon in the **VPN Rules (IKE)** screen to display the **VPN-Network Policy -Edit** screen. Then, under **Virtual Address Mapping Rule**, select **Many-to-One** as the **Type** and click the **Port Forwarding Rules** button to open the following screen. Use this screen to configure port forwarding for your VPN tunnels to let the ZyWALL forward traffic coming in through the VPN tunnel to the appropriate IP address on the LAN.

Figure 169 SECURITY > VPN > VPN Rules (IKE) > Edit Network Policy > Port Forwarding

VPN - NETWORK POLICY - PORT FORWARDING RULES

Port Forwarding Rules

Default Server

#	Active	Name	Start Port	End Port	Server IP Address
1	<input type="checkbox"/>	<input type="text"/>	<input type="text" value="0"/>	<input type="text" value="0"/>	<input type="text" value="0.0.0.0"/>
2	<input type="checkbox"/>	<input type="text"/>	<input type="text" value="0"/>	<input type="text" value="0"/>	<input type="text" value="0.0.0.0"/>
3	<input type="checkbox"/>	<input type="text"/>	<input type="text" value="0"/>	<input type="text" value="0"/>	<input type="text" value="0.0.0.0"/>
4	<input type="checkbox"/>	<input type="text"/>	<input type="text" value="0"/>	<input type="text" value="0"/>	<input type="text" value="0.0.0.0"/>
5	<input type="checkbox"/>	<input type="text"/>	<input type="text" value="0"/>	<input type="text" value="0"/>	<input type="text" value="0.0.0.0"/>
6	<input type="checkbox"/>	<input type="text"/>	<input type="text" value="0"/>	<input type="text" value="0"/>	<input type="text" value="0.0.0.0"/>
7	<input type="checkbox"/>	<input type="text"/>	<input type="text" value="0"/>	<input type="text" value="0"/>	<input type="text" value="0.0.0.0"/>
8	<input type="checkbox"/>	<input type="text"/>	<input type="text" value="0"/>	<input type="text" value="0"/>	<input type="text" value="0.0.0.0"/>
9	<input type="checkbox"/>	<input type="text"/>	<input type="text" value="0"/>	<input type="text" value="0"/>	<input type="text" value="0.0.0.0"/>
10	<input type="checkbox"/>	<input type="text"/>	<input type="text" value="0"/>	<input type="text" value="0"/>	<input type="text" value="0.0.0.0"/>
11	<input type="checkbox"/>	<input type="text"/>	<input type="text" value="0"/>	<input type="text" value="0"/>	<input type="text" value="0.0.0.0"/>

The following table describes the labels in this screen.

Table 66 SECURITY > VPN > VPN Rules (IKE) > Edit Network Policy > Port Forwarding

LABEL	DESCRIPTION
Default Server	In addition to the servers for specified services, NAT supports a default server. A default server receives packets from ports that are not specified in this screen. If you do not assign a default server IP address, all packets received for ports not specified in this screen are discarded.
#	Number of an individual port forwarding server entry.
Active	Select this check box to activate the port forwarding server entry.
Name	Enter a descriptive name for identifying purposes.
Start Port	Type a port number in this field. To forward only one port, type the port number again in the End Port field. To forward a series of ports, type the start port number here and the end port number in the End Port field.
End Port	Type a port number in this field. To forward only one port, type the port number in the Start Port field above and then type it again in this field. To forward a series of ports, type the last port number in a series that begins with the port number in the Start Port field above.
Server IP Address	Type your server IP address in this field.
Apply	Click this button to save these settings.
Reset	Click this button to begin configuring this screen afresh.
Cancel	Click this button to return to the VPN-Network Policy -Edit screen without saving your changes.

14.9 VPN Rules (IKE): Network Policy Move

Click the move () icon in the **VPN Rules (IKE)** screen to display the **VPN Rules (IKE): Network Policy Move** screen.

A VPN (Virtual Private Network) tunnel gives you a secure connection to another computer or network. Each VPN tunnel uses a single gateway policy and one or more network policies.

- The gateway policy contains the IKE SA settings. It identifies the IPSec routers at either end of a VPN tunnel.
- The network policy contains the IPSec SA settings. It specifies which devices (behind the IPSec routers) can use the VPN tunnel.

Use this screen to associate a network policy to a gateway policy.

Figure 170 SECURITY > VPN > VPN Rules (IKE) > Move Network Policy

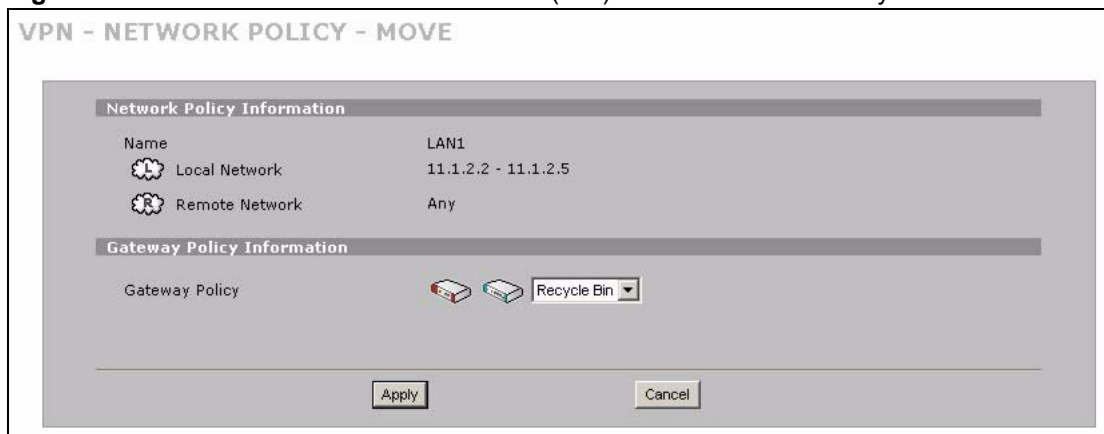

The following table describes the labels in this screen.

Table 67 SECURITY > VPN > VPN Rules (IKE) > Move Network Policy

LABEL	DESCRIPTION
Network Policy Information	The following fields display the general network settings of this VPN policy.
Name	This field displays the policy name.
Local Network	This field displays one or a range of IP address(es) of the computer(s) behind the ZyWALL.
Remote Network	This field displays one or a range of IP address(es) of the remote network behind the remote IPsec router.
Gateway Policy Information	
Gateway Policy	Select the name of a VPN rule (or gateway policy) to which you want to associate this VPN network policy. If you do not want to associate a network policy to any gateway policy, select Recycle Bin from the drop-down list box. The Recycle Bin gateway policy is a virtual placeholder for any network policy(ies) without an associated gateway policy. When there is a network policy in Recycle Bin , the Recycle Bin gateway policy automatically displays in the VPN Rules (IKE) screen.
Apply	Click Apply to save the changes.
Cancel	Click Cancel to discard all changes and return to the main VPN screen.

14.10 IPsec SA Using Manual Keys

You might set up an IPsec SA using manual keys when you want to establish a VPN tunnel quickly, for example, for troubleshooting. You should only do this as a temporary solution, however, because it is not as secure as a regular IPsec SA.

In IPsec SAs using manual keys, the ZyWALL and remote IPsec router do not establish an IKE SA. They only establish an IPsec SA. As a result, an IPsec SA using manual keys has some characteristics of IKE SA and some characteristics of IPsec SA. There are also some differences between IPsec SA using manual keys and other types of SA.

14.10.1 IPsec SA Proposal Using Manual Keys

In IPsec SA using manual keys, you can only specify one encryption algorithm and one authentication algorithm. You cannot specify several proposals. There is no DH key exchange, so you have to provide the encryption key and the authentication key the ZyWALL and remote IPsec router use.



The ZyWALL and remote IPsec router must use the same encryption key and authentication key.

14.10.2 Authentication and the Security Parameter Index (SPI)

For authentication, the ZyWALL and remote IPsec router use the SPI, instead of pre-shared keys, ID type and content. The SPI is an identification number.



The ZyWALL and remote IPsec router must use the same SPI.

14.11 VPN Rules (Manual)

Refer to [Figure 157 on page 235](#) for a graphical representation of the fields in the web configurator.

Click **SECURITY > VPN > VPN Rules (Manual)** to open the **VPN Rules (Manual)** screen.

Use this screen to manage the ZyWALL's list of VPN rules (tunnels) that use manual keys. You may want to configure a VPN rule that uses manual key management if you are having problems with IKE key management.

Figure 171 SECURITY > VPN > VPN Rules (Manual)

#	Name	Active	Local Network	Remote Network	Encap.	IPsec Algorithm	Remote Gateway Address	Modify
1	example	Yes	192.168.1.23 - 192.168.1.23	192.168.2.30 - 192.168.2.30	Tunnel	ESP DES SHA1	172.21.1.100	

Add

The following table describes the labels in this screen.

Table 68 SECURITY > VPN > VPN Rules (Manual)

LABEL	DESCRIPTION
#	This is the VPN policy index number.
Name	This field displays the identification name for this VPN policy.
Active	This field displays whether the VPN policy is active or not. A Yes signifies that this VPN policy is active. No signifies that this VPN policy is not active.
Local Network	This is the IP address(es) of computer(s) on your local network behind your ZyWALL. The same (static) IP address is displayed twice when the Local Network Address Type field in the VPN - Manual Key - Edit screen is configured to Single Address . The beginning and ending (static) IP addresses, in a range of computers are displayed when the Local Network Address Type field in the VPN - Manual Key - Edit screen is configured to Range Address . A (static) IP address and a subnet mask are displayed when the Local Network Address Type field in the VPN - Manual Key - Edit screen is configured to Subnet Address .
Remote Network	This is the IP address(es) of computer(s) on the remote network behind the remote IPSec router. This field displays N/A when the Remote Gateway Address field displays 0.0.0.0 . In this case only the remote IPSec router can initiate the VPN. The same (static) IP address is displayed twice when the Remote Network Address Type field in the VPN - Manual Key - Edit screen is configured to Single Address . The beginning and ending (static) IP addresses, in a range of computers are displayed when the Remote Network Address Type field in the VPN - Manual Key - Edit screen is configured to Range Address . A (static) IP address and a subnet mask are displayed when the Remote Network Address Type field in the VPN - Manual Key - Edit screen is configured to Subnet Address .
Encap.	This field displays Tunnel or Transport mode (Tunnel is the default selection).
IPSec Algorithm	This field displays the security protocols used for an SA. Both AH and ESP increase ZyWALL processing requirements and communications latency (delay).
Remote Gateway Address	This is the static WAN IP address or domain name of the remote IPSec router.
Modify	Click the edit icon to edit the VPN policy. Click the delete icon to remove the VPN policy. A window displays asking you to confirm that you want to delete the VPN rule. When a VPN policy is deleted, subsequent policies move up in the page list.
Add	Click Add to add a new VPN policy.

14.12 VPN Rules (Manual): Edit

Click the edit icon on the **VPN Rules (Manual)** screen to open the following screen. Use this screen to configure VPN rules that use manual keys. Manual key management is useful if you have problems with IKE key management.

Figure 172 SECURITY > VPN > VPN Rules (Manual) > Edit

The following table describes the labels in this screen.

Table 69 SECURITY > VPN > VPN Rules (Manual) > Edit

LABEL	DESCRIPTION
Property	
Active	Select this check box to activate this VPN policy.
Name	Type up to 32 characters to identify this VPN policy. You may use any character, including spaces, but the ZyWALL drops trailing spaces.
Allow NetBIOS Traffic Through IPsec Tunnel	This field is not available when the ZyWALL is in bridge mode. NetBIOS (Network Basic Input/Output System) are TCP or UDP packets that enable a computer to find other computers. It may sometimes be necessary to allow NetBIOS packets to pass through VPN tunnels in order to allow local computers to find computers on the remote network and vice versa. Select this check box to send NetBIOS packets through the VPN connection.

Table 69 SECURITY > VPN > VPN Rules (Manual) > Edit (continued)

LABEL	DESCRIPTION
Local Network	<p>Local IP addresses must be static and correspond to the remote IPsec router's configured remote IP addresses.</p> <p>Two active SAs cannot have the local and remote IP address(es) both the same. Two active SAs can have the same local or remote IP address, but not both. You can configure multiple SAs between the same local and remote IP addresses, as long as only one is active at any time.</p>
Address Type	<p>Use the drop-down list box to choose Single Address, Range Address, or Subnet Address. Select Single Address for a single IP address. Select Range Address for a specific range of IP addresses. Select Subnet Address to specify IP addresses on a network by their subnet mask.</p>
Starting IP Address	<p>When the Address Type field is configured to Single Address, enter a (static) IP address on the LAN behind your ZyWALL. When the Address Type field is configured to Range Address, enter the beginning (static) IP address, in a range of computers on the LAN behind your ZyWALL. When the Address Type field is configured to Subnet Address, this is a (static) IP address on the LAN behind your ZyWALL.</p>
Ending IP Address/Subnet Mask	<p>When the Address Type field is configured to Single Address, this field is N/A. When the Address Type field is configured to Range Address, enter the end (static) IP address, in a range of computers on the LAN behind your ZyWALL. When the Address Type field is configured to Subnet Address, this is a subnet mask on the LAN behind your ZyWALL.</p>
Remote Network	<p>Remote IP addresses must be static and correspond to the remote IPsec router's configured local IP addresses.</p> <p>Two active SAs cannot have the local and remote IP address(es) both the same. Two active SAs can have the same local or remote IP address, but not both. You can configure multiple SAs between the same local and remote IP addresses, as long as only one is active at any time.</p>
Address Type	<p>Use the drop-down list box to choose Single Address, Range Address, or Subnet Address. Select Single Address with a single IP address. Select Range Address for a specific range of IP addresses. Select Subnet Address to specify IP addresses on a network by their subnet mask.</p>
Starting IP Address	<p>When the Address Type field is configured to Single Address, enter a (static) IP address on the network behind the remote IPsec router. When the Addr Type field is configured to Range Address, enter the beginning (static) IP address, in a range of computers on the network behind the remote IPsec router. When the Address Type field is configured to Subnet Address, enter a (static) IP address on the network behind the remote IPsec router.</p>
Ending IP Address/Subnet Mask	<p>When the Address Type field is configured to Single Address, this field is N/A. When the Address Type field is configured to Range Address, enter the end (static) IP address, in a range of computers on the network behind the remote IPsec router. When the Address Type field is configured to Subnet Address, enter a subnet mask on the network behind the remote IPsec router.</p>
Gateway Policy Information	
My ZyWALL	<p>When the ZyWALL is in router mode, enter the WAN IP address or the domain name of your ZyWALL or leave the field set to 0.0.0.0.</p> <p>The ZyWALL uses its current WAN IP address (static or dynamic) in setting up the VPN tunnel if you leave this field as 0.0.0.0. If the WAN connection goes down, the ZyWALL uses the dial backup IP address for the VPN tunnel when using dial backup or the LAN IP address when using traffic redirect.</p> <p>The VPN tunnel has to be rebuilt if this IP address changes.</p> <p>When the ZyWALL is in bridge mode, this field is read-only and displays the ZyWALL's IP address.</p>

Table 69 SECURITY > VPN > VPN Rules (Manual) > Edit (continued)

LABEL	DESCRIPTION
Primary Remote Gateway	Type the WAN IP address or the domain name (up to 31 characters) of the IPsec router with which you're making the VPN connection.
Manual Proposal	
SPI	Type a unique SPI (Security Parameter Index) from one to four characters long. Valid Characters are "0, 1, 2, 3, 4, 5, 6, 7, 8, and 9".
Encapsulation Mode	Select Tunnel mode or Transport mode from the drop-down list box.
Active Protocol	Select ESP if you want to use ESP (Encapsulation Security Payload). The ESP protocol (RFC 2406) provides encryption as well as some of the services offered by AH . If you select ESP here, you must select options from the Encryption Algorithm and Authentication Algorithm fields (described next). Select AH if you want to use AH (Authentication Header Protocol). The AH protocol (RFC 2402) was designed for integrity, authentication, sequence integrity (replay resistance), and non-repudiation but not for confidentiality, for which the ESP was designed. If you select AH here, you must select options from the Authentication Algorithm field (described next).
Encryption Algorithm	Select DES , 3DES or NULL from the drop-down list box. When DES is used for data communications, both sender and receiver must know the Encryption Key , which can be used to encrypt and decrypt the message or to generate and verify a message authentication code. The DES encryption algorithm uses a 56-bit key. Triple DES (3DES) is a variation on DES that uses a 168-bit key. As a result, 3DES is more secure than DES . It also requires more processing power, resulting in increased latency and decreased throughput. Select NULL to set up a tunnel without encryption. When you select NULL , you do not enter an encryption key.
Authentication Algorithm	Select SHA1 or MD5 from the drop-down list box. MD5 (Message Digest 5) and SHA1 (Secure Hash Algorithm) are hash algorithms used to authenticate packet data. The SHA1 algorithm is generally considered stronger than MD5 , but is slower. Select MD5 for minimal security and SHA-1 for maximum security.
Encryption Key	This field is applicable when you select ESP in the Active Protocol field above. With DES , type a unique key 8 characters long. With 3DES , type a unique key 24 characters long. Any characters may be used, including spaces, but trailing spaces are truncated.
Authentication Key	Type a unique authentication key to be used by IPsec if applicable. Enter 16 characters for MD5 authentication or 20 characters for SHA-1 authentication. Any characters may be used, including spaces, but trailing spaces are truncated.
Apply	Click Apply to save your changes back to the ZyWALL.
Cancel	Click Cancel to exit this screen without saving.

14.13 VPN SA Monitor

In the web configurator, click **SECURITY > VPN > SA Monitor**. Use this screen to display and manage active VPN connections.

A Security Association (SA) is the group of security settings related to a specific VPN tunnel. This screen displays active VPN connections. Use **Refresh** to display active VPN connections.

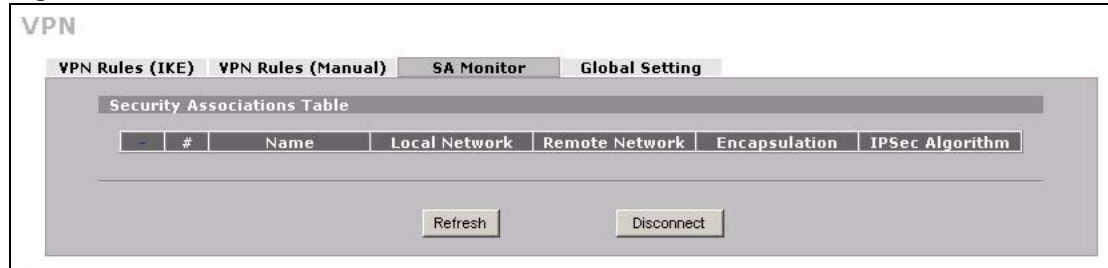
Figure 173 SECURITY > VPN > SA Monitor

The following table describes the labels in this screen.

Table 70 SECURITY > VPN > SA Monitor

LABEL	DESCRIPTION
#	This is the security association index number.
Name	This field displays the identification name for this VPN policy.
Local Network	This field displays the IP address of the computer using the VPN IPSec feature of your ZyWALL.
Remote Network	This field displays IP address (in a range) of computers on the remote network behind the remote IPSec router.
Encapsulation	This field displays Tunnel or Transport mode.
IPSec Algorithm	This field displays the security protocols used for an SA. Both AH and ESP increase ZyWALL processing requirements and communications latency (delay).
Refresh	Click Refresh to display the current active VPN connection(s).
Disconnect	Select a security association index number that you want to disconnect and then click Disconnect .

14.14 VPN Global Setting

Click **SECURITY > VPN > Global Setting** to open the **VPN Global Setting** screen. Use this screen to change settings that apply to all of your VPN tunnels.

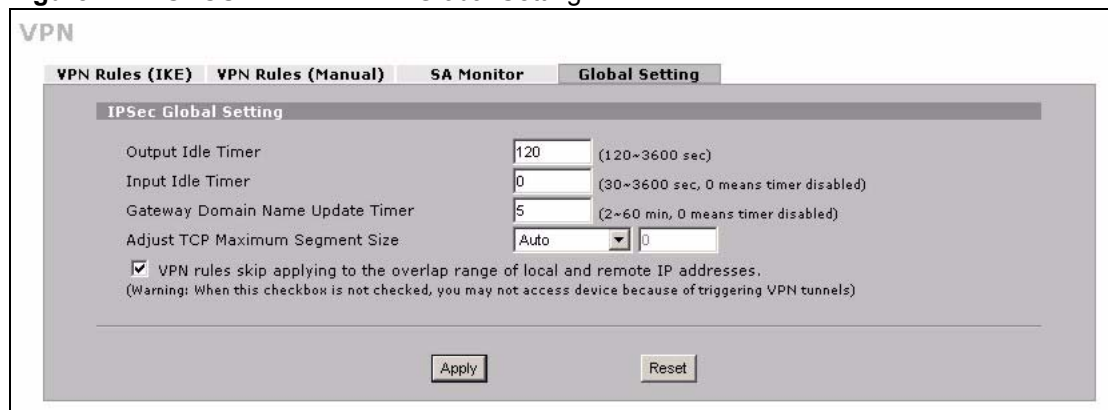
Figure 174 SECURITY > VPN > Global Setting

The following table describes the labels in this screen.

Table 71 SECURITY > VPN > Global Setting

LABEL	DESCRIPTION
Output Idle Timer	<p>When traffic is sent to a remote IPsec router from which no reply is received after the specified time period, the ZyWALL checks the VPN connectivity. If the remote IPsec router does not reply, the ZyWALL automatically disconnects the VPN tunnel.</p> <p>Enter the time period (between 120 and 3600 seconds) to wait before the ZyWALL checks all of the VPN connections to remote IPsec routers.</p> <p>Enter 0 to disable this feature.</p>
Input Idle Timer	<p>When no traffic is received from a remote IPsec router after the specified time period, the ZyWALL checks the VPN connectivity. If the remote IPsec router does not reply, the ZyWALL automatically disconnects the VPN tunnel.</p> <p>Enter the time period (between 30 and 3600 seconds) to wait before the ZyWALL checks all of the VPN connections to remote IPsec routers.</p> <p>Enter 0 to disable this feature.</p>
Gateway Domain Name Update Timer	<p>This field is applicable when you enter a domain name to identify the ZyWALL and/or the remote secure gateway.</p> <p>Enter the time period (between 2 and 60 minutes) to wait before the ZyWALL updates the domain name and IP address mapping through a DNS server. The ZyWALL rebuilds the VPN tunnel if it finds that the domain name is now using a different IP address (any users of the VPN tunnel will be temporarily disconnected).</p> <p>Enter 0 to disable this feature.</p>
Adjust TCP Maximum Segment Size	<p>The TCP packets are larger after the ZyWALL encrypts them for VPN. The ZyWALL fragments packets that are larger than a connection's MTU (Maximum Transmit Unit).</p> <p>In most cases you should leave this set to Auto. The ZyWALL automatically sets the Maximum Segment Size (MSS) of the TCP packets that are to be encrypted by VPN based on the encapsulation type.</p> <p>Select Off to not adjust the MSS for the encrypted TCP packets.</p> <p>If your network environment causes fragmentation issues that are affecting your throughput performance, you can manually set a smaller MSS for the TCP packets that are to be encrypted by VPN. Select User-Defined and specify a size from 0~1460 bytes. 0 has the ZyWALL use the auto setting.</p>
VPN rules skip applying to the overlap range of local and remote IP addresses	<p>Select this check box to send packets destined for overlapping local and remote IP addresses to the local network (you can access the local devices but not the remote devices).</p> <p>Clear this check box to send packets destined for overlapping local and remote IP addresses to the remote network (you can access the remote devices but not the local devices.)</p> <p>If the remote IPsec router also supports NAT over IPsec, it is recommended that you use NAT over IPsec (see Section 14.6.2 on page 250) if the local and remote IP addresses overlap.</p> <p>If a VPN rule's local and remote network settings are both set to 0.0.0.0 (any), no traffic goes through the VPN tunnel if you select this check box.</p>
Apply	Click Apply to save your changes back to the ZyWALL.
Reset	Click Reset to begin configuring this screen afresh.

14.15 Telecommuter VPN/IPSec Examples

The following examples show how multiple telecommuters can make VPN connections to a single ZyWALL at headquarters. The telecommuters use IPSec routers with dynamic WAN IP addresses. The ZyWALL at headquarters has a static public IP address.

14.15.1 Telecommuters Sharing One VPN Rule Example

See the following figure and table for an example configuration that allows multiple telecommuters (A, B and C in the figure) to use one VPN rule to simultaneously access a ZyWALL at headquarters (HQ in the figure). The telecommuters do not have domain names mapped to the WAN IP addresses of their IPSec routers. The telecommuters must all use the same IPSec parameters but the local IP addresses (or ranges of addresses) should not overlap.

Figure 175 Telecommuters Sharing One VPN Rule Example

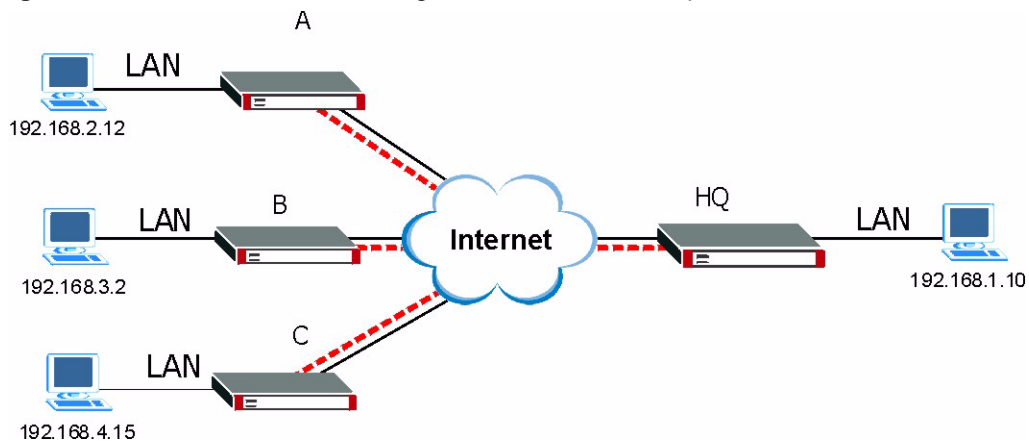

Table 72 Telecommuters Sharing One VPN Rule Example

FIELDS	TELECOMMUTERS	HEADQUARTERS
My ZyWALL:	0.0.0.0 (dynamic IP address assigned by the ISP)	Public static IP address
Remote Gateway Address:	Public static IP address	0.0.0.0 With this IP address only the telecommuter can initiate the IPSec tunnel.
Local Network - Single IP Address:	Telecommuter A: 192.168.2.12 Telecommuter B: 192.168.3.2 Telecommuter C: 192.168.4.15	192.168.1.10
Remote Network - Single IP Address:	192.168.1.10	Not Applicable

14.15.2 Telecommuters Using Unique VPN Rules Example

In this example the telecommuters (A, B and C in the figure) use IPSec routers with domain names that are mapped to their dynamic WAN IP addresses (use Dynamic DNS to do this).

With aggressive negotiation mode (see [Section 14.3.1.4 on page 240](#)), the ZyWALL can use the ID types and contents to distinguish between VPN rules. Telecommuters can each use a separate VPN rule to simultaneously access a ZyWALL at headquarters. They can use different IPsec parameters. The local IP addresses (or ranges of addresses) of the rules configured on the ZyWALL at headquarters can overlap. The local IP addresses of the rules configured on the telecommuters' IPsec routers should not overlap.

See the following table and figure for an example where three telecommuters each use a different VPN rule for a VPN connection with a ZyWALL located at headquarters. The ZyWALL at headquarters (HQ in the figure) identifies each incoming SA by its ID type and content and uses the appropriate VPN rule to establish the VPN connection.

The ZyWALL at headquarters can also initiate VPN connections to the telecommuters since it can find the telecommuters by resolving their domain names.

Figure 176 Telecommuters Using Unique VPN Rules Example

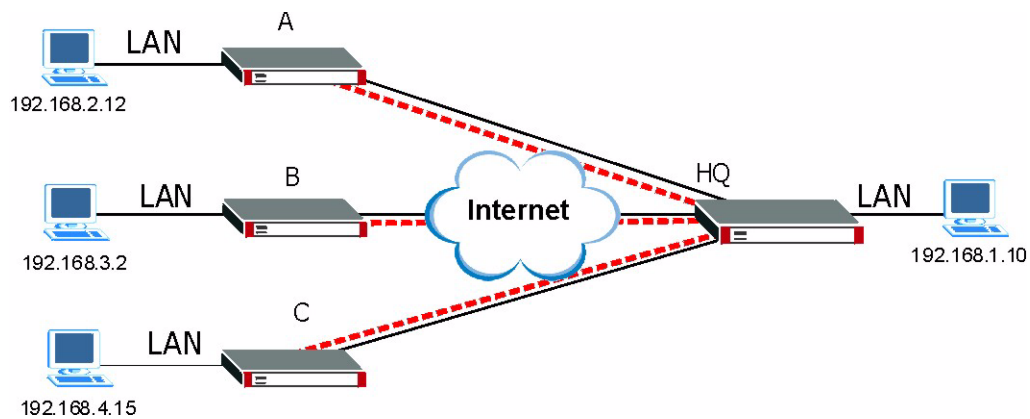

Table 73 Telecommuters Using Unique VPN Rules Example

TELECOMMUTERS	HEADQUARTERS
All Telecommuter Rules:	All Headquarters Rules:
My ZyWALL 0.0.0.0	My ZyWALL: bigcompanyhq.com
Remote Gateway Address: bigcompanyhq.com	Local Network - Single IP Address: 192.168.1.10
Remote Network - Single IP Address: 192.168.1.10	Local ID Type: E-mail
Peer ID Type: E-mail	Local ID Content: bob@bigcompanyhq.com
Peer ID Content: bob@bigcompanyhq.com	
Telecommuter A (telecommutera.dydns.org)	Headquarters ZyWALL Rule 1:
Local ID Type: IP	Peer ID Type: IP
Local ID Content: 192.168.2.12	Peer ID Content: 192.168.2.12
Local IP Address: 192.168.2.12	Remote Gateway Address: telecommutera.dydns.org
	Remote Address 192.168.2.12
Telecommuter B (telecommuterb.dydns.org)	Headquarters ZyWALL Rule 2:

Table 73 Telecommuters Using Unique VPN Rules Example

TELECOMMUTERS	HEADQUARTERS
Local ID Type: DNS	Peer ID Type: DNS
Local ID Content: telecommuterb.com	Peer ID Content: telecommuterb.com
Local IP Address: 192.168.3.2	Remote Gateway Address: telecommuterb.dydns.org
	Remote Address 192.168.3.2
Telecommuter C (telecommuterc.dydns.org)	Headquarters ZyWALL Rule 3:
Local ID Type: E-mail	Peer ID Type: E-mail
Local ID Content: myVPN@myplace.com	Peer ID Content: myVPN@myplace.com
Local IP Address: 192.168.4.15	Remote Gateway Address: telecommuterc.dydns.org
	Remote Address 192.168.4.15

14.16 VPN and Remote Management

You can allow someone to use a service (like Telnet or HTTP) through a VPN tunnel to manage the ZyWALL. One of the ZyWALL's ports must be part of the VPN rule's local network. This can be the ZyWALL's LAN port if you do not want to allow remote management on the WAN port. You also have to configure remote management (**REMOTE MGMT**) to allow management access for the service through the specific port.

In the following example, the VPN rule's local network (A) includes the ZyWALL's LAN IP address of 192.168.1.7. Someone in the remote network (B) can use a service (like HTTP for example) through the VPN tunnel to access the ZyWALL's LAN interface. Remote management must also be configured to allow HTTP access on the ZyWALL's LAN interface.

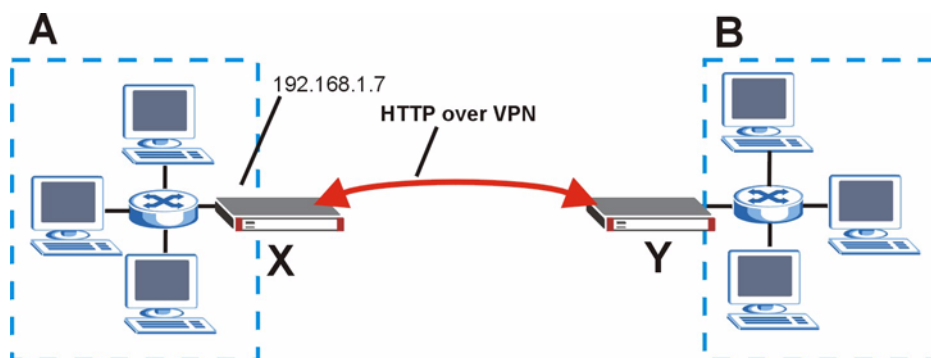
Figure 177 VPN for Remote Management Example

14.17 Hub-and-spoke VPN

Hub-and-spoke VPN connects VPN tunnels to form one secure network.

Figure 178 on page 269 shows some example network topologies. In the first (fully-meshed) approach, there is a VPN connection between every pair of routers. In the second (hub-and-spoke) approach, there is a VPN connection between each spoke router (B, C, D, and E) and the hub router (A). The hub router routes VPN traffic between the spoke routers and itself.

Figure 178 VPN Topologies

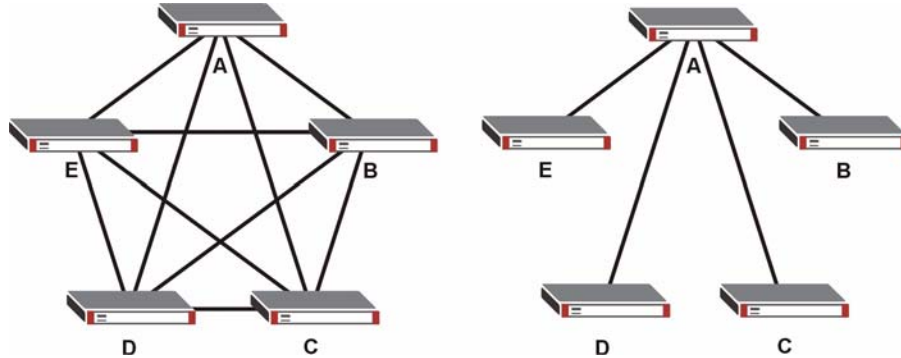

Hub-and-spoke VPN reduces the number of VPN connections that you have to set up and maintain in the network. Small office or telecommuter IPsec routers that support a limited number of VPN tunnels are also able to use VPN to connect to more networks. Hub-and-spoke VPN makes it easier for the hub router to manage the traffic between the spoke routers. If you have the spoke routers access the Internet through the hub-and-spoke VPN tunnel, the hub router can also provide content filtering protection for the spoke routers.

You should not use a hub-and-spoke VPN in every situation, however. The hub router is a single point of failure, so a hub-and-spoke VPN may not be appropriate if the connection between the spoke routers cannot be down occasionally (for maintenance, for example). In addition, there is a significant burden on the hub router. It receives VPN traffic from one spoke, decrypts it, inspects it to find out where to send it, encrypts it, and sends it to the appropriate spoke. Therefore, a hub-and-spoke VPN is more suitable when there is a minimum amount of traffic between spoke routers.

14.17.1 Hub-and-spoke VPN Example

The following figure shows a basic hub-and-spoke VPN. Branch office A uses one VPN rule to access both the headquarters (HQ) network and branch office B's network. Branch office B uses one VPN rule to access both the headquarters and branch office A's networks.

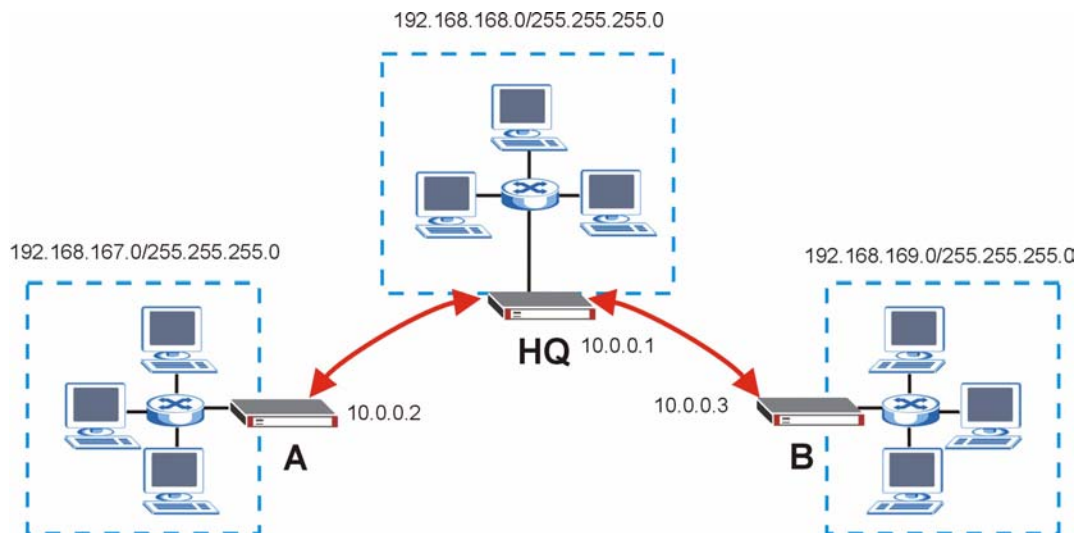
Figure 179 Hub-and-spoke VPN Example

14.17.2 Hub-and-spoke Example VPN Rule Addresses

The VPN rules for this hub-and-spoke example would use the following address settings.

Branch Office A:

- Remote Gateway: 10.0.0.1
- Local IP address: 192.168.167.0/255.255.255.0
- Remote IP address: 192.168.168.0~192.168.169.255

Headquarters:

Rule 1:

- Remote Gateway: 10.0.0.2
- Local IP address: 192.168.168.0~192.168.169.255
- Remote IP address: 192.168.167.0/255.255.255.0

Rule 2:

- Remote Gateway: 10.0.0.3
- Local IP address: 192.168.167.0~192.168.168.255
- Remote IP address: 192.168.169.0/255.255.255.0

Branch Office B:

- Remote Gateway: 10.0.0.1
- Local IP address: 192.168.169.0/255.255.255.0
- Remote IP address: 192.168.167.0~192.168.168.255

14.17.3 Hub-and-spoke VPN Requirements and Suggestions

Consider the following when implementing a hub-and-spoke VPN.

The local IP addresses configured in the VPN rules cannot overlap

The hub router must have at least one separate VPN rule for each spoke. In the local IP address, specify the IP addresses of the hub-and-spoke networks with which the spoke is to be able to have a VPN tunnel. This may require you to use more than one VPN rule.

If you want to have the spoke routers access the Internet through the hub-and-spoke VPN tunnel, set the VPN rules in the spoke routers to use 0.0.0.0 (any) as the remote IP address.

Make sure that your **From VPN** and **To VPN** firewall rules do not block the VPN packets.

Certificates

This chapter gives background information about public-key certificates and explains how to use them.

15.1 Certificates Overview

The ZyWALL can use certificates (also called digital IDs) to authenticate users. Certificates are based on public-private key pairs. A certificate contains the certificate owner's identity and public key. Certificates provide a way to exchange public keys for use in authentication.

A Certification Authority (CA) issues certificates and guarantees the identity of each certificate owner. There are commercial certification authorities like CyberTrust or VeriSign and government certification authorities. You can use the ZyWALL to generate certification requests that contain identifying information and public keys and then send the certification requests to a certification authority.

In public-key encryption and decryption, each host has two keys. One key is public and can be made openly available; the other key is private and must be kept secure. Public-key encryption in general works as follows.

- 1 Tim wants to send a private message to Jenny. Tim generates a public-private key pair. What is encrypted with one key can only be decrypted using the other.
- 2 Tim keeps the private key and makes the public key openly available.
- 3 Tim uses his private key to encrypt the message and sends it to Jenny.
- 4 Jenny receives the message and uses Tim's public key to decrypt it.
- 5 Additionally, Jenny uses her own private key to encrypt a message and Tim uses Jenny's public key to decrypt the message.

The ZyWALL uses certificates based on public-key cryptology to authenticate users attempting to establish a connection, not to encrypt the data that you send after establishing a connection. The method used to secure the data that you send through an established connection depends on the type of connection. For example, a VPN tunnel might use the triple DES encryption algorithm.

The certification authority uses its private key to sign certificates. Anyone can then use the certification authority's public key to verify the certificates.

A certification path is the hierarchy of certification authority certificates that validate a certificate. The ZyWALL does not trust a certificate if any certificate on its path has expired or been revoked.

Certification authorities maintain directory servers with databases of valid and revoked certificates. A directory of certificates that have been revoked before the scheduled expiration is called a CRL (Certificate Revocation List). The ZyWALL can check a peer's certificate against a directory server's list of revoked certificates. The framework of servers, software, procedures and policies that handles keys is called PKI (public-key infrastructure).

15.1.1 Advantages of Certificates

Certificates offer the following benefits.

- The ZyWALL only has to store the certificates of the certification authorities that you decide to trust, no matter how many devices you need to authenticate.
- Key distribution is simple and very secure since you can freely distribute public keys and you never need to transmit private keys.

15.2 Self-signed Certificates

You can have the ZyWALL act as a certification authority and sign its own certificates.

15.3 Verifying a Certificate

Before you import a trusted CA or trusted remote host certificate into the ZyWALL, you should verify that you have the actual certificate. This is especially true of trusted CA certificates since the ZyWALL also trusts any valid certificate signed by any of the imported trusted CA certificates.

15.3.1 Checking the Fingerprint of a Certificate on Your Computer

A certificate's fingerprints are message digests calculated using the MD5 or SHA1 algorithms. The following procedure describes how to check a certificate's fingerprint to verify that you have the actual certificate.

- 1 Browse to where you have the certificate saved on your computer.
- 2 Make sure that the certificate has a ".cer" or ".crt" file name extension.

Figure 180 Certificates on Your Computer

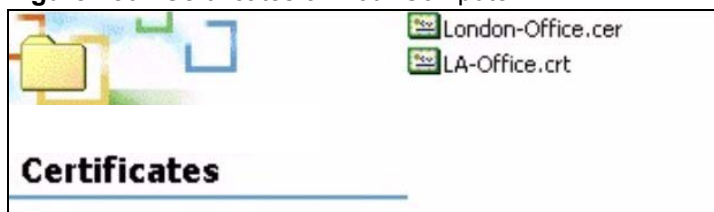

- 3 Double-click the certificate's icon to open the **Certificate** window. Click the **Details** tab and scroll down to the **Thumbprint Algorithm** and **Thumbprint** fields.

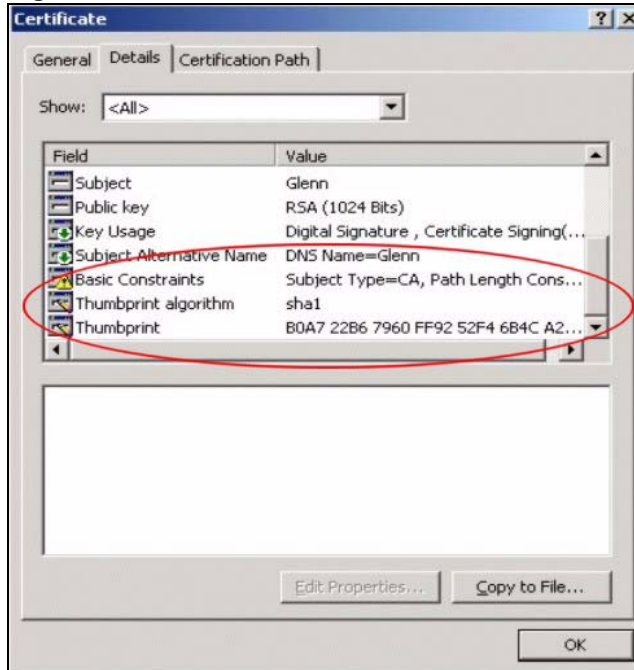
Figure 181 Certificate Details

- 4 Use a secure method to verify that the certificate owner has the same information in the **Thumbprint Algorithm** and **Thumbprint** fields. The secure method may very based on your situation. Possible examples would be over the telephone or through an HTTPS connection.

15.4 Configuration Summary

This section summarizes how to manage certificates on the ZyWALL.

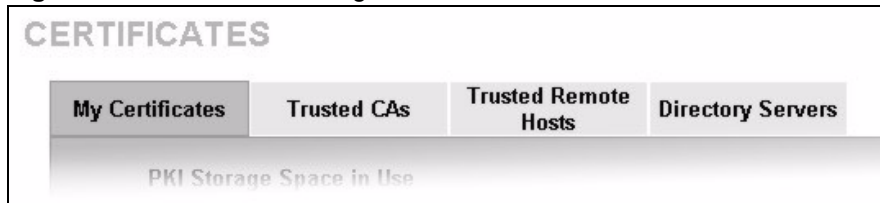
Figure 182 Certificate Configuration Overview

Use the **My Certificate** screens to generate and export self-signed certificates or certification requests and import the ZyWALL's CA-signed certificates.

Use the **Trusted CA** screens to save the certificates of trusted CAs to the ZyWALL. You can also export the certificates to a computer.

Use the **Trusted Remote Hosts** screens to import self-signed certificates from trusted remote hosts.

Use the **Directory Servers** screen to configure a list of addresses of directory servers (that contain lists of valid and revoked certificates).

15.5 My Certificates

Click **SECURITY > CERTIFICATES > My Certificates** to open the **My Certificates** screen. This is the ZyWALL's summary list of certificates and certification requests. Certificates display in black and certification requests display in gray.

Figure 183 SECURITY > CERTIFICATES > My Certificates

CERTIFICATES

My Certificates Trusted CAs Trusted Remote Hosts Directory Servers

PKI Storage Space in Use

0% 28% 100%

Replace Factory Default Certificate

Factory Default Certificate Name: auto_generated_self_signed_cert

The factory default certificate is common to all ZyWALL models. Click Replace to create a certificate using your ZyWALL's MAC address that will be specific to this device.

Replace

My Certificates

#	Name	Type	Subject	Issuer	Valid From	Valid To	Modify
1	auto_generated_self_signed_cert	*SELF	CN=ZyWALL 2 Plus Factory Default Certificate	CN=ZyWALL 2 Plus Factory Default Certificate	2000 Jan 1st, 00:00:00 GMT	2030 Jan 1st, 00:00:00 GMT	[Icons]
2	test	REQ	CN=0.0.0.0	N/A	N/A	N/A	[Icons]

Import Create Refresh

The following table describes the labels in this screen.

Table 74 SECURITY > CERTIFICATES > My Certificates

LABEL	DESCRIPTION
PKI Storage Space in Use	This bar displays the percentage of the ZyWALL's PKI storage space that is currently in use. When the storage space is almost full, you should consider deleting expired or unnecessary certificates before adding more certificates.
Replace	This button displays when the ZyWALL has the factory default certificate. The factory default certificate is common to all ZyWALLs that use certificates. ZyXEL recommends that you use this button to replace the factory default certificate with one that uses your ZyWALL's MAC address.
#	This field displays the certificate index number. The certificates are listed in alphabetical order.
Name	This field displays the name used to identify this certificate. It is recommended that you give each certificate a unique name.
Type	This field displays what kind of certificate this is. REQ represents a certification request and is not yet a valid certificate. Send a certification request to a certification authority, which then issues a certificate. Use the My Certificate Import screen to import the certificate and replace the request. SELF represents a self-signed certificate. *SELF represents the default self-signed certificate, which the ZyWALL uses to sign imported trusted remote host certificates. CERT represents a certificate issued by a certification authority.
Subject	This field displays identifying information about the certificate's owner, such as CN (Common Name), OU (Organizational Unit or department), O (Organization or company) and C (Country). It is recommended that each certificate have unique subject information.

Table 74 SECURITY > CERTIFICATES > My Certificates (continued)

LABEL	DESCRIPTION
Issuer	This field displays identifying information about the certificate's issuing certification authority, such as a common name, organizational unit or department, organization or company and country. With self-signed certificates, this is the same information as in the Subject field.
Valid From	This field displays the date that the certificate becomes applicable. The text displays in red and includes a Not Yet Valid! message if the certificate has not yet become applicable.
Valid To	This field displays the date that the certificate expires. The text displays in red and includes an Expiring! or Expired! message if the certificate is about to expire or has already expired.
Modify	<p>Click the details icon to open a screen with an in-depth list of information about the certificate (or certification request).</p> <p>Click the export icon to save the certificate to a computer. For a certification request, click the export icon and then Save in the File Download screen. The Save As screen opens, browse to the location that you want to use and click Save.</p> <p>Click the delete icon to remove the certificate (or certification request). A window displays asking you to confirm that you want to delete the certificate. You cannot delete a certificate that one or more features is configured to use. Do the following to delete a certificate that shows *SELF in the Type field.</p> <ol style="list-style-type: none"> 1. Make sure that no other features, such as HTTPS, VPN, SSH are configured to use the *SELF certificate. 2. Click the details icon next to another self-signed certificate (see the description on the Create button if you need to create a self-signed certificate). 3. Select the Default self-signed certificate which signs the imported remote host certificates check box. 4. Click Apply to save the changes and return to the My Certificates screen. 5. The certificate that originally showed *SELF displays SELF and you can delete it now. <p>Note that subsequent certificates move up by one when you take this action</p>
Import	Click Import to open a screen where you can save the certificate that you have enrolled from a certification authority from your computer to the ZyWALL.
Create	Click Create to go to the screen where you can have the ZyWALL generate a certificate or a certification request.
Refresh	Click Refresh to display the current validity status of the certificates.

15.6 My Certificate Details

Click **SECURITY > CERTIFICATES > My Certificates** to open the **My Certificates** screen (see [Figure 183 on page 276](#)). Click the details icon to open the **My Certificate Details** screen. You can use this screen to view in-depth certificate information and change the certificate's name.

If it is a self-signed certificate, you can also set the ZyWALL to use the certificate to sign the imported trusted remote host certificates.

Figure 184 SECURITY > CERTIFICATES > My Certificates > Details

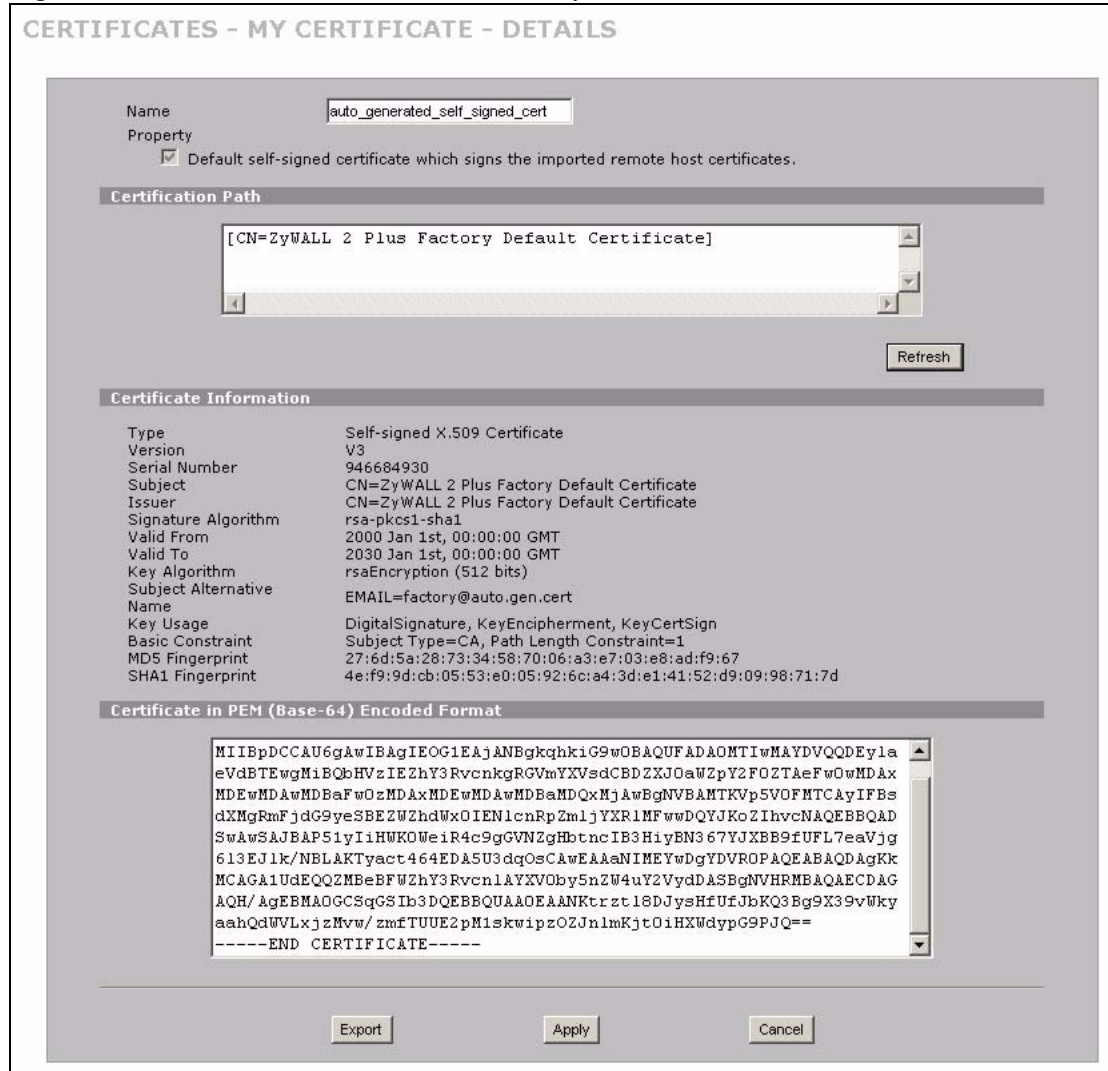

The following table describes the labels in this screen.

Table 75 SECURITY > CERTIFICATES > My Certificates > Details

LABEL	DESCRIPTION
Name	This field displays the identifying name of this certificate. If you want to change the name, type up to 31 characters to identify this certificate. You may use any character (not including spaces).
Property Default self-signed certificate which signs the imported remote host certificates.	Select this check box to have the ZyWALL use this certificate to sign the trusted remote host certificates that you import to the ZyWALL. This check box is only available with self-signed certificates. If this check box is already selected, you cannot clear it in this screen, you must select this check box in another self-signed certificate's details screen. This automatically clears the check box in the details screen of the certificate that was previously set to sign the imported trusted remote host certificates.

Table 75 SECURITY > CERTIFICATES > My Certificates > Details (continued)

LABEL	DESCRIPTION
Certification Path	Click the Refresh button to have this read-only text box display the hierarchy of certification authorities that validate the certificate (and the certificate itself). If the issuing certification authority is one that you have imported as a trusted certification authority, it may be the only certification authority in the list (along with the certificate itself). If the certificate is a self-signed certificate, the certificate itself is the only one in the list. The ZyWALL does not trust the certificate and displays “Not trusted” in this field if any certificate on the path has expired or been revoked.
Refresh	Click Refresh to display the certification path.
Certificate Information	These read-only fields display detailed information about the certificate.
Type	This field displays general information about the certificate. CA-signed means that a Certification Authority signed the certificate. Self-signed means that the certificate’s owner signed the certificate (not a certification authority). “X.509” means that this certificate was created and signed according to the ITU-T X.509 recommendation that defines the formats for public-key certificates.
Version	This field displays the X.509 version number.
Serial Number	This field displays the certificate’s identification number given by the certification authority or generated by the ZyWALL.
Subject	This field displays information that identifies the owner of the certificate, such as Common Name (CN), Organizational Unit (OU), Organization (O) and Country (C).
Issuer	This field displays identifying information about the certificate’s issuing certification authority, such as Common Name, Organizational Unit, Organization and Country. With self-signed certificates, this is the same as the Subject Name field.
Signature Algorithm	This field displays the type of algorithm that was used to sign the certificate. The ZyWALL uses rsa-pkcs1-sha1 (RSA public-private key encryption algorithm and the SHA1 hash algorithm). Some certification authorities may use rsa-pkcs1-md5 (RSA public-private key encryption algorithm and the MD5 hash algorithm).
Valid From	This field displays the date that the certificate becomes applicable. The text displays in red and includes a Not Yet Valid! message if the certificate has not yet become applicable.
Valid To	This field displays the date that the certificate expires. The text displays in red and includes an Expiring! or Expired! message if the certificate is about to expire or has already expired.
Key Algorithm	This field displays the type of algorithm that was used to generate the certificate’s key pair (the ZyWALL uses RSA encryption) and the length of the key set in bits (1024 bits for example).
Subject Alternative Name	This field displays the certificate owner’s IP address (IP), domain name (DNS) or e-mail address (EMAIL).
Key Usage	This field displays for what functions the certificate’s key can be used. For example, “DigitalSignature” means that the key can be used to sign certificates and “KeyEncipherment” means that the key can be used to encrypt text.
Basic Constraint	This field displays general information about the certificate. For example, Subject Type=CA means that this is a certification authority’s certificate and “Path Length Constraint=1” means that there can only be one certification authority in the certificate’s path.
MD5 Fingerprint	This is the certificate’s message digest that the ZyWALL calculated using the MD5 algorithm.

Table 75 SECURITY > CERTIFICATES > My Certificates > Details (continued)

LABEL	DESCRIPTION
SHA1 Fingerprint	This is the certificate's message digest that the ZyWALL calculated using the SHA1 algorithm.
Certificate in PEM (Base-64) Encoded Format	<p>This read-only text box displays the certificate or certification request in Privacy Enhanced Mail (PEM) format. PEM uses 64 ASCII characters to convert the binary certificate into a printable form.</p> <p>You can copy and paste a certification request into a certification authority's web page, an e-mail that you send to the certification authority or a text editor and save the file on a management computer for later manual enrollment.</p> <p>You can copy and paste a certificate into an e-mail to send to friends or colleagues or you can copy and paste a certificate into a text editor and save the file on a management computer for later distribution (via floppy disk for example).</p>
Apply	Click Apply to save your changes back to the ZyWALL. You can only change the name, except in the case of a self-signed certificate, which you can also set to be the default self-signed certificate that signs the imported trusted remote host certificates.
Cancel	Click Cancel to quit and return to the My Certificates screen.

15.7 My Certificate Export

Click **SECURITY > CERTIFICATES > My Certificates** and then a certificate's export icon to open the **My Certificate Export** screen. Follow the instructions in this screen to choose the file format to use for saving the certificate from the ZyWALL to a computer.

15.7.1 Certificate File Export Formats

You can export a certificate in one of these file formats:

- **Binary X.509:** This is an ITU-T recommendation that defines the formats for X.509 certificates.
- **Binary PKCS#12:** This is a format for transferring public key and private key certificates. The private key in a PKCS #12 file is within a password-encrypted envelope. The file's password is not connected to your certificate's public or private passwords. Exporting a PKCS #12 file creates this and you must provide it to decrypt the contents when you import the file into the ZyWALL.

Figure 185 SECURITY > CERTIFICATES > My Certificates > Export

The following table describes the labels in this screen.

Table 76 SECURITY > CERTIFICATES > My Certificates > Export

LABEL	DESCRIPTION
Export the certificate in binary X.509 format.	Binary X.509 is an ITU-T recommendation that defines the formats for X.509 certificates.
Export the certificate along with the corresponding private key in PKCS#12 format.	PKCS#12 is a format for transferring public key and private key certificates. You can also password-encrypt the private key in the PKCS #12 file. The file's password is not connected to your certificate's public or private passwords.
Password	Type the file's password to use for encrypting the private key. The password is optional, although you must specify one if you want to be able to import the PKCS#12 format certificate into Netscape version 7.2.
Retype to confirm	Type the password to make sure that you have entered it correctly.
Apply	Click Apply and then Save in the File Download screen. The Save As screen opens, browse to the location that you want to use and click Save .
Cancel	Click Cancel to quit and return to the My Certificates screen.

15.8 My Certificate Import

Click **SECURITY > CERTIFICATES > My Certificates** and then **Import** to open the **My Certificate Import** screen. Follow the instructions in this screen to save an existing certificate from a computer to the ZyWALL.

- You can only import a certificate that matches a corresponding certification request that was generated by the ZyWALL (the certification request contains the private key). The certificate you import replaces the corresponding request in the My Certificates screen. One exception is that you can import a PKCS#12 format certificate without a corresponding certification request since the certificate includes the private key.
- You must remove any spaces from the certificate's filename before you can import it.

15.8.1 Certificate File Formats

The certification authority certificate that you want to import has to be in one of these file formats:

- Binary X.509: This is an ITU-T recommendation that defines the formats for X.509 certificates.
- PEM (Base-64) encoded X.509: This Privacy Enhanced Mail format uses 64 ASCII characters to convert a binary X.509 certificate into a printable form.
- Binary PKCS#7: This is a standard that defines the general syntax for data (including digital signatures) that may be encrypted. The ZyWALL currently allows the importation of a PKCS#7 file that contains a single certificate.
- PEM (Base-64) encoded PKCS#7: This Privacy Enhanced Mail (PEM) format uses 64 ASCII characters to convert a binary PKCS#7 certificate into a printable form.
- Binary PKCS#12: This is a format for transferring public key and private key certificates. The private key in a PKCS #12 file is within a password-encrypted envelope. The file's password is not connected to your certificate's public or private passwords. Exporting a PKCS #12 file creates this and you must provide it to decrypt the contents when you import the file into the ZyWALL.



Be careful to not convert a binary file to text during the transfer process. It is easy for this to occur since many programs use text files by default.

Figure 186 SECURITY > CERTIFICATES > My Certificates > Import

The following table describes the labels in this screen.

Table 77 SECURITY > CERTIFICATES > My Certificates > Import

LABEL	DESCRIPTION
File Path	Type in the location of the file you want to upload in this field or click Browse to find it.
Browse	Click Browse to find the certificate file you want to upload.

Table 77 SECURITY > CERTIFICATES > My Certificates > Import

LABEL	DESCRIPTION
Apply	Click Apply to save the certificate on the ZyWALL.
Cancel	Click Cancel to quit and return to the My Certificates screen.

When you import a binary PKCS#12 format certificate, another screen displays for you to enter the password.

Figure 187 SECURITY > CERTIFICATES > My Certificates > Import: PKCS#12

The following table describes the labels in this screen.

Table 78 SECURITY > CERTIFICATES > My Certificates > Import: PKCS#12

LABEL	DESCRIPTION
Password	Type the file's password that was created when the PKCS #12 file was exported.
Apply	Click Apply to save the certificate on the ZyWALL.
Cancel	Click Cancel to quit and return to the My Certificates screen.

15.9 My Certificate Create

Click **SECURITY > CERTIFICATES > My Certificates > Create** to open the **My Certificate Create** screen. Use this screen to have the ZyWALL create a self-signed certificate, enroll a certificate with a certification authority or generate a certification request.

Figure 188 SECURITY > CERTIFICATES > My Certificates > Create

CERTIFICATES - MY CERTIFICATE - CREATE

Certificate Name

Subject Information

Common Name

Host IP Address

Host Domain Name

E-Mail

Organizational Unit

Organization

Country

Key Length bits

Enrollment Options

Create a self-signed certificate

Create a certification request and save it locally for later manual enrollment

Create a certification request and enroll for a certificate immediately online

Enrollment Protocol

CA Server Address

CA Certificate (See [Trusted CAs](#))

Request Authentication Key

The following table describes the labels in this screen.

Table 79 SECURITY > CERTIFICATES > My Certificates > Create

LABEL	DESCRIPTION
Certificate Name	Type up to 31 ASCII characters (not including spaces) to identify this certificate.
Subject Information	Use these fields to record information that identifies the owner of the certificate. You do not have to fill in every field, although the Common Name is mandatory. The certification authority may add fields (such as a serial number) to the subject information when it issues a certificate. It is recommended that each certificate have unique subject information.
Common Name	Select a radio button to identify the certificate's owner by IP address, domain name or e-mail address. Type the IP address (in dotted decimal notation), domain name or e-mail address in the field provided. The domain name or e-mail address can be up to 31 ASCII characters. The domain name or e-mail address is for identification purposes only and can be any string.
Organizational Unit	Type up to 127 characters to identify the organizational unit or department to which the certificate owner belongs. You may use any character, including spaces, but the ZyWALL drops trailing spaces.
Organization	Type up to 127 characters to identify the company or group to which the certificate owner belongs. You may use any character, including spaces, but the ZyWALL drops trailing spaces.

Table 79 SECURITY > CERTIFICATES > My Certificates > Create (continued)

LABEL	DESCRIPTION
Country	Type up to 127 characters to identify the nation where the certificate owner is located. You may use any character, including spaces, but the ZyWALL drops trailing spaces.
Key Length	Select a number from the drop-down list box to determine how many bits the key should use (512 to 2048). The longer the key, the more secure it is. A longer key also uses more PKI storage space.
Enrollment Options	These radio buttons deal with how and when the certificate is to be generated.
Create a self-signed certificate	Select Create a self-signed certificate to have the ZyWALL generate the certificate and act as the Certification Authority (CA) itself. This way you do not need to apply to a certification authority for certificates.
Create a certification request and save it locally for later manual enrollment	Select Create a certification request and save it locally for later manual enrollment to have the ZyWALL generate and store a request for a certificate. Use the My Certificate Details screen to view the certification request and copy it to send to the certification authority. Copy the certification request from the My Certificate Details screen (see Section 15.6 on page 277) and then send it to the certification authority.
Create a certification request and enroll for a certificate immediately online	Select Create a certification request and enroll for a certificate immediately online to have the ZyWALL generate a request for a certificate and apply to a certification authority for a certificate. You must have the certification authority's certificate already imported in the Trusted CAs screen. When you select this option, you must select the certification authority's enrollment protocol and the certification authority's certificate from the drop-down list boxes and enter the certification authority's server address. You also need to fill in the Reference Number and Key if the certification authority requires them.
Enrollment Protocol	Select the certification authority's enrollment protocol from the drop-down list box. Simple Certificate Enrollment Protocol (SCEP) is a TCP-based enrollment protocol that was developed by VeriSign and Cisco. Certificate Management Protocol (CMP) is a TCP-based enrollment protocol that was developed by the Public Key Infrastructure X.509 working group of the Internet Engineering Task Force (IETF) and is specified in RFC 2510.
CA Server Address	Enter the IP address (or URL) of the certification authority server.
CA Certificate	Select the certification authority's certificate from the CA Certificate drop-down list box. You must have the certification authority's certificate already imported in the Trusted CAs screen. Click Trusted CAs to go to the Trusted CAs screen where you can view (and manage) the ZyWALL's list of certificates of trusted certification authorities.
Request Authentication	When you select Create a certification request and enroll for a certificate immediately online , the certification authority may want you to include a reference number and key to identify you when you send a certification request. Fill in both the Reference Number and the Key fields if your certification authority uses CMP enrollment protocol. Just fill in the Key field if your certification authority uses the SCEP enrollment protocol.
Key	Type the key that the certification authority gave you.
Apply	Click Apply to begin certificate or certification request generation.
Cancel	Click Cancel to quit and return to the My Certificates screen.

After you click **Apply** in the **My Certificate Create** screen, you see a screen that tells you the ZyWALL is generating the self-signed certificate or certification request.

After the ZyWALL successfully enrolls a certificate or generates a certification request or a self-signed certificate, you see a screen with a **Return** button that takes you back to the **My Certificates** screen.

If you configured the **My Certificate Create** screen to have the ZyWALL enroll a certificate and the certificate enrollment is not successful, you see a screen with a **Return** button that takes you back to the **My Certificate Create** screen. Click **Return** and check your information in the **My Certificate Create** screen. Make sure that the certification authority information is correct and that your Internet connection is working properly if you want the ZyWALL to enroll a certificate online.

15.10 Trusted CAs

Click **SECURITY > CERTIFICATES > Trusted CAs** to open the **Trusted CAs** screen. This screen displays a summary list of certificates of the certification authorities that you have set the ZyWALL to accept as trusted. The ZyWALL accepts any valid certificate signed by a certification authority on this list as being trustworthy; thus you do not need to import any certificate that is signed by one of these certification authorities.

Figure 189 SECURITY > CERTIFICATES > Trusted CAs

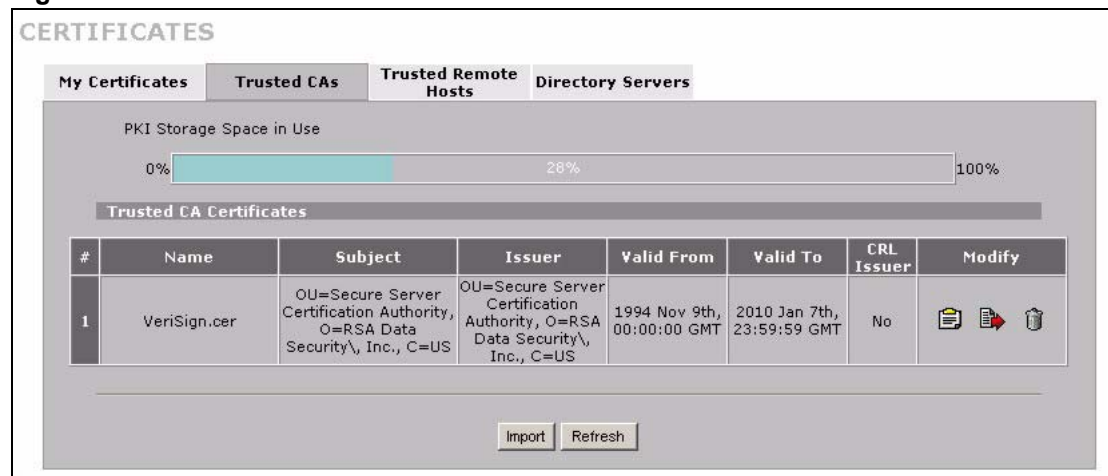

The following table describes the labels in this screen.

Table 80 SECURITY > CERTIFICATES > Trusted CAs

LABEL	DESCRIPTION
PKI Storage Space in Use	This bar displays the percentage of the ZyWALL's PKI storage space that is currently in use. When the storage space is almost full, you should consider deleting expired or unnecessary certificates before adding more certificates.
#	This field displays the certificate index number. The certificates are listed in alphabetical order.
Name	This field displays the name used to identify this certificate.
Subject	This field displays identifying information about the certificate's owner, such as CN (Common Name), OU (Organizational Unit or department), O (Organization or company) and C (Country). It is recommended that each certificate have unique subject information.

Table 80 SECURITY > CERTIFICATES > Trusted CAs (continued)

LABEL	DESCRIPTION
Issuer	This field displays identifying information about the certificate's issuing certification authority, such as a common name, organizational unit or department, organization or company and country. With self-signed certificates, this is the same information as in the Subject field.
Valid From	This field displays the date that the certificate becomes applicable. The text displays in red and includes a Not Yet Valid! message if the certificate has not yet become applicable.
Valid To	This field displays the date that the certificate expires. The text displays in red and includes an Expiring! or Expired! message if the certificate is about to expire or has already expired.
CRL Issuer	This field displays Yes if the certification authority issues Certificate Revocation Lists for the certificates that it has issued and you have selected the Issues certificate revocation lists (CRL) check box in the certificate's details screen to have the ZyWALL check the CRL before trusting any certificates issued by the certification authority. Otherwise the field displays "No".
Modify	Click the details icon to open a screen with an in-depth list of information about the certificate. Use the export icon to save the certificate to a computer. Click the icon and then Save in the File Download screen. The Save As screen opens, browse to the location that you want to use and click Save . Click the delete icon to remove the certificate. A window displays asking you to confirm that you want to delete the certificates. Note that subsequent certificates move up by one when you take this action.
Import	Click Import to open a screen where you can save the certificate of a certification authority that you trust, from your computer to the ZyWALL.
Refresh	Click this button to display the current validity status of the certificates.

15.11 Trusted CA Details

Click **SECURITY > CERTIFICATES > Trusted CAs** to open the **Trusted CAs** screen. Click the details icon to open the **Trusted CA Details** screen. Use this screen to view in-depth information about the certification authority's certificate, change the certificate's name and set whether or not you want the ZyWALL to check a certification authority's list of revoked certificates before trusting a certificate issued by the certification authority.

Table 81 SECURITY > CERTIFICATES > Trusted CAs > Details (continued)

LABEL	DESCRIPTION
Certificate Information	These read-only fields display detailed information about the certificate.
Type	This field displays general information about the certificate. CA-signed means that a Certification Authority signed the certificate. Self-signed means that the certificate's owner signed the certificate (not a certification authority). X.509 means that this certificate was created and signed according to the ITU-T X.509 recommendation that defines the formats for public-key certificates.
Version	This field displays the X.509 version number.
Serial Number	This field displays the certificate's identification number given by the certification authority.
Subject	This field displays information that identifies the owner of the certificate, such as Common Name (CN), Organizational Unit (OU), Organization (O) and Country (C).
Issuer	This field displays identifying information about the certificate's issuing certification authority, such as Common Name, Organizational Unit, Organization and Country. With self-signed certificates, this is the same information as in the Subject Name field.
Signature Algorithm	This field displays the type of algorithm that was used to sign the certificate. Some certification authorities use rsa-pkcs1-sha1 (RSA public-private key encryption algorithm and the SHA1 hash algorithm). Other certification authorities may use rsa-pkcs1-md5 (RSA public-private key encryption algorithm and the MD5 hash algorithm).
Valid From	This field displays the date that the certificate becomes applicable. The text displays in red and includes a Not Yet Valid! message if the certificate has not yet become applicable.
Valid To	This field displays the date that the certificate expires. The text displays in red and includes an Expiring! or Expired! message if the certificate is about to expire or has already expired.
Key Algorithm	This field displays the type of algorithm that was used to generate the certificate's key pair (the ZyWALL uses RSA encryption) and the length of the key set in bits (1024 bits for example).
Subject Alternative Name	This field displays the certificate's owner's IP address (IP), domain name (DNS) or e-mail address (EMAIL).
Key Usage	This field displays for what functions the certificate's key can be used. For example, "DigitalSignature" means that the key can be used to sign certificates and "KeyEncipherment" means that the key can be used to encrypt text.
Basic Constraint	This field displays general information about the certificate. For example, Subject Type=CA means that this is a certification authority's certificate and "Path Length Constraint=1" means that there can only be one certification authority in the certificate's path.
CRL Distribution Points	This field displays how many directory servers with Lists of revoked certificates the issuing certification authority of this certificate makes available. This field also displays the domain names or IP addresses of the servers.
MD5 Fingerprint	This is the certificate's message digest that the ZyWALL calculated using the MD5 algorithm. You can use this value to verify with the certification authority (over the phone for example) that this is actually their certificate.
SHA1 Fingerprint	This is the certificate's message digest that the ZyWALL calculated using the SHA1 algorithm. You can use this value to verify with the certification authority (over the phone for example) that this is actually their certificate.

Table 81 SECURITY > CERTIFICATES > Trusted CAs > Details (continued)

LABEL	DESCRIPTION
Certificate in PEM (Base-64) Encoded Format	This read-only text box displays the certificate or certification request in Privacy Enhanced Mail (PEM) format. PEM uses 64 ASCII characters to convert the binary certificate into a printable form. You can copy and paste the certificate into an e-mail to send to friends or colleagues or you can copy and paste the certificate into a text editor and save the file on a management computer for later distribution (via floppy disk for example).
Apply	Click Apply to save your changes back to the ZyWALL. You can only change the name and/or set whether or not you want the ZyWALL to check the CRL that the certification authority issues before trusting a certificate issued by the certification authority.
Cancel	Click Cancel to quit and return to the Trusted CAs screen.

15.12 Trusted CA Import

Click **SECURITY > CERTIFICATES > Trusted CAs** to open the **Trusted CAs** screen and then click **Import** to open the **Trusted CA Import** screen. Follow the instructions in this screen to save a trusted certification authority's certificate from a computer to the ZyWALL. The ZyWALL trusts any valid certificate signed by any of the imported trusted CA certificates.



You must remove any spaces from the certificate's filename before you can import the certificate.

Figure 191 SECURITY > CERTIFICATES > Trusted CAs > Import

The following table describes the labels in this screen.

Table 82 SECURITY > CERTIFICATES > Trusted CAs Import

LABEL	DESCRIPTION
File Path	Type in the location of the file you want to upload in this field or click Browse to find it.
Browse	Click Browse to find the certificate file you want to upload.

Table 82 SECURITY > CERTIFICATES > Trusted CAs Import

LABEL	DESCRIPTION
Apply	Click Apply to save the certificate on the ZyWALL.
Cancel	Click Cancel to quit and return to the Trusted CAs screen.

15.13 Trusted Remote Hosts

Click **SECURITY > CERTIFICATES > Trusted Remote Hosts** to open the **Trusted Remote Hosts** screen. This screen displays a list of the certificates of peers that you trust but which are not signed by one of the certification authorities on the **Trusted CAs** screen.

You do not need to add any certificate that is signed by one of the certification authorities on the **Trusted CAs** screen since the ZyWALL automatically accepts any valid certificate signed by a trusted certification authority as being trustworthy.

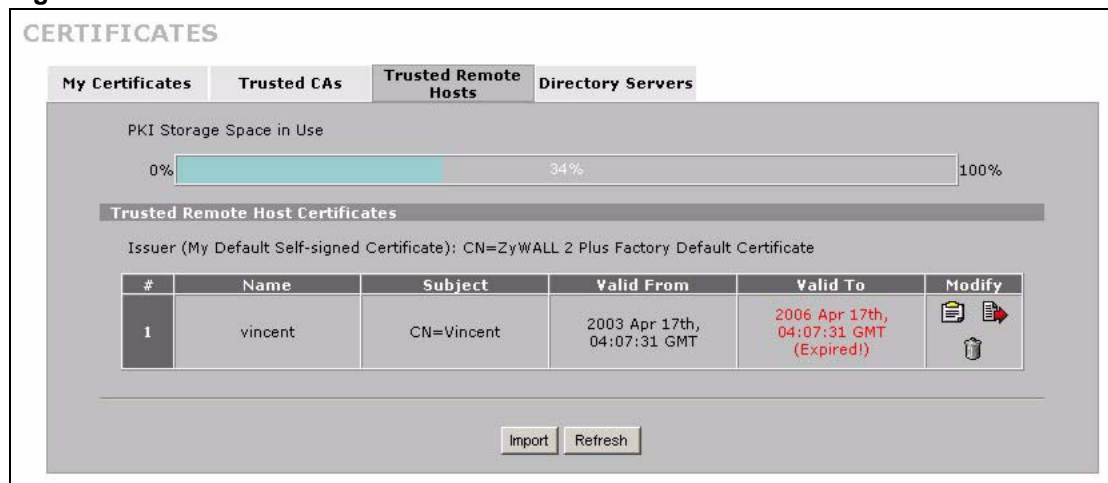
Figure 192 SECURITY > CERTIFICATES > Trusted Remote Hosts

The following table describes the labels in this screen.

Table 83 SECURITY > CERTIFICATES > Trusted Remote Hosts

LABEL	DESCRIPTION
PKI Storage Space in Use	This bar displays the percentage of the ZyWALL's PKI storage space that is currently in use. When the storage space is almost full, you should consider deleting expired or unnecessary certificates before adding more certificates.
Issuer (My Default Self-signed Certificate)	This field displays identifying information about the default self-signed certificate on the ZyWALL that the ZyWALL uses to sign the trusted remote host certificates.
#	This field displays the certificate index number. The certificates are listed in alphabetical order.
Name	This field displays the name used to identify this certificate.
Subject	This field displays identifying information about the certificate's owner, such as CN (Common Name), OU (Organizational Unit or department), O (Organization or company) and C (Country). It is recommended that each certificate have unique subject information.
Valid From	This field displays the date that the certificate becomes applicable. The text displays in red and includes a Not Yet Valid! message if the certificate has not yet become applicable.

Table 83 SECURITY > CERTIFICATES > Trusted Remote Hosts (continued)

LABEL	DESCRIPTION
Valid To	This field displays the date that the certificate expires. The text displays in red and includes an Expiring! or Expired! message if the certificate is about to expire or has already expired.
Modify	Click the details icon to open a screen with an in-depth list of information about the certificate. Use the export icon to save the certificate to a computer. Click the icon and then Save in the File Download screen. The Save As screen opens, browse to the location that you want to use and click Save . Click the delete icon to remove the certificate. A window displays asking you to confirm that you want to delete the certificate. Note that subsequent certificates move up by one when you take this action.
Import	Click Import to open a screen where you can save the certificate of a remote host (which you trust) from your computer to the ZyWALL.
Refresh	Click this button to display the current validity status of the certificates.

15.14 Trusted Remote Host Certificate Details

Click **SECURITY > CERTIFICATES > Trusted Remote Hosts** to open the **Trusted Remote Hosts** screen. Click the details icon to open the **Trusted Remote Host Details** screen. You can use this screen to view in-depth information about the trusted remote host's certificate and/or change the certificate's name.

Figure 193 SECURITY > CERTIFICATES > Trusted Remote Hosts > Details

CERTIFICATES - TRUSTED REMOTE HOST - DETAILS

Name

Certification Path

Certificate Information

Type	CA-signed X.509 Certificate
Version	V3
Serial Number	105063885153
Subject	CN=Vincent
Issuer	CN=ZyWALL 2 Plus 001349000001
Signature Algorithm	rsa-pkcs1-sha1
Valid From	2003 Apr 17th, 04:07:31 GMT
Valid To	2006 Apr 17th, 04:07:31 GMT (Expired!)
Key Algorithm	rsaEncryption (1024 bits)
Subject Alternative Name	DNS=Vincent
Key Usage	DigitalSignature
Basic Constraint	Path Length Constraint=10
MDS Fingerprint	7e:24:17:2e:6a:a3:5c:73:c0:78:d8:0c:bc:9c:40:a5
SHA1 Fingerprint	48:4c:91:32:e1:ea:7d:c8:c5:19:d4:97:ee:85:3c:40:c4:6a:7b:7f

Certificate in PEM (Base-64) Encoded Format

```

MIIEpzCCA VGgAwIBAgIFGHZLqWEwDQYJKoZIhvcNAQEFBQAwJTEjMCEGA1UEAxMa
Wn1XQUxMID IgUGx1cyAwMDEzNDkwMDAwMDEwHhcNMDMwNDUzMDQwNzIxMDEw
NDEzMDQwNzIxMDEwMDEwMDEwMDEwMDEwMDEwMDEwMDEwMDEwMDEwMDEwMDEw
A4GNADCBiQKBggQCDjts73SPybRFVubOieofPPtG6aqujwk1k/N1qgryp8vomLBK
arROa8DS5p7TV5Y2PrakOKskKwQNrWz9S5z56kqLITb8YIzqeoytvc67GM/3AQgC
OLbutR5qH11Ka7EsQCxvOkNvAcHI2oFABneOMMFctejtIghUtKUIoAGnTwIDAQAB
ozcwNTALBgNVHQ8EBAMCAoQwEgYDVROBAswCYIHVmluY2VudAsBgNVHRMBAQAE
CDAGAQEAAgEKMAOGCSqGS Ib3DQEBBQUAAOE A jhzSkrfs0Juh6nmG5jRoKNUuPw2Q
xR9sLseXGBzLIQbJZVY2LrgOHK3Vqt1c1X4QLI1fFj76cIQVXG18Xo/1Ug==
-----END CERTIFICATE-----

```

The following table describes the labels in this screen.

Table 84 SECURITY > CERTIFICATES > Trusted Remote Hosts > Details

LABEL	DESCRIPTION
Name	This field displays the identifying name of this certificate. If you want to change the name, type up to 31 characters to identify this key certificate. You may use any character (not including spaces).
Certification Path	Click the Refresh button to have this read-only text box display the end entity's own certificate and a list of certification authority certificates in the hierarchy of certification authorities that validate a certificate's issuing certification authority. For a trusted host, the list consists of the end entity's own certificate and the default self-signed certificate that the ZyWALL uses to sign remote host certificates.
Refresh	Click Refresh to display the certification path.
Certificate Information	These read-only fields display detailed information about the certificate.
Type	This field displays general information about the certificate. With trusted remote host certificates, this field always displays CA-signed. The ZyWALL is the Certification Authority that signed the certificate. X.509 means that this certificate was created and signed according to the ITU-T X.509 recommendation that defines the formats for public-key certificates.

Table 84 SECURITY > CERTIFICATES > Trusted Remote Hosts > Details (continued)

LABEL	DESCRIPTION
Version	This field displays the X.509 version number.
Serial Number	This field displays the certificate's identification number given by the device that created the certificate.
Subject	This field displays information that identifies the owner of the certificate, such as Common Name (CN), Organizational Unit (OU), Organization (O) and Country (C).
Issuer	This field displays identifying information about the default self-signed certificate on the ZyWALL that the ZyWALL uses to sign the trusted remote host certificates.
Signature Algorithm	This field displays the type of algorithm that the ZyWALL used to sign the certificate, which is rsa-pkcs1-sha1 (RSA public-private key encryption algorithm and the SHA1 hash algorithm).
Valid From	This field displays the date that the certificate becomes applicable. The text displays in red and includes a Not Yet Valid! message if the certificate has not yet become applicable.
Valid To	This field displays the date that the certificate expires. The text displays in red and includes an Expiring! or Expired! message if the certificate is about to expire or has already expired.
Key Algorithm	This field displays the type of algorithm that was used to generate the certificate's key pair (the ZyWALL uses RSA encryption) and the length of the key set in bits (1024 bits for example).
Subject Alternative Name	This field displays the certificate's owner's IP address (IP), domain name (DNS) or e-mail address (EMAIL).
Key Usage	This field displays for what functions the certificate's key can be used. For example, "DigitalSignature" means that the key can be used to sign certificates and "KeyEncipherment" means that the key can be used to encrypt text.
Basic Constraint	This field displays general information about the certificate. For example, Subject Type=CA means that this is a certification authority's certificate and "Path Length Constraint=1" means that there can only be one certification authority in the certificate's path.
MD5 Fingerprint	This is the certificate's message digest that the ZyWALL calculated using the MD5 algorithm. The ZyWALL uses one of its own self-signed certificates to sign the imported trusted remote host certificates. This changes the fingerprint value displayed here (so it does not match the original). See Section 15.3 on page 274 for how to verify a remote host's certificate before you import it into the ZyWALL.
SHA1 Fingerprint	This is the certificate's message digest that the ZyWALL calculated using the SHA1 algorithm. The ZyWALL uses one of its own self-signed certificates to sign the imported trusted remote host certificates. This changes the fingerprint value displayed here (so it does not match the original). See Section 15.3 on page 274 for how to verify a remote host's certificate before you import it into the ZyWALL.
Certificate in PEM (Base-64) Encoded Format	This read-only text box displays the certificate or certification request in Privacy Enhanced Mail (PEM) format. PEM uses 64 ASCII characters to convert the binary certificate into a printable form. You can copy and paste the certificate into an e-mail to send to friends or colleagues or you can copy and paste the certificate into a text editor and save the file on a management computer for later distribution (via floppy disk for example).

Table 84 SECURITY > CERTIFICATES > Trusted Remote Hosts > Details (continued)

LABEL	DESCRIPTION
Apply	Click Apply to save your changes back to the ZyWALL. You can only change the name of the certificate.
Cancel	Click Cancel to quit configuring this screen and return to the Trusted Remote Hosts screen.

15.15 Trusted Remote Hosts Import

Click **SECURITY > CERTIFICATES > Trusted Remote Hosts** to open the **Trusted Remote Hosts** screen and then click **Import** to open the **Trusted Remote Host Import** screen.

You may have peers with certificates that you want to trust, but the certificates were not signed by one of the certification authorities on the **Trusted CAs** screen. Follow the instructions in this screen to save a peer's certificates from a computer to the ZyWALL.

You do not need to add any certificate that is signed by one of the certification authorities on the **Trusted CAs** screen since the ZyWALL automatically accepts any valid certificate signed by a trusted certification authority as being trustworthy.



The trusted remote host certificate must be a self-signed certificate; and you must remove any spaces from its filename before you can import it.

Figure 194 SECURITY > CERTIFICATES > Trusted Remote Hosts > Import

The following table describes the labels in this screen.

Table 85 SECURITY > CERTIFICATES > Trusted Remote Hosts > Import

LABEL	DESCRIPTION
File Path	Type in the location of the file you want to upload in this field or click Browse to find it.
Browse	Click Browse to find the certificate file you want to upload.

Table 85 SECURITY > CERTIFICATES > Trusted Remote Hosts > Import

LABEL	DESCRIPTION
Apply	Click Apply to save the certificate on the ZyWALL.
Cancel	Click Cancel to quit and return to the Trusted Remote Hosts screen.

15.16 Directory Servers

Click **SECURITY > CERTIFICATES > Directory Servers** to open the **Directory Servers** screen. This screen displays a summary list of directory servers (that contain lists of valid and revoked certificates) that have been saved into the ZyWALL. If you decide to have the ZyWALL check incoming certificates against the issuing certification authority's list of revoked certificates, the ZyWALL first checks the server(s) listed in the **CRL Distribution Points** field of the incoming certificate. If the certificate does not list a server or the listed server is not available, the ZyWALL checks the servers listed here.

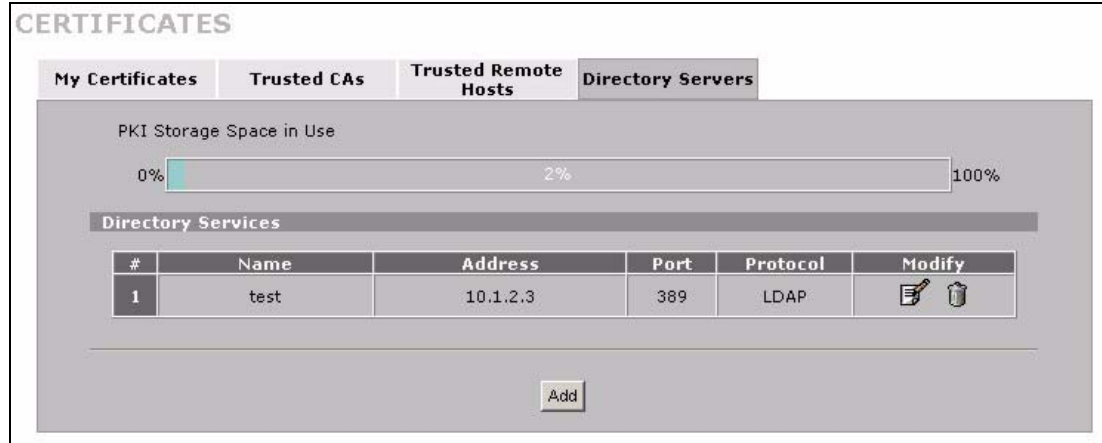
Figure 195 SECURITY > CERTIFICATES > Directory Servers

The following table describes the labels in this screen.

Table 86 SECURITY > CERTIFICATES > Directory Servers

LABEL	DESCRIPTION
PKI Storage Space in Use	This bar displays the percentage of the ZyWALL's PKI storage space that is currently in use. When the storage space is almost full, you should consider deleting expired or unnecessary certificates before adding more certificates.
#	The index number of the directory server. The servers are listed in alphabetical order.
Name	This field displays the name used to identify this directory server.
Address	This field displays the IP address or domain name of the directory server.
Port	This field displays the port number that the directory server uses.
Protocol	This field displays the protocol that the directory server uses.

Table 86 SECURITY > CERTIFICATES > Directory Servers

LABEL	DESCRIPTION
Modify	Click the details icon to open a screen where you can change the information about the directory server. Click the delete icon to remove the directory server entry. A window displays asking you to confirm that you want to delete the directory server. Note that subsequent certificates move up by one when you take this action.
Add	Click Add to open a screen where you can configure information about a directory server so that the ZyWALL can access it.

15.17 Directory Server Add or Edit

Click **SECURITY > CERTIFICATES > Directory Servers** to open the **Directory Servers** screen. Click **Add** (or the details icon) to open the **Directory Server Add** screen. Use this screen to configure information about a directory server that the ZyWALL can access.

Figure 196 SECURITY > CERTIFICATES > Directory Server > Add

The following table describes the labels in this screen.

Table 87 SECURITY > CERTIFICATES > Directory Server > Add

LABEL	DESCRIPTION
Directory Service Setting	
Name	Type up to 31 ASCII characters (spaces are not permitted) to identify this directory server.
Access Protocol	Use the drop-down list box to select the access protocol used by the directory server. LDAP (Lightweight Directory Access Protocol) is a protocol over TCP that specifies how clients access directories of certificates and lists of revoked certificates. ^A
Server Address	Type the IP address (in dotted decimal notation) or the domain name of the directory server.
Server Port	This field displays the default server port number of the protocol that you select in the Access Protocol field. You may change the server port number if needed, however you must use the same server port number that the directory server uses. 389 is the default server port number for LDAP.

Table 87 SECURITY > CERTIFICATES > Directory Server > Add

LABEL	DESCRIPTION
Login Setting	
Login	The ZyWALL may need to authenticate itself in order to assess the directory server. Type the login name (up to 31 ASCII characters) from the entity maintaining the directory server (usually a certification authority).
Password	Type the password (up to 31 ASCII characters) from the entity maintaining the directory server (usually a certification authority).
Apply	Click Apply to save your changes back to the ZyWALL.
Cancel	Click Cancel to quit configuring this screen and return to the Directory Servers screen.

A. At the time of writing, LDAP is the only choice of directory server access protocol.

Authentication Server

This chapter discusses how to configure the ZyWALL's authentication server feature.

16.1 Authentication Server Overview

A ZyWALL set to be a VPN extended authentication server can use either the local user database internal to the ZyWALL or an external RADIUS (Remote Authentication Dial In User Service, RFC 2138, 2139) server for an unlimited number of users. The ZyWALL uses the same local user database for VPN extended authentication.

16.1.1 Local User Database

By storing user profiles locally on the ZyWALL, your ZyWALL is able to authenticate users without interacting with a network RADIUS server. However, there is a limit on the number of users you may authenticate in this way.

16.1.2 RADIUS

The ZyWALL can use a RADIUS server to authenticate an unlimited number of users. RADIUS is based on a client-server model that supports authentication, authorization and accounting. The access point is the client and the server is the RADIUS server. The RADIUS server handles the following tasks:

- Authentication
Determines the identity of the users.
- Authorization
Determines the network services available to authenticated users once they are connected to the network.
- Accounting
Keeps track of the client's network activity.

RADIUS is a simple package exchange in which the ZyWALL acts as a message relay between the client and the network RADIUS server.

16.1.3 Types of RADIUS Messages

The following types of RADIUS messages are exchanged between the ZyWALL and the RADIUS server for user authentication:

- Access-Request

- Sent by an access point requesting authentication.
- Access-Reject
Sent by a RADIUS server rejecting access.
- Access-Accept
Sent by a RADIUS server allowing access.
- Access-Challenge
Sent by a RADIUS server requesting more information in order to allow access. The access point sends a proper response from the user and then sends another Access-Request message.

The following types of RADIUS messages are exchanged between the ZyWALL and the RADIUS server for user accounting:

- Accounting-Request
Sent by the access point requesting accounting.
- Accounting-Response
Sent by the RADIUS server to indicate that it has started or stopped accounting.

In order to ensure network security, the ZyWALL and the RADIUS server use a shared secret key, which is a password, they both know. The key is not sent over the network. In addition to the shared key, password information exchanged is also encrypted to protect the network from unauthorized access.

16.2 Local User Database

Click **SECURITY > AUTH SERVER** to open the **Local User Database** screen. The local user database is a list of user profiles stored on the ZyWALL. The ZyWALL can use this list of user profiles to authenticate users. Use this screen to change your ZyWALL's list of user profiles.

Figure 197 SECURITY > AUTH SERVER > Local User Database

AUTHENTICATION SERVER

Local User Database RADIUS

User Database

#	Active	User Name	Password
1	<input type="checkbox"/>		
2	<input type="checkbox"/>		
3	<input type="checkbox"/>		
4	<input type="checkbox"/>		
5	<input type="checkbox"/>		
6	<input type="checkbox"/>		
7	<input type="checkbox"/>		
8	<input type="checkbox"/>		
9	<input type="checkbox"/>		
10	<input type="checkbox"/>		
11	<input type="checkbox"/>		
12	<input type="checkbox"/>		
13	<input type="checkbox"/>		
14	<input type="checkbox"/>		
15	<input type="checkbox"/>		
16	<input type="checkbox"/>		
17	<input type="checkbox"/>		
18	<input type="checkbox"/>		
19	<input type="checkbox"/>		
20	<input type="checkbox"/>		
21	<input type="checkbox"/>		
22	<input type="checkbox"/>		
23	<input type="checkbox"/>		
24	<input type="checkbox"/>		
25	<input type="checkbox"/>		
26	<input type="checkbox"/>		
27	<input type="checkbox"/>		
28	<input type="checkbox"/>		
29	<input type="checkbox"/>		
30	<input type="checkbox"/>		
31	<input type="checkbox"/>		
32	<input type="checkbox"/>		

Apply Reset

The following table describes the labels in this screen.

Table 88 SECURITY > AUTH SERVER > Local User Database

LABEL	DESCRIPTION
Active	Select this check box to enable the user profile.
User Name	Enter the user name of the user profile.
Password	Enter a password up to 31 characters long for this user profile.
Apply	Click Apply to save your changes back to the ZyWALL.
Reset	Click Reset to begin configuring this screen afresh.

16.3 RADIUS

Click **SECURITY > AUTH SERVER > RADIUS** to open the **RADIUS** screen. Configure this screen to use an external RADIUS server to authenticate users.

Figure 198 SECURITY > AUTH SERVER > RADIUS

The following table describes the labels in this screen.

Table 89 SECURITY > AUTH SERVER > RADIUS

LABEL	DESCRIPTION
Authentication Server	
Active	Select the check box to enable user authentication through an external authentication server. Clear the check box to enable user authentication using the local user profile on the ZyWALL.
Server IP Address	Enter the IP address of the external authentication server in dotted decimal notation.
Port Number	The default port of the RADIUS server for authentication is 1812 . You need not change this value unless your network administrator instructs you to do so with additional information.
Key	Enter a password (up to 31 alphanumeric characters) as the key to be shared between the external authentication server and the ZyWALL. The key is not sent over the network. This key must be the same on the external authentication server and ZyWALL.
Accounting Server	
Active	Select the check box to enable user accounting through an external authentication server.
Server IP Address	Enter the IP address of the external accounting server in dotted decimal notation.
Port Number	The default port of the RADIUS server for accounting is 1813 . You need not change this value unless your network administrator instructs you to do so with additional information.

Table 89 SECURITY > AUTH SERVER > RADIUS

LABEL	DESCRIPTION
Key	Enter a password (up to 31 alphanumeric characters) as the key to be shared between the external accounting server and the ZyWALL. The key is not sent over the network. This key must be the same on the external accounting server and ZyWALL.
Apply	Click Apply to save your changes back to the ZyWALL.
Reset	Click Reset to begin configuring this screen afresh.

PART IV

Advanced

Network Address Translation (NAT) (307)

Static Route (321)

Bandwidth Management (325)

DNS (339)

Remote Management (351)

UPnP (373)

ALG Screen (383)

Network Address Translation (NAT)

This chapter discusses how to configure NAT on the ZyWALL.

17.1 NAT Overview

NAT (Network Address Translation - NAT, RFC 1631) is the translation of the IP address of a host in a packet. For example, the source address of an outgoing packet, used within one network is changed to a different IP address known within another network.

17.1.1 NAT Definitions

Inside/outside denotes where a host is located relative to the ZyWALL. For example, the computers of your subscribers are the inside hosts, while the web servers on the Internet are the outside hosts.

Global/local denotes the IP address of a host in a packet as the packet traverses a router. For example, the local address refers to the IP address of a host when the packet is in the local network, while the global address refers to the IP address of the host when the same packet is traveling in the WAN side.

Note that inside/outside refers to the location of a host, while global/local refers to the IP address of a host used in a packet. Thus, an inside local address (ILA) is the IP address of an inside host in a packet when the packet is still in the local network, while an inside global address (IGA) is the IP address of the same inside host when the packet is on the WAN side. The following table summarizes this information.

Table 90 NAT Definitions

TERM	DESCRIPTION
Inside	This refers to the host on the LAN.
Outside	This refers to the host on the WAN.
Local	This refers to the packet address (source or destination) as the packet travels on the LAN.
Global	This refers to the packet address (source or destination) as the packet travels on the WAN.



NAT never changes the IP address (either local or global) of an outside host.

17.1.2 What NAT Does

In the simplest form, NAT changes the source IP address in a packet received from a subscriber (the inside local address) to another (the inside global address) before forwarding the packet to the WAN side. When the response comes back, NAT translates the destination address (the inside global address) back to the inside local address before forwarding it to the original inside host. Note that the IP address (either local or global) of an outside host is never changed.

The global IP addresses for the inside hosts can be either static or dynamically assigned by the ISP. In addition, you can designate servers (for example a web server and a telnet server) on your local network and make them accessible to the outside world. Although you can make designated servers on the LAN accessible to the outside world, it is strongly recommended that you attach those servers to the DMZ port instead. If you do not define any servers (for Many-to-One and Many-to-Many Overload mapping), NAT offers the additional benefit of firewall protection. With no servers defined, your ZyWALL filters out all incoming inquiries, thus preventing intruders from probing your network. For more information on IP address translation, refer to RFC 1631, The IP Network Address Translator (NAT).

17.1.3 How NAT Works

Each packet has two addresses – a source address and a destination address. For outgoing packets, the ILA (Inside Local Address) is the source address on the LAN, and the IGA (Inside Global Address) is the source address on the WAN. For incoming packets, the ILA is the destination address on the LAN, and the IGA is the destination address on the WAN. NAT maps private (local) IP addresses to globally unique ones required for communication with hosts on other networks. It replaces the original IP source address (and TCP or UDP source port numbers for Many-to-One and Many-to-Many Overload NAT mapping) in each packet and then forwards it to the Internet. The ZyWALL keeps track of the original addresses and port numbers so incoming reply packets can have their original values restored. The following figure illustrates this.

Figure 199 How NAT Works

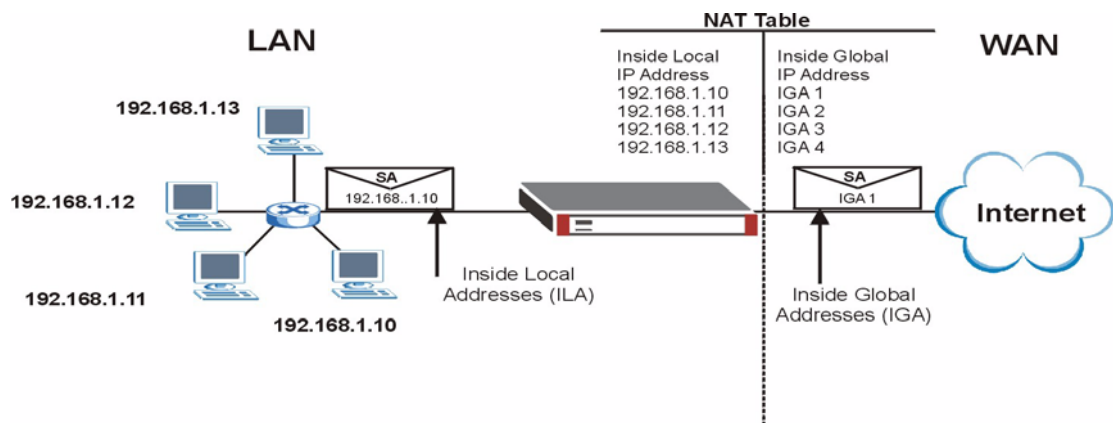

17.1.4 NAT Application

The following figure illustrates a possible NAT application, where three inside LANs (logical LANs using IP alias) behind the ZyWALL can communicate with three distinct WAN networks. More examples follow at the end of this chapter.

Figure 200 NAT Application With IP Alias

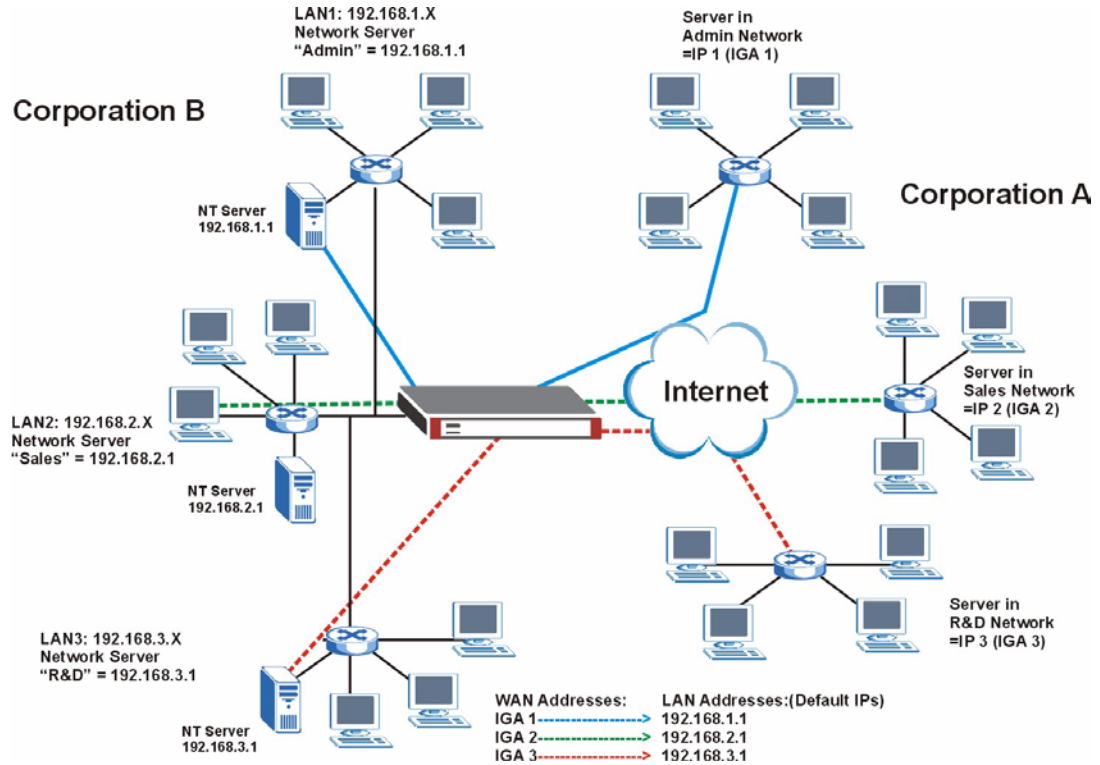

17.1.5 Port Restricted Cone NAT

ZyWALL ZyNOS version 4.00 and later uses port restricted cone NAT. Port restricted cone NAT maps all outgoing packets from an internal IP address and port to a single IP address and port on the external network. In the following example, the ZyWALL maps the source address of all packets sent from internal IP address **1** and port **A** to IP address **2** and port **B** on the external network. A host on the external network (IP address **3** and Port **C** for example) can only send packets to the internal host if the internal host has already sent a packet to the external host's IP address and port.

A server with IP address **1** and port **A** sends packets to IP address **3**, port **C** and IP address **4**, port **D**. The ZyWALL changes the server's IP address to **2** and port to **B**.

Since **1, A** has already sent packets to **3, C** and **4, D**, they can send packets back to **2, B** and the ZyWALL will perform NAT on them and send them to the server at IP address **1**, port **A**.

Packets have not been sent from **1, A** to **4, E** or **5**, so they cannot send packets to **1, A**.

Figure 201 Port Restricted Cone NAT Example

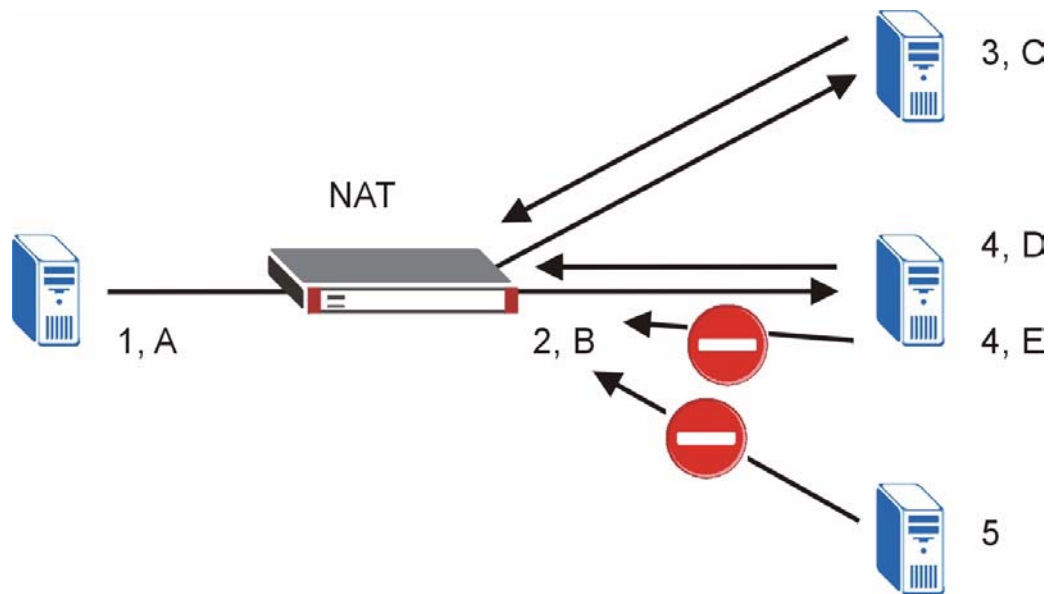

17.1.6 NAT Mapping Types

NAT supports five types of IP/port mapping. They are:

- **One to One:** In One-to-One mode, the ZyWALL maps one local IP address to one global IP address.
- **Many to One:** In Many-to-One mode, the ZyWALL maps multiple local IP addresses to one global IP address. This is equivalent to SUA (i.e., PAT, port address translation), ZyXEL's Single User Account feature (the **SUA** option).
- **Many to Many Overload:** In Many-to-Many Overload mode, the ZyWALL maps the multiple local IP addresses to shared global IP addresses.
- **Many One to One:** In Many-One-to-One mode, the ZyWALL maps each local IP address to a unique global IP address.
- **Server:** This type allows you to specify inside servers of different services behind the NAT to be accessible to the outside world although, it is highly recommended that you use the DMZ port for these servers instead.



Port numbers do not change for One-to-One and Many-One-to-One NAT mapping types.

The following table summarizes the NAT mapping types.

Table 91 NAT Mapping Types

TYPE	IP MAPPING	SMT ABBREVIATION
One-to-One	ILA1 ↔ IGA1	1-1
Many-to-One (SUA/PAT)	ILA1 ↔ IGA1 ILA2 ↔ IGA1 ...	M-1
Many-to-Many Overload	ILA ↔ IGA1 ILA2 ↔ IGA2 ILA3 ↔ IGA1 ILA4 ↔ IGA2 ...	M-M Ov
Many-One-to-One	ILA1 ↔ IGA1 ILA2 ↔ IGA2 ILA3 ↔ IGA3 ...	M-1-1
Server	Server 1 IP ↔ IGA1 Server 2 IP ↔ IGA1 Server 3 IP ↔ IGA1	Server

17.2 Using NAT



You must create a firewall rule in addition to setting up SUA/NAT, to allow traffic from the WAN to be forwarded through the ZyWALL.

17.2.1 SUA (Single User Account) Versus NAT

SUA (Single User Account) is a ZYNOS implementation of a subset of NAT that supports two types of mapping, **Many-to-One** and **Server**. The ZyWALL also supports **Full Feature** NAT to map multiple global IP addresses to multiple private LAN IP addresses of clients or servers using mapping types. Select either **SUA** or **Full Feature** in **NAT Overview**.

Selecting **SUA** means (latent) multiple WAN-to-LAN and WAN-to-DMZ address translation. That means that computers on your DMZ with public IP addresses will still have to undergo NAT mapping if you're using **SUA** NAT mapping. If this is not your intention, then select **Full Feature** NAT and don't configure NAT mapping rules to those computers with public IP addresses on the DMZ.

17.3 NAT Overview Screen

Click **ADVANCED > NAT** to open the **NAT Overview** screen.

Figure 202 ADVANCED > NAT > NAT Overview

The following table describes the labels in this screen.

Table 92 ADVANCED > NAT > NAT Overview

LABEL	DESCRIPTION
NAT Setup	
Max. Concurrent Sessions	This read-only field displays the highest number of NAT sessions that the ZyWALL will permit at one time.
Max. Concurrent Sessions Per Host	Use this field to set the highest number of NAT sessions that the ZyWALL will permit a host to have at one time.
Enable NAT	Select this check box to turn on the NAT feature for the WAN port. Clear this check box to turn off the NAT feature for the WAN port.
Address Mapping Rules	Select SUA if you have just one public WAN IP address for your ZyWALL. This lets the ZyWALL use its permanent, pre-defined NAT address mapping rules. Select Full Feature if you have multiple public WAN IP addresses for your ZyWALL. This lets the ZyWALL use the address mapping rules that you configure. This is the equivalent of what used to be called full feature NAT or multi-NAT. The bar displays how many of the ZyWALL's possible address mapping rules are configured. The first number shows how many address mapping rules are configured on the ZyWALL. The second number shows the maximum number of address mapping rules that can be configured on the ZyWALL.
Port Forwarding Rules	The bar displays how many of the ZyWALL's possible port forwarding rules are configured. The first number shows how many port forwarding rules are configured on the ZyWALL. The second number shows the maximum number of port forwarding rules that can be configured on the ZyWALL.
Port Triggering Rules	The bar displays how many of the ZyWALL's possible trigger port rules are configured. The first number shows how many trigger port rules are configured on the ZyWALL. The second number shows the maximum number of trigger port rules that can be configured on the ZyWALL.
Apply	Click Apply to save your changes back to the ZyWALL.
Reset	Click Reset to begin configuring this screen afresh.

17.4 NAT Address Mapping

Click **ADVANCED > NAT > Address Mapping** to open the following screen.

Use this screen to change your ZyWALL's address mapping settings. Not all fields are available on all models.

Ordering your rules is important because the ZyWALL applies the rules in the order that you specify. When a rule matches the current packet, the ZyWALL takes the corresponding action and the remaining rules are ignored. If there are any empty rules before your new configured rule, your configured rule will be pushed up by that number of empty rules. For example, if you have already configured rules 1 to 6 in your current set and now you configure rule number 9. In the set summary screen, the new rule will be rule 7, not 9. Now if you delete rule 4, rules 5 to 7 will be pushed up by 1 rule, so old rules 5, 6 and 7 become new rules 4, 5 and 6.

Figure 203 ADVANCED > NAT > Address Mapping

NAT

NAT Overview **Address Mapping** **Port Forwarding** **Port Triggering**

SUA Address Mapping Rules

#	Local Start IP	Local End IP	Global Start IP	Global End IP	Type
1	0.0.0.0	255.255.255.255	0.0.0.0	N/A	M-1
2	N/A	N/A	0.0.0.0	N/A	Server

Full Feature Address Mapping Rules

#	Local Start IP	Local End IP	Global Start IP	Global End IP	Type	Modify
1	192.168.1.12	N/A	1.2.3.5	N/A	1-1	
2	192.168.1.13	N/A	1.2.3.6	N/A	1-1	
3	192.168.1.1	192.168.1.254	1.2.3.4	N/A	M-1	
4	-	
5	-	
6	-	
7	-	
8	-	
9	-	
10	-	

new rule before rule (rule number)

The following table describes the labels in this screen.

Table 93 ADVANCED > NAT > Address Mapping

LABEL	DESCRIPTION
SUA Address Mapping Rules	This read-only table displays the default address mapping rules.
Full Feature Address Mapping Rules	

Table 93 ADVANCED > NAT > Address Mapping (continued)

LABEL	DESCRIPTION
#	This is the rule index number.
Local Start IP	This refers to the Inside Local Address (ILA), which is the starting local IP address. If the rule is for all local IP addresses, then this field displays 0.0.0.0 as the Local Start IP address. Local IP addresses are N/A for Server port mapping.
Local End IP	This is the end Inside Local Address (ILA). If the rule is for all local IP addresses, then this field displays 255.255.255.255 as the Local End IP address. This field is N/A for One-to-One and Server mapping types.
Global Start IP	This refers to the Inside Global IP Address (IGA), that is the starting global IP address. 0.0.0.0 is for a dynamic IP address from your ISP with Many-to-One and Server mapping types.
Global End IP	This is the ending Inside Global Address (IGA). This field is N/A for One-to-One , Many-to-One and Server mapping types.
Type	<ol style="list-style-type: none"> One-to-One mode maps one local IP address to one global IP address. Note that port numbers do not change for the One-to-One NAT mapping type. Many-to-One mode maps multiple local IP addresses to one global IP address. This is equivalent to SUA (i.e., PAT, port address translation), ZyXEL's Single User Account feature that previous ZyXEL routers supported only. Many-to-Many Overload mode maps multiple local IP addresses to shared global IP addresses. Many One-to-One mode maps each local IP address to unique global IP addresses. Server allows you to specify inside servers of different services behind the NAT to be accessible to the outside world.
Modify	Click the edit icon to go to the screen where you can edit the address mapping rule. Click the delete icon to delete an existing address mapping rule. A window display asking you to confirm that you want to delete the address mapping rule. Note that subsequent address mapping rules move up by one when you take this action.
Insert	Click Insert to insert a new mapping rule before an existing one.

17.4.1 NAT Address Mapping Edit

Click the **Edit** button to display the **NAT Address Mapping Edit** screen. Use this screen to edit an address mapping rule.

Figure 204 ADVANCED > NAT > Address Mapping > Edit

NAT - ADDRESS MAPPING

Address Mapping Rule

Type: One-to-One

Local Start IP: 0 . 0 . 0 . 0

Local End IP: N/A

Global Start IP: 0 . 0 . 0 . 0

Global End IP: N/A

Apply Cancel

The following table describes the labels in this screen.

Table 94 ADVANCED > NAT > Address Mapping > Edit

LABEL	DESCRIPTION
Type	Choose the port mapping type from one of the following. 1. One-to-One : One-to-One mode maps one local IP address to one global IP address. Note that port numbers do not change for One-to-One NAT mapping type. 2. Many-to-One : Many-to-One mode maps multiple local IP addresses to one global IP address. This is equivalent to SUA (i.e., PAT, port address translation), ZyXEL's Single User Account feature. 3. Many-to-Many Overload : Many-to-Many Overload mode maps multiple local IP addresses to shared global IP addresses. 4. Many One-to-One : Many One-to-One mode maps each local IP address to unique global IP addresses. 5. Server : This type allows you to specify inside servers of different services behind the NAT to be accessible to the outside world.
Local Start IP	This is the starting Inside Local IP Address (ILA). Local IP addresses are N/A for Server port mapping.
Local End IP	This is the end Inside Local IP Address (ILA). If your rule is for all local IP addresses, then enter 0.0.0.0 as the Local Start IP address and 255.255.255.255 as the Local End IP address. This field is N/A for One-to-One and Server mapping types.
Global Start IP	This is the starting Inside Global IP Address (IGA). Enter 0.0.0.0 here if you have a dynamic IP address from your ISP.
Global End IP	This is the ending Inside Global IP Address (IGA). This field is N/A for One-to-One , Many-to-One and Server mapping types.
Apply	Click Apply to save your changes back to the ZyWALL.
Cancel	Click Cancel to exit this screen without saving.

17.5 Port Forwarding

A port forwarding set is a list of inside (behind NAT on the LAN) servers, for example, web or FTP, that you can make visible to the outside world even though NAT makes your whole inside network appear as a single computer to the outside world.

You may enter a single port number or a range of port numbers to be forwarded, and the local IP address of the desired server. The port number identifies a service; for example, web service is on port 80 and FTP on port 21. In some cases, such as for unknown services or where one server can support more than one service (for example both FTP and web service), it might be better to specify a range of port numbers. You can allocate a server IP address that corresponds to a port or a range of ports.

Many residential broadband ISP accounts do not allow you to run any server processes (such as a Web or FTP server) from your location. Your ISP may periodically check for servers and may suspend your account if it discovers any active services at your location. If you are unsure, refer to your ISP.

17.5.1 Default Server IP Address

In addition to the servers for specified services, NAT supports a default server IP address. A default server receives packets from ports that are not specified in this screen.



If you do not assign a Default Server IP address, the ZyWALL discards all packets received for ports that are not specified here or in the remote management setup.

17.5.2 Port Forwarding: Services and Port Numbers

Use the **Port Forwarding** screen to forward incoming service requests to the server(s) on your local network. See [Appendix E on page 615](#) for a list of commonly used services and port numbers.

The ZyWALL provides the additional safety of the DMZ ports for connecting your publicly accessible servers. This makes the LAN more secure by physically separating it from your public servers.

17.5.3 Configuring Servers Behind Port Forwarding (Example)

Let's say you want to assign ports 21-25 to one FTP, Telnet and SMTP server (**A** in the example), port 80 to another (**B** in the example) and assign a default server IP address of 192.168.1.35 to a third (**C** in the example). You assign the LAN IP addresses and the ISP assigns the WAN IP address. The NAT network appears as a single host on the Internet.

Figure 205 Multiple Servers Behind NAT Example

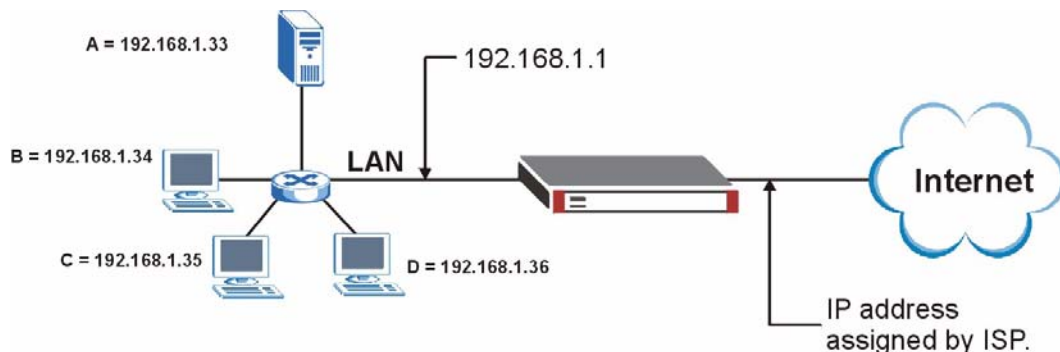

17.5.4 Port Translation

The ZyWALL can translate the destination port number or a range of port numbers of packets coming from the WAN to another destination port number or range of port numbers on the local network. When you use port forwarding without port translation, a single server on the local network can use a specific port number and be accessible to the outside world through a single WAN IP address. When you use port translation with port forwarding, multiple servers on the local network can use the same port number and still be accessible to the outside world through a single WAN IP address.

The following example has two web servers on a LAN. Server **A** uses IP address 192.168.1.33 and server **B** uses 192.168.1.34. Both servers use port 80. The letters a.b.c.d represent the WAN port's IP address. The ZyWALL translates port 8080 of traffic received on the WAN port (IP address a.b.c.d) to port 80 and sends it to server **A** (IP address 192.168.1.33). The ZyWALL also translates port 8100 of traffic received on the WAN port (also IP address a.b.c.d) to port 80, but sends it to server **B** (IP address 192.168.1.34).



In this example, anyone wanting to access server A from the Internet must use port 8080. Anyone wanting to access server B from the Internet must use port 8100.

Figure 206 Port Translation Example

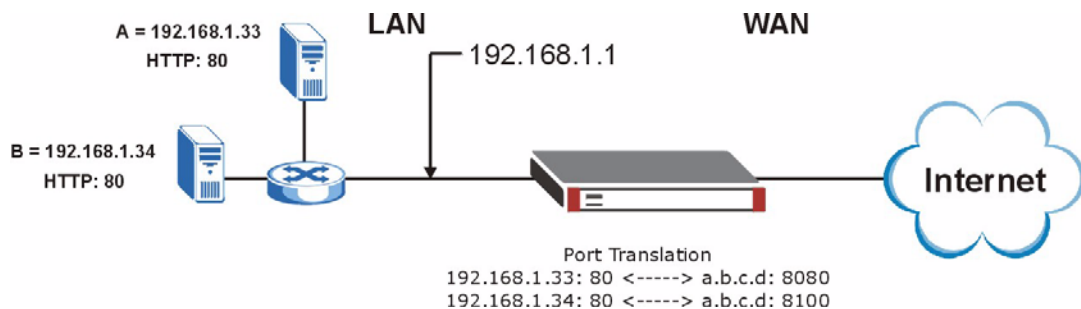

17.6 Port Forwarding Screen

Click **ADVANCED > NAT > Port Forwarding** to open the **Port Forwarding** screen.



If you do not assign a Default Server IP address, the ZyWALL discards all packets received for ports that are not specified here or in the remote management setup.

Refer to [Appendix E on page 615](#) for port numbers commonly used for particular services.



The last port forwarding rule is reserved for Roadrunner services. The rule is activated only when you set the WAN Encapsulation to Ethernet and the Service Type to something other than Standard.

Figure 207 ADVANCED > NAT > Port Forwarding

NAT

NAT Overview Address Mapping **Port Forwarding** Port Triggering

Port Forwarding Rules

Default Server: 0 . 0 . 0 . 0 Go To Page: 1

#	Active	Name	Incoming Port(s)	Port Translation	Server IP Address
1	<input checked="" type="checkbox"/>		80 - 80	0 - 0	192 . 168 . 1 . 39
2	<input checked="" type="checkbox"/>		25 - 25	0 - 0	192 . 168 . 1 . 12
3	<input type="checkbox"/>		0 - 0	0 - 0	0 . 0 . 0 . 0
4	<input type="checkbox"/>		0 - 0	0 - 0	0 . 0 . 0 . 0
5	<input type="checkbox"/>		0 - 0	0 - 0	0 . 0 . 0 . 0
6	<input type="checkbox"/>		0 - 0	0 - 0	0 . 0 . 0 . 0
7	<input type="checkbox"/>		0 - 0	0 - 0	0 . 0 . 0 . 0
8	<input type="checkbox"/>		0 - 0	0 - 0	0 . 0 . 0 . 0
9	<input type="checkbox"/>		0 - 0	0 - 0	0 . 0 . 0 . 0
10	<input type="checkbox"/>		0 - 0	0 - 0	0 . 0 . 0 . 0
11	<input type="checkbox"/>		0 - 0	0 - 0	0 . 0 . 0 . 0
12	<input type="checkbox"/>		0 - 0	0 - 0	0 . 0 . 0 . 0

Note 1: You may also need to create a [Firewall](#) rule.
Note 2: Port Translation is optional.

Apply Reset

The following table describes the labels in this screen.

Table 95 ADVANCED > NAT > Port Forwarding

LABEL	DESCRIPTION
Default Server	In addition to the servers for specified services, NAT supports a default server. A default server receives packets from ports that are not specified in this screen. If you do not assign a Default Server IP address, the ZyWALL discards all packets received for ports that are not specified here or in the remote management setup.
Go To Page	Choose a page from the drop-down list box to display the corresponding summary page of the port forwarding servers.
#	This is the number of an individual port forwarding server entry.
Active	Select this check box to enable the port forwarding server entry. Clear this check box to disallow forwarding of these ports to an inside server without having to delete the entry.
Name	Enter a name to identify this port-forwarding rule.
Incoming Port(s)	Enter a port number here. To forward only one port, enter it again in the second field. To specify a range of ports, enter the last port to be forwarded in the second field.
Port Translation	Enter the port number here to which you want the ZyWALL to translate the incoming port. For a range of ports, you only need to enter the first number of the range to which you want the incoming ports translated, the ZyWALL automatically calculates the last port of the translated port range.
Server IP Address	Enter the inside IP address of the server here.
Apply	Click Apply to save your changes back to the ZyWALL.
Reset	Click Reset to begin configuring this screen afresh.

17.7 Port Triggering

Some services use a dedicated range of ports on the client side and a dedicated range of ports on the server side. With regular port forwarding you set a forwarding port in NAT to forward a service (coming in from the server on the WAN) to the IP address of a computer on the client side (LAN). The problem is that port forwarding only forwards a service to a single LAN IP address. In order to use the same service on a different LAN computer, you have to manually replace the LAN computer's IP address in the forwarding port with another LAN computer's IP address.

Trigger port forwarding solves this problem by allowing computers on the LAN to dynamically take turns using the service. The ZyWALL records the IP address of a LAN computer that sends traffic to the WAN to request a service with a specific port number and protocol (a "trigger" port). When the ZyWALL's WAN port receives a response with a specific port number and protocol ("incoming" port), the ZyWALL forwards the traffic to the LAN IP address of the computer that sent the request. After that computer's connection for that service closes, another computer on the LAN can use the service in the same manner. This way you do not need to configure a new IP address each time you want a different LAN computer to use the application.

For example:

Figure 208 Trigger Port Forwarding Process: Example

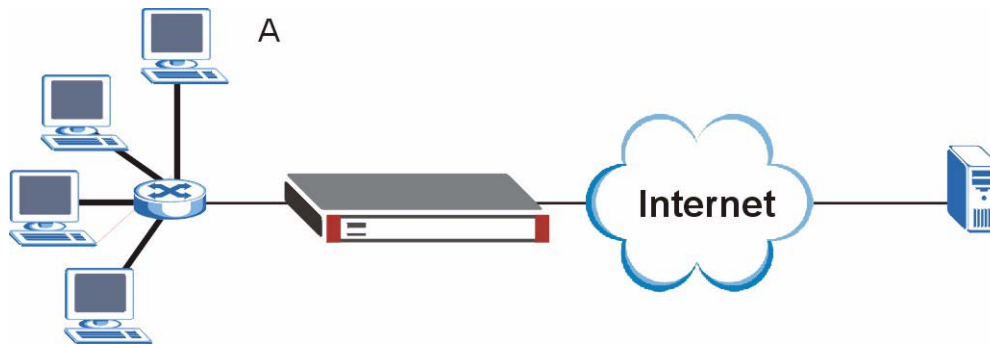

- 1 Jane (A) requests a file from the Real Audio server (port 7070).
- 2 Port 7070 is a "trigger" port and causes the ZyWALL to record Jane's computer IP address. The ZyWALL associates Jane's computer IP address with the "incoming" port range of 6970-7170.
- 3 The Real Audio server responds using a port number ranging between 6970-7170.
- 4 The ZyWALL forwards the traffic to Jane's computer IP address.
- 5 Only Jane can connect to the Real Audio server until the connection is closed or times out. The ZyWALL times out in three minutes with UDP (User Datagram Protocol) or two hours with TCP/IP (Transfer Control Protocol/Internet Protocol).

Click **ADVANCED > NAT > Port Triggering** to open the following screen. Use this screen to change your ZyWALL's trigger port settings.

Figure 209 ADVANCED > NAT > Port Triggering

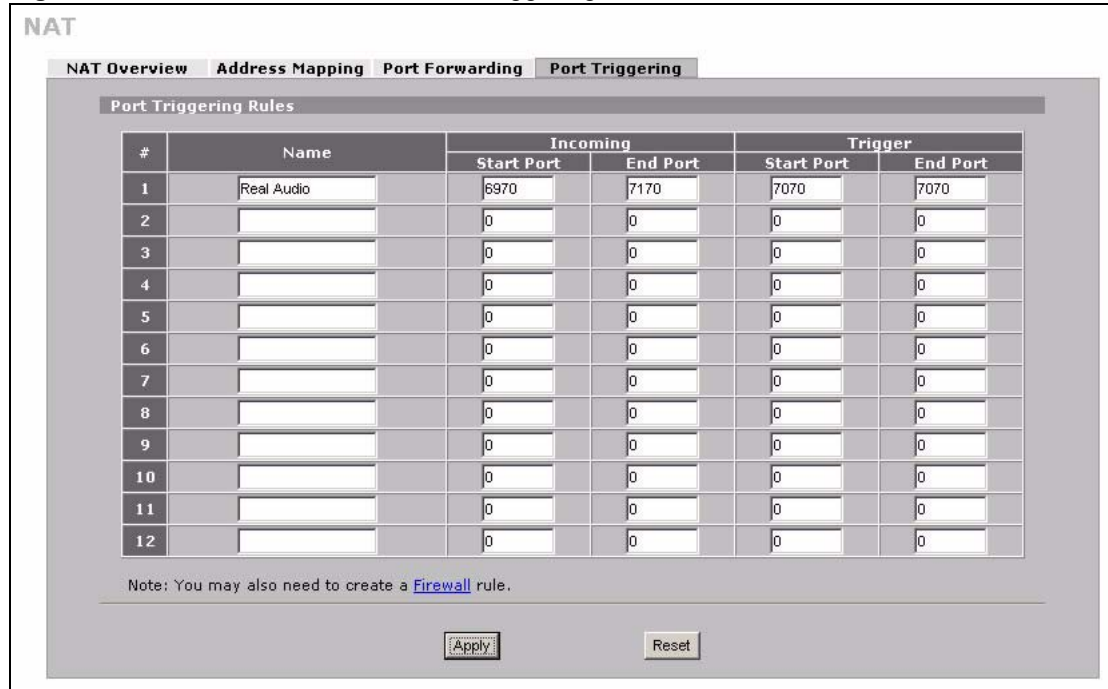

The following table describes the labels in this screen.

Table 96 ADVANCED > NAT > Port Triggering

LABEL	DESCRIPTION
#	This is the rule index number (read-only).
Name	Type a unique name (up to 15 characters) for identification purposes. All characters are permitted - including spaces.
Incoming	Incoming is a port (or a range of ports) that a server on the WAN uses when it sends out a particular service. The ZyWALL forwards the traffic with this port (or range of ports) to the client computer on the LAN that requested the service.
Start Port	Type a port number or the starting port number in a range of port numbers.
End Port	Type a port number or the ending port number in a range of port numbers.
Trigger	The trigger port is a port (or a range of ports) that causes (or triggers) the ZyWALL to record the IP address of the LAN computer that sent the traffic to a server on the WAN.
Start Port	Type a port number or the starting port number in a range of port numbers.
End Port	Type a port number or the ending port number in a range of port numbers.
Apply	Click Apply to save your changes back to the ZyWALL.
Reset	Click Reset to begin configuring this screen afresh.

Static Route

This chapter shows you how to configure static routes for your ZyWALL.

18.1 IP Static Route

Each remote node specifies only the network to which the gateway is directly connected, and the ZyWALL has no knowledge of the networks beyond. For instance, the ZyWALL knows about network N2 in the following figure through remote node Router 1. However, the ZyWALL is unable to route a packet to network N3 because it doesn't know that there is a route through the same remote node Router 1 (via gateway Router 2). The static routes are for you to tell the ZyWALL about the networks beyond the remote nodes.

Figure 210 Example of Static Routing Topology

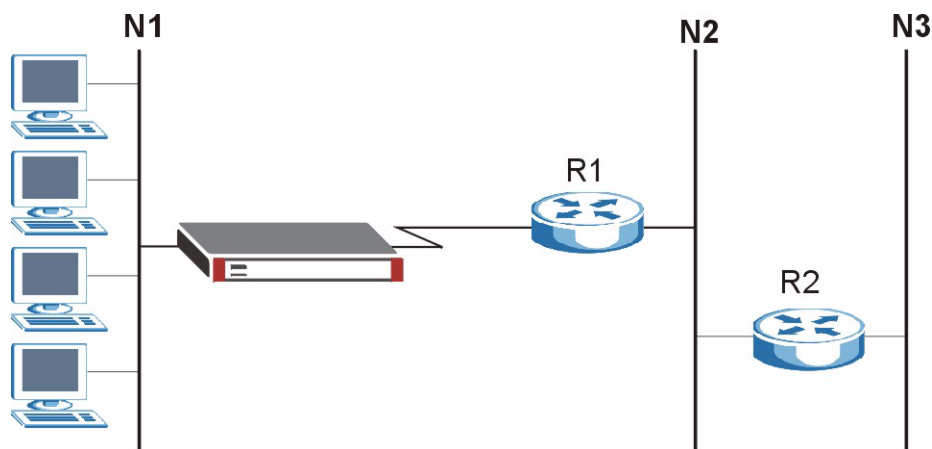

18.2 IP Static Route

Click **ADVANCED > STATIC ROUTE** to open the **IP Static Route** screen (some of the screen's blank rows are not shown).

The first static route entry is for the default WAN route. You cannot modify or delete a static default route.

The default route is disabled after you change the static WAN IP address to a dynamic WAN IP address.

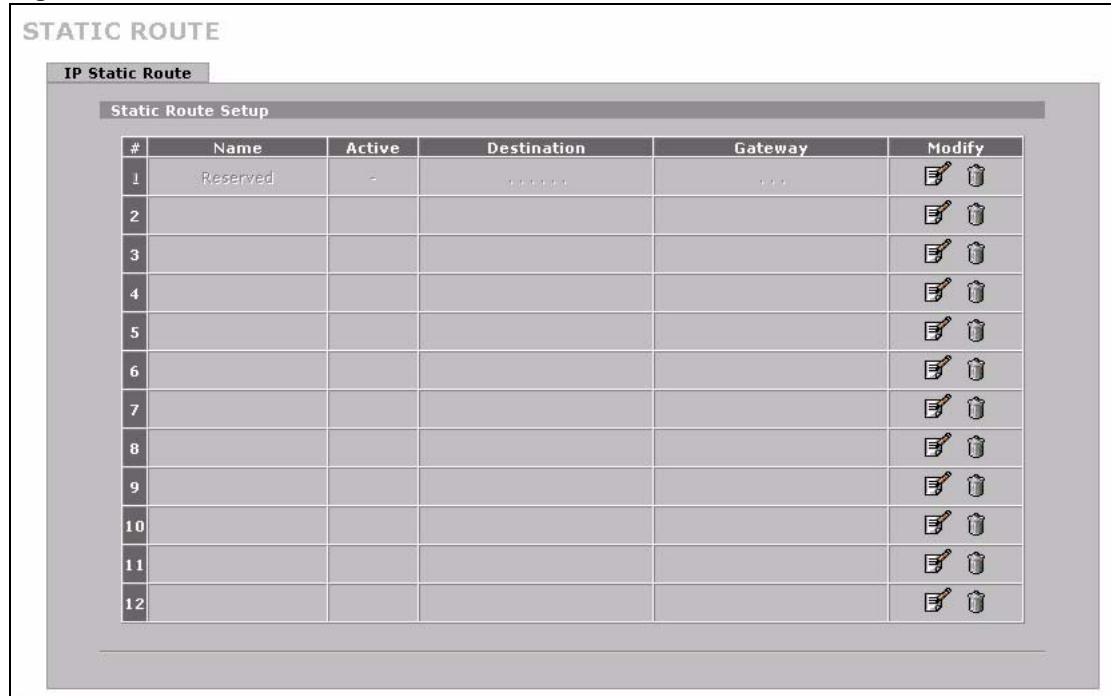
Figure 211 ADVANCED > STATIC ROUTE > IP Static Route

The following table describes the labels in this screen.

Table 97 ADVANCED > STATIC ROUTE > IP Static Route

LABEL	DESCRIPTION
#	This is the number of an individual static route.
Name	This is the name that describes or identifies this route.
Active	This field shows whether this static route is active (Yes) or not (No).
Destination	This parameter specifies the IP network address of the final destination. Routing is always based on network number.
Gateway	This is the IP address of the gateway. The gateway is a router or switch on the same network segment as the ZyWALL's interface. The gateway helps forward packets to their destinations.
Modify	Click the edit icon to go to the screen where you can set up a static route on the ZyWALL. Click the delete icon to remove a static route from the ZyWALL. A window displays asking you to confirm that you want to delete the route.

18.2.1 IP Static Route Edit

Select a static route index number and click **Edit**. The screen shown next appears. Use this screen to configure the required information for a static route.

Figure 212 ADVANCED > STATIC ROUTE > IP Static Route > Edit

The following table describes the labels in this screen.

Table 98 ADVANCED > STATIC ROUTE > IP Static Route > Edit

LABEL	DESCRIPTION
Route Name	Enter the name of the IP static route. Leave this field blank to delete this static route.
Active	This field allows you to activate/deactivate this static route.
Destination IP Address	This parameter specifies the IP network address of the final destination. Routing is always based on network number. If you need to specify a route to a single host, use a subnet mask of 255.255.255.255 in the subnet mask field to force the network number to be identical to the host ID.
IP Subnet Mask	Enter the IP subnet mask here.
Gateway IP Address	Enter the IP address of the gateway. The gateway is a router or switch on the same network segment as the device's LAN or WAN port. The gateway helps forward packets to their destinations.
Metric	Metric represents the "cost" of transmission for routing purposes. IP routing uses hop count as the measurement of cost, with a minimum of 1 for directly connected networks. Enter a number that approximates the cost for this link. The number need not be precise, but it must be between 1 and 15. In practice, 2 or 3 is usually a good number.
Private	This parameter determines if the ZyWALL will include this route to a remote node in its RIP broadcasts. Select this check box to keep this route private and not included in RIP broadcasts. Clear this check box to propagate this route to other hosts through RIP broadcasts.
Apply	Click Apply to save your changes back to the ZyWALL.
Cancel	Click Cancel to exit this screen without saving.

Bandwidth Management

This chapter describes the functions and configuration of bandwidth management with multiple levels of sub-classes.

19.1 Bandwidth Management Overview

Bandwidth management allows you to allocate an interface's outgoing capacity to specific types of traffic. It can also help you make sure that the ZyWALL forwards certain types of traffic (especially real-time applications) with minimum delay. With the use of real-time applications such as Voice-over-IP (VoIP) increasing, the requirement for bandwidth allocation is also increasing.

Bandwidth management addresses questions such as:

- Who gets how much access to specific applications?
- What priority level should you give to each type of traffic?
- Which traffic must have guaranteed delivery?
- How much bandwidth should be allotted to guarantee delivery?

Bandwidth management also allows you to configure the allowed output for an interface to match what the network can handle. This helps reduce delays and dropped packets at the next routing device. For example, you can set the WAN interface speed to 1024 kbps (or less) if the broadband device connected to the WAN port has an upstream speed of 1024 kbps.

19.2 Bandwidth Classes and Filters

Use bandwidth classes and sub-classes to allocate specific amounts of bandwidth capacity (bandwidth budgets). Configure a bandwidth filter to define a bandwidth class (or sub-class) based on a specific application and/or subnet. Use the **Class Setup** screen (see [Section 19.12.1 on page 333](#)) to set up a bandwidth class's name, bandwidth allotment, and bandwidth filter. You can configure up to one bandwidth filter per bandwidth class. You can also configure bandwidth classes without bandwidth filters. However, it is recommended that you configure sub-classes with filters for any classes that you configure without filters. The ZyWALL leaves the bandwidth budget allocated and unused for a class that does not have a filter or sub-classes with filters. View your configured bandwidth classes and sub-classes in the **Class Setup** screen (see [Section 19.12 on page 332](#) for details).

The total of the configured bandwidth budgets for sub-classes cannot exceed the configured bandwidth budget speed of the parent class.

19.3 Proportional Bandwidth Allocation

Bandwidth management allows you to define how much bandwidth each class gets; however, the actual bandwidth allotted to each class decreases or increases in proportion to actual available bandwidth.

19.4 Application-based Bandwidth Management

You can create bandwidth classes based on individual applications (like VoIP, Web, FTP, E-mail and Video for example).

19.5 Subnet-based Bandwidth Management

You can create bandwidth classes based on subnets.

The following figure shows LAN subnets. You could configure one bandwidth class for subnet A and another for subnet B.

Figure 213 Subnet-based Bandwidth Management Example

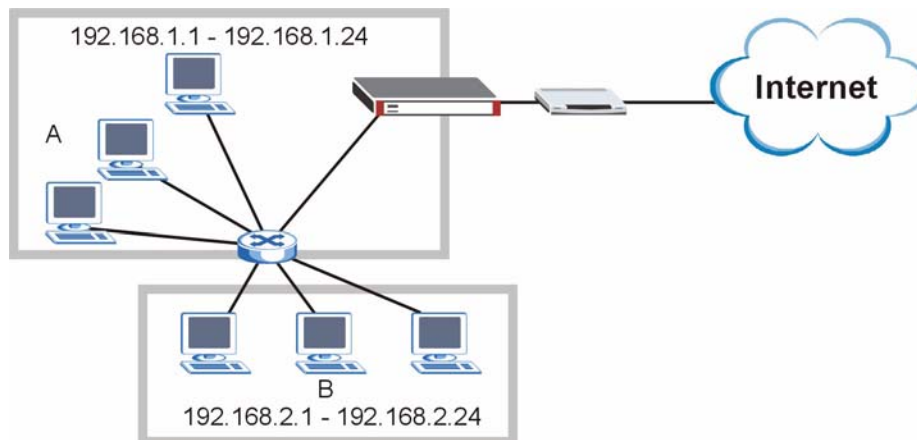

19.6 Application and Subnet-based Bandwidth Management

You could also create bandwidth classes based on a combination of a subnet and an application. The following example table shows bandwidth allocations for application specific traffic from separate LAN subnets.

Table 99 Application and Subnet-based Bandwidth Management Example

TRAFFIC TYPE	FROM SUBNET A	FROM SUBNET B
VoIP	64 Kbps	64 Kbps
Web	64 Kbps	64 Kbps
FTP	64 Kbps	64 Kbps
E-mail	64 Kbps	64 Kbps
Video	64 Kbps	64 Kbps

19.7 Scheduler

The scheduler divides up an interface's bandwidth among the bandwidth classes. The ZyWALL has two types of scheduler: fairness-based and priority-based.

19.7.1 Priority-based Scheduler

With the priority-based scheduler, the ZyWALL forwards traffic from bandwidth classes according to the priorities that you assign to the bandwidth classes. The larger a bandwidth class's priority number is, the higher the priority. Assign real-time applications (like those using audio or video) a higher priority number to provide smoother operation.

19.7.2 Fairness-based Scheduler

The ZyWALL divides bandwidth equally among bandwidth classes when using the fairness-based scheduler; thus preventing one bandwidth class from using all of the interface's bandwidth.

19.7.3 Maximize Bandwidth Usage

The maximize bandwidth usage option allows the ZyWALL to divide up any available bandwidth on the interface (including unallocated bandwidth and any allocated bandwidth that a class is not using) among the bandwidth classes that require more bandwidth.

When you enable maximize bandwidth usage, the ZyWALL first makes sure that each bandwidth class gets up to its bandwidth allotment. Next, the ZyWALL divides up an interface's available bandwidth (bandwidth that is unbudgeted or unused by the classes) depending on how many bandwidth classes require more bandwidth and on their priority levels. When only one class requires more bandwidth, the ZyWALL gives extra bandwidth to that class.

When multiple classes require more bandwidth, the ZyWALL gives the highest priority classes the available bandwidth first (as much as they require, if there is enough available bandwidth), and then to lower priority classes if there is still bandwidth available. The ZyWALL distributes the available bandwidth equally among classes with the same priority level.

19.7.4 Reserving Bandwidth for Non-Bandwidth Class Traffic

Do the following three steps to configure the ZyWALL to allow bandwidth for traffic that is not defined in a bandwidth filter.

- 1 Leave some of the interface's bandwidth unbudgeted.
- 2 Do not enable the interface's **Maximize Bandwidth Usage** option.
- 3 Do not enable bandwidth borrowing on the sub-classes that have the root class as their parent (see [Section 19.8 on page 329](#)).

19.7.5 Maximize Bandwidth Usage Example

Here is an example of a ZyWALL that has maximize bandwidth usage enabled on an interface. The following table shows each bandwidth class's bandwidth budget. The classes are set up based on subnets. The interface is set to 10240 kbps. Each subnet is allocated 2048 kbps. The unbudgeted 2048 kbps allows traffic not defined in any of the bandwidth filters to go out when you do not select the maximize bandwidth option.

Table 100 Maximize Bandwidth Usage Example

BANDWIDTH CLASSES AND ALLOTMENTS	
Root Class: 10240 kbps	Administration: 2048 kbps
	Sales: 2048 kbps
	Marketing: 2048 kbps
	Research: 2048 kbps

The ZyWALL divides up the unbudgeted 2048 kbps among the classes that require more bandwidth. If the administration department only uses 1024 kbps of the budgeted 2048 kbps, the ZyWALL also divides the remaining 1024 kbps among the classes that require more bandwidth. Therefore, the ZyWALL divides a total of 3072 kbps of unbudgeted and unused bandwidth among the classes that require more bandwidth.

19.7.5.1 Priority-based Allotment of Unused and Unbudgeted Bandwidth

The following table shows the priorities of the bandwidth classes and the amount of bandwidth that each class gets.

Table 101 Priority-based Allotment of Unused and Unbudgeted Bandwidth Example

BANDWIDTH CLASSES, PRIORITIES AND ALLOTMENTS	
Root Class: 10240 kbps	Administration: Priority 4, 1024 kbps
	Sales: Priority 6, 3584 kbps
	Marketing: Priority 6, 3584 kbps
	Research: Priority 5, 2048 kbps

Suppose that all of the classes except for the administration class need more bandwidth.

- Each class gets up to its budgeted bandwidth. The administration class only uses 1024 kbps of its budgeted 2048 kbps.
- The sales and marketing are first to get extra bandwidth because they have the highest priority (6). If they each require 1536 kbps or more of extra bandwidth, the ZyWALL divides the total 3072 kbps total of unbudgeted and unused bandwidth equally between the sales and marketing departments (1536 kbps extra to each for a total of 3584 kbps for each) because they both have the highest priority level.
- Research requires more bandwidth but only gets its budgeted 2048 kbps because all of the unbudgeted and unused bandwidth goes to the higher priority sales and marketing classes.

19.7.5.2 Fairness-based Allotment of Unused and Unbudgeted Bandwidth

The following table shows the amount of bandwidth that each class gets.

Table 102 Fairness-based Allotment of Unused and Unbudgeted Bandwidth Example

BANDWIDTH CLASSES AND ALLOTMENTS	
Root Class: 10240 kbps	Administration: 1024 kbps
	Sales: 3072 kbps
	Marketing: 3072 kbps
	Research: 3072 kbps

Suppose that all of the classes except for the administration class need more bandwidth.

- Each class gets up to its budgeted bandwidth. The administration class only uses 1024 kbps of its budgeted 2048 kbps.
- The ZyWALL divides the total 3072 kbps total of unbudgeted and unused bandwidth equally among the other classes. 1024 kbps extra goes to each so the other classes each get a total of 3072 kbps.

19.8 Bandwidth Borrowing

Bandwidth borrowing allows a sub-class to borrow unused bandwidth from its parent class, whereas maximize bandwidth usage allows bandwidth classes to borrow any unused or unbudgeted bandwidth on the whole interface.

Enable bandwidth borrowing on a sub-class to allow the sub-class to use its parent class's unused bandwidth. A parent class's unused bandwidth is given to the highest priority sub-class first. The sub-class can also borrow bandwidth from a higher parent class (grandparent class) if the sub-class's parent class is also configured to borrow bandwidth from its parent class. This can go on for as many levels as are configured to borrow bandwidth from their parent class (see [Section 19.8.1 on page 329](#)).

The total of the bandwidth allotments for sub-classes cannot exceed the bandwidth allotment of their parent class. The ZyWALL uses the scheduler to divide a parent class's unused bandwidth among the sub-classes.

19.8.1 Bandwidth Borrowing Example

Here is an example of bandwidth management with classes configured for bandwidth borrowing. The classes are set up based on departments and individuals within certain departments.

Refer to the product specifications in the appendix to see how many class levels you can configure on your ZyWALL.

Table 103 Bandwidth Borrowing Example

BANDWIDTH CLASSES AND BANDWIDTH BORROWING SETTINGS	
Root Class:	Administration: Borrowing Enabled
	Sales: Borrowing Disabled
	Marketing: Borrowing Enabled
	Research: Borrowing Enabled

- The Administration class can borrow unused bandwidth from the Root class because the Administration class has bandwidth borrowing enabled.
- The Sales class cannot borrow unused bandwidth from the Root class because the Sales class has bandwidth borrowing disabled.

19.9 Maximize Bandwidth Usage With Bandwidth Borrowing

If you configure both maximize bandwidth usage (on the interface) and bandwidth borrowing (on individual sub-classes), the ZyWALL functions as follows.

- 1 The ZyWALL sends traffic according to each bandwidth class's bandwidth budget.
- 2 The ZyWALL assigns a parent class's unused bandwidth to its sub-classes that have more traffic than their budgets and have bandwidth borrowing enabled. The ZyWALL gives priority to sub-classes of higher priority and treats classes of the same priority equally.
- 3 The ZyWALL assigns any remaining unused or unbudgeted bandwidth on the interface to any class that requires it. The ZyWALL gives priority to classes of higher priority and treats classes of the same level equally.
- 4 If the bandwidth requirements of all of the traffic classes are met and there is still some unbudgeted bandwidth, the ZyWALL assigns it to traffic that does not match any of the classes.

19.10 Over Allotment of Bandwidth

It is possible to set the bandwidth management speed for an interface higher than the interface's actual transmission speed. Higher priority traffic gets to use up to its allocated bandwidth, even if it takes up all of the interface's available bandwidth. This could stop lower priority traffic from being sent. The following is an example.

Table 104 Over Allotment of Bandwidth Example

BANDWIDTH CLASSES, ALLOTMENTS		PRIORITIES
Actual outgoing bandwidth available on the interface: 1000 kbps		
Root Class: 1500 kbps (same as Speed setting)	VoIP traffic (Service = SIP): 500 Kbps	7
	NetMeeting traffic (Service = H.323): 500 kbps	7
	FTP (Service = FTP): 500 Kbps	3

If you use VoIP and NetMeeting at the same time, the device allocates up to 500 Kbps of bandwidth to each of them before it allocates any bandwidth to FTP. As a result, FTP can only use bandwidth when VoIP and NetMeeting do not use all of their allocated bandwidth.

Suppose you try to browse the web too. In this case, VoIP, NetMeeting and FTP all have higher priority, so they get to use the bandwidth first. You can only browse the web when VoIP, NetMeeting, and FTP do not use all 1000 Kbps of available bandwidth.

19.11 Configuring Summary

Click **ADVANCED > BW MGMT** to open the **Summary** screen.

Enable bandwidth management on an interface and set the maximum allowed bandwidth for that interface.

Figure 214 ADVANCED > BW MGMT > Summary

Class	Active	Speed (kbps)	Scheduler	Maximize Bandwidth Usage
WAN	<input checked="" type="checkbox"/>	100000	Priority-Based	<input type="checkbox"/>
LAN	<input type="checkbox"/>	100000	Fairness-Based	<input type="checkbox"/>
DMZ	<input type="checkbox"/>	100000	Fairness-Based	<input type="checkbox"/>
WLAN	<input type="checkbox"/>	100000	Fairness-Based	<input type="checkbox"/>

The following table describes the labels in this screen.

Table 105 ADVANCED > BW MGMT > Summary

LABEL	DESCRIPTION
Class	These read-only labels represent the physical interfaces. Select an interface's check box to enable bandwidth management on that interface. Bandwidth management applies to all traffic flowing out of the router through the interface, regardless of the traffic's source. Traffic redirect or IP alias may cause LAN-to-LAN or DMZ-to-DMZ traffic to pass through the ZyWALL and be managed by bandwidth management.
Active	Select an interface's check box to enable bandwidth management on that interface.
Speed (kbps)	Enter the amount of bandwidth for this interface that you want to allocate using bandwidth management. This appears as the bandwidth budget of the interface's root class (see Section 19.12 on page 332). The recommendation is to set this speed to match the interface's actual transmission speed. For example, set the WAN interface speed to 1000 kbps if your Internet connection has an upstream transmission speed of 1 Mbps. You can set this number higher than the interface's actual transmission speed. This will stop lower priority traffic from being sent if higher priority traffic uses all of the actual bandwidth. You can also set this number lower than the interface's actual transmission speed. If you do not enable Maximize Bandwidth Usage , this will cause the ZyWALL to not use some of the interface's available bandwidth.

Table 105 ADVANCED > BW MGMT > Summary (continued)

LABEL	DESCRIPTION
Scheduler	Select either Priority-Based or Fairness-Based from the drop-down menu to control the traffic flow. Select Priority-Based to give preference to bandwidth classes with higher priorities. Select Fairness-Based to treat all bandwidth classes equally. See Section 19.7 on page 327 .
Maximize Bandwidth Usage	Select this check box to have the ZyWALL divide up all of the interface's unallocated and/or unused bandwidth among the bandwidth classes that require bandwidth. Do not select this if you want to reserve bandwidth for traffic that does not match a bandwidth class (see Section 19.7.4 on page 327) or you want to limit the speed of this interface (see the Speed field description).
Apply	Click Apply to save your changes back to the ZyWALL.
Reset	Click Reset to begin configuring this screen afresh.

19.12 Configuring Class Setup

The **Class Setup** screen displays the configured bandwidth classes by individual interface. Select an interface and click the buttons to perform the actions described next. Click “+” to expand the class tree or click “-” to collapse the class tree. Each interface has a permanent root class. The bandwidth budget of the root class is equal to the speed you configured on the interface (see [Section 19.11 on page 331](#) to configure the speed of the interface). Configure sub-class layers for the root class.

To add or delete child classes on an interface, click **ADVANCED > BW MGMT > Class Setup**. The screen is shown here with example classes.

Figure 215 ADVANCED > BW MGMT > Class Setup

The screenshot shows the 'BANDWIDTH MANAGEMENT' interface with the 'Class Setup' tab selected. The interface is set to 'LAN' and 'Bandwidth Management: Active'. A class tree is displayed with a root class of 100000 kbps and three sub-classes: Admin (15000 kbps), R/D (20000 kbps), and Sales (20000 kbps). Below the tree are buttons for 'Add Sub-Class', 'Edit', 'Delete', and 'Statistics'. A 'Filter List' table is shown below, listing filters for Admin and R/D services. At the bottom, there is a 'Move filter' option.

#	Filter Name	Service	Destination IP Address	Destination Port	Source IP Address	Source Port	Protocol ID
1	Admin	n/a	0.0.0.0/0	0	192.168.1.10/24	0	0
2	R/D	n/a	0.0.0.0/0	0	192.168.2.3/24	0	0

Move filter 0 to filter 0 (filter number).

The following table describes the labels in this screen.

Table 106 ADVANCED > BW MGMT > Class Setup

LABEL	DESCRIPTION
Interface	Select an interface for which you want to set up bandwidth management classes. Bandwidth management controls outgoing traffic on an interface, not incoming. So, in order to limit the download bandwidth of the LAN users, set the bandwidth management class on the LAN. In order to limit the upload bandwidth, set the bandwidth management class on the corresponding WAN interface.
Bandwidth Management	This field displays whether bandwidth management on the interface you selected in the field above is enabled (Active) or not (Inactive).
	After you select an interface, the bandwidth management classes configured for the interface display. The name and bandwidth display for each class.
Add Sub-Class	Click Add Sub-class to add a sub-class.
Edit	Click Edit to configure the selected class. You cannot edit the root class.
Delete	Click Delete to delete the class and all its sub-classes. You cannot delete the root class.
Statistics	Click Statistics to display the status of the selected class.
Filter List	This list displays the active bandwidth management filters that are configured for the classes on the selected interface. The ZyWALL applies the bandwidth management filters in the order that they appear here. Once a connection matches a bandwidth management filter, the ZyWALL applies the rules of the corresponding bandwidth management class and does not check the connection against any other bandwidth management filters.
#	This is the index number of an individual bandwidth management filter.
Filter Name	This is the name that identifies a bandwidth management filter.
Service	This is the service that this bandwidth management filter is configured to manage.
Destination IP Address	This is the destination IP address for connections to which this bandwidth management filter applies.
Destination Port	This is the destination port for connections to which this bandwidth management filter applies.
Source IP Address	This is the source IP address for connections to which this bandwidth management filter applies.
Source Port	This is the source port for connections to which this bandwidth management filter applies.
Protocol ID	This is the protocol ID (service type) number for connections to which this bandwidth management filter applies. For example: 1 for ICMP, 6 for TCP or 17 for UDP.
Move	Type a filter's index number and the number for where you want to put that filter. Click Move to move the filter to the number that you typed. The ordering of your filters is important as they are applied in order of their numbering.

19.12.1 Bandwidth Manager Class Configuration

Configure a bandwidth management class in the **Class Setup** screen. You must use the **Summary** screen to enable bandwidth management on an interface before you can configure classes for that interface.

Click **ADVANCED > BW MGMT > Class Setup > Add Sub-Class** or **Edit** to open the following screen. Use this screen to add a child class.

Figure 216 ADVANCED > BW MGMT > Class Setup > Add Sub-Class

The following table describes the labels in this screen.

Table 107 ADVANCED > BW MGMT > Class Setup > Add Sub-Class

LABEL	DESCRIPTION
Class Configuration	
Class Name	Use the auto-generated name or enter a descriptive name of up to 20 alphanumeric characters, including spaces.
Bandwidth Budget (kbps)	Specify the maximum bandwidth allowed for the class in kbps. The recommendation is a setting between 20 kbps and 20000 kbps for an individual class.
Priority	Enter a number between 0 and 7 to set the priority of this class. The higher the number, the higher the priority. The default setting is 3.
Borrow bandwidth from parent class	Select this option to allow a sub-class to borrow bandwidth from its parent class if the parent class is not using up its bandwidth budget. Bandwidth borrowing is governed by the priority of the sub-classes. That is, a sub-class with the highest priority (7) is the first to borrow bandwidth from its parent class. Do not select this for the classes directly below the root class if you want to leave bandwidth available for other traffic types (see Section 19.7.4 on page 327) or you want to set the interface's speed to match what the next device in network can handle (see the Speed field description in Table 105 on page 331).
Filter Configuration	
Enable Bandwidth Filter	Select Enable Bandwidth Filter to have the ZyWALL use this bandwidth filter when it performs bandwidth management. You must enter a value in at least one of the following fields (other than the Subnet Mask fields which are only available when you enter the destination or source IP address).

Table 107 ADVANCED > BW MGMT > Class Setup > Add Sub-Class (continued)

LABEL	DESCRIPTION
Service	<p>This field simplifies bandwidth class configuration by allowing you to select a predefined application. When you select a predefined application, you do not configure the rest of the bandwidth filter fields (other than enabling or disabling the filter).</p> <p>FTP (File Transfer Program) is a program to enable fast transfer of files, including large files that may not be possible by e-mail. Select FTP from the drop-down list box to configure the bandwidth filter for TCP packets with a port 21 destination.</p> <p>H.323 is a protocol used for multimedia communications over networks, for example NetMeeting. Select H.323 from the drop-down list box to configure the bandwidth filter for TCP packets with a port 1720 destination.</p> <p>Note: If you select H.323, make sure you also use the ALG screen to turn on the H.323 ALG.</p> <p>SIP (Session Initiation Protocol) is a signaling protocol used in Internet telephony, instant messaging, events notification and conferencing. The ZyWALL supports SIP traffic pass-through. Select SIP from the drop-down list box to configure this bandwidth filter for UDP packets with a port 5060 destination. This option makes it easier to manage bandwidth for SIP traffic and is useful for example when there is a VoIP (Voice over Internet Protocol) device on your LAN.</p> <p>Note: If you select SIP, make sure you also use the ALG screen to turn on the SIP ALG.</p> <p>Select Custom from the drop-down list box if you do not want to use a predefined application for the bandwidth class. When you select Custom, you need to configure at least one of the following fields (other than the Subnet Mask fields which you only enter if you also enter a corresponding destination or source IP address).</p>
Destination IP Address	Enter the destination IP address in dotted decimal notation.
Destination Subnet Mask	Enter the destination subnet mask. Refer to Appendix E on page 694 for more information on IP subnetting.
Destination Port	Enter the port number of the destination. See Section 11.11.2 on page 233 for a table of services and port numbers.
Source IP Address	Enter the source IP address.
Source Subnet Mask	Enter the source subnet mask. Refer to Appendix E on page 694 for more information on IP subnetting.
Source Port	Enter the port number of the source. See the following table for some common services and port numbers.
Protocol ID	Enter the protocol ID (service type) number, for example: 1 for ICMP, 6 for TCP or 17 for UDP.
Apply	Click Apply to save your changes back to the ZyWALL.
Cancel	Click Cancel to exit this screen without saving.

Table 108 Services and Port Numbers

SERVICES	PORT NUMBER
ECHO	7
FTP (File Transfer Protocol)	21
SMTP (Simple Mail Transfer Protocol)	25
DNS (Domain Name System)	53
Finger	79
HTTP (Hyper Text Transfer protocol or WWW, Web)	80
POP3 (Post Office Protocol)	110
NNTP (Network News Transport Protocol)	119
SNMP (Simple Network Management Protocol)	161
SNMP trap	162
PPTP (Point-to-Point Tunneling Protocol)	1723

19.12.2 Bandwidth Management Statistics

Click **ADVANCED > BW MGMT > Class Setup > Statistics** to open the **Bandwidth Management Statistics** screen. This screen displays the selected bandwidth class's bandwidth usage and allotments.

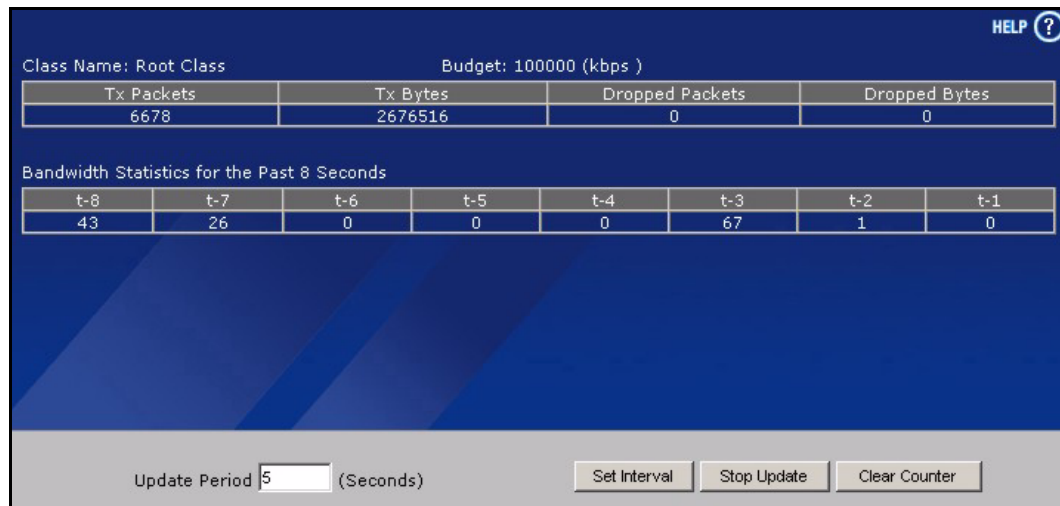
Figure 217 ADVANCED > BW MGMT > Class Setup > Statistics

The following table describes the labels in this screen.

LABEL	DESCRIPTION
Class Name	This field displays the name of the class the statistics page is showing.
Budget (kbps)	This field displays the amount of bandwidth allocated to the class.
Tx Packets	This field displays the total number of packets transmitted.
Tx Bytes	This field displays the total number of bytes transmitted.
Dropped Packets	This field displays the total number of packets dropped.

LABEL	DESCRIPTION
Dropped Bytes	This field displays the total number of bytes dropped.
Bandwidth Statistics for the Past 8 Seconds (t-8 to t-1)	
This field displays the bandwidth statistics (in bps) for the past one to eight seconds. For example, t-1 means one second ago.	
Update Period (Seconds)	Enter the time interval in seconds to define how often the information should be refreshed.
Set Interval	Click Set Interval to apply the new update period you entered in the Update Period field above.
Stop Update	Click Stop Update to stop the browser from refreshing bandwidth management statistics.
Clear Counter	Click Clear Counter to clear all of the bandwidth management statistics.

19.13 Bandwidth Manager Monitor

Click **ADVANCED > BW MGMT > Monitor** to open the following screen. Use this screen to view the device's bandwidth usage and allotments.

Figure 218 ADVANCED > BW MGMT > Monitor

Class	Budget (kbps)	Current Usage (kbps)
Root Class	100000	79
Admin	15000	78
R/D	20000	0
Sales	20000	0
Default Class	45000	0

The following table describes the labels in this screen.

LABEL	DESCRIPTION
Interface	Select an interface from the drop-down list box to view the bandwidth usage of its bandwidth classes.
Class	This field displays the name of the bandwidth class. A Default Class automatically displays for all the bandwidth in the Root Class that is not allocated to bandwidth classes. If you do not enable maximize bandwidth usage on an interface, the ZyWALL uses the bandwidth in this default class to send traffic that does not match any of the bandwidth classes. ^A
Budget (kbps)	This field displays the amount of bandwidth allocated to the bandwidth class.
Current Usage (kbps)	This field displays the amount of bandwidth that each bandwidth class is using.
Refresh	Click Refresh to update the page.

A. If you allocate all the root class's bandwidth to the bandwidth classes, the default class still displays a budget of 2 kbps (the minimum amount of bandwidth that can be assigned to a bandwidth class).

This chapter shows you how to configure the DNS screens.

20.1 DNS Overview

DNS (Domain Name System) is for mapping a domain name to its corresponding IP address and vice versa. The DNS server is extremely important because without it, you must know the IP address of a machine before you can access it. The ZyWALL uses a system DNS server (in the order you specify in the **DNS System** screen) to resolve domain names, for example, VPN, DDNS and the time server.

20.2 DNS Server Address Assignment

The ZyWALL can get the DNS server addresses in the following ways.

- 1 The ISP tells you the DNS server addresses, usually in the form of an information sheet, when you sign up. If your ISP gives you DNS server addresses, manually enter them in the DNS server fields.
- 2 If your ISP dynamically assigns the DNS server IP addresses (along with the ZyWALL's WAN IP address), set the DNS server fields to get the DNS server address from the ISP.
- 3 You can manually enter the IP addresses of other DNS servers. These servers can be public or private. A DNS server could even be behind a remote IPSec router (see [Section 20.5.1 on page 340](#)).

20.3 DNS Servers

There are three places where you can configure DNS setup on the ZyWALL.

- 1 Use the **DNS System** screen to configure the ZyWALL to use a DNS server to resolve domain names for ZyWALL system features like VPN, DDNS and the time server.
- 2 Use the **DNS DHCP** screen to configure the DNS server information that the ZyWALL sends to the DHCP client devices on the LAN, DMZ or WLAN.
- 3 Use the **REMOTE MGMT DNS** screen to configure the ZyWALL (in router mode) to accept or discard DNS queries.

20.4 Address Record

An address record contains the mapping of a fully qualified domain name (FQDN) to an IP address. An FQDN consists of a host and domain name and includes the top-level domain. For example, `www.zyxel.com.tw` is a fully qualified domain name, where “www” is the host, “zyxel” is the second-level domain, and “com.tw” is the top level domain. `mail.myZyXEL.com.tw` is also a FQDN, where “mail” is the host, “myZyXEL” is the second-level domain, and “com.tw” is the top level domain.

The ZyWALL allows you to configure address records about the ZyWALL itself or another device. This way you can keep a record of DNS names and addresses that people on your network may use frequently. If the ZyWALL receives a DNS query for an FQDN for which the ZyWALL has an address record, the ZyWALL can send the IP address in a DNS response without having to query a DNS name server.

20.4.1 DNS Wildcard

Enabling the wildcard feature for your host causes `*.yourhost.com` to be aliased to the same IP address as `yourhost.com`. This feature is useful if you want to be able to use, for example, `www.yourhost.com` and still reach your hostname.

20.5 Name Server Record

A name server record contains a DNS server’s IP address. The ZyWALL can query the DNS server to resolve domain names for features like VPN, DDNS and the time server. A domain zone may also be included. A domain zone is a fully qualified domain name without the host. For example, `zyxel.com.tw` is the domain zone for the `www.zyxel.com.tw` fully qualified domain name.

20.5.1 Private DNS Server

In cases where you want to use domain names to access Intranet servers on a remote private network that has a DNS server, you must identify that DNS server. You cannot use DNS servers on the LAN or from the ISP since these DNS servers cannot resolve domain names to private IP addresses on the remote private network.

The following figure depicts an example where three VPN tunnels are created from ZyWALL A; one to branch office **2**, one to branch office **3** and another to headquarters (**HQ**). In order to access computers that use private domain names on the **HQ** network, the ZyWALL at branch office **1** uses the Intranet DNS server in headquarters.

Figure 219 Private DNS Server Example

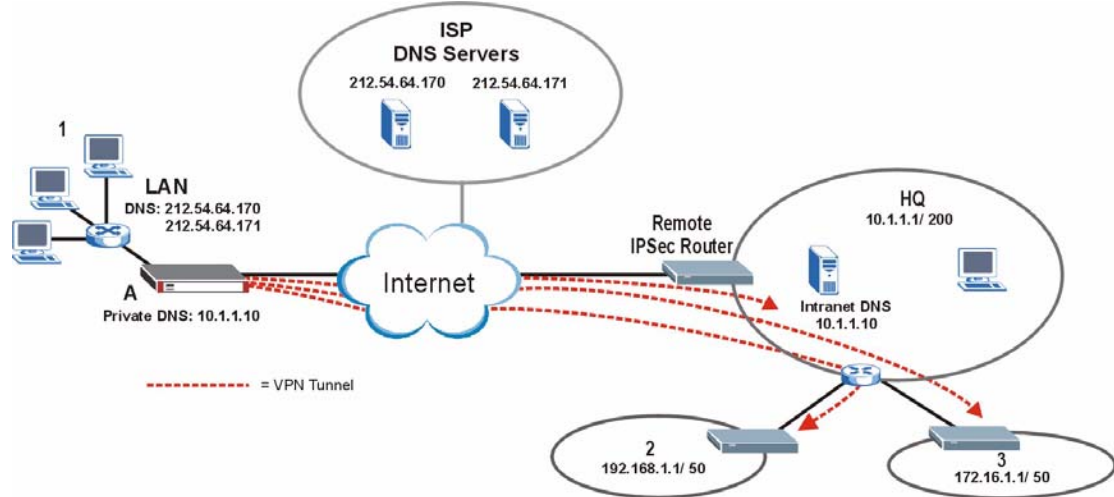

If you do not specify an Intranet DNS server on the remote network, then the VPN host must use IP addresses to access the computers on the remote private network.

20.6 System Screen

Click **ADVANCED > DNS** to display the following screen. Use this screen to configure your ZyWALL's DNS address and name server records.

Figure 220 ADVANCED > DNS > System DNS

DNS

System Cache DHCP DDNS

Address Record

#	FQDN	Wildcard	IP Address	Modify
1	mail.zyxel.com.tw	No	172.23.5.5	
2	www.zyxel.com.tw	Yes	172.23.37.114 (WAN)	

Add

Name Server Record

#	Domain Zone	From	DNS Server	Modify
1	nctu.edu.tw	User-Defined	140.113.68.10	
-	*	Default	172.23.5.1 172.23.5.2	N/A

Insert new record before record 1 (record number)

The following table describes the labels in this screen.

LABEL	DESCRIPTION
Address Record	An address record specifies the mapping of a fully qualified domain name (FQDN) to an IP address. An FQDN consists of a host and domain name and includes the top-level domain. For example, www.zyxel.com.tw is a fully qualified domain name, where “www” is the host, “zyxel” is the second-level domain, and “com.tw” is the top level domain.
#	This is the index number of the address record.
FQDN	This is a host’s fully qualified domain name.
Wildcard	This column displays whether or not the DNS wildcard feature is enabled for this domain name.
IP Address	This is the IP address of a host.
Modify	Click the edit icon to go to the screen where you can edit the record. Click the delete icon to remove an existing record. A window display asking you to confirm that you want to delete the record. Note that subsequent records move up by one when you take this action.
Add	Click Add to open a screen where you can add a new address record. Refer to Table 109 on page 343 for information on the fields.
Name Server Record	A name server record contains a DNS server’s IP address. The ZyWALL can query the DNS server to resolve domain names for features like VPN, DDNS and the time server. When the ZyWALL needs to resolve a domain name, it checks it against the name server record entries in the order that they appear in this list. A “*” indicates a name server record without a domain zone. The default record is grayed out. The ZyWALL uses this default record if the domain name that needs to be resolved does not match any of the other name server records. A name server record with a domain zone is always put before a record without a domain zone.
#	This is the index number of the name server record.
Domain Zone	A domain zone is a fully qualified domain name without the host. For example, zyxel.com.tw is the domain zone for the www.zyxel.com.tw fully qualified domain name.
From	This field displays whether the IP address of a DNS server is from a WAN interface (and which it is) or specified by the user.
DNS Server	This is the IP address of a DNS server.
Modify	Click a triangle icon to move the record up or down in the list. Click the edit icon to go to the screen where you can edit the record. Click the delete icon to remove an existing record. A window display asking you to confirm that you want to delete the record. Note that subsequent records move up by one when you take this action.
Insert	Enter the rule number where you want to put the record and click Insert to open a screen where you can configure a new name server record. Refer to Table 112 on page 344 for information on the fields.

20.6.1 Adding an Address Record

Click **Add** in the **System** screen to open this screen. Use this screen to add an address record.

An address record contains the mapping of a fully qualified domain name (FQDN) to an IP address. Configure address records about the ZyWALL itself or another device to keep a record of DNS names and addresses that people on your network may use frequently. If the ZyWALL receives a DNS query for an FQDN for which the ZyWALL has an address record, the ZyWALL can send the IP address in a DNS response without having to query a DNS name server. See [Section 20.4 on page 340](#) for more on address records.

Figure 221 ADVANCED > DNS > Add (Address Record)

The following table describes the labels in this screen.

Table 109 ADVANCED > DNS > Add (Address Record)

LABEL	DESCRIPTION
FQDN	Type a fully qualified domain name (FQDN) of a server. An FQDN starts with a host name and continues all the way up to the top-level domain name. For example, www.zyxel.com.tw is a fully qualified domain name, where “www” is the host, “zyxel” is the second-level domain, and “com.tw” is the top level domain.
IP Address	If this entry is for the WAN port on the ZyWALL, select WAN Interface . For entries that are not for the WAN port, select Custom and enter the IP address of the host in dotted decimal notation.
Enable Wildcard	Select the check box to enable DNS wildcard.
Apply	Click Apply to save your changes back to the ZyWALL.
Cancel	Click Cancel to exit this screen without saving.

20.6.2 Inserting a Name Server Record

Click **Insert** in the **System** screen to open this screen. Use this screen to insert a name server record.

Figure 222 ADVANCED > DNS > Insert (Name Server Record)

The following table describes the labels in this screen.

LABEL	DESCRIPTION
Domain Zone	<p>This field is optional.</p> <p>A domain zone is a fully qualified domain name without the host. For example, zyxel.com.tw is the domain zone for the www.zyxel.com.tw fully qualified domain name. For example, whenever the ZyWALL receives needs to resolve a zyxel.com.tw domain name, it can send a query to the recorded name server IP address.</p> <p>Leave this field blank if all domain zones are served by the specified DNS server(s).</p>
DNS Server	<p>Select the DNS Server(s) from ISP radio button if your ISP dynamically assigns DNS server information. The fields below display the (read-only) DNS server IP address(es) that the ISP assigns. N/A displays for any DNS server IP address fields for which the ISP does not assign an IP address. N/A displays for all of the DNS server IP address fields if the ZyWALL has a fixed WAN IP address.</p> <p>Select Public DNS Server if you have the IP address of a DNS server. The IP address must be public or a private address on your local LAN. Enter the DNS server's IP address in the field to the right.</p> <p>Public DNS Server entries with the IP address set to 0.0.0.0 are not allowed.</p> <p>Select Private DNS Server if the DNS server has a private IP address and is located behind a VPN peer. Enter the DNS server's IP address in the field to the right.</p> <p>With a private DNS server, you must also configure the first DNS server entry for the LAN, DMZ and/or WLAN in the DNS DHCP screen to use DNS Relay.</p> <p>You must also configure a VPN rule since the ZyWALL uses a VPN tunnel when it relays DNS queries to the private DNS server. The rule must include the LAN IP address of the ZyWALL as a local IP address and the IP address of the DNS server as a remote IP address.</p> <p>Private DNS Server entries with the IP address set to 0.0.0.0 are not allowed.</p>
Apply	Click Apply to save your changes back to the ZyWALL.
Cancel	Click Cancel to exit this screen without saving.

20.7 DNS Cache

DNS cache is the temporary storage area where a router stores responses from DNS servers. When the ZyWALL receives a positive or negative response for a DNS query, it records the response in the DNS cache. A positive response means that the ZyWALL received the IP address for a domain name that it checked with a DNS server within the five second DNS timeout period. A negative response means that the ZyWALL did not receive a response for a query it sent to a DNS server within the five second DNS timeout period.

When the ZyWALL receives DNS queries, it compares them against the DNS cache before querying a DNS server. If the DNS query matches a positive entry, the ZyWALL responds with the IP address from the entry. If the DNS query matches a negative entry, the ZyWALL replies that the DNS query failed.

20.8 Configure DNS Cache

To configure your ZyWALL's DNS caching, click **ADVANCED > DNS > Cache**. The screen appears as shown.

Figure 223 ADVANCED > DNS > Cache

#	Cache Type	Domain Name	IP Address	Remaining Time (sec)	Modify
1	Positive	gfnet.zyxel.com.tw	203.160.254.59	3437	
2	Positive	ms07.spamcatcher.net	71.129.195.161	2297	

The following table describes the labels in this screen.

LABEL	DESCRIPTION
DNS Cache Setup	
Cache Positive DNS Resolutions	Select the check box to record the positive DNS resolutions in the cache. Caching positive DNS resolutions helps speed up the ZyWALL's processing of commonly queried domain names and reduces the amount of traffic that the ZyWALL sends out to the WAN.

LABEL	DESCRIPTION
Maximum TTL	Type the maximum time to live (TTL) (60 to 3600 seconds). This sets how long the ZyWALL is to allow a positive resolution entry to remain in the DNS cache before discarding it.
Cache Negative DNS Resolutions	Caching negative DNS resolutions helps speed up the ZyWALL's processing of commonly queried domain names (for which DNS resolution has failed) and reduces the amount of traffic that the ZyWALL sends out to the WAN.
Negative Cache Period	Type the time (60 to 3600 seconds) that the ZyWALL is to allow a negative resolution entry to remain in the DNS cache before discarding it.
Apply	Click Apply to save your changes back to the ZyWALL.
Reset	Click Reset to begin configuring this screen afresh.
DNS Cache Entry	
Flush	Click this button to clear the cache manually. After you flush the cache, the ZyWALL must query the DNS servers again for any domain names that had been previously resolved.
Refresh	Click this button to reload the cache.
#	This is the index number of a record.
Cache Type	This displays whether the response for the DNS request is positive or negative.
Domain Name	This is the domain name of a host.
IP Address	This is the (resolved) IP address of a host. This field displays 0.0.0.0 for negative DNS resolution entries.
Remaining Time (sec)	This is the number of seconds left before the DNS resolution entry is discarded from the cache.
Modify	Click the delete icon to remove the DNS resolution entry from the cache.

20.9 Configuring DNS DHCP

Click **ADVANCED > DNS > DHCP** to open the **DNS DHCP** screen shown next. Use this screen to configure the DNS server information that the ZyWALL sends to its LAN, DMZ or WLAN DHCP clients.

Figure 224 ADVANCED > DNS > DHCP

DNS

System Cache **DHCP** DDNS

DNS Servers Assigned by DHCP Server

Selected Interface LAN

#	DNS	IP
1	First DNS Server	From ISP WAN 1st DNS: 172.23.5.1
2	Second DNS Server	From ISP WAN 2nd DNS: 172.23.5.2
3	Third DNS Server	None 0 . 0 . 0 . 0

Apply Reset

The following table describes the labels in this screen.

LABEL	DESCRIPTION
DNS Servers Assigned by DHCP Server	The ZyWALL passes a DNS (Domain Name System) server IP address to the DHCP clients.
Selected Interface	Select an interface from the drop-down list box to configure the DNS servers for the specified interface.
DNS	These read-only labels represent the DNS servers.
IP	<p>Select From ISP if your ISP dynamically assigns DNS server information (and the ZyWALL's WAN IP address). Use the drop-down list box to select a DNS server IP address that the ISP assigns in the field to the right.</p> <p>Select User-Defined if you have the IP address of a DNS server. Enter the DNS server's IP address in the field to the right. If you chose User-Defined, but leave the IP address set to 0.0.0.0, User-Defined changes to None after you click Apply. If you set a second choice to User-Defined, and enter the same IP address, the second User-Defined changes to None after you click Apply.</p> <p>Select DNS Relay to have the ZyWALL act as a DNS proxy. The ZyWALL's LAN, DMZ or WLAN IP address displays in the field to the right (read-only). The ZyWALL tells the DHCP clients on the LAN, DMZ or WLAN that the ZyWALL itself is the DNS server. When a computer on the LAN, DMZ or WLAN sends a DNS query to the ZyWALL, the ZyWALL forwards the query to the ZyWALL's system DNS server (configured in the DNS System screen) and relays the response back to the computer. You can only select DNS Relay for one of the three servers; if you select DNS Relay for a second or third DNS server, that choice changes to None after you click Apply.</p> <p>Select None if you do not want to configure DNS servers. You must have another DHCP sever on your LAN, or else the computers must have their DNS server addresses manually configured. If you do not configure a DNS server, you must know the IP address of a computer in order to access it.</p>
Apply	Click Apply to save your changes back to the ZyWALL.
Reset	Click Reset to begin configuring this screen afresh.

20.10 Dynamic DNS

Dynamic DNS allows you to update your current dynamic IP address with one or many dynamic DNS services so that anyone can contact you (in NetMeeting, CU-SeeMe, etc.). You can also access your FTP server or Web site on your own computer using a domain name (for instance myhost.dhs.org, where myhost is a name of your choice) that will never change instead of using an IP address that changes each time you reconnect. Your friends or relatives will always be able to call you even if they don't know your IP address.

First of all, you need to have registered a dynamic DNS account with www.dyndns.org. This is for people with a dynamic IP from their ISP or DHCP server that would still like to have a domain name. The Dynamic DNS service provider will give you a password or key.



You must go to the Dynamic DNS service provider's website and register a user account and a domain name before you can use the Dynamic DNS service with your ZyWALL.

20.10.1 DYNDNS Wildcard

Enabling the wildcard feature for your host causes *.yourhost.dyndns.org to be aliased to the same IP address as yourhost.dyndns.org. This feature is useful if you want to be able to use, for example, www.yourhost.dyndns.org and still reach your hostname.



If you have a private WAN IP address, then you cannot use Dynamic DNS.

20.11 Configuring Dynamic DNS

To change your ZyWALL's DDNS, click **ADVANCED > DNS > DDNS**. The screen appears as shown.

Figure 225 ADVANCED > DNS > DDNS

#	Domain Name	DDNS Type	Offline	Wildcard	IP Address Update Policy
1	ZyWALL-1	Dynamic	<input type="checkbox"/>	<input checked="" type="checkbox"/>	Use WAN IP Address
2		Dynamic	<input type="checkbox"/>	<input checked="" type="checkbox"/>	Let DDNS Server Auto Detect
3		Custom	<input type="checkbox"/>	<input type="checkbox"/>	Use User-Defined 0 . 0 . 0 . 0
4		Static	<input type="checkbox"/>	<input type="checkbox"/>	Use WAN IP Address
5		Dynamic	<input type="checkbox"/>	<input type="checkbox"/>	Use WAN IP Address

The following table describes the labels in this screen.

LABEL	DESCRIPTION
Account Setup	
Active	Select this check box to use dynamic DNS.
Service Provider	This is the name of your Dynamic DNS service provider.
Username	Enter your user name. You can use up to 31 alphanumeric characters (and the underscore). Spaces are not allowed.
Password	Enter the password associated with the user name above. You can use up to 31 alphanumeric characters (and the underscore). Spaces are not allowed.
My Domain Names	
Domain Name 1~5	Enter the host names in these fields.

LABEL	DESCRIPTION
DDNS Type	<p>Select the type of service that you are registered for from your Dynamic DNS service provider.</p> <p>Select Dynamic if you have the Dynamic DNS service.</p> <p>Select Static if you have the Static DNS service.</p> <p>Select Custom if you have the Custom DNS service.</p>
Offline	<p>This option is available when Custom is selected in the DDNS Type field.</p> <p>Check with your Dynamic DNS service provider to have traffic redirected to a URL (that you can specify) while you are off line.</p>
Wildcard	<p>Select the check box to enable DYNDNS Wildcard.</p>
IP Address Update Policy	<p>Select Use WAN IP Address to have the ZyWALL update the domain name with the WAN port's IP address.</p> <p>Select Use User-Defined and enter the IP address if you have a static IP address.</p> <p>Select Let DDNS Server Auto Detect only when there are one or more NAT routers between the ZyWALL and the DDNS server. This feature has the DDNS server automatically detect and use the IP address of the NAT router that has a public IP address.</p> <p>Note: The DDNS server may not be able to detect the proper IP address if there is an HTTP proxy server between the ZyWALL and the DDNS server.</p>
Apply	<p>Click Apply to save your changes back to the ZyWALL.</p>
Reset	<p>Click Reset to begin configuring this screen afresh.</p>

Remote Management

This chapter provides information on the Remote Management screens.

21.1 Remote Management Overview

Remote management allows you to determine which services/protocols can access which ZyWALL interface (if any) from which computers.

The following figure shows secure and insecure management of the ZyWALL coming in from the WAN. HTTPS and SSH access are secure. HTTP and Telnet access are not secure.

Figure 226 Secure and Insecure Remote Management From the WAN

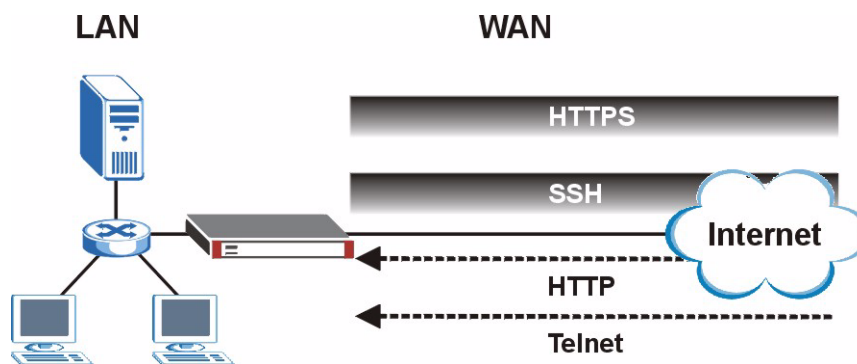

When you configure remote management to allow management from any network except the LAN, you still need to configure a firewall rule to allow access. See [Chapter 11 on page 181](#) for details on configuring firewall rules.

You can also disable a service on the ZyWALL by not allowing access for the service/protocol through any of the ZyWALL interfaces.

You may only have one remote management session running at a time. The ZyWALL automatically disconnects a remote management session of lower priority when another remote management session of higher priority starts. The priorities for the different types of remote management sessions are as follows.

- 1 Console port
- 2 SSH

- 3 Telnet
- 4 HTTPS and HTTP

21.1.1 Remote Management Limitations

Remote management does not work when:

- 1 You have not enabled that service on the interface in the corresponding remote management screen.
- 2 You have disabled that service in one of the remote management screens.
- 3 The IP address in the **Secure Client IP Address** field does not match the client IP address. If it does not match, the ZyWALL will disconnect the session immediately.
- 4 There is already another remote management session with an equal or higher priority running. You may only have one remote management session running at one time.
- 5 There is a firewall rule that blocks it.
- 6 A filter is applied (through the SMT or the commands) to block a Telnet, FTP or Web service.

21.1.2 System Timeout

There is a default system management idle timeout of five minutes (three hundred seconds). The ZyWALL automatically logs you out if the management session remains idle for longer than this timeout period. The management session does not time out when a statistics screen is polling. You can change the timeout period in the **MAINTENANCE > General** screen.

21.2 WWW (HTTP and HTTPS)

You can set the ZyWALL to use HTTP or HTTPS (HTTPS adds security) for web configurator sessions. Specify which interfaces allow web configurator access and from which IP address the access can come.

HTTPS (HyperText Transfer Protocol over Secure Socket Layer, or HTTP over SSL) is a web protocol that encrypts and decrypts web pages. Secure Socket Layer (SSL) is an application-level protocol that enables secure transactions of data by ensuring confidentiality (an unauthorized party cannot read the transferred data), authentication (one party can identify the other party) and data integrity (you know if data has been changed).

It relies upon certificates, public keys, and private keys (see [Chapter 15 on page 273](#) for more information).

HTTPS on the ZyWALL is used so that you may securely access the ZyWALL using the web configurator. The SSL protocol specifies that the SSL server (the ZyWALL) must always authenticate itself to the SSL client (the computer which requests the HTTPS connection with the ZyWALL), whereas the SSL client only should authenticate itself when the SSL server requires it to do so (select **Authenticate Client Certificates** in the **REMOTE MGMT > WWW** screen). **Authenticate Client Certificates** is optional and if selected means the SSL-client must send the ZyWALL a certificate. You must apply for a certificate for the browser from a CA that is a trusted CA on the ZyWALL.

Please refer to the following figure.

- 1 HTTPS connection requests from an SSL-aware web browser go to port 443 (by default) on the ZyWALL's WS (web server).
- 2 HTTP connection requests from a web browser go to port 80 (by default) on the ZyWALL's WS (web server).

Figure 227 HTTPS Implementation

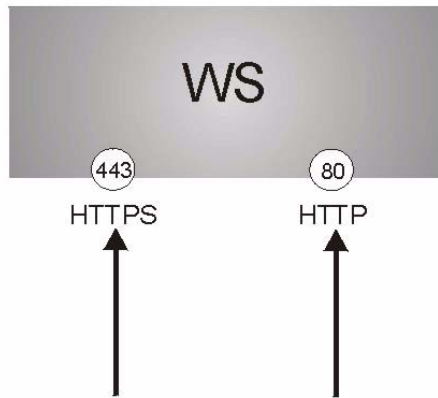

If you disable the HTTP service in the REMOTE MGMT WWW screen, then the ZyWALL blocks all HTTP connection attempts.

21.3 WWW Configuration

Click **ADVANCED > REMOTE MGMT** to open the **WWW** screen. Use this screen to configure the ZyWALL's HTTP and HTTPS management settings.

Figure 228 ADVANCED > REMOTE MGMT > WWW

The screenshot shows the 'REMOTE MANAGEMENT' interface with the 'WWW' tab selected. The 'HTTPS' section is active, showing the following settings:

- Server Certificate: auto_generated_self_signed_cert (See [My Certificates](#))
- Authenticate Client Certificates (See [Trusted CAs](#))
- Server Port: 443
- Server Access: LAN WAN DMZ WLAN
- Secure Client IP Address: All Selected (0 . 0 . 0 . 0)

The 'HTTP' section is also visible with the following settings:

- Server Port: 80
- Server Access: LAN WAN DMZ WLAN
- Secure Client IP Address: All Selected (0 . 0 . 0 . 0)

Notes at the bottom:

- Note 1: For [UPnP](#) to function normally, the HTTP service must be available for LAN computers using UPnP.
- Note 2: You may also need to create a [Firewall](#) rule.

Buttons for 'Apply' and 'Reset' are located at the bottom of the configuration area.

The following table describes the labels in this screen.

Table 110 ADVANCED > REMOTE MGMT > WWW

LABEL	DESCRIPTION
HTTPS	
Server Certificate	Select the Server Certificate that the ZyWALL will use to identify itself. The ZyWALL is the SSL server and must always authenticate itself to the SSL client (the computer which requests the HTTPS connection with the ZyWALL).
Authenticate Client Certificates	Select Authenticate Client Certificates (optional) to require the SSL client to authenticate itself to the ZyWALL by sending the ZyWALL a certificate. To do that the SSL client must have a CA-signed certificate from a CA that has been imported as a trusted CA on the ZyWALL (see Appendix F on page 619 on importing certificates for details).
Server Port	The HTTPS proxy server listens on port 443 by default. If you change the HTTPS proxy server port to a different number on the ZyWALL, for example 8443, then you must notify people who need to access the ZyWALL web configurator to use "https://ZyWALL IP Address: 8443 " as the URL.
Server Access	Select the interface(s) through which a computer may access the ZyWALL using this service. You can allow only secure web configurator access by setting the HTTP Server Access field to Disable and setting the HTTPS Server Access field to an interface(s).
Secure Client IP Address	A secure client is a "trusted" computer that is allowed to communicate with the ZyWALL using this service. Select All to allow any computer to access the ZyWALL using this service. Choose Selected to just allow the computer with the IP address that you specify to access the ZyWALL using this service.
HTTP	
Server Port	You may change the server port number for a service if needed, however you must use the same port number in order to use that service for remote management.
Server Access	Select the interface(s) through which a computer may access the ZyWALL using this service.
Secure Client IP Address	A secure client is a "trusted" computer that is allowed to communicate with the ZyWALL using this service. Select All to allow any computer to access the ZyWALL using this service. Choose Selected to just allow the computer with the IP address that you specify to access the ZyWALL using this service.
Apply	Click Apply to save your customized settings and exit this screen.
Reset	Click Reset to begin configuring this screen afresh.

21.4 HTTPS Example

If you haven't changed the default HTTPS port on the ZyWALL, then in your browser enter "https://ZyWALL IP Address/" as the web site address where "ZyWALL IP Address" is the IP address or domain name of the ZyWALL you wish to access.

21.4.1 Internet Explorer Warning Messages

When you attempt to access the ZyWALL HTTPS server, a Windows dialog box pops up asking if you trust the server certificate. Click **View Certificate** if you want to verify that the certificate is from the ZyWALL.

You see the following **Security Alert** screen in Internet Explorer. Select **Yes** to proceed to the web configurator login screen; if you select **No**, then web configurator access is blocked.

Figure 229 Security Alert Dialog Box (Internet Explorer)



21.4.2 Netscape Navigator Warning Messages

When you attempt to access the ZyWALL HTTPS server, a **Website Certified by an Unknown Authority** screen pops up asking if you trust the server certificate. Click **Examine Certificate** if you want to verify that the certificate is from the ZyWALL.

If **Accept this certificate temporarily for this session** is selected, then click **OK** to continue in Netscape.

Select **Accept this certificate permanently** to import the ZyWALL's certificate into the SSL client.

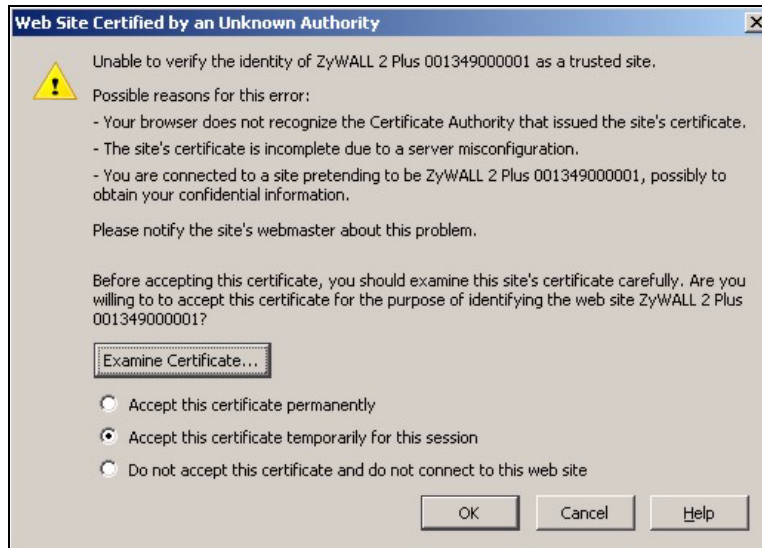
Figure 230 Security Certificate 1 (Netscape)**Figure 231** Security Certificate 2 (Netscape)

21.4.3 Avoiding the Browser Warning Messages

The following describes the main reasons that your browser displays warnings about the ZyWALL's HTTPS server certificate and what you can do to avoid seeing the warnings.

- The issuing certificate authority of the ZyWALL's HTTPS server certificate is not one of the browser's trusted certificate authorities. The issuing certificate authority of the ZyWALL's factory default certificate is the ZyWALL itself since the certificate is a self-signed certificate.
 - For the browser to trust a self-signed certificate, import the self-signed certificate into your operating system as a trusted certificate.
 - To have the browser trust the certificates issued by a certificate authority, import the certificate authority's certificate into your operating system as a trusted certificate. Refer to [Appendix F on page 619](#) for details.
- The actual IP address of the HTTPS server (the IP address of the ZyWALL's port that you are trying to access) does not match the common name specified in the ZyWALL's HTTPS server certificate that your browser received. Do the following to check the common name specified in the certificate that your ZyWALL sends to HTTPS clients.
 - 2a** Click **REMOTE MGMT**. Write down the name of the certificate displayed in the **Server Certificate** field.

- 2b** Click **CERTIFICATES**. Find the certificate and check its **Subject** column. **CN** stands for certificate's common name (see [Figure 234 on page 358](#) for an example).

Use this procedure to have the ZyWALL use a certificate with a common name that matches the ZyWALL's actual IP address. You cannot use this procedure if you need to access the WAN port and it uses a dynamically assigned IP address.

- 2a** Create a new certificate for the ZyWALL that uses the IP address (of the ZyWALL's port that you are trying to access) as the certificate's common name. For example, to use HTTPS to access a LAN port with IP address 192.168.1.1, create a certificate that uses 192.168.1.1 as the common name.
- 2b** Go to the remote management **WWW** screen and select the newly created certificate in the **Server Certificate** field. Click **Apply**.

21.4.4 Login Screen

After you accept the certificate, the ZyWALL login screen appears. The lock displayed in the bottom right of the browser status bar denotes a secure connection.

Figure 232 Example: Lock Denoting a Secure Connection

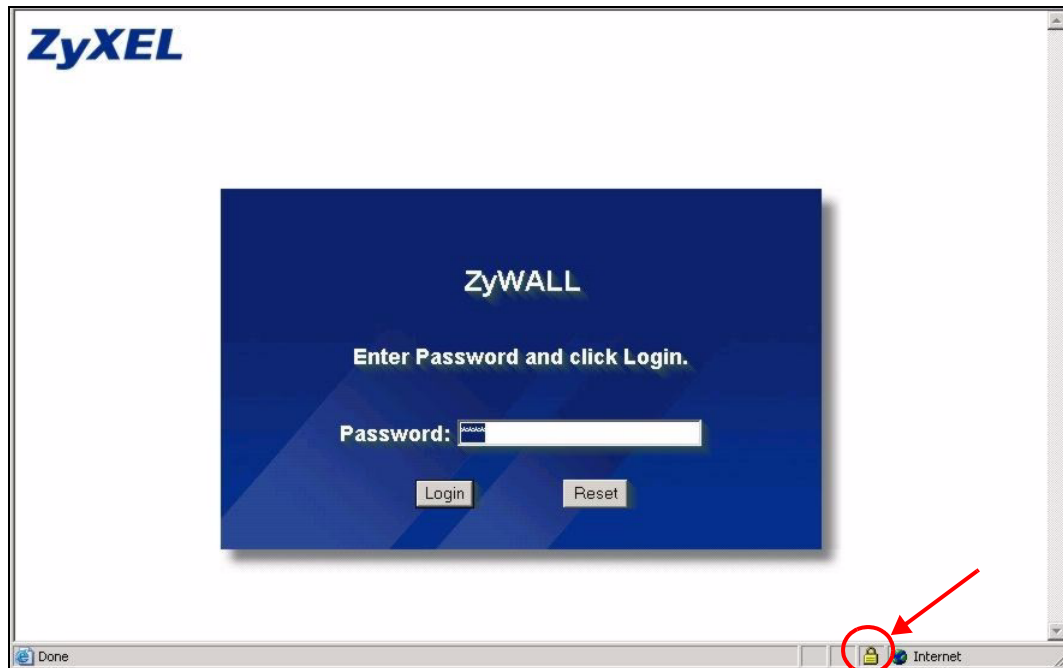

Click **Login** and you then see the next screen.

The factory default certificate is a common default certificate for all ZyWALL models.

Figure 233 Replace Certificate



Click **Apply** in the **Replace Certificate** screen to create a certificate using your ZyWALL's MAC address that will be specific to this device. Click **CERTIFICATES** to open the **My Certificates** screen. You will see information similar to that shown in the following figure.

Figure 234 Device-specific Certificate

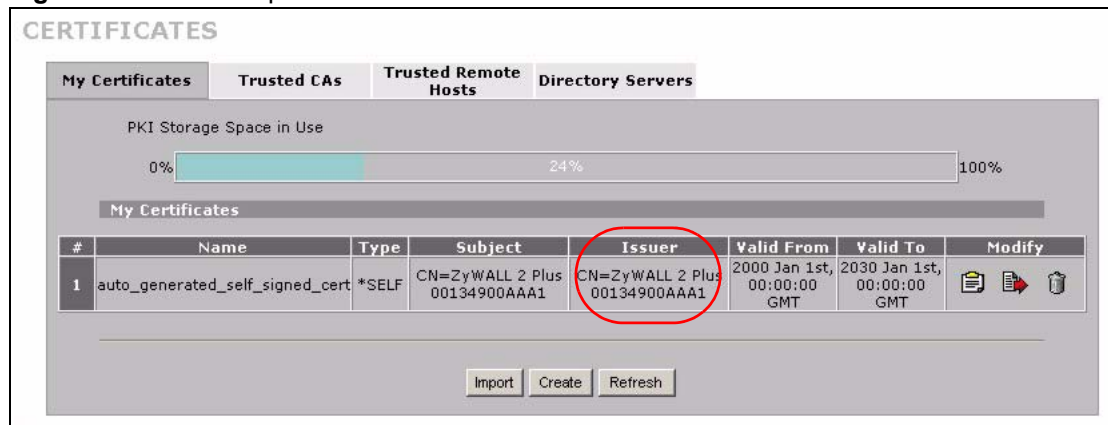

Click **Ignore** in the **Replace Certificate** screen to use the common ZyWALL certificate. You will then see this information in the **My Certificates** screen.

Figure 235 Common ZyWALL Certificate

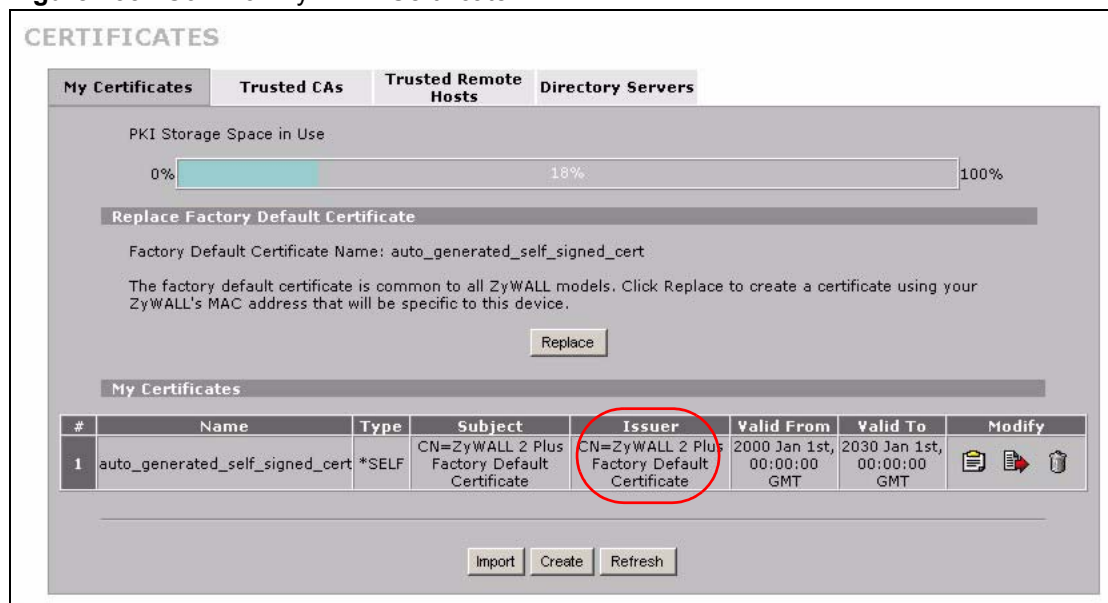

21.5 SSH

You can use SSH (Secure SHell) to securely access the ZyWALL's SMT or command line interface. Specify which interfaces allow SSH access and from which IP address the access can come.

Unlike Telnet or FTP, which transmit data in plaintext (clear or unencrypted text), SSH is a secure communication protocol that combines authentication and data encryption to provide secure encrypted communication between two hosts over an unsecured network. In the following figure, computer A on the Internet uses SSH to securely connect to the WAN port of the ZyWALL for a management session.

Figure 236 SSH Communication Over the WAN Example

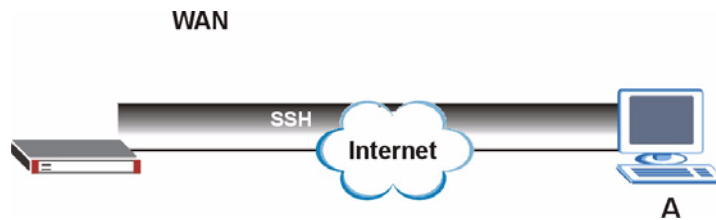

21.6 How SSH Works

The following table summarizes how a secure connection is established between two remote hosts.

Figure 237 How SSH Works

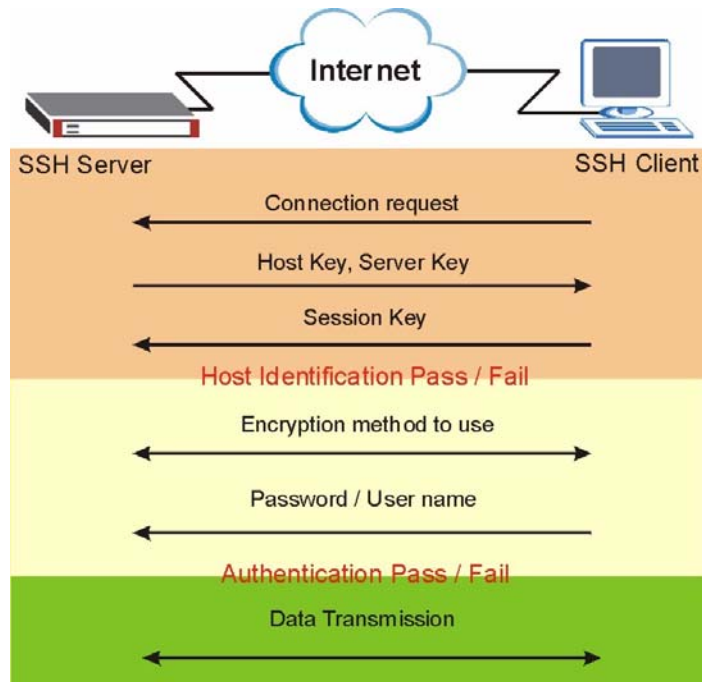

1 Host Identification

The SSH client sends a connection request to the SSH server. The server identifies itself with a host key. The client encrypts a randomly generated session key with the host key and server key and sends the result back to the server.

The client automatically saves any new server public keys. In subsequent connections, the server public key is checked against the saved version on the client computer.

2 Encryption Method

Once the identification is verified, both the client and server must agree on the type of encryption method to use.

3 Authentication and Data Transmission

After the identification is verified and data encryption activated, a secure tunnel is established between the client and the server. The client then sends its authentication information (user name and password) to the server to log in to the server.

21.7 SSH Implementation on the ZyWALL

Your ZyWALL supports SSH version 1.5 using RSA authentication and three encryption methods (DES, 3DES and Blowfish). The SSH server is implemented on the ZyWALL for remote SMT management and file transfer on port 22. Only one SSH connection is allowed at a time.

21.7.1 Requirements for Using SSH

You must install an SSH client program on a client computer (Windows or Linux operating system) that is used to connect to the ZyWALL over SSH.

21.8 Configuring SSH

Click **ADVANCED > REMOTE MGMT > SSH** to change your ZyWALL's Secure Shell settings.



It is recommended that you disable Telnet and FTP when you configure SSH for secure connections.

Figure 238 ADVANCED > REMOTE MGMT > SSH

The screenshot shows the 'REMOTE MANAGEMENT' configuration page for 'SSHv1'. At the top, there are tabs for 'WWW', 'SSH', 'TELNET', 'FTP', 'SNMP', 'DNS', and 'CNM'. The 'SSH' tab is selected. Below the tabs, the 'SSHv1' configuration is shown with the following fields:

- Server Host Key:** A dropdown menu set to 'auto_generated_self_signed_cert' with a link '(See My Certificates)'. Below it is a text input field containing '22'.
- Server Port:** A text input field containing '22'.
- Server Access:** Four checkboxes for 'LAN', 'WAN', 'DMZ', and 'WLAN', all of which are checked.
- Secure Client IP Address:** Radio buttons for 'All' (selected) and 'Selected', followed by a text input field containing '0 . 0 . 0 . 0'.

At the bottom, there is a note: 'Note: You may also need to create a Firewall rule.' Below the note are two buttons: 'Apply' and 'Reset'.

The following table describes the labels in this screen.

Table 111 ADVANCED > REMOTE MGMT > SSH

LABEL	DESCRIPTION
Server Host Key	Select the certificate whose corresponding private key is to be used to identify the ZyWALL for SSH connections. You must have certificates already configured in the My Certificates screen (Click My Certificates and see Chapter 15 on page 273 for details).
Server Port	You may change the server port number for a service if needed, however you must use the same port number in order to use that service for remote management.
Server Access	Select the interface(s) through which a computer may access the ZyWALL using this service.
Secure Client IP Address	A secure client is a “trusted” computer that is allowed to communicate with the ZyWALL using this service. Select All to allow any computer to access the ZyWALL using this service. Choose Selected to just allow the computer with the IP address that you specify to access the ZyWALL using this service.
Apply	Click Apply to save your customized settings and exit this screen.
Reset	Click Reset to begin configuring this screen afresh.

21.9 Secure Telnet Using SSH Examples

This section shows two examples using a command interface and a graphical interface SSH client program to remotely access the ZyWALL. The configuration and connection steps are similar for most SSH client programs. Refer to your SSH client program user’s guide.

21.9.1 Example 1: Microsoft Windows

This section describes how to access the ZyWALL using the Secure Shell Client program.

- 1 Launch the SSH client and specify the connection information (IP address, port number or device name) for the ZyWALL.
- 2 Configure the SSH client to accept connection using SSH version 1.
- 3 A window displays prompting you to store the host key in you computer. Click **Yes** to continue.

Figure 239 SSH Example 1: Store Host Key

Enter the password to log in to the ZyWALL. The SMT main menu displays next.

21.9.2 Example 2: Linux

This section describes how to access the ZyWALL using the OpenSSH client program that comes with most Linux distributions.

- 1 Test whether the SSH service is available on the ZyWALL.

Enter `telnet 192.168.1.1 22` at a terminal prompt and press [ENTER]. The computer attempts to connect to port 22 on the ZyWALL (using the default IP address of 192.168.1.1).

A message displays indicating the SSH protocol version supported by the ZyWALL.

Figure 240 SSH Example 2: Test

```
$ telnet 192.168.1.1 22
Trying 192.168.1.1...
Connected to 192.168.1.1.
Escape character is '^]'.
SSH-1.5-1.0.0
```

- 2 Enter `ssh -1 192.168.1.1`. This command forces your computer to connect to the ZyWALL using SSH version 1. If this is the first time you are connecting to the ZyWALL using SSH, a message displays prompting you to save the host information of the ZyWALL. Type `yes` and press [ENTER].

Then enter the password to log in to the ZyWALL.

Figure 241 SSH Example 2: Log in

```

$ ssh -1 192.168.1.1
The authenticity of host '192.168.1.1 (192.168.1.1)' can't be
established.
RSA1 key fingerprint is
21:6c:07:25:7e:f4:75:80:ec:af:bd:d4:3d:80:53:d1.
Are you sure you want to continue connecting (yes/no)? yes
Warning: Permanently added '192.168.1.1' (RSA1) to the list of
known hosts.
Administrator@192.168.1.1's password:

```

- 3 The SMT main menu displays next.

21.10 Secure FTP Using SSH Example

This section shows an example on file transfer using the OpenSSH client program. The configuration and connection steps are similar for other SSH client programs. Refer to your SSH client program user's guide.

- 1 Enter “`sftp -1 192.168.1.1`”. This command forces your computer to connect to the ZyWALL for secure file transfer using SSH version 1. If this is the first time you are connecting to the ZyWALL using SSH, a message displays prompting you to save the host information of the ZyWALL. Type “yes” and press [ENTER].
- 2 Enter the password to login to the ZyWALL.
- 3 Use the “`put`” command to upload a new firmware to the ZyWALL.

Figure 242 Secure FTP: Firmware Upload Example

```

$ sftp -1 192.168.1.1
Connecting to 192.168.1.1...
The authenticity of host '192.168.1.1 (192.168.1.1)' can't be
established.
RSA1 key fingerprint is
21:6c:07:25:7e:f4:75:80:ec:af:bd:d4:3d:80:53:d1.
Are you sure you want to continue connecting (yes/no)? yes
Warning: Permanently added '192.168.1.1' (RSA1) to the list of
known hosts.
Administrator@192.168.1.1's password:
sftp> put firmware.bin ras
Uploading firmware.bin to /ras
Read from remote host 192.168.1.1: Connection reset by peer
Connection closed
$

```

21.11 Telnet

You can use Telnet to access the ZyWALL's SMT or command line interface. Specify which interfaces allow Telnet access and from which IP address the access can come.

21.12 Configuring TELNET

Click **ADVANCED > REMOTE MGMT > TELNET** to open the following screen. Use this screen to specify which interfaces allow Telnet access and from which IP address the access can come.



It is recommended that you disable Telnet and FTP when you configure SSH for secure connections.

Figure 243 ADVANCED > REMOTE MGMT > TELNET

The following table describes the labels in this screen.

Table 112 ADVANCED > REMOTE MGMT > TELNET

LABEL	DESCRIPTION
Server Port	You may change the server port number for a service if needed, however you must use the same port number in order to use that service for remote management.
Server Access	Select the interface(s) through which a computer may access the ZyWALL using this service.
Secure Client IP Address	A secure client is a "trusted" computer that is allowed to communicate with the ZyWALL using this service. Select All to allow any computer to access the ZyWALL using this service. Choose Selected to just allow the computer with the IP address that you specify to access the ZyWALL using this service.
Apply	Click Apply to save your customized settings and exit this screen.
Reset	Click Reset to begin configuring this screen afresh.

21.13 FTP

You can use FTP (File Transfer Protocol) to upload and download the ZyWALL's firmware and configuration files, please see the chapter on firmware and configuration file maintenance for details. To use this feature, your computer must have an FTP client.

To change your ZyWALL's FTP settings, click **ADVANCED > REMOTE MGMT > FTP**. The screen appears as shown. Use this screen to specify which interfaces allow FTP access and from which IP address the access can come.



It is recommended that you disable Telnet and FTP when you configure SSH for secure connections.

Figure 244 ADVANCED > REMOTE MGMT > FTP

The following table describes the labels in this screen.

Table 113 ADVANCED > REMOTE MGMT > FTP

LABEL	DESCRIPTION
Server Port	You may change the server port number for a service if needed, however you must use the same port number in order to use that service for remote management.
Server Access	Select the interface(s) through which a computer may access the ZyWALL using this service.
Secure Client IP Address	A secure client is a "trusted" computer that is allowed to communicate with the ZyWALL using this service. Select All to allow any computer to access the ZyWALL using this service. Choose Selected to just allow the computer with the IP address that you specify to access the ZyWALL using this service.
Apply	Click Apply to save your customized settings.
Reset	Click Reset to begin configuring this screen afresh.

21.14 SNMP

Simple Network Management Protocol is a protocol used for exchanging management information between network devices. SNMP is a member of the TCP/IP protocol suite. Your ZyWALL supports SNMP agent functionality, which allows a manager station to manage and monitor the ZyWALL through the network. The ZyWALL supports SNMP version one (SNMPv1). The next figure illustrates an SNMP management operation. SNMP is only available if TCP/IP is configured.



SNMP is only available if TCP/IP is configured.

Figure 245 SNMP Management Model

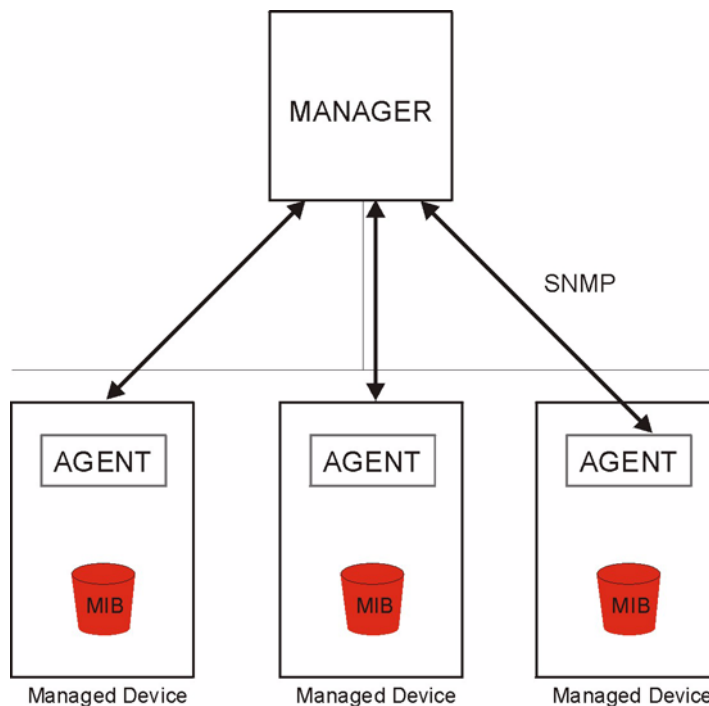

An SNMP managed network consists of two main types of component: agents and a manager.

An agent is a management software module that resides in a managed device (the ZyWALL). An agent translates the local management information from the managed device into a form compatible with SNMP. The manager is the console through which network administrators perform network management functions. It executes applications that control and monitor managed devices.

The managed devices contain object variables/managed objects that define each piece of information to be collected about a device. Examples of variables include such as number of packets received, node port status etc. A Management Information Base (MIB) is a collection of managed objects. SNMP allows a manager and agents to communicate for the purpose of accessing these objects.

SNMP itself is a simple request/response protocol based on the manager/agent model. The manager issues a request and the agent returns responses using the following protocol operations:

- Get - Allows the manager to retrieve an object variable from the agent.
- GetNext - Allows the manager to retrieve the next object variable from a table or list within an agent. In SNMPv1, when a manager wants to retrieve all elements of a table from an agent, it initiates a Get operation, followed by a series of GetNext operations.
- Set - Allows the manager to set values for object variables within an agent.
- Trap - Used by the agent to inform the manager of some events.

21.14.1 Supported MIBs

The ZyWALL supports MIB II that is defined in RFC-1213 and RFC-1215. The focus of the MIBs is to let administrators collect statistical data and monitor status and performance.

21.14.2 SNMP Traps

The ZyWALL will send traps to the SNMP manager when any one of the following events occurs:

Table 114 SNMP Traps

TRAP #	TRAP NAME	DESCRIPTION
0	coldStart (defined in <i>RFC-1215</i>)	A trap is sent after booting (power on).
1	warmStart (defined in <i>RFC-1215</i>)	A trap is sent after booting (software reboot).
4	authenticationFailure (defined in <i>RFC-1215</i>)	A trap is sent to the manager when receiving any SNMP get or set requirements with the wrong community (password).
6	whyReboot (defined in ZYXEL-MIB)	A trap is sent with the reason of restart before rebooting when the system is going to restart (warm start).
6a	For intentional reboot :	A trap is sent with the message "System reboot by user!" if reboot is done intentionally, (for example, download new files, CI command "sys reboot", etc.).
6b	For fatal error :	A trap is sent with the message of the fatal code if the system reboots because of fatal errors.

21.14.3 REMOTE MANAGEMENT: SNMP

To change your ZyWALL's SNMP settings, click **ADVANCED > REMOTE MGMT > SNMP**. The screen appears as shown.

Figure 246 ADVANCED > REMOTE MGMT > SNMP

The following table describes the labels in this screen.

Table 115 ADVANCED > REMOTE MGMT > SNMP

LABEL	DESCRIPTION
SNMP Configuration	
Get Community	Enter the Get Community , which is the password for the incoming Get and GetNext requests from the management station. The default is public and allows all requests.
Set Community	Enter the Set community , which is the password for incoming Set requests from the management station. The default is public and allows all requests.
Trap	
Community	Type the trap community, which is the password sent with each trap to the SNMP manager. The default is public and allows all requests.
Destination	Type the IP address of the station to send your SNMP traps to.
SNMP	
Service Port	You may change the server port number for a service if needed, however you must use the same port number in order to use that service for remote management.
Service Access	Select the interface(s) through which a computer may access the ZyWALL using this service.
Secure Client IP Address	A secure client is a “trusted” computer that is allowed to communicate with the ZyWALL using this service. Select All to allow any computer to access the ZyWALL using this service. Choose Selected to just allow the computer with the IP address that you specify to access the ZyWALL using this service.
Apply	Click Apply to save your customized settings.
Reset	Click Reset to begin configuring this screen afresh.

21.15 DNS

DNS (Domain Name System) maps a domain name to its corresponding IP address and vice versa. Refer to [Chapter 8 on page 141](#) for more information.

Click **ADVANCED > REMOTE MGMT > DNS** to change your ZyWALL's DNS settings. Use this screen to set from which IP address the ZyWALL will accept DNS queries and on which interface it can send them your ZyWALL's DNS settings. This feature is not available when the ZyWALL is set to bridge mode.

Figure 247 ADVANCED > REMOTE MGMT > DNS

The screenshot shows the 'REMOTE MANAGEMENT' interface with the 'DNS' tab selected. The configuration options are as follows:

- Service Port:** 53
- Service Access:** LAN, WAN, DMZ, WLAN (all checked)
- Secure Client IP Address:** All (selected), Selected (radio button), IP address field: 0 . 0 . 0 . 0

Buttons for 'Apply' and 'Reset' are visible at the bottom.

The following table describes the labels in this screen.

Table 116 ADVANCED > REMOTE MGMT > DNS

LABEL	DESCRIPTION
Server Port	The DNS service port number is 53 and cannot be changed here.
Service Access	Select the interface(s) through which a computer may send DNS queries to the ZyWALL.
Secure Client IP Address	A secure client is a "trusted" computer that is allowed to send DNS queries to the ZyWALL. Select All to allow any computer to send DNS queries to the ZyWALL. Choose Selected to just allow the computer with the IP address that you specify to send DNS queries to the ZyWALL.
Apply	Click Apply to save your customized settings.
Reset	Click Reset to begin configuring this screen afresh.

21.16 Introducing Vantage CNM

Vantage CNM (Centralized Network Management) is a browser-based global management solution that allows an administrator from any location to easily configure, manage, monitor and troubleshoot ZyXEL devices located worldwide. See the Vantage CNM User's Guide for details.

If you allow your ZyWALL to be managed by the Vantage CNM server, then you should not configure the ZyWALL (using either the web configurator, SMT menus or commands) without notifying the Vantage CNM administrator.

21.17 Configuring CNM

Vantage CNM is disabled on the device by default. Click **ADVANCED > REMOTE MGMT > CNM** to configure your device's Vantage CNM settings.

Figure 248 ADVANCED > REMOTE MGMT > CNM

The following table describes the labels in this screen.

Table 117 ADVANCED > REMOTE MGMT > CNM

LABEL	DESCRIPTION
Registration Information	
Registration Status	This read only field displays Not Registered when Enable is not selected. It displays Registering when the ZyWALL first connects with the Vantage CNM server and then Registered after it has been successfully registered with the Vantage CNM server. It will continue to display Registering until it successfully registers with the Vantage CNM server. It will not be able to register with the Vantage CNM server if: The Vantage CNM server is down. The Vantage CNM server IP address is incorrect. The Vantage CNM server is behind a NAT router or firewall that does not forward packets through to the Vantage CNM server. The encryption algorithms and/or encryption keys do not match between the ZyWALL and the Vantage CNM server.
Last Registration Time	This field displays the last date (year-month-date) and time (hours-minutes-seconds) that the ZyWALL registered with the Vantage CNM server. It displays all zeroes if it has not yet registered with the Vantage CNM server.
Refresh	Click Refresh to update the registration status and last registration time.
Vantage CNM Setup	
Enable	Select this check box to allow Vantage CNM to manage your ZyWALL.

Table 117 ADVANCED > REMOTE MGMT > CNM (continued)

LABEL	DESCRIPTION
Vantage CNM Server Address	<p>If the Vantage server is on the same subnet as the ZyXEL device, enter the private or public IP address of the Vantage server.</p> <p>If the Vantage CNM server is on a different subnet to the ZyWALL, enter the public IP address of the Vantage server.</p> <p>If the Vantage CNM server is on a different subnet to the ZyWALL and is behind a NAT router, enter the WAN IP address of the NAT router here and configure the NAT router to forward UDP port 1864 traffic to the Vantage CNM server.</p> <p>If the Vantage CNM server is behind a firewall, you may have to create a rule on the firewall to allow UDP port 1864 traffic through to the Vantage CNM server (most (new) ZyXEL firewalls automatically allow this).</p>
Encryption Algorithm	The Encryption Algorithm field is used to encrypt communications between the ZyWALL and the Vantage CNM server. Choose from None (no encryption), DES or 3DES . The Encryption Key field appears when you select DES or 3DES . The ZyWALL must use the same encryption algorithm as the Vantage CNM server.
Encryption Key	Type eight alphanumeric characters ("0" to "9", "a" to "z" or "A" to "Z") when you choose the DES encryption algorithm and 24 alphanumeric characters ("0" to "9", "a" to "z" or "A" to "Z") when you choose the 3DES encryption algorithm. The ZyWALL must use the same encryption key as the Vantage CNM server.
Apply	Click Apply to save your changes back to the ZyWALL.
Reset	Click Reset to begin configuring this screen afresh.

This chapter introduces the Universal Plug and Play feature. This chapter is only applicable when the ZyWALL is in router mode.

22.1 Universal Plug and Play Overview

Universal Plug and Play (UPnP) is a distributed, open networking standard that uses TCP/IP for simple peer-to-peer network connectivity between devices. A UPnP device can dynamically join a network, obtain an IP address, convey its capabilities and learn about other devices on the network. In turn, a device can leave a network smoothly and automatically when it is no longer in use.

22.1.1 How Do I Know If I'm Using UPnP?

UPnP hardware is identified as an icon in the Network Connections folder (Windows XP). Each UPnP compatible device installed on your network will appear as a separate icon. Selecting the icon of a UPnP device will allow you to access the information and properties of that device.

22.1.2 NAT Traversal

UPnP NAT traversal automates the process of allowing an application to operate through NAT. UPnP network devices can automatically configure network addressing, announce their presence in the network to other UPnP devices and enable exchange of simple product and service descriptions. NAT traversal allows the following:

- Dynamic port mapping
- Learning public IP addresses
- Assigning lease times to mappings

Windows Messenger is an example of an application that supports NAT traversal and UPnP.

See [Chapter 17 on page 307](#) for further information about NAT.

22.1.3 Cautions with UPnP

The automated nature of NAT traversal applications in establishing their own services and opening firewall ports may present network security issues. Network information and configuration may also be obtained and modified by users in some network environments.

When a UPnP device joins a network, it announces its presence with a multicast message. For security reasons, the ZyWALL allows multicast messages on the LAN only.

All UPnP-enabled devices may communicate freely with each other without additional configuration. Disable UPnP if this is not your intention.

22.1.4 UPnP and ZyXEL

ZyXEL has achieved UPnP certification from the Universal Plug and Play Forum UPnP™ Implementers Corp. (UIC). ZyXEL's UPnP implementation supports IGD 1.0 (Internet Gateway Device).

See the following sections for examples of installing and using UPnP.

22.2 Configuring UPnP

Click **ADVANCED > UPnP** to display the **UPnP** screen.

Figure 249 ADVANCED > UPnP

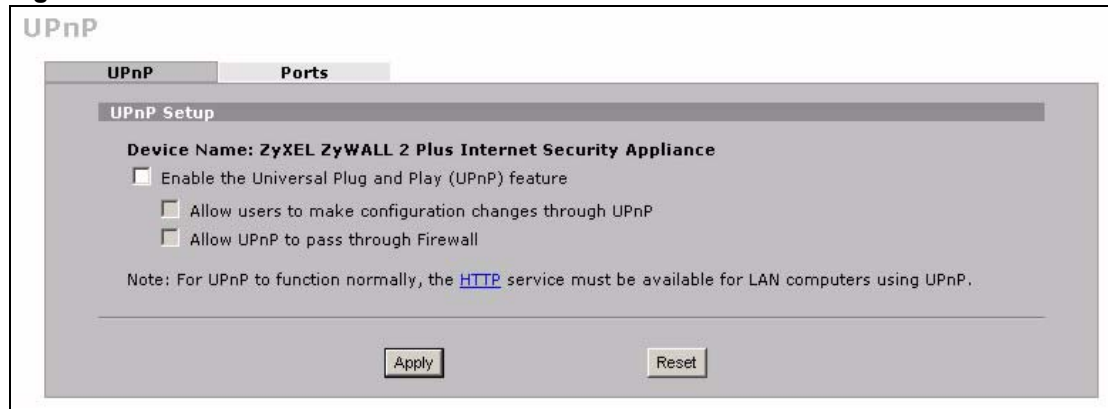

The following table describes the fields in this screen.

Table 118 ADVANCED > UPnP

LABEL	DESCRIPTION
UPnP Setup	
Device Name	This identifies the ZyXEL device in UPnP applications.
Enable the Universal Plug and Play (UPnP) feature	Select this check box to activate UPnP. Be aware that anyone could use a UPnP application to open the web configurator's login screen without entering the ZyWALL's IP address (although you must still enter the password to access the web configurator).
Allow users to make configuration changes through UPnP	Select this check box to allow UPnP-enabled applications to automatically configure the ZyWALL so that they can communicate through the ZyWALL, for example by using NAT traversal. UPnP applications automatically reserve a NAT forwarding port in order to communicate with another UPnP enabled device; this eliminates the need to manually configure port forwarding for the UPnP enabled application.
Allow UPnP to pass through Firewall	Select this check box to allow traffic from UPnP-enabled applications to bypass the firewall. Clear this check box to have the firewall block all UPnP application packets (for example, MSN packets).

Table 118 ADVANCED > UPnP

LABEL	DESCRIPTION
Apply	Click Apply to save your changes back to the ZyWALL.
Reset	Click Reset to begin configuring this screen afresh.

22.3 Displaying UPnP Port Mapping

Click **ADVANCED > UPnP > Ports** to display the **UPnP Ports** screen. Use this screen to view the NAT port mapping rules that UPnP creates on the ZyWALL.

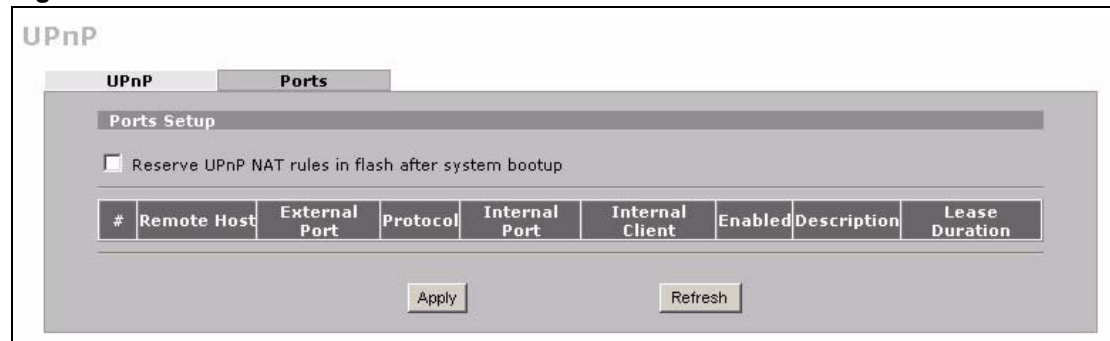
Figure 250 ADVANCED > UPnP > Ports

The following table describes the labels in this screen.

Table 119 ADVANCED > UPnP > Ports

LABEL	DESCRIPTION
Reserve UPnP NAT rules in flash after system bootup	Select this check box to have the ZyWALL retain UPnP created NAT rules even after restarting. If you use UPnP and you set a port on your computer to be fixed for a specific service (for example FTP for file transfers), this option allows the ZyWALL to keep a record when your computer uses UPnP to create a NAT forwarding rule for that service.
The following read-only table displays information about the UPnP-created NAT mapping rule entries in the ZyWALL's NAT routing table.	
#	This is the index number of the UPnP-created NAT mapping rule entry.
Remote Host	This field displays the source IP address (on the WAN) of inbound IP packets. Since this is often a wildcard, the field may be blank. When the field is blank, the ZyWALL forwards all traffic sent to the External Port on the WAN interface to the Internal Client on the Internal Port . When this field displays an external IP address, the NAT rule has the ZyWALL forward inbound packets to the Internal Client from that IP address only.
External Port	This field displays the port number that the ZyWALL "listens" on (on the WAN port) for connection requests destined for the NAT rule's Internal Port and Internal Client . The ZyWALL forwards incoming packets (from the WAN) with this port number to the Internal Client on the Internal Port (on the LAN). If the field displays "0", the ZyWALL ignores the Internal Port value and forwards requests on all external port numbers (that are otherwise unmapped) to the Internal Client .
Protocol	This field displays the protocol of the NAT mapping rule (TCP or UDP).
Internal Port	This field displays the port number on the Internal Client to which the ZyWALL should forward incoming connection requests.
Internal Client	This field displays the DNS host name or IP address of a client on the LAN. Multiple NAT clients can use a single port simultaneously if the internal client field is set to 255.255.255.255 for UDP mappings.

Table 119 ADVANCED > UPnP > Ports (continued)

LABEL	DESCRIPTION
Enabled	This field displays whether or not this UPnP-created NAT mapping rule is turned on. The UPnP-enabled device that connected to the ZyWALL and configured the UPnP-created NAT mapping rule on the ZyWALL determines whether or not the rule is enabled.
Description	This field displays a text explanation of the NAT mapping rule.
Lease Duration	This field displays a dynamic port-mapping rule's time to live (in seconds). It displays "0" if the port mapping is static.
Apply	Click Apply to save your changes back to the ZyWALL.
Refresh	Click Refresh update the screen's table.

22.4 Installing UPnP in Windows Example

This section shows how to install UPnP in Windows Me and Windows XP.

22.4.1 Installing UPnP in Windows Me

Follow the steps below to install UPnP in Windows Me.

- 1 Click **Start**, **Settings** and **Control Panel**. Double-click **Add/Remove Programs**.
- 2 Click on the **Windows Setup** tab and select **Communication** in the **Components** selection box. Click **Details**.

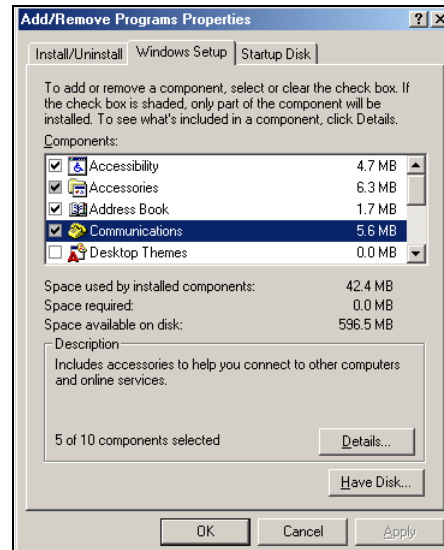

- 3 In the **Communications** window, select the **Universal Plug and Play** check box in the **Components** selection box.
- 4 Click **OK** to go back to the **Add/Remove Programs Properties** window and click **Next**.
- 5 Restart the computer when prompted.

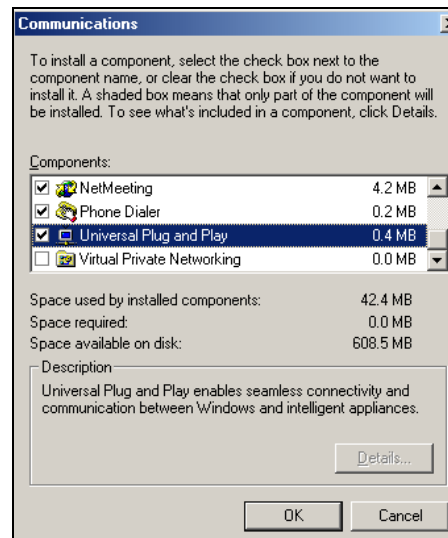

22.4.2 Installing UPnP in Windows XP

Follow the steps below to install UPnP in Windows XP.

- 1 Click **Start, Settings** and **Control Panel**.
- 2 Double-click **Network Connections**.
- 3 In the **Network Connections** window, click **Advanced** in the main menu and select **Optional Networking Components ...**.
The **Windows Optional Networking Components Wizard** window displays.
- 4 Select **Networking Service** in the **Components** selection box and click **Details**.

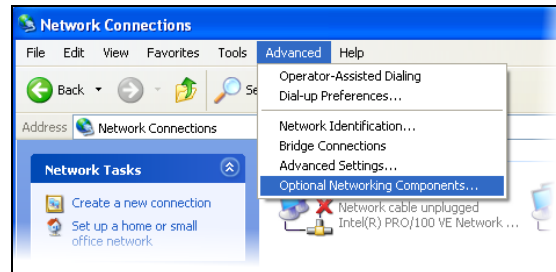

- 5 In the **Networking Services** window, select the **Universal Plug and Play** check box.
- 6 Click **OK** to go back to the **Windows Optional Networking Component Wizard** window and click **Next**.

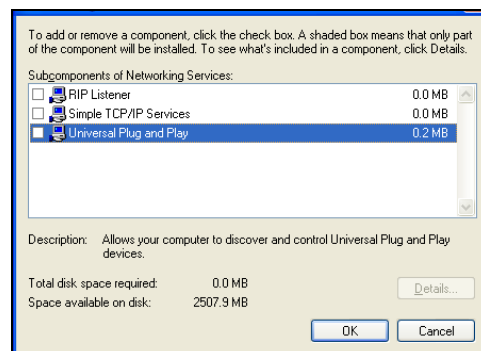
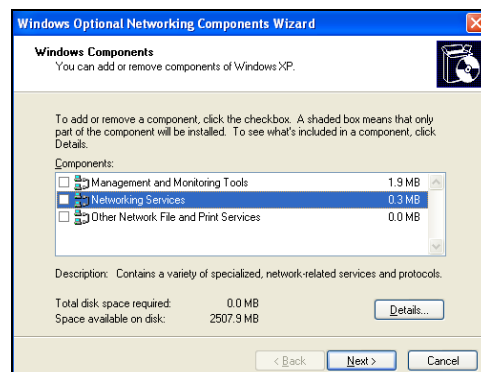

22.5 Using UPnP in Windows XP Example

This section shows you how to use the UPnP feature in Windows XP. You must already have UPnP installed in Windows XP and UPnP activated on the ZyXEL device.

Make sure the computer is connected to a LAN port of the ZyXEL device. Turn on your computer and the ZyXEL device.

22.5.1 Auto-discover Your UPnP-enabled Network Device

- 1 Click **Start** and **Control Panel**. Double-click **Network Connections**. An icon displays under **Internet Gateway**.
- 2 Right-click the icon and select **Properties**.

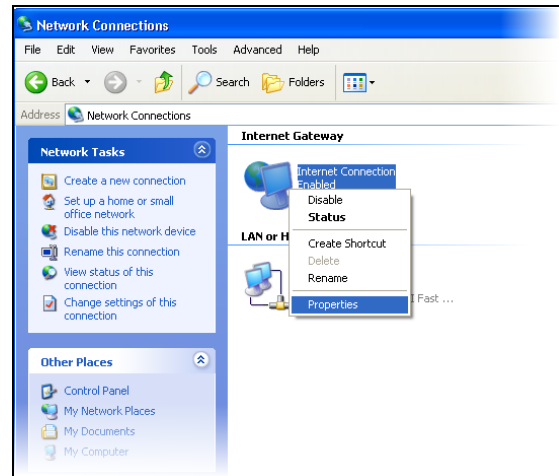

- 3 In the **Internet Connection Properties** window, click **Settings** to see the port mappings that were automatically created. You may edit or delete the port mappings or click **Add** to manually add port mappings.

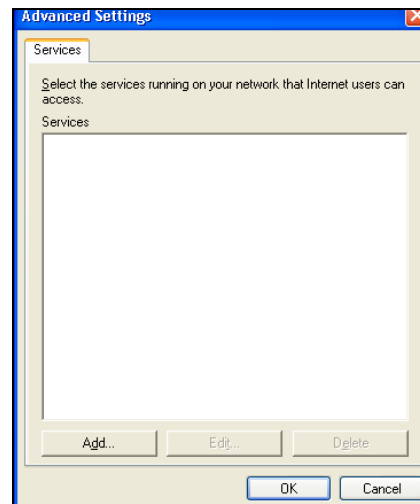
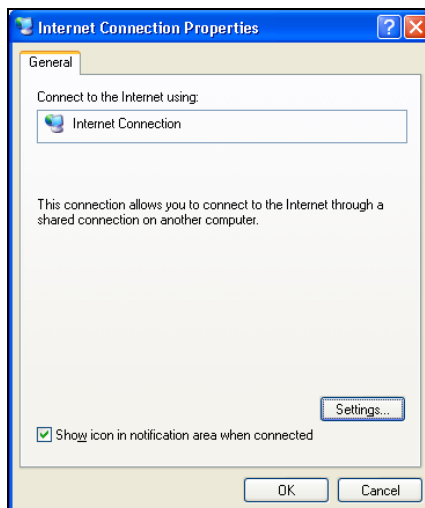

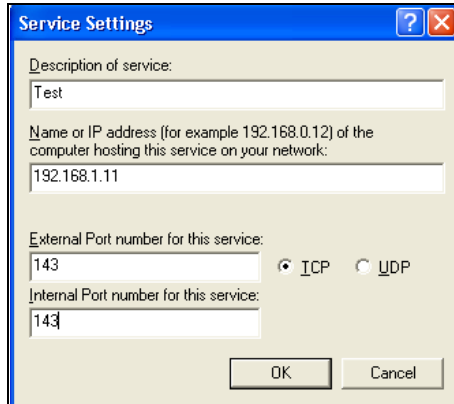

When the UPnP-enabled device is disconnected from your computer, all port mappings will be deleted automatically.

- 4 Select the **Show icon in notification area when connected** check box and click **OK**. An icon displays in the system tray.

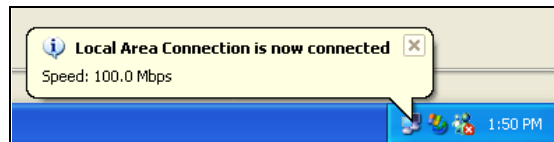

- 5 Double-click the icon to display your current Internet connection status.



22.5.2 Web Configurator Easy Access

With UPnP, you can access the web-based configurator on the ZyXEL device without finding out the IP address of the ZyXEL device first. This is helpful if you do not know the IP address of the ZyXEL device.

Follow the steps below to access the web configurator.

- 1 Click **Start** and then **Control Panel**.
- 2 Double-click **Network Connections**.
- 3 Select **My Network Places** under **Other Places**.

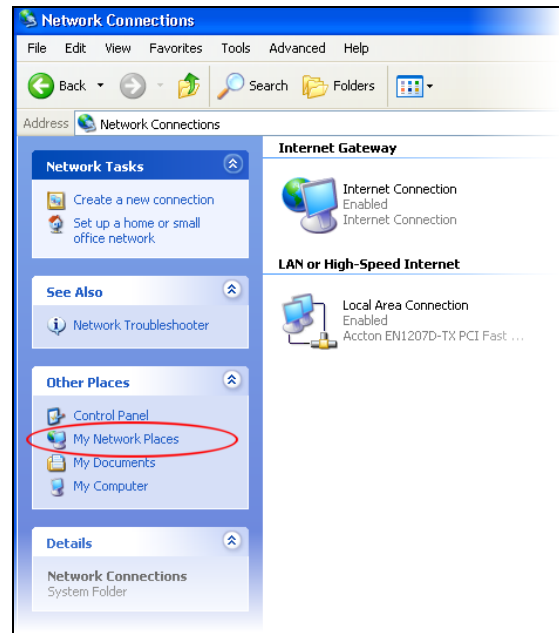

- 4 An icon with the description for each UPnP-enabled device displays under **Local Network**.
- 5 Right-click the icon for your ZyXEL device and select **Invoke**. The web configurator login screen displays.

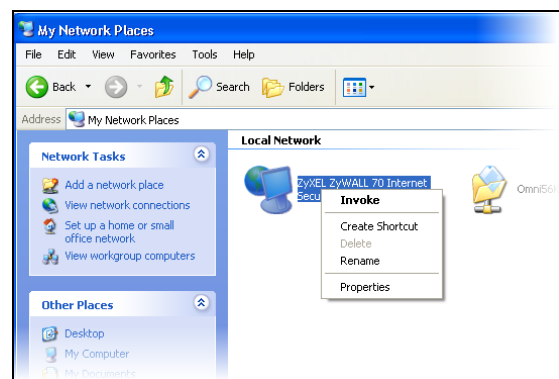

- 6 Right-click the icon for your ZyXEL device and select **Properties**. A properties window displays with basic information about the ZyXEL device.

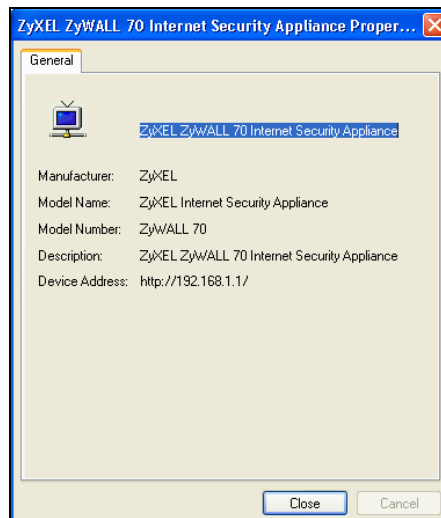

ALG Screen

This chapter covers how to use the ZyWALL's ALG feature to allow certain applications to pass through the ZyWALL.

23.1 ALG Introduction

An Application Layer Gateway (ALG) manages a specific protocol (such as SIP, H.323 or FTP) at the application layer. The ZyWALL can function as an ALG to allow certain NAT un-friendly applications (such as SIP) to operate properly through the ZyWALL.

Some applications cannot operate through NAT (are NAT un-friendly) because they embed IP addresses and port numbers in their packets' data payload. The ZyWALL examines and uses IP address and port number information embedded in the data stream. When a device behind the ZyWALL uses an application for which the ZyWALL has ALG service enabled, the ZyWALL translates the device's private IP address inside the data stream to a public IP address. It also records session port numbers and dynamically creates implicit NAT port forwarding and firewall rules for the application's traffic to come in from the WAN to the LAN.

23.1.1 ALG and NAT

The ZyWALL dynamically creates an implicit NAT session for the application's traffic from the WAN to the LAN.

The ALG on the ZyWALL supports all NAT mapping types, including **One to One**, **Many to One**, **Many to Many Overload** and **Many One to One**.

23.1.2 ALG and the Firewall

The ZyWALL uses the dynamic port that the session uses for data transfer in creating an implicit temporary firewall rule for the session's traffic. The firewall rule only allows the session's traffic to go through in the direction that the ZyWALL determines from its inspection of the data payload of the application's packets. The firewall rule is automatically deleted after the application's traffic has gone through.

23.2 FTP

File Transfer Protocol (FTP) is an Internet file transfer service that operates on the Internet and over TCP/IP networks. A system running the FTP server accepts commands from a system running an FTP client. The service allows users to send commands to the server for uploading and downloading files. The FTP ALG allows TCP packets with a port 21 destination to pass through. If the FTP server is located on the LAN, you must also configure NAT port forwarding and firewall rules if you want to allow access to the server from the WAN.

23.3 H.323

H.323 is a standard teleconferencing protocol suite that provides audio, data and video conferencing. It allows for real-time point-to-point and multipoint communication between client computers over a packet-based network that does not provide a guaranteed quality of service. NetMeeting uses H.323.

23.4 RTP

When you make a VoIP call using H.323 or SIP, the RTP (Real time Transport Protocol) is used to handle voice data transfer. See RFC 1889 for details on RTP.

23.4.1 H.323 ALG Details

- The H.323 ALG supports peer-to-peer H.323 calls.
- The H.323 ALG handles H.323 calls that go through NAT or that the ZyWALL routes. You can also make other H.323 calls that do not go through NAT or routing. Examples would be calls between LAN IP addresses that are on the same subnet.
- The H.323 ALG allows calls to go out through NAT. For example, you could make a call from a private IP address on the LAN to a peer device on the WAN.
- You must configure the firewall and port forwarding to allow incoming (peer-to-peer) calls from the WAN to a private IP address on the LAN (or DMZ or WLAN). The following example shows H.323 signaling (1) and audio (2) sessions between H.323 devices A and B.

Figure 251 H.323 ALG Example

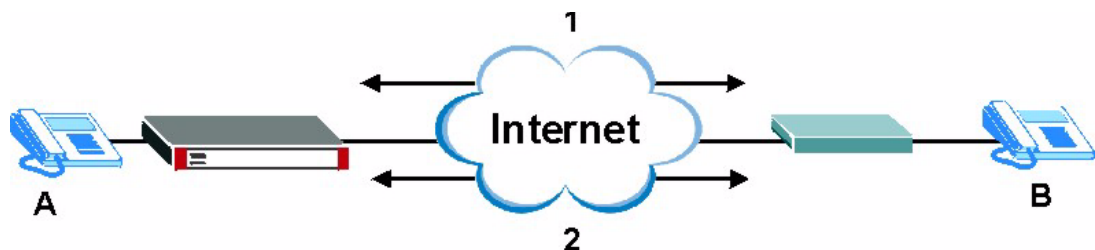

- The H.323 ALG operates on TCP packets with a port 1720 destination.
- The ZyWALL allows H.323 audio connections.

- The ZyWALL can also apply bandwidth management to traffic that goes through the H.323 ALG.

23.5 SIP

The Session Initiation Protocol (SIP) is an application-layer control (signaling) protocol that handles the setting up, altering and tearing down of voice and multimedia sessions over the Internet. SIP is used in VoIP (Voice over IP), the sending of voice signals over the Internet Protocol.

SIP signaling is separate from the media for which it handles sessions. The media that is exchanged during the session can use a different path from that of the signaling. SIP handles telephone calls and can interface with traditional circuit-switched telephone networks.

23.5.1 STUN

STUN (Simple Traversal of User Datagram Protocol (UDP) through Network Address Translators) allows the VoIP device to find the presence and types of NAT routers and/or firewalls between it and the public Internet. STUN also allows the VoIP device to find the public IP address that NAT assigned, so the VoIP device can embed it in the SIP data stream. See RFC 3489 for details on STUN. You do not need to use STUN for devices behind the ZyWALL if you enable the SIP ALG.

23.5.2 SIP ALG Details

- SIP clients can be connected to the LAN, WLAN or DMZ. A SIP server must be on the WAN.
- You can make and receive calls between the LAN and the WAN, between the WLAN and the WAN and/or between the DMZ and the WAN. You cannot make a call between the LAN and the LAN, between the LAN and the DMZ, between the LAN and the WLAN, between the DMZ and the DMZ, and so on.
- The SIP ALG allows UDP packets with a port 5060 destination to pass through.
- The ZyWALL allows SIP audio connections.

The following example shows SIP signaling (1) and audio (2) sessions between SIP clients A and B and the SIP server (S).

Figure 252 SIP ALG Example

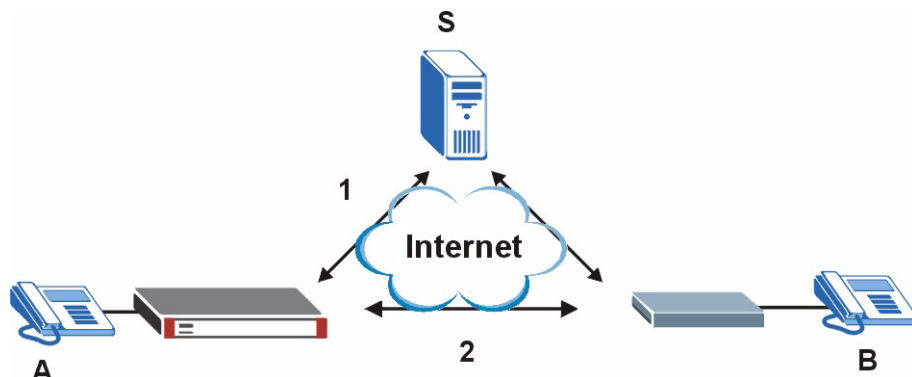

23.5.3 SIP Signaling Session Timeout

Most SIP clients have an “expire” mechanism indicating the lifetime of signaling sessions. The SIP user agent sends registration packets to the SIP server periodically and keeps the session alive in the ZyWALL.

If the SIP client does not have this mechanism and makes no calls during the ZyWALL SIP timeout default (60 minutes), the ZyWALL SIP ALG drops any incoming calls after the timeout period.

23.5.4 SIP Audio Session Timeout

If no voice packets go through the SIP ALG before the timeout period (default 5 minutes) expires, the SIP ALG does not drop the call but blocks all voice traffic and deletes the audio session. You cannot hear anything and you will need to make a new call to continue your conversation.

23.6 ALG Screen

Click **ADVANCED > ALG** to open the **ALG** screen. Use the **ALG** screen to turn individual ALGs off or on and set the SIP timeout.



If the ZyWALL provides an ALG for a service, you must enable the ALG in order to perform bandwidth management on that service’s traffic.

Figure 253 ADVANCED > ALG

The following table describes the labels in this screen.

Table 120 ADVANCED > ALG

LABEL	DESCRIPTION
Enable FTP ALG	Select this check box to allow FTP sessions to pass through the ZyWALL. FTP (File Transfer Program) is a program that enables fast transfer of files, including large files that may not be possible by e-mail.
Enable H.323 ALG	Select this check box to allow H.323 sessions to pass through the ZyWALL. H.323 is a protocol used for audio communications over networks.
Enable SIP ALG	Select this check box to allow SIP sessions to pass through the ZyWALL. SIP is a signaling protocol used in VoIP (Voice over IP), the sending of voice signals over Internet Protocol.
SIP Timeout	Most SIP clients have an “expire” mechanism indicating the lifetime of signaling sessions. The SIP user agent sends registration packets to the SIP server periodically and keeps the session alive in the ZyWALL. If the SIP client does not have this mechanism and makes no calls during the ZyWALL SIP timeout (default 60 minutes), the ZyWALL SIP ALG drops any incoming calls after the timeout period. Enter the SIP signaling session timeout value.
Apply	Click Apply to save your changes back to the ZyWALL.
Reset	Click Reset to begin configuring this screen afresh.

PART V

Logs and Maintenance

Logs Screens (391)

Maintenance (423)

Logs Screens

This chapter contains information about configuring general log settings and viewing the ZyWALL's logs. Refer to [Section 24.5 on page 402](#) for example log message explanations.

24.1 Configuring View Log

The web configurator allows you to look at all of the ZyWALL's logs in one location.

Click **LOGS** to open the **View Log** screen. Use the **View Log** screen to see the logs for the categories that you selected in the **Log Settings** screen (see [Section 24.3 on page 394](#)).

Options include logs about system maintenance, system errors, access control, allowed or blocked web sites, blocked web features (such as ActiveX controls, java and cookies), attacks (such as DoS) and IPSec.

Log entries in red indicate system error logs. The log wraps around and deletes the old entries after it fills. Click a column heading to sort the entries. A triangle indicates ascending or descending sort order.

Figure 254 LOGS > View Log

#	Time ▲	Message	Source	Destination	Note
1	2006-08-30 03:42:41	The device has not been registered yet.		203.160.254.58	myZyXEL.com
2	2006-08-30 03:42:41	Cert trusted: CN=www.myzyxel.com, OU=Member's, VeriSign Trust Network, OU=Authenticated by HiTRUST Inc., OU=Terms of use at w...			CERT MANAGER
3	2006-08-30 03:40:11	Successful HTTP login	192.168.1.33		User:admin
4	2006-08-30 03:40:06	DHCP server assigns 192.168.1.33 to tw (00:00:E8:7C:14:80).			
5	2006-08-30 03:40:04	DHCP server assigns 192.168.1.33 to tw (00:00:E8:7C:14:80).			
6	2006-08-30 03:38:15	Time set from NTP server: tick.stdtime.gov.tw, offset: +210224255 sec	220.130.158.51:123	172.23.37.114:1077	
7	2000-01-01 00:00:35	Failed to sync with NTP server: a.ntp.alphazed.net			
8	2000-01-01 00:00:14	WAN interface gets IP:172.23.37.114			WAN

The following table describes the labels in this screen.

Table 121 LOGS > View Log

LABEL	DESCRIPTION
Display	The categories that you select in the Log Settings page (see Section 24.3 on page 394) display in the drop-down list box. Select a category of logs to view; select All Logs to view logs from all of the log categories that you selected in the Log Settings page.
#	This field displays the log number.
Time	This field displays the time the log was recorded. See Section 25.4 on page 425 to configure the ZyWALL's time and date.
Message	This field states the reason for the log.
Source	This field lists the source IP address and the port number of the incoming packet.
Destination	This field lists the destination IP address and the port number of the incoming packet.
Note	This field displays additional information about the log entry.
Email Log Now	Click Email Log Now to send the log screen to the e-mail address specified in the Log Settings page (make sure that you have first filled in the E-mail Log Settings fields in Log Settings , see Section 24.3 on page 394).
Refresh	Click Refresh to renew the log screen.
Clear Log	Click Clear Log to delete all the logs.

24.2 Log Description Example

The following is an example of how a log displays in the command line interpreter and a description of the sample log. Refer to the appendices for more log message descriptions and details on using the command line interpreter to display logs.

```
# .time                source                destination
notes
message
5|06/08/2004 05:58:20 |172.21.4.187:137          |172.21.255.255:137
|ACCESS BLOCK
Firewall default policy: UDP (W to W/ZW)
```

Table 122 Log Description Example

LABEL	DESCRIPTION
#	This is log number five.
time	The log was generated on June 8, 2004 at 5:58 and 20 seconds AM.
source	The log was generated due to a NetBIOS packet sent from IP address 172.21.4.187 port 137.
destination	The NetBIOS packet was sent to the 172.21.255.255 subnet port 137. This was a NetBIOS UDP broadcast packet meant to discover devices on the network.

Table 122 Log Description Example

LABEL	DESCRIPTION
notes	The ZyWALL blocked the packet.
message	The ZyWALL blocked the packet in accordance with the firewall's default policy of blocking sessions that are initiated from the WAN. "UDP" means that this was a User Datagram Protocol packet. "W to W/ZW" indicates that the packet was traveling from the WAN to the WAN or the ZyWALL.

24.2.1 About the Certificate Not Trusted Log

myZyXEL.com and the update server use certificates signed by VeriSign to identify themselves. If the ZyWALL does not have a CA certificate signed by VeriSign as a trusted CA, the ZyWALL will not trust the certificate from myZyXEL.com and the update server. The ZyWALL will generate a log like "Due to error code(11), cert not trusted: SSL/TLS peer certif..." for every time it attempt to establish a (HTTPS) connection with myZyXEL.com and the update server. The V4.00 default configuration file includes a trusted CA certificate signed by VeriSign. If you upgraded to ZYNOS V4.00 firmware without uploading the V4.00 default configuration file, you can download a CA certificate signed by VeriSign from myZyXEL.com and import it into the ZyWALL as a trusted CA. This will stop the ZyWALL from generating this log every time it attempts to connect with myzyxel.com and the update server.

Follow the steps below to download the certificate from myZyXEL.com.

- 1 Go to <http://www.myZyXEL.com> and log in with your account.
- 2 Click **Download Center** and then **Certificate Download**.

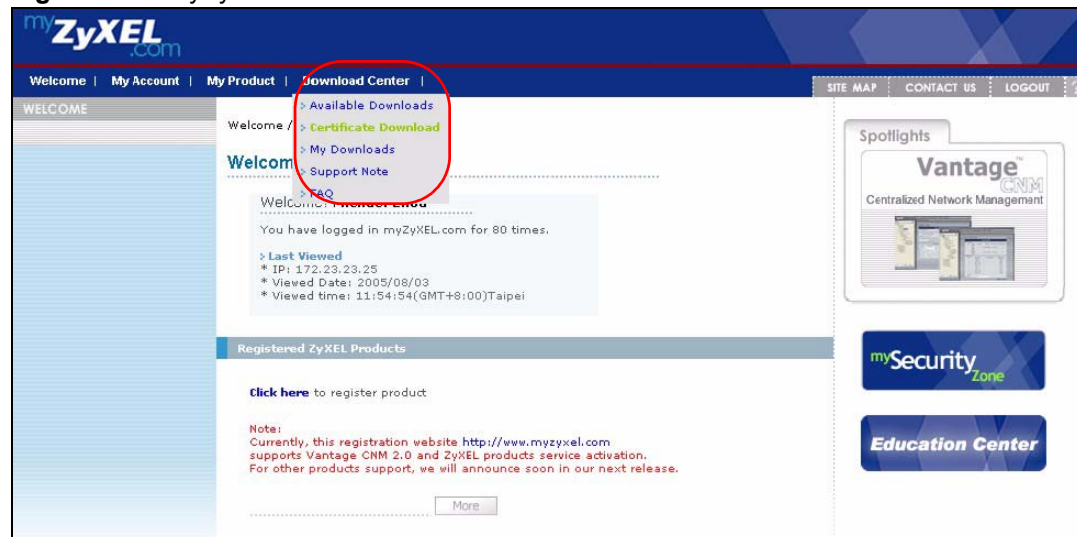
Figure 255 myZyXEL.com: Download Center

- 3 Click the link in the **Certificate Download** screen.

Figure 256 myZyXEL.com: Certificate Download

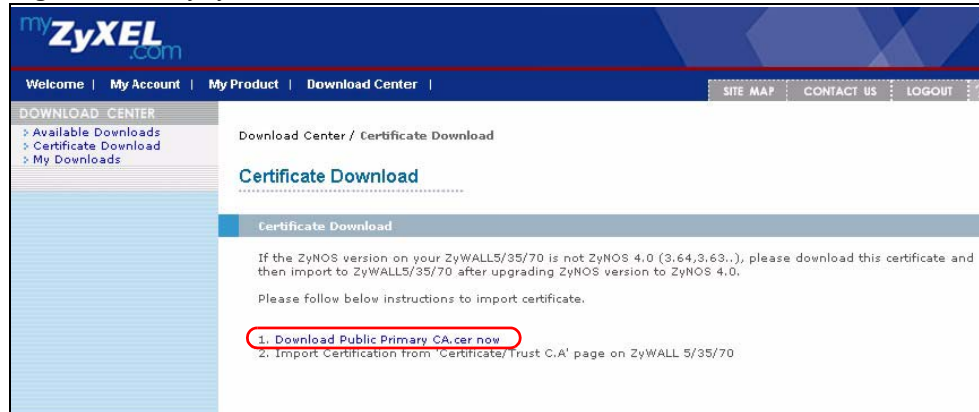

24.3 Configuring Log Settings

To change your ZyWALL's log settings, click **LOGS > Log Settings**. The screen appears as shown.

Use the **Log Settings** screen to configure to where the ZyWALL is to send logs; the schedule for when the ZyWALL is to send the logs and which logs and/or immediate alerts the ZyWALL is to send.

An alert is a type of log that warrants more serious attention. They include system errors, attacks (access control) and attempted access to blocked web sites or web sites with restricted web features such as cookies, active X and so on. Some categories such as **System Errors** consist of both logs and alerts. You may differentiate them by their color in the **View Log** screen. Alerts display in red and logs display in black.



Alerts are e-mailed as soon as they happen. Logs may be e-mailed as soon as the log is full (see Log Schedule). Selecting many alert and/or log categories (especially Access Control) may result in many e-mails being sent.

Figure 257 LOGS > Log Settings

LOGS

View Log Log Settings Reports

E-mail Log Settings

Mail Server: (Outgoing SMTP Server Name or IP Address)

Mail Subject:

Mail Sender: (E-Mail Address)

Send Log to: (E-Mail Address)

Send Alerts to: (E-Mail Address)

Log Schedule:

Day for Sending Log:

Time for Sending Log: (Hour) (Minute)

SMTP Authentication

User Name:

Password:

Syslog Logging

Active

Syslog Server: (Server Name or IP Address)

Log Facility:

Active Log and Alert

Log	Send Immediate Alert
<input checked="" type="checkbox"/> System Maintenance	<input type="checkbox"/> System Errors
<input checked="" type="checkbox"/> System Errors	<input type="checkbox"/> Access Control
<input checked="" type="checkbox"/> Access Control	<input type="checkbox"/> Blocked Web Sites
<input type="checkbox"/> Asymmetrical Routes	<input type="checkbox"/> Blocked Java etc.
<input type="checkbox"/> Multicasts / Broadcasts	<input type="checkbox"/> Attacks
<input type="checkbox"/> TCP Reset	<input type="checkbox"/> IPSec
<input type="checkbox"/> Packet Filter	<input type="checkbox"/> IKE
<input checked="" type="checkbox"/> ICMP	<input type="checkbox"/> PKI
<input checked="" type="checkbox"/> Remote Management	
<input checked="" type="checkbox"/> Call Record	
<input checked="" type="checkbox"/> PPP	
<input type="checkbox"/> UPnP	
<input type="checkbox"/> Forward Web Sites	
<input checked="" type="checkbox"/> Blocked Web Sites	
<input checked="" type="checkbox"/> Blocked Java etc.	
<input checked="" type="checkbox"/> Attacks	
<input checked="" type="checkbox"/> IPSec	
<input checked="" type="checkbox"/> IKE	
<input checked="" type="checkbox"/> PKI	
<input checked="" type="checkbox"/> SSL/TLS	

Log Consolidation

Active

Log Consolidation Period: 1 ~ 600 (Seconds)

The following table describes the labels in this screen.

Table 123 LOGS > Log Settings

LABEL	DESCRIPTION
E-mail Log Settings	
Mail Server	Enter the server name or the IP address of the mail server for the e-mail addresses specified below. If this field is left blank, logs and alert messages will not be sent via e-mail.
Mail Subject	Type a title that you want to be in the subject line of the log e-mail message that the ZyWALL sends.
Mail Sender	Enter the e-mail address that you want to be in the from/sender line of the log e-mail message that the ZyWALL sends. If you activate SMTP authentication, the e-mail address must be able to be authenticated by the mail server as well.
Send Log To	Logs are sent to the e-mail address specified in this field. If this field is left blank, logs will not be sent via e-mail.
Send Alerts To	Alerts are sent to the e-mail address specified in this field. If this field is left blank, alerts will not be sent via e-mail.
Log Schedule	<p>This drop-down menu is used to configure the frequency of log messages being sent as E-mail:</p> <p>Daily Weekly Hourly When Log is Full None.</p> <p>If you select Weekly or Daily, specify a time of day when the E-mail should be sent. If you select Weekly, then also specify which day of the week the E-mail should be sent. If you select When Log is Full, an alert is sent when the log fills up. If you select None, no log messages are sent.</p>
Day for Sending Log	Use the drop down list box to select which day of the week to send the logs.
Time for Sending Log	Enter the time of the day in 24-hour format (for example 23:00 equals 11:00 pm) to send the logs.
SMTP Authentication	<p>SMTP (Simple Mail Transfer Protocol) is the message-exchange standard for the Internet. SMTP enables you to move messages from one e-mail server to another.</p> <p>Select the check box to activate SMTP authentication. If mail server authentication is needed but this feature is disabled, you will not receive the e-mail logs.</p>
User Name	Enter the user name (up to 31 characters) (usually the user name of a mail account).
Password	Enter the password associated with the user name above.
Syslog Logging	<p>Syslog allows you to send system logs to a server.</p> <p>Syslog logging sends a log to an external syslog server.</p>
Active	Click Active to enable syslog logging.
Syslog Server	Enter the server name or IP address of the syslog server that will log the selected categories of logs.
Log Facility	Select a location from the drop down list box. The log facility allows you to log the messages to different files in the syslog server. Refer to the documentation of your syslog program for more details.
Active Log and Alert	
Log	Select the categories of logs that you want to record. Logs include alerts.

Table 123 LOGS > Log Settings (continued)

LABEL	DESCRIPTION
Send Immediate Alert	Select the categories of alerts for which you want the ZyWALL to instantly e-mail alerts to the e-mail address specified in the Send Alerts To field.
Log Consolidation	
Active	Some logs (such as the Attacks logs) may be so numerous that it becomes easy to ignore other important log messages. Select this check box to merge logs with identical messages into one log. You can use the <code>sys log consolidate msglist</code> command to see what log messages will be consolidated.
Log Consolidation Period	Specify the time interval during which the ZyWALL merges logs with identical messages into one log.
Apply	Click Apply to save your changes back to the ZyWALL.
Reset	Click Reset to begin configuring this screen afresh.

24.4 Configuring Reports

The **Reports** screen displays which computers on the LAN, DMZ or WLAN send and receive the most traffic, what kinds of traffic are used the most and which web sites are visited the most often. The ZyWALL can record and display the following network usage details:

- Web sites visited the most often
- Number of times the most visited web sites were visited
- The most-used protocols or service ports
- The amount of traffic for the most used protocols or service ports
- The LAN, DMZ or WLAN IP addresses to and/or from which the most traffic has been sent
- How much traffic has been sent to and from the LAN, DMZ or WLAN IP addresses to and/or from which the most traffic has been sent



The web site hit count may not be 100% accurate because sometimes when an individual web page loads, it may contain references to other web sites that also get counted as hits.

The ZyWALL records web site hits by counting the HTTP GET packets. Many web sites include HTTP GET references to other web sites and the ZyWALL may count these as hits, thus the web hit count is not (yet) 100% accurate.

Click **LOGS > Reports** to display the following screen.

Figure 258 LOGS > Reports



Enabling the ZyWALL's reporting function decreases the overall throughput by about 1 Mbps.

The following table describes the labels in this screen.

Table 124 LOGS > Reports

LABEL	DESCRIPTION
Collect Statistics	Select the check box and click Apply to have the ZyWALL record report data.
Send Raw Traffic Statistics to Syslog Server for Analysis	Select the check box and click Apply to have the ZyWALL send unprocessed traffic statistics to a syslog server for analysis. You must have the syslog server already configured in the Log Settings screen.
Apply	Click Apply to save your changes to the ZyWALL.
Reset	Click Reset to begin configuring this screen afresh.
Interface	Select on which interface (LAN , DMZ or WLAN) the logs will be collected. The logs on the DMZ, LAN or WLAN IP alias 1 and 2 are also recorded.
Report Type	Use the drop-down list box to select the type of reports to display. Web Site Hits displays the web sites that have been visited the most often from the LAN and how many times they have been visited. Protocol/Port displays the protocols or service ports that have been used the most and the amount of traffic for the most used protocols or service ports. Host IP Address displays the LAN, DMZ or WLAN IP addresses to and /or from which the most traffic has been sent and how much traffic has been sent to and from those IP addresses.
Refresh	Click Refresh to update the report display. The report also refreshes automatically when you close and reopen the screen.
Flush	Click Flush to discard the old report data and update the report display.



All of the recorded reports data is erased when you turn off the ZyWALL.

24.4.1 Viewing Web Site Hits

In the **Reports** screen, select **Web Site Hits** from the **Report Type** drop-down list box to have the ZyWALL record and display which web sites have been visited the most often and how many times they have been visited.

Figure 259 LOGS > Reports: Web Site Hits Example

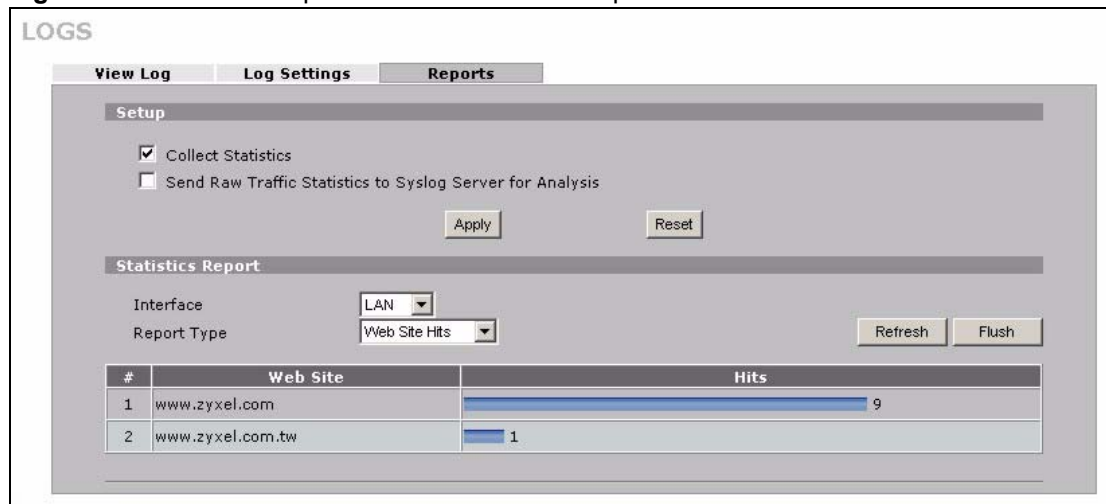

The following table describes the label in this screen.

Table 125 LOGS > Reports: Web Site Hits Report

LABEL	DESCRIPTION
Web Site	This column lists the domain names of the web sites visited most often from computers on the LAN, DMZ or WLAN. The names are ranked by the number of visits to each web site and listed in descending order with the most visited web site listed first. The ZyWALL counts each page viewed in a web site as another hit on the web site.
Hits	This column lists how many times each web site has been visited. The count starts over at 0 if a web site passes the hit count limit (see Table 128 on page 402).

24.4.2 Viewing Host IP Address

In the **Reports** screen, select **Host IP Address** from the **Report Type** drop-down list box to have the ZyWALL record and display the LAN, DMZ or WLAN IP addresses that the most traffic has been sent to and/or from and how much traffic has been sent to and/or from those IP addresses.



Computers take turns using dynamically assigned LAN, DMZ or WLAN IP addresses. The ZyWALL continues recording the bytes sent to or from a LAN, DMZ or WLAN IP address when it is assigned to a different computer.

Figure 260 LOGS > Reports: Host IP Address Example

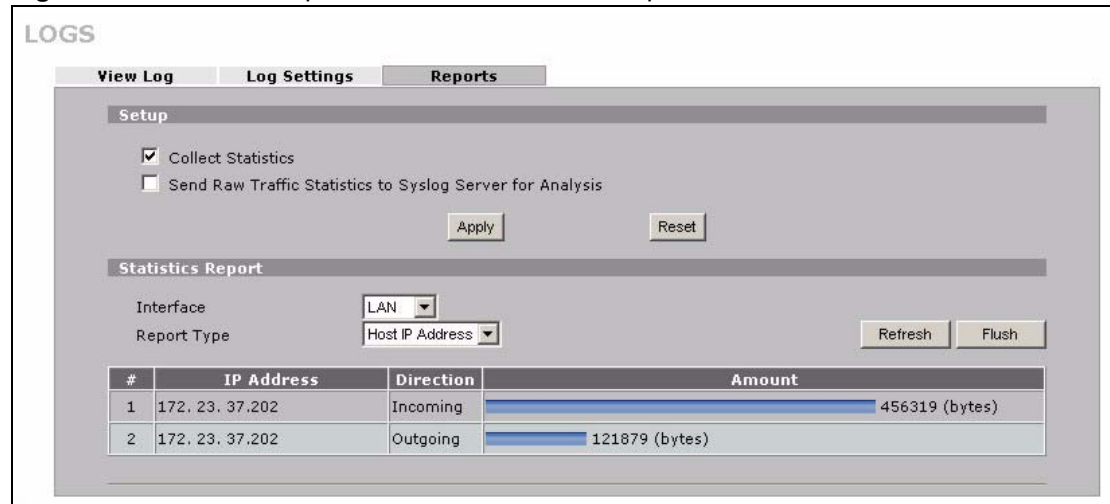

The following table describes the labels in this screen.

Table 126 LOGS > Reports: Host IP Address

LABEL	DESCRIPTION
IP Address	This column lists the LAN, DMZ or WLAN IP addresses to and/or from which the most traffic has been sent. The LAN, DMZ or WLAN IP addresses are listed in descending order with the LAN, DMZ or WLAN IP address to and/or from which the most traffic was sent listed first.
Direction	This field displays Incoming to denote traffic that is coming in from the WAN to the LAN, DMZ or WLAN. This field displays Outgoing to denote traffic that is going out from the LAN, DMZ or WLAN to the WAN.
Amount	This column displays how much traffic has gone to and from the listed LAN, DMZ or WLAN IP addresses. The measurement unit shown (bytes, Kbytes, Mbytes or Gbytes) varies with the amount of traffic sent to and from the LAN, DMZ or WLAN IP address. The count starts over at 0 if the total traffic sent to and from a LAN, DMZ or WLAN IP passes the bytes count limit (see Table 128 on page 402).

24.4.3 Viewing Protocol/Port

In the **Reports** screen, select **Protocol/Port** from the **Report Type** drop-down list box to have the ZyWALL record and display which protocols or service ports have been used the most and the amount of traffic for the most used protocols or service ports.

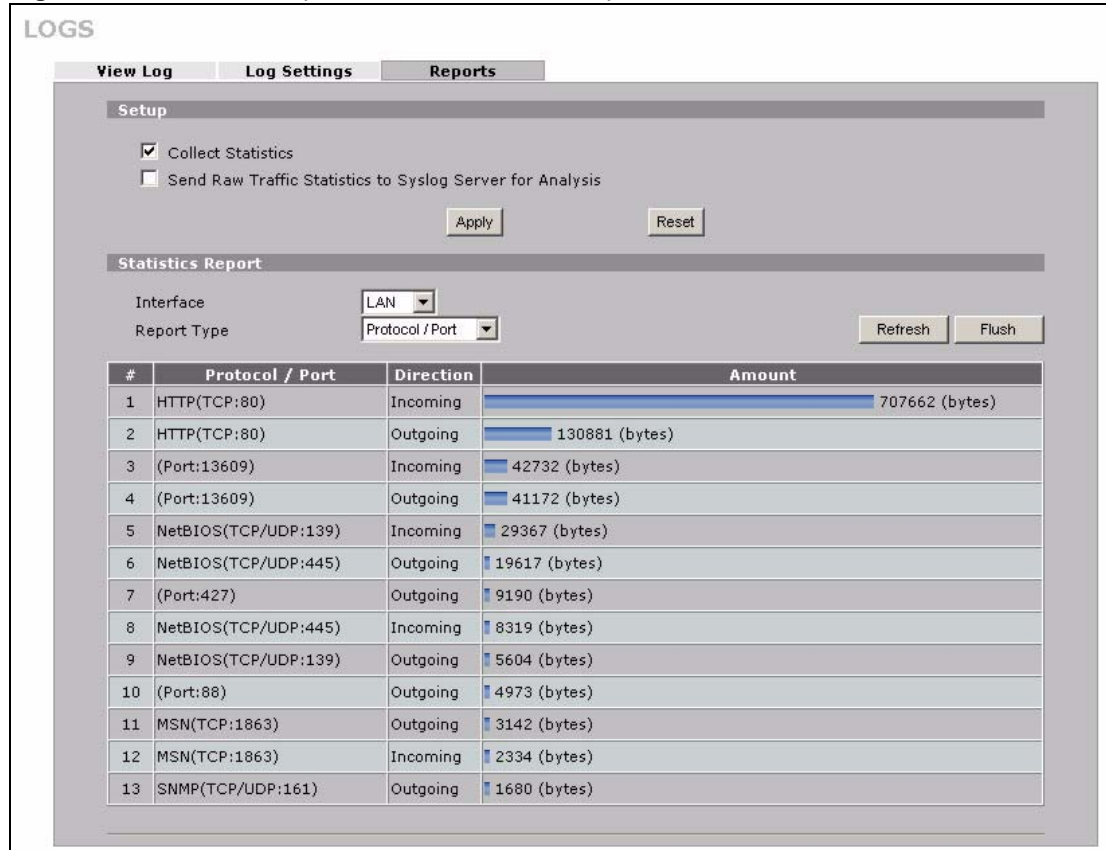
Figure 261 LOGS > Reports: Protocol/Port Example

The following table describes the labels in this screen.

Table 127 LOGS > Reports: Protocol/ Port

LABEL	DESCRIPTION
Protocol/Port	This column lists the protocols or service ports for which the most traffic has gone through the ZyWALL. The protocols or service ports are listed in descending order with the most used protocol or service port listed first.
Direction	This field displays Incoming to denote traffic that is coming in from the WAN to the LAN, DMZ or WLAN. This field displays Outgoing to denote traffic that is going out from the LAN, DMZ or WLAN to the WAN.
Amount	This column lists how much traffic has been sent and/or received for each protocol or service port. The measurement unit shown (bytes, Kbytes, Mbytes or Gbytes) varies with the amount of traffic for the particular protocol or service port. The count starts over at 0 if a protocol or port passes the bytes count limit (see Table 128 on page 402).

24.4.4 System Reports Specifications

The following table lists detailed specifications on the reports feature.

Table 128 Report Specifications

LABEL	DESCRIPTION
Number of web sites/protocols or ports/IP addresses listed:	20
Hit count limit:	Up to 2^{32} hits can be counted per web site. The count starts over at 0 if it passes four billion.
Bytes count limit:	Up to 2^{64} bytes can be counted per protocol/port or LAN IP address. The count starts over at 0 if it passes 2^{64} bytes.

24.5 Log Descriptions

This section provides descriptions of example log messages.

Table 129 System Maintenance Logs

LOG MESSAGE	DESCRIPTION
Time calibration is successful	The router has adjusted its time based on information from the time server.
Time calibration failed	The router failed to get information from the time server.
WAN interface gets IP: %s	A WAN interface got a new IP address from the DHCP, PPPoE, PPTP or dial-up server.
DHCP client IP expired	A DHCP client's IP address has expired.
DHCP server assigns %s	The DHCP server assigned an IP address to a client.
Successful SMT login	Someone has logged on to the router's SMT interface.
SMT login failed	Someone has failed to log on to the router's SMT interface.
Successful WEB login	Someone has logged on to the router's web configurator interface.
WEB login failed	Someone has failed to log on to the router's web configurator interface.
Successful TELNET login	Someone has logged on to the router via telnet.
TELNET login failed	Someone has failed to log on to the router via telnet.
Successful FTP login	Someone has logged on to the router via FTP.
FTP login failed	Someone has failed to log on to the router via FTP.
NAT Session Table is Full!	The maximum number of NAT session table entries has been exceeded and the table is full.
Starting Connectivity Monitor	Starting Connectivity Monitor.
Time initialized by Daytime Server	The router got the time and date from the Daytime server.
Time initialized by Time server	The router got the time and date from the time server.

Table 129 System Maintenance Logs (continued)

LOG MESSAGE	DESCRIPTION
Time initialized by NTP server	The router got the time and date from the NTP server.
Connect to Daytime server fail	The router was not able to connect to the Daytime server.
Connect to Time server fail	The router was not able to connect to the Time server.
Connect to NTP server fail	The router was not able to connect to the NTP server.
Too large ICMP packet has been dropped	The router dropped an ICMP packet that was too large.
SMT Session Begin	An SMT management session has started.
SMT Session End	An SMT management session has ended.
Configuration Change: PC = 0x%x, Task ID = 0x%x	The router is saving configuration changes.
Successful SSH login	Someone has logged on to the router's SSH server.
SSH login failed	Someone has failed to log on to the router's SSH server.
Successful HTTPS login	Someone has logged on to the router's web configurator interface using HTTPS protocol.
HTTPS login failed	Someone has failed to log on to the router's web configurator interface using HTTPS protocol.
DNS server %s was not responding to last 32 consecutive queries..	The specified DNS server did not respond to the last 32 consecutive queries.
DDNS update IP:%s (host %d) successfully	The device updated the IP address of the specified DDNS host name.
SMTP successfully	The device sent an e-mail.
myZyXEL.com registration successful	Registration of the device with myZyXEL.com was successful.
Trial service registration successful	Registration for a trial service was successful.
Service upgrade successful	Registration for a service upgrade was successful.
Service refresh successful.	The device successfully refreshed service information from myZyXEL.com.
Content Filter trial service activation successfully	The content filtering trial service was successfully activated for this device.
%s	The myZyXEL.com service registration failed due to the error listed. If you are unable to register for services at myZYXEL.com, the error message displayed in this log may be useful when contacting customer support.

Table 130 System Error Logs

LOG MESSAGE	DESCRIPTION
%s exceeds the max. number of session per host!	This attempt to create a NAT session exceeds the maximum number of NAT session table entries allowed to be created per host.
setNetBIOSFilter: calloc error	The router failed to allocate memory for the NetBIOS filter settings.
readNetBIOSFilter: calloc error	The router failed to allocate memory for the NetBIOS filter settings.
WAN connection is down.	A WAN connection is down. You cannot access the network through this interface.
Dial Backup starts	Dial backup started working.
Dial Backup ends	Dial backup stopped working.
DHCP Server cannot assign the static IP %S (out of range).	The LAN subnet, LAN alias 1, or LAN alias 2 was changed and the specified static DHCP IP addresses are no longer valid.
The DHCP static IP %s is conflict.	The static DHCP IP address conflicts with another host.
SMTP fail (%s)	The device failed to send an e-mail (error message included).
SMTP authentication fail (%s)	The device failed to authenticate with the SMTP server (error message included).

Table 131 Access Control Logs

LOG MESSAGE	DESCRIPTION
Firewall default policy: [TCP UDP IGMP ESP GRE OSPF] <Packet Direction>	Attempted TCP/UDP/IGMP/ESP/GRE/OSPF access matched the default policy and was blocked or forwarded according to the default policy's setting.
Firewall rule [NOT] match:[TCP UDP IGMP ESP GRE OSPF] <Packet Direction>, <rule:%d>	Attempted TCP/UDP/IGMP/ESP/GRE/OSPF access matched (or did not match) a configured firewall rule (denoted by its number) and was blocked or forwarded according to the rule.
Triangle route packet forwarded: [TCP UDP IGMP ESP GRE OSPF]	The firewall allowed a triangle route session to pass through.
Packet without a NAT table entry blocked: [TCP UDP IGMP ESP GRE OSPF]	The router blocked a packet that didn't have a corresponding NAT table entry.
Router sent blocked web site message: TCP	The router sent a message to notify a user that the router blocked access to a web site that the user requested.
Exceed maximum sessions per host (%d).	The device blocked a session because the host's connections exceeded the maximum sessions per host.
Firewall allowed a packet that matched a NAT session: [TCP UDP]	A packet from the WAN (TCP or UDP) matched a cone NAT session and the device forwarded it to the LAN.

Table 132 TCP Reset Logs

LOG MESSAGE	DESCRIPTION
Under SYN flood attack, sent TCP RST	The router sent a TCP reset packet when a host was under a SYN flood attack (the TCP incomplete count is per destination host.)
Exceed TCP MAX incomplete, sent TCP RST	The router sent a TCP reset packet when the number of TCP incomplete connections exceeded the user configured threshold. (the TCP incomplete count is per destination host.) Note: Refer to TCP Maximum Incomplete in the Firewall Attack Alerts screen.
Peer TCP state out of order, sent TCP RST	The router sent a TCP reset packet when a TCP connection state was out of order. Note: The firewall refers to RFC793 Figure 6 to check the TCP state.
Firewall session time out, sent TCP RST	The router sent a TCP reset packet when a dynamic firewall session timed out. The default timeout values are as follows: ICMP idle timeout: 3 minutes UDP idle timeout: 3 minutes TCP connection (three way handshaking) timeout: 270 seconds TCP FIN-wait timeout: 2 MSL (Maximum Segment Lifetime set in the TCP header). TCP idle (established) timeout (s): 150 minutes TCP reset timeout: 10 seconds
Exceed MAX incomplete, sent TCP RST	The router sent a TCP reset packet when the number of incomplete connections (TCP and UDP) exceeded the user-configured threshold. (Incomplete count is for all TCP and UDP connections through the firewall.) Note: When the number of incomplete connections (TCP + UDP) > "Maximum Incomplete High", the router sends TCP RST packets for TCP connections and destroys TOS (firewall dynamic sessions) until incomplete connections < "Maximum Incomplete Low".
Access block, sent TCP RST	The router sends a TCP RST packet and generates this log if you turn on the firewall TCP reset mechanism (via CLI command: "sys firewall tcprst").

Table 133 Packet Filter Logs

LOG MESSAGE	DESCRIPTION
[TCP UDP ICMP IGMP Generic] packet filter matched (set: %d, rule: %d)	Attempted access matched a configured filter rule (denoted by its set and rule number) and was blocked or forwarded according to the rule.

For type and code details, see [Table 145 on page 415](#).

Table 134 ICMP Logs

LOG MESSAGE	DESCRIPTION
Firewall default policy: ICMP <Packet Direction>, <type:%d>, <code:%d>	ICMP access matched the default policy and was blocked or forwarded according to the user's setting.
Firewall rule [NOT] match: ICMP <Packet Direction>, <rule:%d>, <type:%d>, <code:%d>	ICMP access matched (or didn't match) a firewall rule (denoted by its number) and was blocked or forwarded according to the rule.
Triangle route packet forwarded: ICMP	The firewall allowed a triangle route session to pass through.

Table 134 ICMP Logs (continued)

LOG MESSAGE	DESCRIPTION
Packet without a NAT table entry blocked: ICMP	The router blocked a packet that didn't have a corresponding NAT table entry.
Unsupported/out-of-order ICMP: ICMP	The firewall does not support this kind of ICMP packets or the ICMP packets are out of order.
Router reply ICMP packet: ICMP	The router sent an ICMP reply packet to the sender.

Table 135 CDR Logs

LOG MESSAGE	DESCRIPTION
board %d line %d channel %d, call %d, %s C01 Outgoing Call dev=%x ch=%x %s	The router received the setup requirements for a call. "call" is the reference (count) number of the call. "dev" is the device type (3 is for dial-up, 6 is for PPPoE, 10 is for PPTP). "channel" or "ch" is the call channel ID. For example, "board 0 line 0 channel 0, call 3, C01 Outgoing Call dev=6 ch=0" Means the router has dialed to the PPPoE server 3 times.
board %d line %d channel %d, call %d, %s C02 OutCall Connected %d %s	The PPPoE, PPTP or dial-up call is connected.
board %d line %d channel %d, call %d, %s C02 Call Terminated	The PPPoE, PPTP or dial-up call was disconnected.

Table 136 PPP Logs

LOG MESSAGE	DESCRIPTION
ppp:LCP Starting	The PPP connection's Link Control Protocol stage has started.
ppp:LCP Opening	The PPP connection's Link Control Protocol stage is opening.
ppp:CHAP Opening	The PPP connection's Challenge Handshake Authentication Protocol stage is opening.
ppp:IPCP Starting	The PPP connection's Internet Protocol Control Protocol stage is starting.
ppp:IPCP Opening	The PPP connection's Internet Protocol Control Protocol stage is opening.
ppp:LCP Closing	The PPP connection's Link Control Protocol stage is closing.
ppp:IPCP Closing	The PPP connection's Internet Protocol Control Protocol stage is closing.

Table 137 UPnP Logs

LOG MESSAGE	DESCRIPTION
UPnP pass through Firewall	UPnP packets can pass through the firewall.

Table 138 Content Filtering Logs

LOG MESSAGE	DESCRIPTION
%s: Keyword blocking	The content of a requested web page matched a user defined keyword.
%s: Not in trusted web list	The web site is not in a trusted domain, and the router blocks all traffic except trusted domain sites.
%s: Forbidden Web site	The web site is in the forbidden web site list.
%s: Contains ActiveX	The web site contains ActiveX.
%s: Contains Java applet	The web site contains a Java applet.
%s: Contains cookie	The web site contains a cookie.
%s: Proxy mode detected	The router detected proxy mode in the packet.
%s	The content filter server responded that the web site is in the blocked category list, but it did not return the category type.
%s: %s	The content filter server responded that the web site is in the blocked category list, and returned the category type.
%s (cache hit)	The system detected that the web site is in the blocked list from the local cache, but does not know the category type.
%s :%s (cache hit)	The system detected that the web site is in blocked list from the local cache, and knows the category type.
%s: Trusted Web site	The web site is in a trusted domain.
%s	When the content filter is not on according to the time schedule or you didn't select the "Block Matched Web Site" check box, the system forwards the web content.
Waiting content filter server timeout	The external content filtering server did not respond within the timeout period.
DNS resolving failed	The ZyWALL cannot get the IP address of the external content filtering via DNS query.
Creating socket failed	The ZyWALL cannot issue a query because TCP/IP socket creation failed, port:port number.
Connecting to content filter server fail	The connection to the external content filtering server failed.
License key is invalid	The external content filtering license key is invalid.

For type and code details, see [Table 145 on page 415](#).

Table 139 Attack Logs

LOG MESSAGE	DESCRIPTION
attack [TCP UDP IGMP ESP GRE OSPF]	The firewall detected a TCP/UDP/IGMP/ESP/GRE/OSPF attack.
attack ICMP (type:%d, code:%d)	The firewall detected an ICMP attack.
land [TCP UDP IGMP ESP GRE OSPF]	The firewall detected a TCP/UDP/IGMP/ESP/GRE/OSPF land attack.
land ICMP (type:%d, code:%d)	The firewall detected an ICMP land attack.

Table 139 Attack Logs (continued)

LOG MESSAGE	DESCRIPTION
ip spoofing - WAN [TCP UDP IGMP ESP GRE OSPF]	The firewall detected an IP spoofing attack on the WAN port.
ip spoofing - WAN ICMP (type:%d, code:%d)	The firewall detected an ICMP IP spoofing attack on the WAN port.
icmp echo : ICMP (type:%d, code:%d)	The firewall detected an ICMP echo attack.
syn flood TCP	The firewall detected a TCP syn flood attack.
ports scan TCP	The firewall detected a TCP port scan attack.
teardrop TCP	The firewall detected a TCP teardrop attack.
teardrop UDP	The firewall detected an UDP teardrop attack.
teardrop ICMP (type:%d, code:%d)	The firewall detected an ICMP teardrop attack.
illegal command TCP	The firewall detected a TCP illegal command attack.
NetBIOS TCP	The firewall detected a TCP NetBIOS attack.
ip spoofing - no routing entry [TCP UDP IGMP ESP GRE OSPF]	The firewall classified a packet with no source routing entry as an IP spoofing attack.
ip spoofing - no routing entry ICMP (type:%d, code:%d)	The firewall classified an ICMP packet with no source routing entry as an IP spoofing attack.
vulnerability ICMP (type:%d, code:%d)	The firewall detected an ICMP vulnerability attack.
traceroute ICMP (type:%d, code:%d)	The firewall detected an ICMP traceroute attack.
ports scan UDP	The firewall detected a UDP port scan attack.
Firewall sent TCP packet in response to DoS attack TCP	The firewall sent TCP packet in response to a DoS attack
ICMP Source Quench ICMP	The firewall detected an ICMP Source Quench attack.
ICMP Time Exceed ICMP	The firewall detected an ICMP Time Exceed attack.
ICMP Destination Unreachable ICMP	The firewall detected an ICMP Destination Unreachable attack.
ping of death. ICMP	The firewall detected an ICMP ping of death attack.
smurf ICMP	The firewall detected an ICMP smurf attack.
IP address in FTP port command is different from the client IP address. It maybe a bounce attack.	The IP address in an FTP port command is different from the client IP address. It may be a bounce attack.
Fragment packet size is smaller than the MTU size of output interface.	The fragment packet size is smaller than the MTU size of output interface.

Table 140 Remote Management Logs

LOG MESSAGE	DESCRIPTION
Remote Management: FTP denied	Attempted use of FTP service was blocked according to remote management settings.
Remote Management: TELNET denied	Attempted use of TELNET service was blocked according to remote management settings.
Remote Management: HTTP or UPnP denied	Attempted use of HTTP or UPnP service was blocked according to remote management settings.
Remote Management: WWW denied	Attempted use of WWW service was blocked according to remote management settings.
Remote Management: HTTPS denied	Attempted use of HTTPS service was blocked according to remote management settings.
Remote Management: SSH denied	Attempted use of SSH service was blocked according to remote management settings.
Remote Management: ICMP Ping response denied	Attempted use of ICMP service was blocked according to remote management settings.
Remote Management: SNMP denied	Attempted use of SNMP service was blocked according to remote management settings.
Remote Management: DNS denied	Attempted use of DNS service was blocked according to remote management settings.

Table 141 IPsec Logs

LOG MESSAGE	DESCRIPTION
Discard REPLAY packet	The router received and discarded a packet with an incorrect sequence number.
Inbound packet authentication failed	The router received a packet that has been altered. A third party may have altered or tampered with the packet.
Receive IPsec packet, but no corresponding tunnel exists	The router dropped an inbound packet for which SPI could not find a corresponding phase 2 SA.
Rule <%d> idle time out, disconnect	The router dropped a connection that had outbound traffic and no inbound traffic for a certain time period. You can use the "ipsec timer chk_conn" CLI command to set the time period. The default value is 2 minutes.
WAN IP changed to <IP>	The router dropped all connections with the "MyIP" configured as "0.0.0.0" when the WAN IP address changed.
Inbound packet decryption failed	Please check the algorithm configuration.
Cannot find outbound SA for rule <%d>	A packet matches a rule, but there is no phase 2 SA for outbound traffic.
Rule [%s] sends an echo request to peer	The device sent a ping packet to check the specified VPN tunnel's connectivity.
Rule [%s] receives an echo reply from peer	The device received a ping response when checking the specified VPN tunnel's connectivity.

Table 142 IKE Logs

LOG MESSAGE	DESCRIPTION
Active connection allowed exceeded	The IKE process for a new connection failed because the limit of simultaneous phase 2 SAs has been reached.
Start Phase 2: Quick Mode	Phase 2 Quick Mode has started.
Verifying Remote ID failed:	The connection failed during IKE phase 2 because the router and the peer's Local/Remote Addresses don't match.
Verifying Local ID failed:	The connection failed during IKE phase 2 because the router and the peer's Local/Remote Addresses don't match.
IKE Packet Retransmit	The router retransmitted the last packet sent because there was no response from the peer.
Failed to send IKE Packet	An Ethernet error stopped the router from sending IKE packets.
Too many errors! Deleting SA	An SA was deleted because there were too many errors.
Phase 1 IKE SA process done	The phase 1 IKE SA process has been completed.
Duplicate requests with the same cookie	The router received multiple requests from the same peer while still processing the first IKE packet from the peer.
IKE Negotiation is in process	The router has already started negotiating with the peer for the connection, but the IKE process has not finished yet.
No proposal chosen	Phase 1 or phase 2 parameters don't match. Please check all protocols / settings. Ex. One device being configured for 3DES and the other being configured for DES causes the connection to fail.
Local / remote IPs of incoming request conflict with rule <%d>	The security gateway is set to "0.0.0.0" and the router used the peer's "Local Address" as the router's "Remote Address". This information conflicted with static rule #d; thus the connection is not allowed.
Cannot resolve Secure Gateway Addr for rule <%d>	The router couldn't resolve the IP address from the domain name that was used for the secure gateway address.
Peer ID: <peer id> <My remote type> -<My local type>	The displayed ID information did not match between the two ends of the connection.
vs. My Remote <My remote> - <My remote>	The displayed ID information did not match between the two ends of the connection.
vs. My Local <My local>-<My local>	The displayed ID information did not match between the two ends of the connection.
Send <packet>	A packet was sent.
Recv <packet>	IKE uses ISAKMP to transmit data. Each ISAKMP packet contains many different types of payloads. All of them show in the LOG. Refer to RFC2408 – ISAKMP for a list of all ISAKMP payload types.
Recv <Main or Aggressive> Mode request from <IP>	The router received an IKE negotiation request from the peer address specified.
Send <Main or Aggressive> Mode request to <IP>	The router started negotiation with the peer.
Invalid IP <Peer local> / <Peer local>	The peer's "Local IP Address" is invalid.

Table 142 IKE Logs (continued)

LOG MESSAGE	DESCRIPTION
Remote IP <Remote IP> / <Remote IP> conflicts	The security gateway is set to "0.0.0.0" and the router used the peer's "Local Address" as the router's "Remote Address". This information conflicted with static rule #d; thus the connection is not allowed.
Phase 1 ID type mismatch	This router's "Peer ID Type" is different from the peer IPsec router's "Local ID Type".
Phase 1 ID content mismatch	This router's "Peer ID Content" is different from the peer IPsec router's "Local ID Content".
No known phase 1 ID type found	The router could not find a known phase 1 ID in the connection attempt.
ID type mismatch. Local / Peer: <Local ID type/Peer ID type>	The phase 1 ID types do not match.
ID content mismatch	The phase 1 ID contents do not match.
Configured Peer ID Content: <Configured Peer ID Content>	The phase 1 ID contents do not match and the configured "Peer ID Content" is displayed.
Incoming ID Content: <Incoming Peer ID Content>	The phase 1 ID contents do not match and the incoming packet's ID content is displayed.
Unsupported local ID Type: <%d>	The phase 1 ID type is not supported by the router.
Build Phase 1 ID	The router has started to build the phase 1 ID.
Adjust TCP MSS to %d	The router automatically changed the TCP Maximum Segment Size value after establishing a tunnel.
Rule <%d> input idle time out, disconnect	The tunnel for the listed rule was dropped because there was no inbound traffic within the idle timeout period.
XAUTH succeed! Username: <Username>	The router used extended authentication to authenticate the listed username.
XAUTH fail! Username: <Username>	The router was not able to use extended authentication to authenticate the listed username.
Rule[%d] Phase 1 negotiation mode mismatch	The listed rule's IKE phase 1 negotiation mode did not match between the router and the peer.
Rule [%d] Phase 1 encryption algorithm mismatch	The listed rule's IKE phase 1 encryption algorithm did not match between the router and the peer.
Rule [%d] Phase 1 authentication algorithm mismatch	The listed rule's IKE phase 1 authentication algorithm did not match between the router and the peer.
Rule [%d] Phase 1 authentication method mismatch	The listed rule's IKE phase 1 authentication method did not match between the router and the peer.
Rule [%d] Phase 1 key group mismatch	The listed rule's IKE phase 1 key group did not match between the router and the peer.
Rule [%d] Phase 2 protocol mismatch	The listed rule's IKE phase 2 protocol did not match between the router and the peer.
Rule [%d] Phase 2 encryption algorithm mismatch	The listed rule's IKE phase 2 encryption algorithm did not match between the router and the peer.

Table 142 IKE Logs (continued)

LOG MESSAGE	DESCRIPTION
Rule [%d] Phase 2 authentication algorithm mismatch	The listed rule's IKE phase 2 authentication algorithm did not match between the router and the peer.
Rule [%d] Phase 2 encapsulation mismatch	The listed rule's IKE phase 2 encapsulation did not match between the router and the peer.
Rule [%d]> Phase 2 pfs mismatch	The listed rule's IKE phase 2 perfect forward secret (PFS) setting did not match between the router and the peer.
Rule [%d] Phase 1 ID mismatch	The listed rule's IKE phase 1 ID did not match between the router and the peer.
Rule [%d] Phase 1 hash mismatch	The listed rule's IKE phase 1 hash did not match between the router and the peer.
Rule [%d] Phase 1 preshared key mismatch	The listed rule's IKE phase 1 pre-shared key did not match between the router and the peer.
Rule [%d] Tunnel built successfully	The listed rule's IPsec tunnel has been built successfully.
Rule [%d] Peer's public key not found	The listed rule's IKE phase 1 peer's public key was not found.
Rule [%d] Verify peer's signature failed	The listed rule's IKE phase 1 verification of the peer's signature failed.
Rule [%d] Sending IKE request	IKE sent an IKE request for the listed rule.
Rule [%d] Receiving IKE request	IKE received an IKE request for the listed rule.
Swap rule to rule [%d]	The router changed to using the listed rule.
Rule [%d] Phase 1 key length mismatch	The listed rule's IKE phase 1 key length (with the AES encryption algorithm) did not match between the router and the peer.
Rule [%d] phase 1 mismatch	The listed rule's IKE phase 1 did not match between the router and the peer.
Rule [%d] phase 2 mismatch	The listed rule's IKE phase 2 did not match between the router and the peer.
Rule [%d] Phase 2 key length mismatch	The listed rule's IKE phase 2 key lengths (with the AES encryption algorithm) did not match between the router and the peer.
Remote Gateway Addr in rule [%s] is changed to %s"	The IP address for the domain name of the peer gateway in the listed rule changed to the listed IP address.
New My ZyWALL Addr in rule [%s] is changed to %s	The IP address for the domain name of the ZyWALL in the listed rule changed to the listed IP address.
Remote Gateway Addr has changed, tunnel [%s] will be deleted	The listed tunnel will be deleted because the remote gateway's IP address changed.
My ZyWALL Addr has changed, tunnel [%s] will be deleted	The listed tunnel will be deleted because the ZyWALL's IP address changed.

Table 143 PKI Logs

LOG MESSAGE	DESCRIPTION
Enrollment successful	The SCEP online certificate enrollment was successful. The Destination field records the certification authority server IP address and port.
Enrollment failed	The SCEP online certificate enrollment failed. The Destination field records the certification authority server's IP address and port.
Failed to resolve <SCEP CA server url>	The SCEP online certificate enrollment failed because the certification authority server's address cannot be resolved.
Enrollment successful	The CMP online certificate enrollment was successful. The Destination field records the certification authority server's IP address and port.
Enrollment failed	The CMP online certificate enrollment failed. The Destination field records the certification authority server's IP address and port.
Failed to resolve <CMP CA server url>	The CMP online certificate enrollment failed because the certification authority server's IP address cannot be resolved.
Rcvd ca cert: <subject name>	The router received a certification authority certificate, with subject name as recorded, from the LDAP server whose IP address and port are recorded in the Source field.
Rcvd user cert: <subject name>	The router received a user certificate, with subject name as recorded, from the LDAP server whose IP address and port are recorded in the Source field.
Rcvd CRL <size>: <issuer name>	The router received a CRL (Certificate Revocation List), with size and issuer name as recorded, from the LDAP server whose IP address and port are recorded in the Source field.
Rcvd ARL <size>: <issuer name>	The router received an ARL (Authority Revocation List), with size and issuer name as recorded, from the LDAP server whose address and port are recorded in the Source field.
Failed to decode the received ca cert	The router received a corrupted certification authority certificate from the LDAP server whose address and port are recorded in the Source field.
Failed to decode the received user cert	The router received a corrupted user certificate from the LDAP server whose address and port are recorded in the Source field.
Failed to decode the received CRL	The router received a corrupted CRL (Certificate Revocation List) from the LDAP server whose address and port are recorded in the Source field.
Failed to decode the received ARL	The router received a corrupted ARL (Authority Revocation List) from the LDAP server whose address and port are recorded in the Source field.
Rcvd data <size> too large! Max size allowed: <max size>	The router received directory data that was too large (the size is listed) from the LDAP server whose address and port are recorded in the Source field. The maximum size of directory data that the router allows is also recorded.
Cert trusted: <subject name>	The router has verified the path of the certificate with the listed subject name.
Due to <reason codes>, cert not trusted: <subject name>	Due to the reasons listed, the certificate with the listed subject name has not passed the path verification. The recorded reason codes are only approximate reasons for not trusting the certificate. Please see Table 150 on page 414 for the corresponding descriptions of the codes.

CODE	DESCRIPTION
1	Algorithm mismatch between the certificate and the search constraints.
2	Key usage mismatch between the certificate and the search constraints.
3	Certificate was not valid in the time interval.
4	(Not used)
5	Certificate is not valid.
6	Certificate signature was not verified correctly.
7	Certificate was revoked by a CRL.
8	Certificate was not added to the cache.
9	Certificate decoding failed.
10	Certificate was not found (anywhere).
11	Certificate chain looped (did not find trusted root).
12	Certificate contains critical extension that was not handled.
13	Certificate issuer was not valid (CA specific information missing).
14	(Not used)
15	CRL is too old.
16	CRL is not valid.
17	CRL signature was not verified correctly.
18	CRL was not found (anywhere).
19	CRL was not added to the cache.
20	CRL decoding failed.
21	CRL is not currently valid, but in the future.
22	CRL contains duplicate serial numbers.
23	Time interval is not continuous.
24	Time information not available.
25	Database method failed due to timeout.
26	Database method failed.
27	Path was not verified.
28	Maximum path length reached.

Table 144 ACL Setting Notes

PACKET DIRECTION	DIRECTION	DESCRIPTION
(L to W)	LAN to WAN	ACL set for packets traveling from the LAN to the WAN.
(W to L)	WAN to LAN	ACL set for packets traveling from the WAN to the LAN.
(D to L)	DMZ to LAN	ACL set for packets traveling from the DMZ to the LAN.
(D to W)	DMZ to WAN	ACL set for packets traveling from the DMZ to the WAN.
(W to D)	WAN to DMZ	ACL set for packets traveling from the WAN to the DMZ.
(L to D)	LAN to DMZ	ACL set for packets traveling from the LAN to the DMZ.

Table 144 ACL Setting Notes (continued)

PACKET DIRECTION	DIRECTION	DESCRIPTION
(L to L/ZW)	LAN to LAN/ ZyWALL	ACL set for packets traveling from the LAN to the LAN or the ZyWALL.
(W to W/ZW)	WAN to WAN/ ZyWALL	ACL set for packets traveling from the WAN to the WAN or the ZyWALL.
(D to D/ZW)	DMZ to DMZ/ ZyWALL	ACL set for packets traveling from the DMZ to the DM or the ZyWALL.
(L to WL)	LAN to WLAN	ACL set for packets traveling from the LAN to the WLAN.
(WL to L)	WLAN to LAN	ACL set for packets traveling from the WLAN to the LAN.
(W to WL)	WAN to WLAN	ACL set for packets traveling from the WAN to the WLAN.
(WL to W)	WLAN to WAN	ACL set for packets traveling from the WLAN to the WAN.
(D to WL)	DMZ to WLAN	ACL set for packets traveling from the DMZ to the WLAN.
(WL to D)	WLAN to DMZ	ACL set for packets traveling from the WLAN to the DMZ.
(WL to WL)	WLAN to WLAN/ ZyWALL	ACL set for packets traveling from the WLAN to the WLAN or the ZyWALL.

Table 145 ICMP Notes

TYPE	CODE	DESCRIPTION
0		Echo Reply
	0	Echo reply message
3		Destination Unreachable
	0	Net unreachable
	1	Host unreachable
	2	Protocol unreachable
	3	Port unreachable
	4	A packet that needed fragmentation was dropped because it was set to Don't Fragment (DF)
	5	Source route failed
4		Source Quench
	0	A gateway may discard internet datagrams if it does not have the buffer space needed to queue the datagrams for output to the next network on the route to the destination network.
5		Redirect
	0	Redirect datagrams for the Network
	1	Redirect datagrams for the Host
	2	Redirect datagrams for the Type of Service and Network
	3	Redirect datagrams for the Type of Service and Host
8		Echo
	0	Echo message
11		Time Exceeded

Table 145 ICMP Notes (continued)

TYPE	CODE	DESCRIPTION
	0	Time to live exceeded in transit
	1	Fragment reassembly time exceeded
12		Parameter Problem
	0	Pointer indicates the error
13		Timestamp
	0	Timestamp request message
14		Timestamp Reply
	0	Timestamp reply message
15		Information Request
	0	Information request message
16		Information Reply
	0	Information reply message

Table 146 IDP Logs

LOG MESSAGE	DESCRIPTION
The buffer size is too small!	The buffer for holding IDP information such as the signature file version was too small to hold any more information.
The format of the user config file is incorrect!	There was a format error in the configuration backup file that someone attempted to load into the system.
The system is doing signature update now , please wait!	The device is updating the signature file.
No data!	The system could not find any IDP signatures that matched a search.
IDP %s!	The device detected an intrusion event in a connection. The format of %s is "ID" followed by the IDP ID signature number and the IDP signature name. For example, ID:10001,Window Ping.
Can not find the signature , please update the signature!	The device does not have a signature file loaded.
Failed in signature update - %s!	The device failed to update the signature file through the Internet. %s describes the reason for the error. You may need to provide the error message when contacting customer support if you are repeatedly unable to download the signature file from the update server.
Check signature version - %s.	The device attempted to check for the latest available signature version. %s gives details. Either the check was unsuccessful due to the server being busy or the device is already using the latest available firmware.

Table 146 IDP Logs (continued)

LOG MESSAGE	DESCRIPTION
Signature update OK - New signature version: <Signature version> Release Date: <Release date>!	The device updated the signature file successfully. The signature file's version and release date are included.
The turbo card is not ready , please insert the card and reboot!	The turbo card is not installed.

Table 147 AV Logs

LOG MESSAGE	DESCRIPTION
HTTP Virus infected - %s!	The device detected a virus in an HTTP connection. The format of %s is "ID" Virus ID number, virus name, filename. For example, ID:30001,CIH.Win95,/game.exe.
FTPDATA Virus infected - %s!	The device detected a virus in a FTPDATA connection. The format of %s is "ID" Virus ID number, virus name, filename. For example, ID:30001,CIH.Win95,/game.exe.
SMTP Virus infected - %s!	The device detected a virus in a SMTP connection. The format of %s is "ID" Virus ID number, virus name, filename. For example, ID:30001,CIH.Win95,/game.exe.
POP3 Virus infected - %s!	The device detected a virus in a POP3 connection. The format of %s is "ID" Virus ID number, virus name, filename. For example, ID:30001,CIH.Win95,/game.exe.
HTTP Bypass - %s!	The device bypassed the scanning of files in HTTP connections. %s is the filename. For example, game.zip.
FTPDATA Bypass - %s!	The device bypassed the scanning of files in FTP data connections. %s is the filename. For example, game.zip.
SMTP Bypass - %s!	The device bypassed the scanning of files in SMTP connections. %s is the filename. For example, game.zip.
POP3 Bypass - %s!	The device bypassed the scanning of files in POP3 connections. %s is the filename. For example, game.zip.
Can not find the signature , please update the signature!	The device does not have a signature file loaded.
Failed in signature update - %s!	The device failed to update the signature file through the Internet. %s describes the reason for the error. You may need to provide the error message when contacting customer support if you are repeatedly unable to download the signature file from the update server.
Check signature version - %s.	The device attempted to check for the latest available signature version. %s gives details. Either the check was unsuccessful due to the server being busy or the device is already using the latest available firmware.
Update the signature file successfully.	The device updated the signature file successfully.

Table 147 AV Logs (continued)

LOG MESSAGE	DESCRIPTION
The turbo card is not ready , please insert the card and reboot!	The turbo card is not installed.
The system is doing signature update now , please wait!	The device is updating the signature file.

Table 148 AS Logs

LOG MESSAGE	DESCRIPTION
Mail is in the Black List - Mail From:%EMAIL_ADDRESS% Subject:%MAIL_SUBJECT%!	An e-mail with the listed source and subject matched an anti-spam blacklist entry.
Mail score is higher or equal than threshold - Spam Score:%d Mail From:%EMAIL_ADDRESS% Subject:%MAIL_SUBJECT%!	The spam score (listed) for the e-mail with the listed source and subject was higher than or equal to the spam score threshold.
Query external database timeout - [%Rating Server IP Address%]	The anti-spam external database query timed out. The following log identifies the e-mail that was being checked.
Mail From:Email address Subject:Mail Subject!	This is the source and subject of an e-mail for which the anti-spam external database query failed.
External database query failed - [%Rating Server IP Address%] %s!	An anti-spam external database query failed due to an error, such as Http Error 404, Http connection can't be built. Please refer to "reason" field. The following log identifies the e-mail that was being checked.
Mail From:Email address Subject:Mail Subject!	This is the source and subject of an e-mail for which the anti-spam external database query failed.
Exceed maximum mail sessions (%d).	The number of concurrent mail sessions went over the limit (%d).
Error code from anti-spam server - [%Rating Server IP Address%] %s!	The device received an error code from the anti-spam external database server. Please refer to "reason" field. The following log identifies the e-mail that was being checked.
Mail From:Email address Subject:Mail Subject!	This is the source and subject of an e-mail for which the anti-spam external database query failed.
Unknown anti-spam query response - [%Rating Server IP Address%]!	The device received a response with an unknown format from the anti-spam external database server. The following log identifies the e-mail that was being checked.
Mail From:Email address Subject:Mail Subject!	This is the source and subject of an e-mail for which the anti-spam external database query failed.
Remove rating server [%Rating Server IP Address%] from server list!	The listed server IP address has been removed from the list of anti-spam external database servers.

Table 148 AS Logs (continued)

LOG MESSAGE	DESCRIPTION
"This is a phishing mail - Spam Score:%d Mail From:%EMAIL_ADDRESS% Subject:%MAIL_SUBJECT%! "	The spam score (listed) for the e-mail with the listed source and subject was higher than the spam score threshold. The anti-spam external database identified the e-mail as a phishing mail.
Invalid parameter for AsEngine!	There was an internal AS system error. This type of error causes the device to restart.
Mail Parser buffer is overflow!	There were too many characters in a single line of an e-mail header that the device was attempting to parse.
There is no available HTTP session for external database!	There was not an HTTP session available to query the external database.
Mail From:Email address Subject:Mail Subject!	This is the source and subject of an e-mail for which there was not an HTTP session available for queuing the external database.
Mail Digest creating failed!	The device was not able to create a digest of an e-mail.
Mail From:Email address Subject:Mail Subject!	This is the source and subject of an e-mail for which the device was not able to create a digest.
There is no available timer for external database!	There was not an internal timer mechanism free for the anti-spam feature to use when sending a query to the external database.
Mail From:Email address Subject:Mail Subject!	This is the source and subject of an e-mail for which there was not an internal timer mechanism available for queuing the external database.
There is no available HTTP session and timer for external database!	There was not an HTTP session available to query the external database. There also was not an internal timer mechanism free for the anti-spam feature to use when sending a query to the external database.
Mail From:Email address Subject:Mail Subject!	This is the source and subject of an e-mail for which there was no HTTP session and no internal timer mechanism available for queuing the external database.

24.6 Syslog Logs

There are two types of syslog: event logs and traffic logs. The device generates an event log when a system event occurs, for example, when a user logs in or the device is under attack. The device generates a traffic log when a "session" is terminated. A traffic log summarizes the session's type, when it started and stopped the amount of traffic that was sent and received and so on. An external log analyzer can reconstruct and analyze the traffic flowing through the device after collecting the traffic logs.

Table 149 Syslog Logs

LOG MESSAGE	DESCRIPTION
Event Log: <Facility*8 + Severity>Mon dd hr:mm:ss hostname src="<srcIP:srcPort>" dst="<dstIP:dstPort>" msg="<msg>" note="<note>" devID="<mac address>" cat="<category>"	This message is sent by the system ("RAS" displays as the system name if you haven't configured one) when the router generates a syslog. The facility is defined in the web MAIN MENU, LOGS, Log Settings page. The severity is the log's syslog class. The definition of messages and notes are defined in the other log tables. The "devID" is the MAC address of the router's LAN port. The "cat" is the same as the category in the router's logs.
Traffic Log: <Facility*8 + Severity>Mon dd hr:mm:ss hostname src="<srcIP:srcPort>" dst="<dstIP:dstPort>" msg="Traffic Log" note="Traffic Log" devID="<mac address>" cat="Traffic Log" duration=seconds sent=sentBytes rcvd=receiveBytes dir="<from:to>" protoID=IPProtocolID proto="serviceName" trans="IPSec/Normal"	This message is sent by the device when the connection (session) is closed. The facility is defined in the Log Settings screen. The severity is the traffic log type. The message and note always display "Traffic Log". The "proto" field lists the service name. The "dir" field lists the incoming and outgoing interfaces ("LAN:LAN", "LAN:WAN", "LAN:DMZ", "LAN:DEV" for example).
Event Log: <Facility*8 + Severity>Mon dd hr:mm:ss hostname src="<srcIP:srcPort>" dst="<dstIP:dstPort>" ob="<0 1>" ob_mac="<mac address>" msg="<msg>" note="<note>" devID="<mac address>" cat="<category>"	This message is sent by the device ("RAS" displays as the system name if you haven't configured one) at the time when this syslog is generated. The facility is defined in the web MAIN MENU, LOGS, Log Settings page. The severity is the log's syslog class. The definition of messages and notes are defined in the other log tables. OB is the Out Break flag and the mac address of the Out Break PC.
Event Log: <Facility*8 + Severity>Mon dd hr:mm:ss hostname src="<srcIP:srcPort>" dst="<dstIP:dstPort>" ob="0 1" ob_mac="<mac address>" msg="<msg>" note="<note>" devID="<mac address>" cat="Anti Virus" encode="< uu b64 >"	This message is sent by the device ("RAS" displays as the system name if you haven't configured one) at the time when this syslog is generated. The facility is defined in the web MAIN MENU, LOGS, Log Settings page. The severity is the log's syslog class. The "encode" message indicates the mail attachments encoding method. The definition of messages and notes are defined in the Anti-Virus log descriptions.

Table 149 Syslog Logs (continued)

LOG MESSAGE	DESCRIPTION
Event Log: <Facility*8 + Severity>Mon dd hr:mm:ss hostname src="<srcIP:srcPort>" dst="<dstIP:dstPort>" ob="<0 1>" ob_mac="<mac address>" msg="<msg>" note="<note>" devID="<mac address>" cat="IDP" class="<idp class>" sid="<idp sid>" act="<idp action>" count="1"	This message is sent by the device ("RAS" displays as the system name if you haven't configured one) at the time when this syslog is generated. The facility is defined in the web MAIN MENU, LOGS, Log Settings page. The severity is the log's syslog class. The definition of messages and notes are defined in the IDP log descriptions.
Event Log: <Facility*8 + Severity>Mon dd hr:mm:ss hostname src="<srcIP:srcPort>" dst="<dstIP:dstPort>" ob="<0 1>" ob_mac="<mac address>" msg="<msg>" note="<note>" devID="<mac address>" cat="Anti Spam" 1stReIP="<IP>"	This message is sent by the device ("RAS" displays as the system name if you haven't configured one) at the time when this syslog is generated. The facility is defined in the web MAIN MENU, LOGS, Log Settings page. The severity is the log's syslog class. 1stReIP is the IP address of the first mail relay server. The definition of messages and notes are defined in the Anti-Spam log descriptions.

The following table shows RFC-2408 ISAKMP payload types that the log displays. Please refer to the RFC for detailed information on each type.

Table 150 RFC-2408 ISAKMP Payload Types

LOG DISPLAY	PAYLOAD TYPE
SA	Security Association
PROP	Proposal
TRANS	Transform
KE	Key Exchange
ID	Identification
CER	Certificate
CER_REQ	Certificate Request
HASH	Hash
SIG	Signature
NONCE	Nonce
NOTFY	Notification
DEL	Delete
VID	Vendor ID

Maintenance

This chapter displays information on the maintenance screens.

25.1 Maintenance Overview

The maintenance screens can help you view system information, upload new firmware, manage configuration and restart your ZyWALL.

25.2 General Setup and System Name

General Setup contains administrative and system-related information. **System Name** is for identification purposes. However, because some ISPs check this name you should enter your computer's "Computer Name".

- In Windows 95/98 click **Start, Settings, Control Panel, Network**. Click the **Identification** tab, note the entry for the **Computer Name** field and enter it as the **System Name**.
- In Windows 2000, click **Start, Settings, Control Panel** and then double-click **System**. Click the **Network Identification** tab and then the **Properties** button. Note the entry for the **Computer name** field and enter it as the **System Name**.
- In Windows XP, click **Start, My Computer, View system information** and then click the **Computer Name** tab. Note the entry in the **Full computer name** field and enter it as the **ZyWALL System Name**.

25.2.1 General Setup

Click **MAINTENANCE** to open the **General** screen. Use this screen to configure administrative and system-related information.

Figure 262 MAINTENANCE > General Setup

The following table describes the labels in this screen.

Table 151 MAINTENANCE > General Setup

LABEL	DESCRIPTION
General Setup	
System Name	Choose a descriptive name for identification purposes. It is recommended you enter your computer's "Computer name" in this field. This name can be up to 30 alphanumeric characters long. Spaces are not allowed, but dashes "-" and underscores "_" are accepted.
Domain Name	The Domain Name entry is what is propagated to the DHCP clients on the LAN. If you leave this blank, the domain name obtained by DHCP from the ISP is used. While you must enter the host name (System Name), the domain name can be assigned from the ZyWALL via DHCP. Enter the domain name (if you know it) here. If you leave this field blank, the ISP may assign a domain name via DHCP. The domain name entered by you is given priority over the ISP assigned domain name.
Administrator Inactivity Timer	Type how many minutes a management session (either via the web configurator or SMT) can be left idle before the session times out. The default is 5 minutes. After it times out you have to log in with your password again. Very long idle timeouts may have security risks. A value of "0" means a management session never times out, no matter how long it has been left idle (not recommended).
Apply	Click Apply to save your changes back to the ZyWALL.
Reset	Click Reset to begin configuring this screen afresh.

25.3 Configuring Password

Click **MAINTENANCE > Password** to open the following screen. Use this screen to change the ZyWALL's management password.

Figure 263 MAINTENANCE > Password

The following table describes the labels in this screen.

Table 152 MAINTENANCE > Password

LABEL	DESCRIPTION
Old Password	Type the default password or the existing password you use to access the system in this field. If you forget the password, you may have to use the hardware RESET button. This restores the default password of 1234.
New Password	Type your new system password (up to 30 characters). Note that as you type a password, the screen displays a (*) for each character you type.
Retype to Confirm	Type the new password again for confirmation.
Apply	Click Apply to save your changes back to the ZyWALL.
Reset	Click Reset to begin configuring this screen afresh.

25.4 Time and Date

The ZyWALL's Real Time Chip (RTC) keeps track of the time and date. There is also a software mechanism to set the time manually or get the current time and date from an external server when you turn on your ZyWALL.

To change your ZyWALL's time and date, click **MAINTENANCE > Time and Date**. The screen appears as shown. Use this screen to configure the ZyWALL's time based on your local time zone.

Figure 264 MAINTENANCE > Time and Date

The following table describes the labels in this screen.

Table 153 MAINTENANCE > Time and Date

LABEL	DESCRIPTION
Current Time and Date	
Current Time	This field displays the ZyWALL's present time.
Current Date	This field displays the ZyWALL's present date.
Time and Date Setup	
Manual	Select this radio button to enter the time and date manually. If you configure a new time and date, Time Zone and Daylight Saving at the same time, the new time and date you entered has priority and the Time Zone and Daylight Saving settings do not affect it.
New Time (hh:mm:ss)	This field displays the last updated time from the time server or the last time configured manually. When you set Time and Date Setup to Manual , enter the new time in this field and then click Apply .
New Date (yyyy-mm-dd)	This field displays the last updated date from the time server or the last date configured manually. When you set Time and Date Setup to Manual , enter the new date in this field and then click Apply .
Get from Time Server	Select this radio button to have the ZyWALL get the time and date from the time server you specified below.

Table 153 MAINTENANCE > Time and Date (continued)

LABEL	DESCRIPTION
Time Protocol	<p>Select the time service protocol that your time server uses. Not all time servers support all protocols, so you may have to check with your ISP/network administrator or use trial and error to find a protocol that works.</p> <p>The main difference between them is the format. Daytime (RFC 867) format is day/month/year/time zone of the server. Time (RFC 868) format displays a 4-byte integer giving the total number of seconds since 1970/1/1 at 0:0:0. The default, NTP (RFC 1305), is similar to Time (RFC 868).</p>
Time Server Address	<p>Enter the IP address or URL of your time server. Check with your ISP/network administrator if you are unsure of this information.</p>
Synchronize Now	<p>Click this button to have the ZyWALL get the time and date from a time server (see the Time Server Address field). This also saves your changes (including the time server address).</p>
Time Zone Setup	
Time Zone	<p>Choose the time zone of your location. This will set the time difference between your time zone and Greenwich Mean Time (GMT).</p>
Enable Daylight Saving	<p>Daylight saving is a period from late spring to early fall when many countries set their clocks ahead of normal local time by one hour to give more daytime light in the evening.</p> <p>Select this option if you use Daylight Saving Time.</p>
Start Date	<p>Configure the day and time when Daylight Saving Time starts if you selected Enable Daylight Saving. The o'clock field uses the 24 hour format. Here are a couple of examples:</p> <p>Daylight Saving Time starts in most parts of the United States on the first Sunday of April. Each time zone in the United States starts using Daylight Saving Time at 2 A.M. local time. So in the United States you would select First, Sunday, April and type 2 in the o'clock field.</p> <p>Daylight Saving Time starts in the European Union on the last Sunday of March. All of the time zones in the European Union start using Daylight Saving Time at the same moment (1 A.M. GMT or UTC). So in the European Union you would select Last, Sunday, March. The time you type in the o'clock field depends on your time zone. In Germany for instance, you would type 2 because Germany's time zone is one hour ahead of GMT or UTC (GMT+1).</p>
End Date	<p>Configure the day and time when Daylight Saving Time ends if you selected Enable Daylight Saving. The o'clock field uses the 24 hour format. Here are a couple of examples:</p> <p>Daylight Saving Time ends in the United States on the last Sunday of October. Each time zone in the United States stops using Daylight Saving Time at 2 A.M. local time. So in the United States you would select Last, Sunday, October and type 2 in the o'clock field.</p> <p>Daylight Saving Time ends in the European Union on the last Sunday of October. All of the time zones in the European Union stop using Daylight Saving Time at the same moment (1 A.M. GMT or UTC). So in the European Union you would select Last, Sunday, October. The time you type in the o'clock field depends on your time zone. In Germany for instance, you would type 2 because Germany's time zone is one hour ahead of GMT or UTC (GMT+1).</p>
Apply	<p>Click Apply to save your changes back to the ZyWALL.</p>
Reset	<p>Click Reset to begin configuring this screen afresh.</p>

25.5 Pre-defined NTP Time Server Pools

When you turn on the ZyWALL for the first time, the date and time start at 2000-01-01 00:00:00. The ZyWALL then attempts to synchronize with an NTP time server from one of the 0.pool.ntp.org, 1.pool.ntp.org or 2.pool.ntp.org NTP time server pools. These are virtual clusters of time servers that use a round robin method to provide different NTP servers to clients.

The ZyWALL continues to use the NTP time server pools if you do not specify a time server or it cannot synchronize with the time server you specified.



The ZyWALL can use the NTP time server pools regardless of the time protocol you select.

When the ZyWALL uses the NTP time server pools, it randomly selects one pool and tries to synchronize with a server in it. If the synchronization fails, then the ZyWALL goes through the rest of the list in order from the first one tried until either it is successful or all the pre-defined NTP time server pools have been tried.

25.5.1 Resetting the Time

The ZyWALL resets the time in the following instances:

- When you click **Synchronize Now**.
- On saving your changes.
- When the ZyWALL starts up.
- 24-hour intervals after starting.

25.5.2 Time Server Synchronization

Click the **Synchronize Now** button to get the time and date from the predefined time server or the time server you specified in the **Time Server Address** field.

When the **System Time and Date Synchronization in Process** screen appears, wait up to one minute.

Figure 265 Synchronization in Process

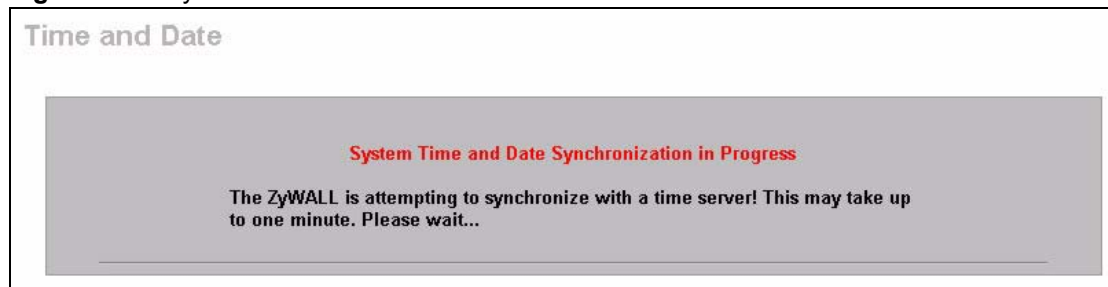

Click the **Return** button to go back to the **Time and Date** screen after the time and date is updated successfully.

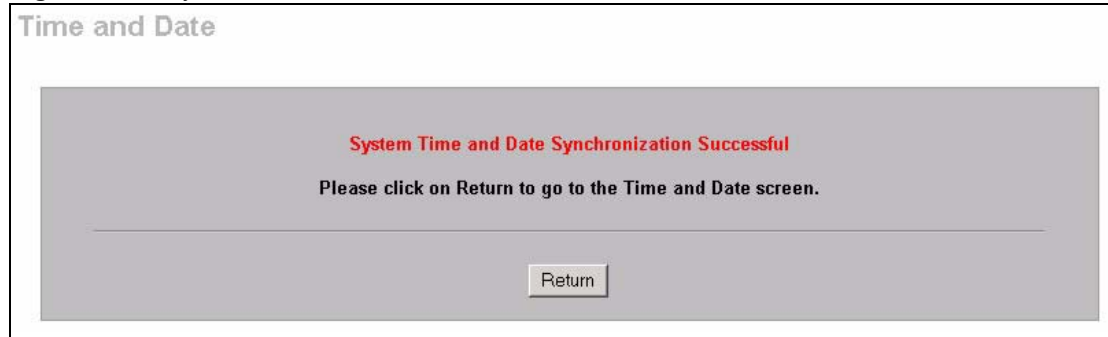
Figure 266 Synchronization is Successful

If the update was not successful, the following screen appears. Click **Return** to go back to the **Time and Date** screen.

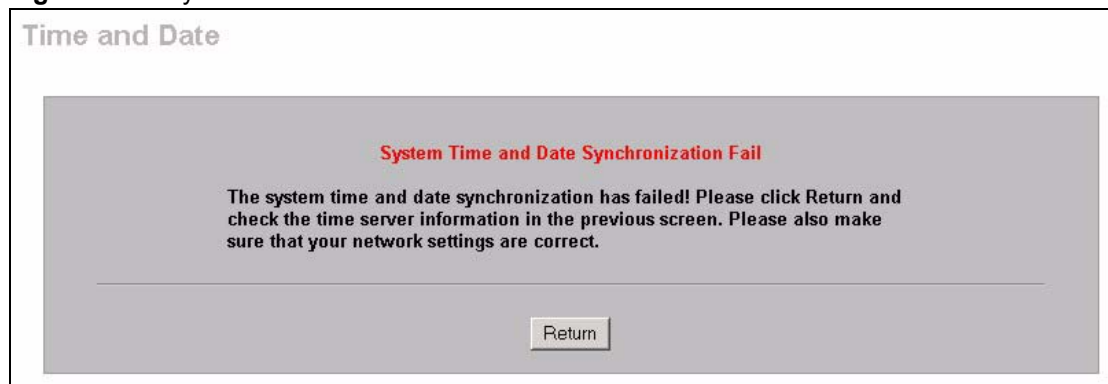
Figure 267 Synchronization Fail

25.6 Introduction To Transparent Bridging

A transparent bridge is invisible to the operation of a network in that it does not modify the frames it forwards. The bridge checks the source address of incoming frames on the port and learns MAC addresses to associate with that port. All future communications to that MAC address will only be sent on that port.

The bridge gradually builds a host MAC-address-to-port mapping table such as in the following example, during the learning process.

Table 154 MAC-address-to-port Mapping Table

HOST MAC ADDRESS	PORT
00a0c5123456	3
00a0c5123478 (host A)	1
00a0c512349a	3
00a0c51234bc	2
00a0c51234de	4

For example, if a bridge receives a frame via port 1 from host A (MAC address 00a0c5123478), the bridge associates host A with port 1. When the bridge receives another frame on one of its ports with destination address 00a0c5123478, it forwards the frame directly through port 1 after checking the internal table.

The bridge takes one of these actions after it checks the destination address of an incoming frame with its internal table:

- If the table contains an association between the destination address and any of the bridge's ports aside from the one on which the frame was received, the frame is forwarded out the associated port.
- If no association is found, the frame is flooded to all ports except the inbound port. Broadcasts and multicasts also are flooded in this way.
- If the associated port is the same as the incoming port, then the frame is dropped (filtered).

25.7 Transparent Firewalls

A transparent firewall (also known as a transparent, in-line, shadow, stealth or bridging firewall) has the following advantages over “router firewalls”:

- 1 The use of a bridging firewall reduces configuration and deployment time because no networking configuration changes to your existing network (hosts, neighboring routers and the firewall itself) are needed. Just put it in-line with the network it is protecting. As it only moves frames between ports (after inspecting them), it is completely transparent.
- 2 Performance is improved as there's less processing overhead.
- 3 As a transparent bridge does not modify the frames it forwards, it is effectively “stealth” as it is invisible to attackers.

Bridging devices are most useful in complex environments that require a rapid or new firewall deployment. A transparent, bridging firewall can also be good for companies with several branch offices since the setups at these offices are often the same and it's likely that one design can be used for many of the networks. A bridging firewall could be configured at HQ, sent to the branches and then installed directly without additional configuration.

25.8 Configuring Device Mode (Router)

Click **MAINTENANCE > Device Mode** to open the following screen. Use this screen to configure your ZyWALL as a router or a bridge.

In bridge mode, the ZyWALL functions as a transparent firewall (also known as a bridge firewall). The ZyWALL bridges traffic traveling between the ZyWALL's interfaces and still filters and inspects packets. You do not need to change the configuration of your existing network.

In bridge mode, the ZyWALL cannot get an IP address from a DHCP server. The LAN, WAN, DMZ and WLAN interfaces all have the same (static) IP address and subnet mask. You can configure the ZyWALL's IP address in order to access the ZyWALL for management. If you connect your computer directly to the ZyWALL, you also need to assign your computer a static IP address in the same subnet as the ZyWALL's IP address in order to access the ZyWALL.

You can use the firewall and VPN in bridge mode. The following applies when the ZyWALL is in router mode.

Figure 268 MAINTENANCE > Device Mode (Router Mode)

The screenshot shows the 'MAINTENANCE' page with the 'Device Mode' tab selected. Under 'Current Device Mode', it shows 'Device Mode: Router'. Under 'Device Mode Setup', there is a note: 'The ZyWALL restarts automatically after you change the device mode and click "Apply".' There are two radio buttons: 'Router' (unselected) and 'Bridge' (selected). Below the 'Bridge' radio button are three input fields: 'IP Address' (192 . 168 . 1 . 1), 'IP Subnet Mask' (255 . 255 . 255 . 0), and 'Gateway IP Address' (0 . 0 . 0 . 0). At the bottom are 'Apply' and 'Reset' buttons.

The following table describes the labels in this screen.

Table 155 MAINTENANCE > Device Mode (Router Mode)

LABEL	DESCRIPTION
Current Device Mode	
Device Mode	This displays whether the ZyWALL is functioning as a router or a bridge.
Device Mode Setup	
Router	When the ZyWALL is in router mode, there is no need to select or clear this radio button.
IP Address	Click LAN , WAN , DMZ or WLAN to go to the LAN , WAN , DMZ or WLAN screen where you can view and/or change the corresponding settings.
Bridge	Select this radio button and configure the following fields, then click Apply to set the ZyWALL to bridge mode.
IP Address	Enter the IP address of your ZyWALL in dotted decimal notation. Use an IP address in the same subnet as the network to which you connect the ZyWALL. Make sure the IP address does not conflict with any other device on the network.
IP Subnet Mask	Enter the IP subnet mask of the ZyWALL.
Gateway IP Address	Enter the gateway IP address.
Apply	Click Apply to save your changes back to the ZyWALL. After you click Apply , please wait for one minute and use the IP address you configured in the IP Address field to access the ZyWALL again.
Reset	Click Reset to begin configuring this screen afresh.

25.9 Configuring Device Mode (Bridge)

Click **MAINTENANCE > Device Mode** to open the following screen. Use this screen to configure your ZyWALL as a router or a bridge.

In bridge mode, the ZyWALL functions as a transparent firewall (also known as a bridge firewall). The ZyWALL bridges traffic traveling between the ZyWALL's interfaces and still filters and inspects packets. You do not need to change the configuration of your existing network.

In bridge mode, the ZyWALL cannot get an IP address from a DHCP server. The LAN, WAN, DMZ and WLAN interfaces all have the same (static) IP address and subnet mask. You can configure the ZyWALL's IP address in order to access the ZyWALL for management. If you connect your computer directly to the ZyWALL, you also need to assign your computer a static IP address in the same subnet as the ZyWALL's IP address in order to access the ZyWALL.

You can use the firewall and VPN in bridge mode.

Figure 269 MAINTENANCE > Device Mode (Bridge Mode)

The screenshot shows the 'MAINTENANCE' interface with several tabs: General, Password, Time and Date, Device Mode (selected), F/W Upload, Backup & Restore, and Restart. The 'Current Device Mode' section shows 'Device Mode' set to 'Bridge'. The 'Device Mode Setup' section includes a note: 'The ZyWALL restarts automatically after you change the device mode and click "Apply"'. There are two radio buttons: 'Router' (unselected) and 'Bridge' (selected). Under 'Router', there are fields for 'LAN Interface IP Address' (192.168.1.1), 'LAN Interface Subnet Mask' (255.255.255.0), a checked 'DHCP' box, 'IP Pool Starting Address' (192.168.1.33), and 'Pool Size' (128). Under 'Bridge', there is an 'IP Address' field with a link to 'BRIDGE'. At the bottom are 'Apply' and 'Reset' buttons.

The following table describes the labels in this screen.

Table 156 MAINTENANCE > Device Mode (Bridge Mode)

LABEL	DESCRIPTION
Current Device Mode	
Device Mode	This displays whether the ZyWALL is functioning as a router or a bridge.
Device Mode Setup	
Router	Select this radio button and click Apply to set the ZyWALL to router mode.
LAN Interface IP Address	Enter the IP address of your ZyWALL's LAN port in dotted decimal notation. 192.168.1.1 is the factory default.
LAN Interface Subnet Mask	Enter the IP subnet mask of the ZyWALL's LAN port.

Table 156 MAINTENANCE > Device Mode (Bridge Mode) (continued)

LABEL	DESCRIPTION
DHCP	DHCP (Dynamic Host Configuration Protocol, RFC 2131 and RFC 2132) allows individual clients (computers) to obtain TCP/IP configuration at startup from a server. Unless you are instructed by your ISP, leave the DHCP check box selected. Clear it to stop the ZyWALL from acting as a DHCP server. When configured as a server, the ZyWALL provides TCP/IP configuration for the clients. If not, DHCP service is disabled and you must have another DHCP server on your LAN, or else the computers must be manually configured. When set as a server, fill in the rest of the DHCP setup fields.
IP Pool Starting Address	This field specifies the first of the contiguous addresses in the IP address pool.
Pool Size	This field specifies the size, or count of the IP address pool.
Bridge	When the ZyWALL is in bridge mode, there is no need to select or clear this radio button.
IP Address	Click Bridge to go to the Bridge screen where you can view and/or change the bridge settings.
Apply	Click Apply to save your changes back to the ZyWALL. After you click Apply , please wait for one minute and use the IP address you configured in the LAN Interface IP Address field to access the ZyWALL again.
Reset	Click Reset to begin configuring this screen afresh.

25.10 F/W Upload Screen

Find firmware at www.zyxel.com in a file that (usually) uses the system model name with a .bin extension, for example, "zywall.bin". The upload process uses HTTP (Hypertext Transfer Protocol) and may take up to two minutes. After a successful upload, the system will reboot. See [Section 39.5 on page 551](#) for upgrading firmware using FTP/TFTP commands.

Click **MAINTENANCE > F/W UPLOAD**. Follow the instructions in this screen to upload firmware to your ZyWALL.



Only upload firmware for your specific model!

Figure 270 MAINTENANCE > Firmware Upload

MAINTENANCE

General Password Time and Date Device Mode **F/W Upload** Backup & Restore Restart

Firmware Upload

To upgrade the internal router firmware, browse to the location of the binary (.BIN) upgrade file and click Upload. Upgrade files can be downloaded from website. If the upgrade file is compressed (.ZIP file), you must first extract the binary (.BIN) file. In some cases, you may need to reconfigure the router after upgrading.

File Path:

The following table describes the labels in this screen.

Table 157 MAINTENANCE > Firmware Upload

LABEL	DESCRIPTION
File Path	Type in the location of the file you want to upload in this field or click Browse ... to find it.
Browse...	Click Browse... to find the .bin file you want to upload. Remember that you must decompress compressed (.zip) files before you can upload them.
Upload	Click Upload to begin the upload process. This process may take up to two minutes.



Do not turn off the ZyWALL while firmware upload is in progress!

After you see the **Firmware Upload in Process** screen, wait two minutes before logging into the ZyWALL again.

Figure 271 Firmware Upload In Process

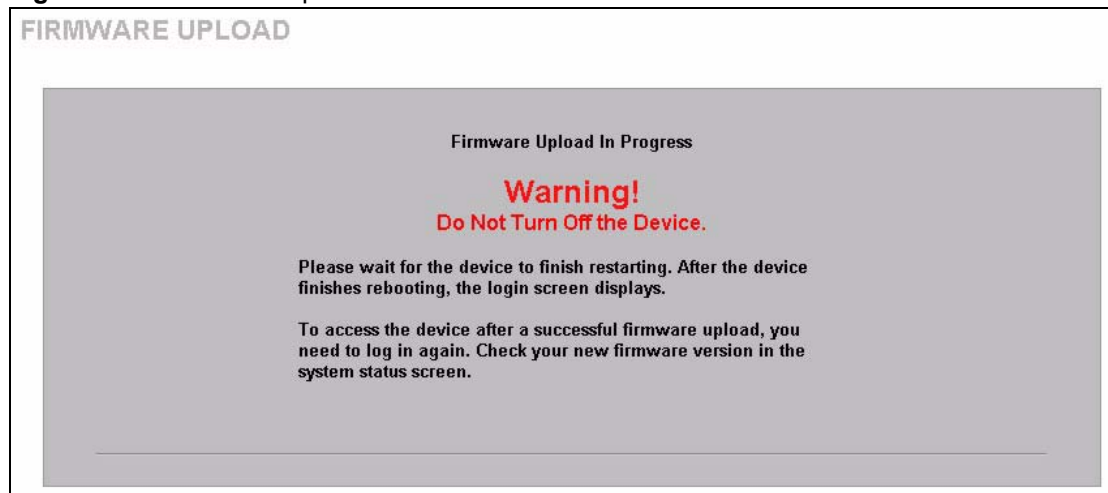

The ZyWALL automatically restarts in this time causing a temporary network disconnect. In some operating systems, you may see the following icon on your desktop.

Figure 272 Network Temporarily Disconnected



After two minutes, log in again and check your new firmware version in the **HOME** screen.

If the upload was not successful, the following screen will appear. Click **Return** to go back to the **F/W Upload** screen.

Figure 273 Firmware Upload Error

25.11 Backup and Restore

See [Section 39.5 on page 551](#) for transferring configuration files using FTP/TFTP commands.

Click **MAINTENANCE > Backup & Restore**. Information related to factory defaults, backup configuration, and restoring configuration appears as shown next.

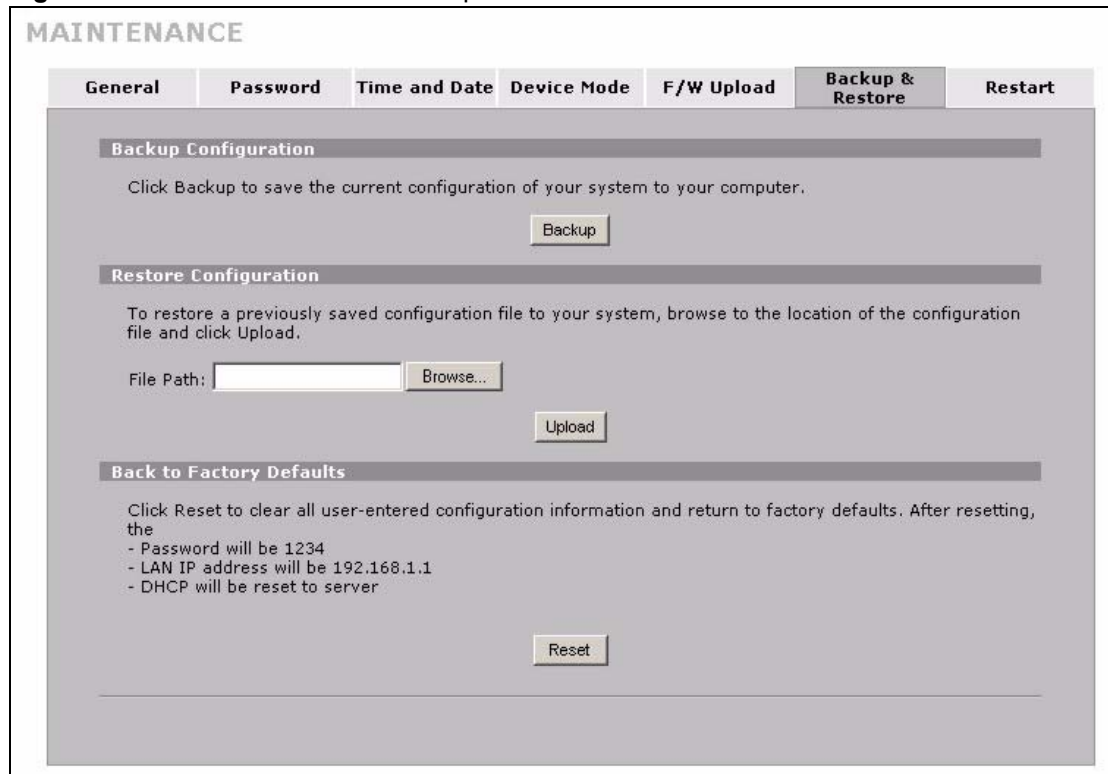
Figure 274 MAINTENANCE > Backup and Restore

25.11.1 Backup Configuration

Backup configuration allows you to back up (save) the ZyWALL's current configuration to a file on your computer. Once your ZyWALL is configured and functioning properly, it is highly recommended that you back up your configuration file before making configuration changes. The backup configuration file will be useful in case you need to return to your previous settings.

Click **Backup** to save the ZyWALL's current configuration to your computer.

25.11.2 Restore Configuration

Load a configuration file from your computer to your ZyWALL.

Table 158 Restore Configuration

LABEL	DESCRIPTION
File Path	Type in the location of the file you want to upload in this field or click Browse ... to find it.
Browse...	Click Browse... to find the file you want to upload. Remember that you must decompress compressed (.ZIP) files before you can upload them.
Upload	Click Upload to begin the upload process.



Do not turn off the ZyWALL while configuration file upload is in progress.

After you see a “restore configuration successful” screen, you must then wait one minute before logging into the ZyWALL again.

Figure 275 Configuration Upload Successful



The ZyWALL automatically restarts in this time causing a temporary network disconnect. In some operating systems, you may see the following icon on your desktop.

Figure 276 Network Temporarily Disconnected



If you uploaded the default configuration file you may need to change the IP address of your computer to be in the same subnet as that of the default device IP address (192.168.1.1). See your Quick Start Guide for details on how to set up your computer's IP address.

If the upload was not successful, the following screen will appear. Click **Return** to go back to the **Configuration** screen.

Figure 277 Configuration Upload Error

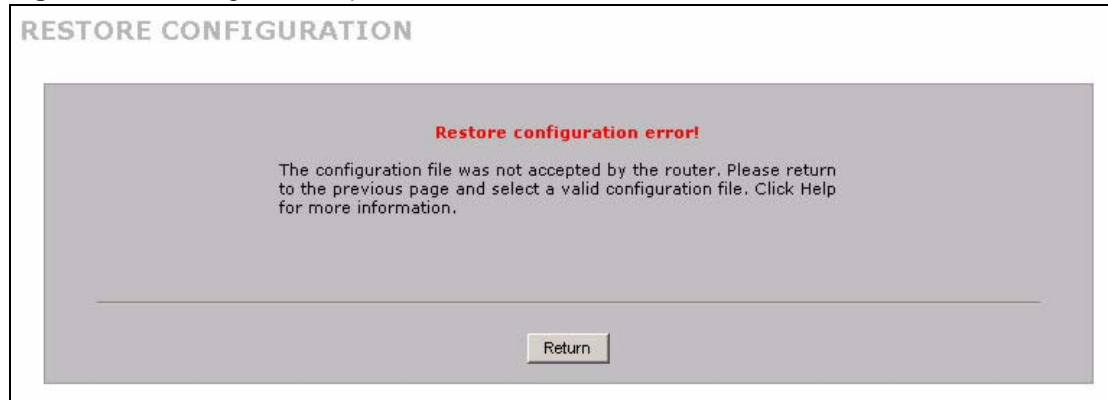

25.11.3 Back to Factory Defaults

Click the **Reset** button to clear all user-entered configuration information and return the ZyWALL to its factory defaults as shown on the screen. The following warning screen appears.

Figure 278 Reset Warning Message

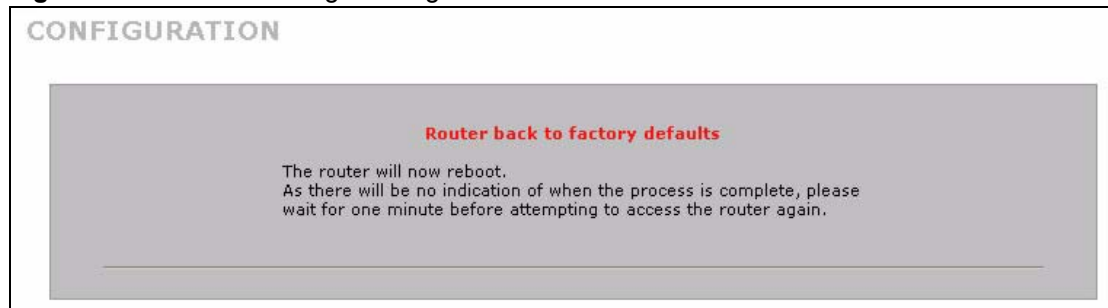

You can also press the hardware **RESET** button to reset the factory defaults of your ZyWALL. Refer to [Section 2.3 on page 51](#) for more information on the **RESET** button.

25.12 Restart Screen

System restart allows you to reboot the ZyWALL without turning the power off.

Click **MAINTENANCE > Restart**. Click **Restart** to have the ZyWALL reboot. Restart is different to reset; (see [Section 25.11.3 on page 437](#)) reset returns the device to its default configuration.

Figure 279 MAINTENANCE > Restart



PART VI

SMT and

Troubleshooting

Introducing the SMT (441)
SMT Menu 1 - General Setup (449)
WAN and Dial Backup Setup (455)
LAN Setup (467)
Internet Access (473)
DMZ Setup (477)
Remote Node Setup (481)
IP Static Route Setup (491)
Network Address Translation (NAT) (493)
Introducing the ZyWALL Firewall (511)
Filter Configuration (513)
SNMP Configuration (529)
System Information & Diagnosis (531)
Firmware and Configuration File Maintenance (543)
System Maintenance Menus 8 to 10 (557)
Remote Management (565)
Call Scheduling (569)
Troubleshooting (573)

Introducing the SMT

This chapter explains how to access the System Management Terminal and gives an overview of its menus.

26.1 Introduction to the SMT

The ZyWALL's SMT (System Management Terminal) is a menu-driven interface that you can access from a terminal emulator through the console port or over a telnet connection. This chapter shows you how to access the SMT (System Management Terminal) menus via console port, how to navigate the SMT and how to configure SMT menus.

26.2 Accessing the SMT via the Console Port

Make sure you have the physical connection properly set up as described in the Quick Start Guide.

When configuring using the console port, you need a computer equipped with communications software configured to the following parameters:

- VT100 terminal emulation.
- 9600 Baud.
- No parity, 8 data bits, 1 stop bit, flow control set to none.

26.2.1 Initial Screen

When you turn on your ZyWALL, it performs several internal tests as well as line initialization.

After the tests, the ZyWALL asks you to press [ENTER] to continue, as shown next.

Figure 280 Initial Screen

```

Copyright (c) 1994 - 2006 ZyXEL Communications Corp.

initialize ch =0, ethernet address: 00:A0:C5:01:23:45
initialize ch =1, ethernet address: 00:A0:C5:01:23:46
initialize ch =2, ethernet address: 00:A0:C5:01:23:47
initialize ch =3, ethernet address: 00:A0:C5:01:23:48
initialize ch =4, ethernet address: 00:00:00:00:00:00
AUX port init . done
Modem init . inactive

Press ENTER to continue...

```

26.2.2 Entering the Password

The login screen appears after you press [ENTER], prompting you to enter the password, as shown below.

For your first login, enter the default password “1234”. As you type the password, the screen displays an “X” for each character you type.

Please note that if there is no activity for longer than five minutes after you log in, your ZyWALL will automatically log you out and display a blank screen. If you see a blank screen, press [ENTER] to bring up the login screen again.

Figure 281 Password Screen

```

Enter Password : XXXX

```

26.3 Navigating the SMT Interface

The SMT is an interface that you use to configure your ZyWALL.

Several operations that you should be familiar with before you attempt to modify the configuration are listed in the table below.

Table 159 Main Menu Commands

OPERATION	KEYSTROKES	DESCRIPTION
Move down to another menu	[ENTER]	To move forward to a submenu, type in the number of the desired submenu and press [ENTER].
Move up to a previous menu	[ESC]	Press the [ESC] key to move back to the previous menu.
Move to a “hidden” menu	Press [SPACE BAR] to change No to Yes then press [ENTER].	Fields beginning with “Edit” lead to hidden menus and have a default setting of No. Press [SPACE BAR] to change No to Yes, and then press [ENTER] to go to a “hidden” menu.

Table 159 Main Menu Commands

OPERATION	KEYSTROKES	DESCRIPTION
Move the cursor	[ENTER] or [UP]/ [DOWN] arrow keys	Within a menu, press [ENTER] to move to the next field. You can also use the [UP]/[DOWN] arrow keys to move to the previous and the next field, respectively. When you are at the top of a menu, press the [UP] arrow key to move to the bottom of a menu.
Entering information	Fill in, or press [SPACE BAR], then press [ENTER] to select from choices.	You need to fill in two types of fields. The first requires you to type in the appropriate information. The second allows you to cycle through the available choices by pressing [SPACE BAR].
Required fields	<? >	All fields with the symbol <?> must be filled in order be able to save the new configuration.
N/A fields	<N/A>	Some of the fields in the SMT will show a <N/A>. This symbol refers to an option that is Not Applicable.
Save your configuration	[ENTER]	Save your configuration by pressing [ENTER] at the message "Press ENTER to confirm or ESC to cancel". Saving the data on the screen will take you, in most cases to the previous menu. Make sure you save your settings in each screen that you configure.
Exit the SMT	Type 99, then press [ENTER].	Type 99 at the main menu prompt and press [ENTER] to exit the SMT interface.

26.3.1 Main Menu

After you enter the password, the SMT displays the **ZyWALL Main Menu**, as shown next.

Figure 282 Main Menu (Router Mode)

```

Copyright (c) 1994 - 2006 ZyXEL Communications Corp.

ZyWALL 2 Plus Main Menu

Getting Started
  1. General Setup
  2. WAN Setup
  3. LAN Setup
  4. Internet Access Setup
  5. DMZ Setup

Advanced Applications
  11. Remote Node Setup
  12. Static Routing Setup
  15. NAT Setup

Advanced Management
  21. Filter and Firewall Setup
  22. SNMP Configuration
  23. System Password
  24. System Maintenance
  26. Schedule Setup

99. Exit

Enter Menu Selection Number:

```

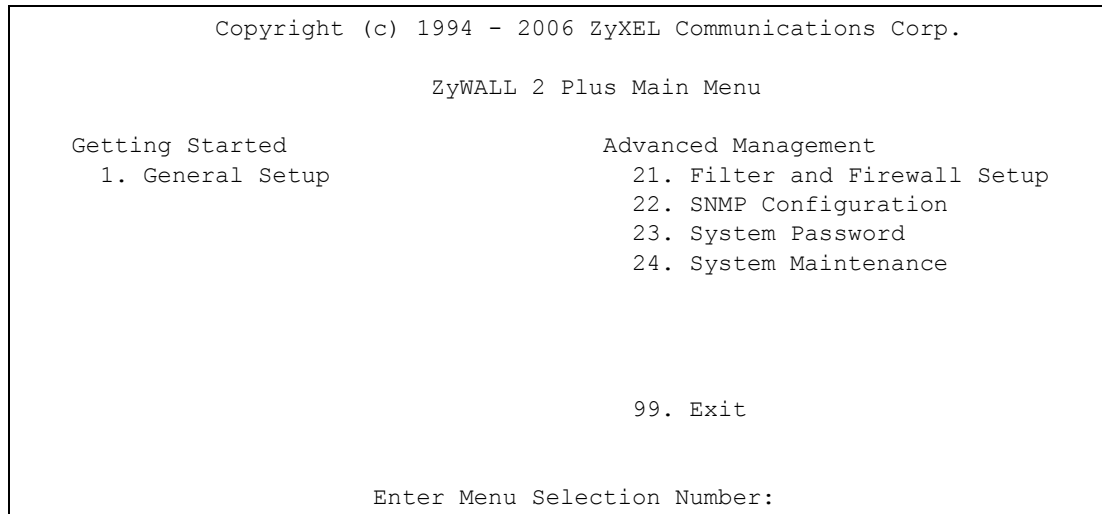
Figure 283 Main Menu (Bridge Mode)

The following table describes the fields in this menu.

Table 160 Main Menu Summary

NO	MENU TITLE	FUNCTION
1	General Setup	Use this menu to set up device mode, dynamic DNS and administrative information.
2	WAN Setup	Use this menu to clone a MAC address from a computer on your LAN and configure the backup WAN dial-up connection.
3	LAN Setup	Use this menu to apply LAN filters, configure LAN DHCP and TCP/IP settings.
4	Internet Access Setup	Configure your Internet access setup (Internet address, gateway, login, etc.) with this menu.
5	DMZ Setup	Use this menu to apply DMZ filters, and configure DHCP and TCP/IP settings for the DMZ port.
11	Remote Node Setup	Use this menu to configure detailed remote node settings (your ISP is also a remote node) as well as apply WAN filters.
12	Static Routing Setup	Configure IP static routes in this menu.
15	NAT Setup	Use this menu to configure Network Address Translation.
21	Filter and Firewall Setup	Configure filters and activate/deactivate the firewall.
22	SNMP Configuration	Use this menu to configure SNMP-related parameters.
23	System Password	Change your password in this menu (recommended).
24	System Maintenance	From displaying system status to uploading firmware, this menu provides comprehensive system maintenance.
26	Schedule Setup	Use this menu to schedule outgoing calls.
99	Exit	Use this menu to exit (necessary for remote configuration).

26.3.2 SMT Menu Overview

The following table gives you an overview of your ZyWALL's various SMT menus.

Table 161 SMT Menu Overview

MENUS	SUB MENUS			
1 General Setup	1.1 Configure Dynamic DNS	1.1.1 DDNS Host Summary	1.1.1 DDNS Edit Host	
2 WAN Setup	2.1 Advanced WAN Setup			
3 LAN Setup	3.1 LAN Port Filter Setup			
	3.2 TCP/IP and DHCP Ethernet Setup	3.2.1 IP Alias Setup		
4 Internet Access Setup				
5 DMZ Setup	5.1 DMZ Port Filter Setup			
	5.2 TCP/IP and DHCP Ethernet Setup	5.2.1 IP Alias Setup		
11 Remote Node Setup	11.1 Remote Node Profile	11.1.2 Remote Node Network Layer Options		
		11.1.4 Remote Node Filter		
		11.1.5 Traffic Redirect Setup		
	11.2 Remote Node Profile (Backup ISP)	11.2.1 Remote Node PPP Options		
		11.2.2 Remote Node Network Layer Options		
		11.2.3 Remote Node Script		
11.2.4 Remote Node Filter				
12 Static Routing Setup	12.1 Edit IP Static Route			
15 NAT Setup	15.1 Address Mapping Sets	15.1.x Address Mapping Rules	15.1.x.x Address Mapping Rule	
	15.2 Port Forwarding Setup	15.2.x NAT Server Setup	15.2.x.x - NAT Server Configuration	
	15.3 Trigger Port Setup			
21 Filter and Firewall Setup	21.1 Filter Setup	21.1.x Filter Rules Summary	21.1.x.x Generic Filter Rule	
			21.1.x.x TCP/IP Filter Rule	
	21.2 Firewall Setup			
22 SNMP Configuration				
23 System Password				

Table 161 SMT Menus Overview (continued)

MENUS	SUB MENUS		
24 System Maintenance	24.1 System Status		
	24.2 System Information and Console Port Speed	24.2.1 System Information	
		24.2.2 Console Port Speed	
	24.3 Log and Trace	24.3.1 View Error Log	
		24.3.2 Syslog Logging	
		24.3.4 Call-Triggering Packet	
	24.4 Diagnostic		
	24.5 Backup Configuration		
	24.6 Restore Configuration		
	24.7 Upload Firmware	24.7.1 Upload System Firmware	
		24.7.2 Upload System Configuration File	
	24.8 Command Interpreter Mode		
	24.9 Call Control	24.9.1 Budget Management	
24.9.2 Call History			
24.10 Time and Date Setting			
24.11 Remote Management Setup			
26 Schedule Setup	26.1 Schedule Set Setup		

26.4 Changing the System Password

Change the system password by following the steps shown next.

- 1 Enter 23 in the main menu to open **Menu 23 - System Password** as shown next.

Figure 284 Menu 23: System Password

```

Menu 23 - System Password

Old Password= ?
New Password= ?
Retype to confirm= ?

Enter here to CONFIRM or ESC to CANCEL:

```

- 2 Type your existing password and press [ENTER].
- 3 Type your new system password and press [ENTER].
- 4 Re-type your new system password for confirmation and press [ENTER].

Note that as you type a password, the screen displays an “x” for each character you type.

26.5 Resetting the ZyWALL

See [Section 2.3 on page 51](#) for directions on resetting the ZyWALL.

SMT Menu 1 - General Setup

Menu 1 - General Setup contains administrative and system-related information.

27.1 Introduction to General Setup

Menu 1 - General Setup contains administrative and system-related information.

27.2 Configuring General Setup

- 1 Enter 1 in the main menu to open **Menu 1 - General Setup**.
- 2 The **Menu 1 - General Setup** screen appears, as shown next. Fill in the required fields.

Figure 285 Menu 1: General Setup (Router Mode)

```

Menu 1 - General Setup

System Name=
Domain Name=

Device Mode= Router Mode

Edit Dynamic DNS= No

Press ENTER to Confirm or ESC to Cancel:

```

The following table describes the fields in this menu.

Table 162 Menu 1: General Setup (Router Mode)

FIELD	DESCRIPTION
System Name	Choose a descriptive name for identification purposes. It is recommended you enter your computer's "Computer name" in this field. This name can be up to 30 alphanumeric characters long. Spaces are not allowed, but dashes "-" and underscores "_" are accepted.
Domain Name	Enter the domain name (if you know it) here. If you leave this field blank, the ISP may assign a domain name via DHCP. You can go to menu 24.8 and type "sys domain name" to see the current domain name used by your router. The domain name entered by you is given priority over the ISP assigned domain name. If you want to clear this field just press [SPACE BAR] and then [ENTER].

Table 162 Menu 1: General Setup (Router Mode) (continued)

FIELD	DESCRIPTION
Device Mode	Press [SPACE BAR] and then [ENTER] to select Router Mode .
Edit Dynamic DNS	Press [SPACE BAR] and then [ENTER] to select Yes or No (default). Select Yes to configure Menu 1.1: Configure Dynamic DNS discussed next.
When you have completed this menu, press [ENTER] at the prompt "Press ENTER to Confirm..." to save your configuration, or press [ESC] at any time to cancel.	

Figure 286 Menu 1: General Setup (Bridge Mode)

```

Menu 1 - General Setup

System Name=
Domain Name=

Device Mode= Bridge Mode

IP Address= 192.168.1.1
Network Mask= 255.255.255.0
Gateway= 0.0.0.0
First System DNS Server
  IP Address= 0.0.0.0
Second System DNS Server
  IP Address= 0.0.0.0
Third System DNS Server
  IP Address= 0.0.0.0

Press ENTER to Confirm or ESC to Cancel:

```

The following table describes the fields not previously discussed (see [Table 162 on page 449](#)).

Table 163 Menu 1: General Setup (Bridge Mode)

FIELD	DESCRIPTION
Device Mode	Press [SPACE BAR] and then [ENTER] to select Bridge Mode .
IP Address	Enter the IP address of your ZyWALL in dotted decimal notation.
Network Mask	Enter the subnet mask of your ZyWALL.
Gateway	Enter the gateway IP address.
First System DNS Server Second System DNS Server Third System DNS Server	Enter the DNS server's IP address(es) in the IP Address field(s) if you have the IP address(es) of the DNS server(s).

27.2.1 Configuring Dynamic DNS

To configure Dynamic DNS, set the ZyWALL to router mode in menu 1 or in the **MAINTENANCE Device Mode** screen and go to **Menu 1 - General Setup** and press [SPACE BAR] to select **Yes** in the **Edit Dynamic DNS** field. Press [ENTER] to display **Menu 1.1 - Configure Dynamic DNS** (shown next).

Figure 287 Menu 1.1: Configure Dynamic DNS

```

Menu 1.1 - Configure Dynamic DNS

Service Provider= WWW.DynDNS.ORG
Active= No
Username=
Password= *****
Edit Host= No

Press ENTER to Confirm or ESC to Cancel:

```

Follow the instructions in the next table to configure Dynamic DNS parameters.

Table 164 Menu 1.1: Configure Dynamic DNS

FIELD	DESCRIPTION
Service Provider	This is the name of your Dynamic DNS service provider.
Active	Press [SPACE BAR] to select Yes and then press [ENTER] to make dynamic DNS active.
Username	Enter your user name.
Password	Enter the password assigned to you.
Edit Host	Press [SPACE BAR] and then [ENTER] to select Yes if you want to configure a DDNS host.
When you have completed this menu, press [ENTER] at the prompt "Press ENTER to Confirm..." to save your configuration, or press [ESC] at any time to cancel.	

27.2.1.1 Editing DDNS Host

To configure a DDNS host, follow the procedure below.

- 1 Configure your ZyWALL as a router in menu 1 or the **MAINTENANCE Device Mode** screen.
- 2 Enter 1 in the main menu to open **Menu 1 - General Setup**.
- 3 Press [SPACE BAR] to select **Yes** in the **Edit Dynamic DNS** field. Press [ENTER] to display **Menu 1.1 - Configure Dynamic DNS**.
- 4 Press [SPACE BAR] and then [ENTER] to select **Yes** in the **Edit Host** field. Press [ENTER] to display **Menu 1.1.1 - DDNS Host Summary**.

Figure 288 Menu 1.1.1: DDNS Host Summary

```

Menu 1.1.1 DDNS Host Summary

#          Summary
-----
01  Hostname=ZyWALL,
    Type=Dynamic,WC=Yes,Offline=No,Policy=DDNS Server
    Detect, WAN1, HA=Yes
02  _____
03  _____
04  _____
05  _____

Select Command= None          Select Rule= N/A
Press ENTER to Confirm or ESC to Cancel:

```

The following table describes the fields in this screen.

Table 165 Menu 1.1.1: DDNS Host Summary

FIELD	DESCRIPTION
#	This is the DDNS host index number.
Summary	This displays the details about the DDNS host.
Select Command	Press [SPACE BAR] to choose from None , Edit , Delete , Next Page or Previous Page and then press [ENTER]. You must select a DDNS host in the next field when you choose the Edit or Delete commands. Select None and then press [ENTER] to go to the "Press ENTER to Confirm..." prompt. Use Edit to create or edit a rule. Use Delete to remove a rule. To edit or delete a DDNS host, first make sure you are on the correct page. When a rule is deleted, subsequent rules do not move up in the page list. Select Next Page or Previous Page to view the next or previous page of DDNS hosts (respectively).
Select Rule	Type the DDNS host index number you wish to edit or delete and then press [ENTER].
When you have completed this menu, press [ENTER] at the prompt "Press ENTER to Confirm..." to save your configuration, or press [ESC] at any time to cancel.	

- 5 Select **Edit** in the **Select Command** field; type the index number of the DDNS host you want to configure in the **Select Rule** field and press [ENTER] to open **Menu 1.1.1 - DDNS Edit Host** (see the next figure).

Figure 289 Menu 1.1.1: DDNS Edit Host

```

Menu 1.1.1 - DDNS Edit Host

Hostname= ZyWALL
DDNS Type= DynamicDNS
Enable Wildcard Option= Yes
Enable Off Line Option= N/A
IP Address Update Policy:
  Let DDNS Server Auto Detect= Yes
  Use User-Defined= N/A
  Use WAN IP Address= N/A

Press ENTER to Confirm or ESC to Cancel:

```

The following table describes the fields in this screen.

Table 166 Menu 1.1.1: DDNS Edit Host

FIELD	DESCRIPTION
Host Name	Enter your host name in this field.
DDNS Type	Press [SPACE BAR] and then [ENTER] to select DynamicDNS if you have the Dynamic DNS service. Select StaticDNS if you have the Static DNS service. Select CustomDNS if you have the Custom DNS service.
Enable Wildcard Option	Your ZyWALL supports DYNDNS Wildcard. Press [SPACE BAR] and then [ENTER] to select Yes or No . This field is N/A when you choose DDNS client as your service provider.
Enable Off Line Option	This field is only available when CustomDNS is selected in the DDNS Type field. Press [SPACE BAR] and then [ENTER] to select Yes . When Yes is selected, http://www.dyndns.org/ traffic is redirected to a URL that you have previously specified (see www.dyndns.org for details).
IP Address Update Policy:	You can select Yes in either the Let DDNS Server Auto Detect field (recommended) or the Use User-Defined field, but not both. With the Let DDNS Server Auto Detect and Use User-Defined fields both set to No , the DDNS server automatically updates the IP address of the host name(s) with the ZyWALL's WAN IP address. DDNS does not work with a private IP address. When both fields are set to No , the ZyWALL must have a public WAN IP address in order for DDNS to work.
Let DDNS Server Auto Detect	Only select this option when there are one or more NAT routers between the ZyWALL and the DDNS server. Press [SPACE BAR] to select Yes and then press [ENTER] to have the DDNS server automatically detect and use the IP address of the NAT router that has a public IP address. Note: The DDNS server may not be able to detect the proper IP address if there is an HTTP proxy server between the ZyWALL and the DDNS server.
Use User-Defined	Press [SPACE BAR] to select Yes and then press [ENTER] to update the IP address of the host name(s) to the IP address specified below. Only select Yes if the ZyWALL uses or is behind a static public IP address.

Table 166 Menu 1.1.1: DDNS Edit Host (continued)

FIELD	DESCRIPTION
Use WAN IP Address	Enter the static public IP address if you select Yes in the Use User-Defined field.
When you have completed this menu, press [ENTER] at the prompt "Press ENTER to Confirm..." to save your configuration, or press [ESC] at any time to cancel.	

The IP address updates when you reconfigure menu 1 or perform DHCP client renewal.

WAN and Dial Backup Setup

This chapter describes how to configure the WAN using menu 2 and dial-backup using menus 2.1 and 11.1.

28.1 Introduction to WAN and Dial Backup Setup

This chapter explains how to configure settings for your WAN port and how to configure the ZyWALL for a dial backup connection.

28.2 WAN Setup

From the main menu, enter 2 to open menu 2.

Figure 290 MAC Address Cloning in WAN Setup

```
Menu 2 - WAN Setup

MAC Address:
Assigned By= Factory default
IP Address= N/A

Dial-Backup:
Active= No

Port Speed= 115200
AT Command String:
Init= at&fs0=0
Edit Advanced Setup= No

Press ENTER to Confirm or ESC to Cancel:
```

The following table describes the fields in this screen.

Table 167 MAC Address Cloning in WAN Setup

FIELD	DESCRIPTION
MAC Address	
Assigned By	Press [SPACE BAR] and then [ENTER] to choose one of two methods to assign a MAC Address. Choose Factory Default to select the factory assigned default MAC Address. Choose IP address attached on LAN to use the MAC Address of that computer whose IP you give in the following field.
IP Address	This field is applicable only if you choose the IP address attached on LAN method in the Assigned By field. Enter the IP address of the computer on the LAN whose MAC you are cloning.
When you have completed this menu, press [ENTER] at the prompt "Press ENTER to Confirm..." to save your configuration, or press [ESC] at any time to cancel.	

28.3 Dial Backup

The Dial Backup port can be used in reserve, as a traditional dial-up connection should the broadband connection to the WAN port fail. To set up the auxiliary port (Dial Backup) for use in the event that the regular WAN connection is dropped, first make sure you have set up the switch and port connection (see the Quick Start Guide), then configure

- 1 Menu 2 - WAN Setup,
- 2 Menu 2.1 - Advanced WAN Setup and
- 3 Menu 11.2 - Remote Node Profile (Backup ISP) as shown next

Refer also to the section about traffic redirect for information on an alternate backup WAN connection.

28.4 Configuring Dial Backup in Menu 2

From the main menu, enter 2 to open menu 2.

Figure 291 Menu 2: Dial Backup Setup

```

Menu 2 - WAN Setup

MAC Address:
Assigned By= Factory default
IP Address= N/A

Dial-Backup:
Active= No

Port Speed= 115200
AT Command String:
Init= at&fs0=0
Edit Advanced Setup= No

Press ENTER to Confirm or ESC to Cancel:

```

The following table describes the fields in this menu.

Table 168 Menu 2: Dial Backup Setup

FIELD	DESCRIPTION
Dial-Backup:	
Active	Use this field to turn the dial-backup feature on (Yes) or off (No).
Port Speed	Press [SPACE BAR] and then press [ENTER] to select the speed of the connection between the Dial Backup port and the external device. Available speeds are: 9600, 19200, 38400, 57600, 115200 or 230400 bps.
AT Command String:	
Init	Enter the AT command string to initialize the WAN device. Consult the manual of your WAN device connected to your Dial Backup port for specific AT commands.
Edit Advanced Setup	To edit the advanced setup for the Dial Backup port, move the cursor to this field; press the [SPACE BAR] to select Yes and then press [ENTER] to go to Menu 2.1 - Advanced Setup .
When you have completed this menu, press [ENTER] at the prompt "Press ENTER to Confirm..." to save your configuration, or press [ESC] at any time to cancel.	

28.5 Advanced WAN Setup



Consult the manual of your WAN device connected to your Dial Backup port for specific AT commands.

To edit the advanced setup for the Dial Backup port, move the cursor to the **Edit Advanced Setup** field in **Menu 2 - WAN Setup**, press the [SPACE BAR] to select **Yes** and then press [ENTER].

Figure 292 Menu 2.1: Advanced WAN Setup

```

Menu 2.1 - Advanced WAN Setup

AT Command Strings:
Dial= atdt
Drop= ~~~+++~~ath
Answer= ata

Drop DTR When Hang Up= Yes

AT Response Strings:
CLID= NMBR =
Called Id=
Speed= CONNECT

Call Control:
Dial Timeout(sec)= 60
Retry Count= 0
Retry Interval(sec)= N/A
Drop Timeout(sec)= 20
Call Back Delay(sec)= 15

Press ENTER to Confirm or ESC to Cancel:

```

The following table describes fields in this menu.

Table 169 Advanced WAN Port Setup: AT Commands Fields

FIELD	DESCRIPTION
AT Command Strings:	
Dial	Enter the AT Command string to make a call.
Drop	Enter the AT Command string to drop a call. “~” represents a one second wait, e.g., “~~~~+++~~ath” can be used if your modem has a slow response time.
Answer	Enter the AT Command string to answer a call.
Drop DTR When Hang Up	Press the [SPACE BAR] to choose either Yes or No . When Yes is selected (the default), the DTR (Data Terminal Ready) signal is dropped after the “AT Command String: Drop” is sent out.
AT Response Strings:	
CLID (Calling Line Identification)	Enter the keyword that precedes the CLID (Calling Line Identification) in the AT response string. This lets the ZyWALL capture the CLID in the AT response string that comes from the WAN device. CLID is required for CLID authentication.
Called Id	Enter the keyword preceding the dialed number.
Speed	Enter the keyword preceding the connection speed.

Table 170 Advanced WAN Port Setup: Call Control Parameters

FIELD	DESCRIPTION
Call Control	
Dial Timeout (sec)	Enter a number of seconds for the ZyWALL to keep trying to set up an outgoing call before timing out (stopping). The ZyWALL times out and stops if it cannot set up an outgoing call within the timeout value.
Retry Count	Enter a number of times for the ZyWALL to retry a busy or no-answer phone number before blacklisting the number.
Retry Interval (sec)	Enter a number of seconds for the ZyWALL to wait before trying another call after a call has failed. This applies before a phone number is blacklisted.
Drop Timeout (sec)	Enter a number of seconds for the ZyWALL to wait before dropping the DTR signal if it does not receive a positive disconnect confirmation.
Call Back Delay (sec)	Enter a number of seconds for the ZyWALL to wait between dropping a callback request call and dialing the co-responding callback call.

28.6 Remote Node Profile (Backup ISP)

On the ZyWALL, enter **2** in **Menu 11 - Remote Node Setup** to open **Menu 11.2 - Remote Node Profile (Backup ISP)** and configure the setup for your Dial Backup port connection.

Figure 293 Menu 11.2: Remote Node Profile (Backup ISP)

```

Menu 11.3 - Remote Node Profile (Backup ISP)

Rem Node Name=                               Edit PPP Options= No
Active= No                                     Edit IP= No
                                                Edit Script Options= No

Outgoing:
  My Login= ChangeMe
  My Password= *****
  Retype to Confirm= *****
  Authen= CHAP/PAP
  Pri Phone #= 0
  Sec Phone #=

Telco Option:
  Allocated Budget(min)= 0
  Period(hr)= 0
  Schedules=
  Always On= No

Session Options:
  Edit Filter Sets= No
  Idle Timeout(sec)= 100

Press ENTER to Confirm or ESC to Cancel:

```

The following table describes the fields in this menu.

Table 171 Menu 11.3: Remote Node Profile (Backup ISP)

FIELD	DESCRIPTION
Rem Node Name	Enter a descriptive name for the remote node. This field can be up to eight characters.
Active	Press [SPACE BAR] and then [ENTER] to select Yes to enable the remote node or No to disable the remote node.
Outgoing	
My Login	Enter the login name assigned by your ISP for this remote node.
My Password	Enter the password assigned by your ISP for this remote node.
Retype to Confirm	Enter your password again to make sure that you have entered is correctly.
Authen	This field sets the authentication protocol used for outgoing calls. Options for this field are: CHAP/PAP - Your ZyWALL will accept either CHAP or PAP when requested by this remote node. CHAP - accept CHAP only. PAP - accept PAP only.
Pri Phone # Sec Phone #	Enter the first (primary) phone number from the ISP for this remote node. If the Primary Phone number is busy or does not answer, your ZyWALL dials the Secondary Phone number if available. Some areas require dialing the pound sign # before the phone number for local calls. Include a # symbol at the beginning of the phone numbers as required.
Edit PPP Options	Move the cursor to this field and use the space bar to select [Yes] and press [Enter] to edit the PPP options for this remote node. This brings you to Menu 11.2.1 - Remote Node PPP Options (see Section 28.7 on page 461).
Edit IP	This field leads to a "hidden" menu. Press [SPACE BAR] to select Yes and press [ENTER] to go to Menu 11.2.2 - Remote Node Network Layer Options . See Section 28.8 on page 461 for more information.
Edit Script Options	Press [SPACE BAR] to select Yes and press [ENTER] to edit the AT script for the dial backup remote node (Menu 11.2.3 - Remote Node Script). See Section 28.9 on page 463 for more information.
Telco Option	
Allocated Budget	Enter the maximum number of minutes that this remote node may be called within the time period configured in the Period field. The default for this field is 0 meaning there is no budget control and no time limit for accessing this remote node.
Period(hr)	Enter the time period (in hours) for how often the budget should be reset. For example, to allow calls to this remote node for a maximum of 10 minutes every hour, set the Allocated Budget to 10 (minutes) and the Period to 1 (hour).
Schedules	You can apply up to four schedule sets here. For more details please refer to Chapter 42 on page 569 .
Always On	Press [SPACE BAR] to select Yes to set this connection to be on all the time, regardless of whether or not there is any traffic. Select No to have this connection act as a dial-up connection.
Session Options	
Edit Filter sets	This field leads to another "hidden" menu. Use [SPACE BAR] to select Yes and press [ENTER] to open menu 11.2.4 to edit the filter sets. See Section 28.10 on page 464 for more details.

Table 171 Menu 11.3: Remote Node Profile (Backup ISP) (continued)

FIELD	DESCRIPTION
Idle Timeout	Enter the number of seconds of idle time (when there is no traffic from the ZyWALL to the remote node) that can elapse before the ZyWALL automatically disconnects the PPP connection. This option only applies when the ZyWALL initiates the call.
Once you have configured this menu, press [ENTER] at the message "Press ENTER to Confirm..." to save your configuration, or press [ESC] at any time to cancel.	

28.7 Editing PPP Options

The ZyWALL's dial back-up feature uses PPP. To edit the remote node PPP Options, move the cursor to the **Edit PPP Options** field in **Menu 11.2 - Remote Node Profile (Backup ISP)**, and use the space bar to select **Yes**. Press [Enter] to open **Menu 11.2.1 - Remote Node PPP Options** as shown next.

Figure 294 Menu 11.2.1: Remote Node PPP Options

```

Menu 11.2.1 - Remote Node PPP Options

Encapsulation= Standard PPP
Compression= No

Enter here to CONFIRM or ESC to CANCEL:

```

This table describes the Remote Node PPP Options Menu, and contains instructions on how to configure the PPP options fields.

Table 172 Menu 11.2.1: Remote Node PPP Options

FIELD	DESCRIPTION
Encapsulation	Press [SPACE BAR] and then [ENTER] to select CISCO PPP if your Dial Backup WAN device uses Cisco PPP encapsulation, otherwise select Standard PPP .
Compression	Press [SPACE BAR] and then [ENTER] to select Yes to enable or No to disable Stac compression.
Once you have configured this menu, press [ENTER] at the message "Press ENTER to Confirm..." to save your configuration, or press [ESC] at any time to cancel.	

28.8 Editing TCP/IP Options

Move the cursor to the **Edit IP** field in menu 11.2, then press [SPACE BAR] to select **Yes**. Press [ENTER] to open **Menu 11.2.2 - Remote Node Network Layer Options**.

Figure 295 Menu 11.2.2: Remote Node Network Layer Options

```

Menu 11.2.2 - Remote Node Network Layer Options

IP Address Assignment= Static
Rem IP Addr= 0.0.0.0
Rem Subnet Mask= 0.0.0.0
My WAN Addr= 0.0.0.0

Network Address Translation= SUA Only
Metric= 15
Private= No
RIP Direction= None
    Version= N/A
Multicast= None

Enter here to CONFIRM or ESC to CANCEL:

```

The following table describes the fields in this menu.

Table 173 Menu 11.2.2: Remote Node Network Layer Options

FIELD	DESCRIPTION
IP Address Assignment	If your ISP did not assign you a fixed IP address, press [SPACE BAR] and then [ENTER] to select Dynamic , otherwise select Static and enter the IP address and subnet mask in the following fields.
Rem IP Address	Enter the (fixed) IP address assigned to you by your ISP (static IP address assignment is selected in the previous field).
Rem Subnet Mask	Enter the subnet mask associated with your static IP.
My WAN Addr	Leave the field set to 0.0.0.0 to have the ISP or other remote router dynamically (automatically) assign your WAN IP address if you do not know it. Enter your WAN IP address here if you know it (static). This is the address assigned to your local ZyWALL, not the remote router.
Network Address Translation	Network Address Translation (NAT) allows the translation of an Internet protocol address used within one network (for example a private IP address used in a local network) to a different IP address known within another network (for example a public IP address used on the Internet). Press [SPACE BAR] and then [ENTER] to select either None or SUA Only . Choose None to disable NAT. Choose SUA Only if you have a single public IP address. SUA (Single User Account) is a subset of NAT that supports two types of mapping: Many-to-One and Server . See Chapter 17 on page 307 for a full discussion on this feature.
Metric	Enter a number from 1 to 15 to set this route's priority among the ZyWALL's routes. The smaller the number, the higher priority the route has.
Private	This parameter determines if the ZyWALL will include the route to this remote node in its RIP broadcasts. If set to Yes , this route is kept private and not included in RIP broadcasts. If No , the route to this remote node will be propagated to other hosts through RIP broadcasts.
RIP Direction	Press [SPACE BAR] and then [ENTER] to select the RIP Direction from Both , None , In Only , Out Only and None .
Version	Press [SPACE BAR] and then [ENTER] to select the RIP version from RIP-1 , RIP-2B and RIP-2M .

Table 173 Menu 11.2.2: Remote Node Network Layer Options

FIELD	DESCRIPTION
Multicast	IGMP (Internet Group Multicast Protocol) is a session-layer protocol used to establish membership in a Multicast group. The ZyWALL supports both IGMP version 1 (IGMP-v1) and version 2 (IGMP-v2). Press the [SPACE BAR] to enable IP Multicasting or select None to disable it. See Section 6.5 on page 125 for more information on this feature.
Once you have completed filling in Menu 11.3.2 Remote Node Network Layer Options , press [ENTER] at the message “Press ENTER to Confirm...” to save your configuration and return to menu 11.3, or press [ESC] at any time to cancel.	

28.9 Editing Login Script

For some remote gateways, text login is required before PPP negotiation is started. The ZyWALL provides a script facility for this purpose. The script has six programmable sets; each set is composed of an ‘Expect’ string and a ‘Send’ string. After matching a message from the server to the ‘Expect’ field, the ZyWALL returns the set’s ‘Send’ string to the server.

For instance, a typical login sequence starts with the server printing a banner, a login prompt for you to enter the user name and a password prompt to enter the password:

```
Welcome to Acme, Inc.
Login: myLogin
Password:
```

To handle the first prompt, you specify “ogin: ” as the ‘Expect’ string and “myLogin” as the ‘Send’ string in set 1. The reason for leaving out the leading “L” is to avoid having to know exactly whether it is upper or lower case. Similarly, you specify “word: ” as the ‘Expect’ string and your password as the ‘Send’ string for the second prompt in set 2.

You can use two variables, \$USERNAME and \$PASSWORD (all UPPER case), to represent the actual user name and password in the script, so they will not show in the clear. They are replaced with the outgoing login name and password in the remote node when the ZyWALL sees them in a ‘Send’ string. Please note that both variables must be entered exactly as shown. No other characters may appear before or after, either, i.e., they must be used alone in response to login and password prompts.

Please note that the ordering of the sets is significant, i.e., starting from set 1, the ZyWALL will wait until the ‘Expect’ string is matched before it proceeds to set 2, and so on for the rest of the script. When both the ‘Expect’ and the ‘Send’ fields of the current set are empty, the ZyWALL will terminate the script processing and start PPP negotiation. This implies two things: first, the sets must be contiguous; the sets after an empty one are ignored. Second, the last set should match the final message sent by the server. For instance, if the server prints:

```
login successful.
Starting PPP...
```

after you enter the password, then you should create a third set to match the final “PPP . . .” but without a “Send” string. Otherwise, the ZyWALL will start PPP prematurely right after sending your password to the server.

If there are errors in the script and it gets stuck at a set for longer than the “Dial Timeout” in menu 2 (default 60 seconds), the ZyWALL will timeout and drop the line. To debug a script, go to Menu 24.4 to initiate a manual call and watch the trace display to see if the sequence of messages and prompts from the server differs from what you expect.

Figure 296 Menu 11.2.3: Remote Node Script

```

Menu 11.2.3 - Remote Node Script

Active= No

Set 1:
  Expect=
  Send=
Set 2:
  Expect=
  Send=
Set 3:
  Expect=
  Send=
Set 4:
  Expect=
  Send=
Set 5:
  Expect=
  Send=
Set 6:
  Expect=
  Send=

Enter here to CONFIRM or ESC to CANCEL:

```

The following table describes the fields in this menu.

Table 174 Menu 11.2.3: Remote Node Script

FIELD	DESCRIPTION
Active	Press [SPACE BAR] and then [ENTER] to select either Yes to enable the AT strings or No to disable them.
Set 1-6: Expect	Enter an Expect string to match. After matching the Expect string, the ZyWALL returns the string in the Send field.
Set 1-6: Send	Enter a string to send out after the Expect string is matched.

28.10 Remote Node Filter

Move the cursor to the field **Edit Filter Sets** in menu 11.2, and then press [SPACE BAR] to set the value to **Yes**. Press [ENTER] to open **Menu 11.2.4 - Remote Node Filter**.

Use menu 11.2.4 to specify the filter set(s) to apply to the incoming and outgoing traffic between this remote node and the ZyWALL to prevent certain packets from triggering calls. You can specify up to four filter sets separated by commas, for example, 1, 5, 9, 12, in each filter field. Note that spaces are accepted in this field. Please refer to [Chapter 36 on page 513](#) for more information on defining the filters.

Figure 297 Menu 11.2.4: Remote Node Filter

```
Menu 11.2.4 - Remote Node Filter

Input Filter Sets:
  protocol filters=
  device filters=
Output Filter Sets:
  protocol filters=
  device filters=
Call Filter Sets:
  protocol filters=
  device filters=

Enter here to CONFIRM or ESC to CANCEL:
```

LAN Setup

This chapter describes how to configure the LAN using **Menu 3 - LAN Setup**.

29.1 Introduction to LAN Setup

This chapter describes how to configure the ZyWALL for LAN connections.

29.2 Accessing the LAN Menus

From the main menu, enter 3 to open **Menu 3 - LAN Setup**.

Figure 298 Menu 3: LAN Setup

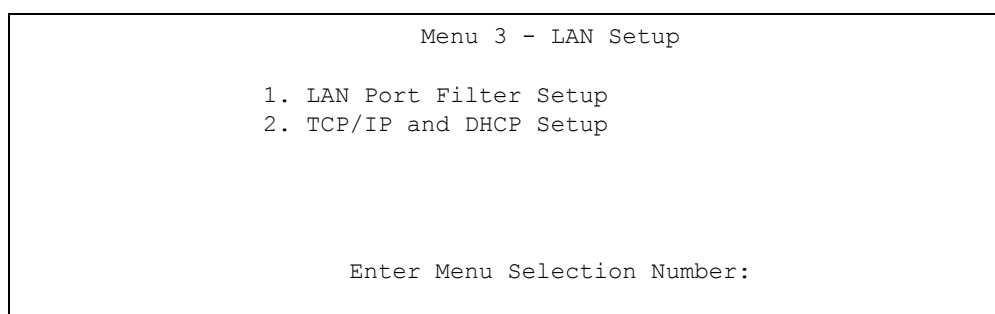

29.3 LAN Port Filter Setup

This menu allows you to specify the filter sets that you wish to apply to the LAN traffic. You seldom need to filter the LAN traffic, however, the filter sets may be useful to block certain packets, reduce traffic and prevent security breaches.

Figure 299 Menu 3.1: LAN Port Filter Setup

```
Menu 3.1 - LAN Port Filter Setup

Input Filter Sets:
  protocol filters=
  device filters=
Output Filter Sets:
  protocol filters=
  device filters=

Press ENTER to Confirm or ESC to Cancel:
```

29.4 TCP/IP and DHCP Ethernet Setup Menu

From the main menu, enter 3 to open **Menu 3 - LAN Setup** to configure TCP/IP (RFC 1155) and DHCP Ethernet setup.

Figure 300 Menu 3: TCP/IP and DHCP Setup

```
Menu 3 - LAN Setup

1. LAN Port Filter Setup
2. TCP/IP and DHCP Setup

Enter Menu Selection Number:
```

From menu 3, select the submenu option **TCP/IP and DHCP Setup** and press [ENTER]. The screen now displays **Menu 3.2 - TCP/IP and DHCP Ethernet Setup**, as shown next. Not all fields are available on all models.

Figure 301 Menu 3.2: TCP/IP and DHCP Ethernet Setup

```

Menu 3.2 - TCP/IP and DHCP Ethernet Setup

DHCP= Server                      TCP/IP Setup:
Client IP Pool:                   IP Address= 192.168.1.1
  Starting Address= 192.168.1.33  IP Subnet Mask= 255.255.255.0
  Size of Client IP Pool= 128     RIP Direction= Both
First DNS Server= From ISP        Version= RIP-1
  IP Address= N/A                 Multicast= None
Second DNS Server= From ISP       Edit IP Alias= No
  IP Address= N/A
Third DNS Server= From ISP
  IP Address= N/A
DHCP Server Address= N/A

Press ENTER to Confirm or ESC to Cancel:

```

Follow the instructions in the next table on how to configure the DHCP fields.

Table 175 Menu 3.2: DHCP Ethernet Setup Fields

FIELD	DESCRIPTION
DHCP	This field enables or disables the DHCP server. If set to Server , your ZyWALL will act as a DHCP server. If set to None , the DHCP server will be disabled. If set to Relay , the ZyWALL acts as a surrogate DHCP server and relays requests and responses between the remote server and the clients. When set to Server , the following items need to be set:
Client IP Pool:	
Starting Address	This field specifies the first of the contiguous addresses in the IP address pool.
Size of Client IP Pool	This field specifies the size, or count of the IP address pool.

Table 175 Menu 3.2: DHCP Ethernet Setup Fields

FIELD	DESCRIPTION
First DNS Server Second DNS Server Third DNS Server	<p>The ZyWALL passes a DNS (Domain Name System) server IP address (in the order you specify here) to the DHCP clients.</p> <p>Select From ISP if your ISP dynamically assigns DNS server information (and the ZyWALL's WAN IP address). The IP Address field below displays the (read-only) DNS server IP address that the ISP assigns.</p> <p>Select User-Defined if you have the IP address of a DNS server. Enter the DNS server's IP address in the IP Address field below. If you chose User-Defined, but leave the IP address set to 0.0.0.0, User-Defined changes to None after you save your changes. If you set a second choice to User-Defined, and enter the same IP address, the second User-Defined changes to None after you save your changes.</p> <p>Select DNS Relay to have the ZyWALL act as a DNS proxy. The ZyWALL's LAN IP address displays in the IP Address field below (read-only). The ZyWALL tells the DHCP clients on the LAN that the ZyWALL itself is the DNS server. When a computer on the LAN sends a DNS query to the ZyWALL, the ZyWALL forwards the query to the ZyWALL's system DNS server (configured in menu 1) and relays the response back to the computer. You can only select DNS Relay for one of the three servers; if you select DNS Relay for a second or third DNS server, that choice changes to None after you save your changes.</p> <p>Select None if you do not want to configure DNS servers. If you do not configure a DNS server, you must know the IP address of a machine in order to access it.</p>
DHCP Server Address	If Relay is selected in the DHCP field above, then type the IP address of the actual, remote DHCP server here.

Use the instructions in the following table to configure TCP/IP parameters for the LAN port.



LAN and DMZ IP addresses must be on separate subnets.

Table 176 Menu 3.2: LAN TCP/IP Setup Fields

FIELD	DESCRIPTION
TCP/IP Setup:	
IP Address	Enter the IP address of your ZyWALL in dotted decimal notation
IP Subnet Mask	Your ZyWALL will automatically calculate the subnet mask based on the IP address that you assign. Unless you are implementing subnetting, use the subnet mask computed by the ZyWALL.
RIP Direction	Press [SPACE BAR] and then [ENTER] to select the RIP direction. Options are: Both , In Only , Out Only or None .
Version	Press [SPACE BAR] and then [ENTER] to select the RIP version. Options are: RIP-1 , RIP-2B or RIP-2M .
Multicast	IGMP (Internet Group Multicast Protocol) is a session-layer protocol used to establish membership in a Multicast group. The ZyWALL supports both IGMP version 1 (IGMP-v1) and version 2 (IGMP-v2). Press [SPACE BAR] and then [ENTER] to enable IP Multicasting or select None (default) to disable it.
Edit IP Alias	The ZyWALL supports three logical LAN interfaces via its single physical Ethernet interface with the ZyWALL itself as the gateway for each LAN network. Press [SPACE BAR] to select Yes and then press [ENTER] to display menu 3.2.1
When you have completed this menu, press [ENTER] at the prompt [Press ENTER to Confirm...] to save your configuration, or press [ESC] at any time to cancel.	

29.4.1 IP Alias Setup

IP alias allows you to partition a physical network into different logical networks over the same Ethernet interface. The ZyWALL supports three logical LAN interfaces via its single physical Ethernet interface with the ZyWALL itself as the gateway for each LAN network.

Use menu 3.2 to configure the first network. Move the cursor to the **Edit IP Alias** field, press [SPACE BAR] to choose **Yes** and press [ENTER] to open **Menu 3.2.1 - IP Alias Setup**, as shown next. Use this menu to configure the second and third networks.

Figure 302 Menu 3.2.1: IP Alias Setup

```

Menu 3.2.1 - IP Alias Setup

IP Alias 1= Yes
IP Address= 192.168.2.1
IP Subnet Mask= 255.255.255.0
RIP Direction= None
Version= RIP-1
Incoming protocol filters=
Outgoing protocol filters=
IP Alias 2= No
IP Address= N/A
IP Subnet Mask= N/A
RIP Direction= N/A
Version= N/A
Incoming protocol filters= N/A
Outgoing protocol filters= N/A

Enter here to CONFIRM or ESC to CANCEL:

```

Use the instructions in the following table to configure IP alias parameters.

Table 177 Menu 3.2.1: IP Alias Setup

FIELD	DESCRIPTION
IP Alias 1, 2	Choose Yes to configure the LAN network for the ZyWALL.
IP Address	Enter the IP address of your ZyWALL in dotted decimal notation.
IP Subnet Mask	Your ZyWALL will automatically calculate the subnet mask based on the IP address that you assign. Unless you are implementing subnetting, use the subnet mask computed by the ZyWALL.
RIP Direction	Press [SPACE BAR] and then [ENTER] to select the RIP direction. Options are Both, In Only, Out Only or None .
Version	Press [SPACE BAR] and then [ENTER] to select the RIP version. Options are RIP-1, RIP-2B or RIP-2M .
Incoming Protocol Filters	Enter the filter set(s) you wish to apply to the incoming traffic between this node and the ZyWALL.
Outgoing Protocol Filters	Enter the filter set(s) you wish to apply to the outgoing traffic between this node and the ZyWALL.
When you have completed this menu, press [ENTER] at the prompt [Press ENTER to Confirm...] to save your configuration, or press [ESC] at any time to cancel.	

Internet Access

This chapter shows you how to configure your ZyWALL for Internet access.

30.1 Introduction to Internet Access Setup

Use information from your ISP along with the instructions in this chapter to set up your ZyWALL to access the Internet. There are three different menu 4 screens depending on whether you chose **Ethernet**, **PPTP** or **PPPoE** Encapsulation. Contact your ISP to determine what encapsulation type you should use.

30.2 Ethernet Encapsulation

If you choose **Ethernet** in menu 4 you will see the next menu.

Figure 303 Menu 4: Internet Access Setup (Ethernet)

```
Menu 4 - Internet Access Setup

ISP's Name= WAN_1
Encapsulation= Ethernet
  Service Type= Standard
  My Login= N/A
  My Password= N/A
  Retype to Confirm= N/A
  Login Server= N/A
  Relogin Every (min)= N/A
IP Address Assignment= Dynamic
  IP Address= N/A
  IP Subnet Mask= N/A
  Gateway IP Address= N/A
Network Address Translation= SUA Only

Press ENTER to Confirm or ESC to Cancel:
```

The following table describes the fields in this menu.

Table 178 Menu 4: Internet Access Setup (Ethernet)

FIELD	DESCRIPTION
ISP's Name	This is the descriptive name of your ISP for identification purposes.
Encapsulation	Press [SPACE BAR] and then press [ENTER] to choose Ethernet . The encapsulation method influences your choices for the IP Address field.
Service Type	Press [SPACE BAR] and then [ENTER] to select Standard , RR-Toshiba (RoadRunner Toshiba authentication method), RR-Manager (RoadRunner Manager authentication method), RR-Telstra or Telia Login . Choose a RoadRunner flavor if your ISP is Time Warner's RoadRunner; otherwise choose Standard .
Note: DSL users must choose the Standard option only. The My Login, My Password and Login Server fields are not applicable in this case.	
My Login	Enter the login name given to you by your ISP.
My Password	Type your password again for confirmation.
Retype to Confirm	Enter your password again to make sure that you have entered is correctly.
Login Server	The ZyWALL will find the RoadRunner Server IP if this field is left blank. If it does not, then you must enter the authentication server IP address.
Relogin Every (min)	This field is available when you select Telia Login in the Service Type field. The Telia server logs the ZyWALL out if the ZyWALL does not log in periodically. Type the number of minutes from 1 to 59 (30 recommended) for the ZyWALL to wait between logins.
IP Address Assignment	If your ISP did not assign you a fixed IP address, press [SPACE BAR] and then [ENTER] to select Dynamic , otherwise select Static and enter the IP address and subnet mask in the following fields.
IP Address	Enter the (fixed) IP address assigned to you by your ISP (static IP address assignment is selected in the previous field).
IP Subnet Mask	Enter the subnet mask associated with your static IP.
Gateway IP Address	Enter the gateway IP address associated with your static IP.
Network Address Translation	Network Address Translation (NAT) allows the translation of an Internet protocol address used within one network (for example a private IP address used in a local network) to a different IP address known within another network (for example a public IP address used on the Internet). Choose None to disable NAT. Choose SUA Only if you have a single public IP address. SUA (Single User Account) is a subset of NAT that supports two types of mapping: Many-to-One and Server . Choose Full Feature if you have multiple public IP addresses. Full Feature mapping types include: One-to-One , Many-to-One (SUA/PAT), Many-to-Many Overload , Many- One-to-One and Server . When you select Full Feature you must configure at least one address mapping set! Please see Chapter 17 on page 307 for a more detailed discussion on the Network Address Translation feature.
When you have completed this menu, press [ENTER] at the prompt "Press ENTER to Confirm..." to save your configuration, or press [ESC] at any time to cancel.	

30.3 Configuring the PPTP Client



The ZyWALL supports only one PPTP server connection at any given time.

To configure a PPTP client, you must configure the **My Login** and **Password** fields for a PPP connection and the PPTP parameters for a PPTP connection.

After configuring **My Login** and **Password** for PPP connection, press [SPACE BAR] and then [ENTER] in the **Encapsulation** field in **Menu 4 -Internet Access Setup** to choose **PPTP** as your encapsulation option. This brings up the following screen.

Figure 304 Internet Access Setup (PPTP)

```

Menu 4 - Internet Access Setup

ISP's Name= ChangeMe
Encapsulation= PPTP
Service Type= N/A
My Login=
My Password= *****
Retype to Confirm= *****
Idle Timeout= 100

IP Address Assignment= Dynamic
IP Address= N/A
IP Subnet Mask= N/A
Gateway IP Address= N/A
Network Address Translation= SUA Only

Press ENTER to Confirm or ESC to Cancel:

```

The following table contains instructions about the new fields when you choose **PPTP** in the **Encapsulation** field in menu 4.

Table 179 New Fields in Menu 4 (PPTP) Screen

FIELD	DESCRIPTION
Encapsulation	Press [SPACE BAR] and then press [ENTER] to choose PPTP . The encapsulation method influences your choices for the IP Address field.
Idle Timeout	This value specifies the time, in seconds, that elapses before the ZyWALL automatically disconnects from the PPTP server.

30.4 Configuring the PPPoE Client

If you enable PPPoE in menu 4, you will see the next screen.

Figure 305 Internet Access Setup (PPPoE)

```

Menu 4 - Internet Access Setup

ISP's Name= ChangeMe
Encapsulation= PPPoE
Service Type= N/A
My Login=
My Password= *****
Retype to Confirm= *****
Idle Timeout= 100

IP Address Assignment= Dynamic
IP Address= N/A
IP Subnet Mask= N/A
Gateway IP Address= N/A
Network Address Translation= SUA Only

Press ENTER to Confirm or ESC to Cancel:

```

The following table contains instructions about the new fields when you choose **PPPoE** in the **Encapsulation** field in menu 4.

Table 180 New Fields in Menu 4 (PPPoE) screen

FIELD	DESCRIPTION
Encapsulation	Press [SPACE BAR] and then press [ENTER] to choose PPPoE . The encapsulation method influences your choices in the IP Address field.
Idle Timeout	This value specifies the time in seconds that elapses before the ZyWALL automatically disconnects from the PPPoE server.

If you need a PPPoE service name to identify and reach the PPPoE server, please go to menu 11 and enter the PPPoE service name provided to you in the **Service Name** field.

30.5 Basic Setup Complete

Well done! You have successfully connected, installed and set up your ZyWALL to operate on your network as well as access the Internet.



When the firewall is activated, the default policy allows all communications to the Internet that originate from the LAN, and blocks all traffic to the LAN that originates from the Internet.

You may deactivate the firewall in menu 21.2 or via the ZyWALL embedded web configurator. You may also define additional firewall rules or modify existing ones but please exercise extreme caution in doing so. See the chapters on firewall for more information on the firewall.

DMZ Setup

This chapter describes how to configure the ZyWALL's DMZ using **Menu 5 - DMZ Setup**.

31.1 Configuring DMZ Setup

From the main menu, enter 5 to open **Menu 5 – DMZ Setup**.

Figure 306 Menu 5: DMZ Setup

```
Menu 5 - DMZ Setup

1. DMZ Port Filter Setup
2. TCP/IP and DHCP Setup

Enter Menu Selection Number:
```

31.2 DMZ Port Filter Setup

This menu allows you to specify the filter sets that you wish to apply to your public server(s) traffic.

Figure 307 Menu 5.1: DMZ Port Filter Setup

```
Menu 5.1 - DMZ Port Filter Setup

Input Filter Sets:
  protocol filters=
  device filters=
Output Filter Sets:
  protocol filters=
  device filters=

Press ENTER to Confirm or ESC to Cancel:
```

31.3 TCP/IP Setup

For more detailed information about RIP setup, IP multicast and IP alias, please refer to [Chapter 6 on page 123](#).

31.3.1 IP Address

From the main menu, enter 5 to open **Menu 5 - DMZ Setup** to configure TCP/IP (RFC 1155).

Figure 308 Menu 5: DMZ Setup

```

Menu 5 - DMZ Setup

1. DMZ Port Filter Setup
2. TCP/IP and DHCP Setup

Enter Menu Selection Number:

```

From menu 5, select the submenu option **2. TCP/IP and DHCP Setup** and press [ENTER]. The screen now displays **Menu 5.2 - TCP/IP and DHCP Ethernet Setup**, as shown next.

Figure 309 Menu 5.2: TCP/IP and DHCP Ethernet Setup

```

Menu 5.2 - TCP/IP and DHCP Ethernet Setup

DHCP= None                    TCP/IP Setup:
Client IP Pool:                IP Address= 10.2.3.4
  Starting Address= N/A        IP Subnet Mask= 255.0.0.0
  Size of Client IP Pool= N/A  RIP Direction= Both
Primary DNS Server= N/A        Version= RIP-1
  IP Address= N/A              Multicast= None
Secondary DNS Server= N/A      Edit IP Alias= No
  IP Address= N/A
Third DNS Server= N/A
  IP Address= N/A
DHCP Server Address= N/A

Press ENTER to Confirm or ESC to Cancel:

```

The DHCP and TCP/IP setup fields are the same as the ones in **Menu 3.2 - TCP/IP and DHCP Ethernet Setup**. Each public server will need a unique IP address. Refer to [Section 29.4 on page 468](#) for information on how to configure these fields.



DMZ, WLAN and LAN IP addresses must be on separate subnets. You must also configure NAT for the DMZ port (see [Chapter 34 on page 493](#)) in menus 15.1 and 15.2.

31.3.2 IP Alias Setup

Use menu 5.2 to configure the first network. Move the cursor to the **Edit IP Alias** field, press [SPACE BAR] to choose **Yes** and press [ENTER] to open **Menu 5.2.1 - IP Alias Setup**, as shown next. Use this menu to configure the second and third networks.

Figure 310 Menu 5.2.1: IP Alias Setup

```

Menu 5.2.1 - IP Alias Setup

IP Alias 1= No
  IP Address= N/A
  IP Subnet Mask= N/A
  RIP Direction= N/A
  Version= N/A
  Incoming protocol filters= N/A
  Outgoing protocol filters= N/A
IP Alias 2= No
  IP Address= N/A
  IP Subnet Mask= N/A
  RIP Direction= N/A
  Version= N/A
  Incoming protocol filters= N/A
  Outgoing protocol filters= N/A

Enter here to CONFIRM or ESC to CANCEL:

```

Refer to [Table 177 on page 471](#) for instructions on configuring IP alias parameters.

Remote Node Setup

This chapter shows you how to configure a remote node.

32.1 Introduction to Remote Node Setup

A remote node is required for placing calls to a remote gateway. A remote node represents both the remote gateway and the network behind it across a WAN connection. Note that when you use menu 4 to set up Internet access, you are actually configuring a remote node. The following describes how to configure **Menu 11.1 - Remote Node Profile**, **Menu 11.1.2 - Remote Node Network Layer Options** and **Menu 11.1.4 - Remote Node Filter**.

32.2 Remote Node Setup

From the main menu, select menu option 11 to open **Menu 11 - Remote Node Setup** (shown below).

Enter **1** to open **Menu 11.1 - Remote Node Profile** and configure the setup for your WAN port. Enter **2** to open **Menu 11.2 Remote Node Profile (Backup ISP)** and configure the setup for your Dial Backup port connection (see [Chapter 28 on page 455](#)).

Figure 311 Menu 11: Remote Node Setup

```
Menu 11 - Remote Node Setup

1. ChangeMe (ISP, SUA)
2. -Dial (BACKUP_ISP, SUA)

Enter Node # to Edit:
```

32.3 Remote Node Profile Setup

The following explains how to configure the remote node profile menu.

32.3.1 Ethernet Encapsulation

There are three variations of menu 11.1 depending on whether you choose **Ethernet Encapsulation**, **PPPoE Encapsulation** or **PPTP Encapsulation**. You must choose the **Ethernet** option when the WAN port is used as a regular Ethernet. The first menu 11.1 screen you see is for Ethernet encapsulation shown next.

Figure 312 Menu 11.1: Remote Node Profile for Ethernet Encapsulation

```

Menu 11.1 - Remote Node Profile

Rem Node Name= WAN_1                Route= IP
Active= Yes

Encapsulation= Ethernet             Edit IP= No
Service Type= Standard              Session Options:
                                     Schedules=
Outgoing:                            Edit Filter Sets= No
  My Login= N/A
  My Password= N/A                  Edit Traffic Redirect= No
  Retype to Confirm= N/A
  Server= N/A
  Relogin Every (min)= N/A

Press ENTER to Confirm or ESC to Cancel:

```

The following table describes the fields in this menu.

Table 181 Menu 11.1: Remote Node Profile for Ethernet Encapsulation

FIELD	DESCRIPTION
Rem Node Name	Enter a descriptive name for the remote node. This field can be up to eight characters.
Active	Press [SPACE BAR] and then [ENTER] to select Yes (activate remote node) or No (deactivate remote node).
Encapsulation	Ethernet is the default encapsulation. Press [SPACE BAR] and then [ENTER] to change to PPPoE or PPTP encapsulation.
Service Type	Press [SPACE BAR] and then [ENTER] to select from Standard , RR-Toshiba (RoadRunner Toshiba authentication method), RR-Manager (RoadRunner Manager authentication method), RR-Telstra or Telia Login . Choose one of the RoadRunner methods if your ISP is Time Warner's RoadRunner; otherwise choose Standard .
Outgoing	
My Login	This field is applicable for PPPoE encapsulation only. Enter the login name assigned by your ISP when the ZyWALL calls this remote node. Some ISPs append this field to the Service Name field above (e.g., jim@poellc) to access the PPPoE server.
My Password	Enter the password assigned by your ISP when the ZyWALL calls this remote node. Valid for PPPoE encapsulation only.
Retype to Confirm	Type your password again to make sure that you have entered it correctly.

Table 181 Menu 11.1: Remote Node Profile for Ethernet Encapsulation (continued)

FIELD	DESCRIPTION
Server	This field is valid only when RoadRunner is selected in the Service Type field. The ZyWALL will find the RoadRunner Server IP automatically if this field is left blank. If it does not, then you must enter the authentication server IP address here.
Relogin Every (min)	This field is available when you select Telia Login in the Service Type field. The Telia server logs the ZyWALL out if the ZyWALL does not log in periodically. Type the number of minutes from 1 to 59 (30 recommended) for the ZyWALL to wait between logins.
Route	This field refers to the protocol that will be routed by your ZyWALL – IP is the only option for the ZyWALL.
Edit IP	This field leads to a “hidden” menu. Press [SPACE BAR] to select Yes and press [ENTER] to go to Menu 11.1.2 - Remote Node Network Layer Options .
Session Options	
Schedules	You can apply up to four schedule sets here. For more details please refer to Chapter 42 on page 569 .
Edit Filter Sets	This field leads to another “hidden” menu. Use [SPACE BAR] to select Yes and press [ENTER] to open menu 11.x.4 to edit the filter sets. See Section 32.5 on page 488 for more details.
Edit Traffic Redirect	Press [SPACE BAR] to select Yes or No . Select No (default) if you do not want to configure this feature. Select Yes and press [ENTER] to configure Menu 11.1.5 - Traffic Redirect Setup .
Once you have configured this menu, press [ENTER] at the message “Press ENTER to Confirm...” to save your configuration, or press [ESC] at any time to cancel.	

32.3.2 PPPoE Encapsulation

The ZyWALL supports PPPoE (Point-to-Point Protocol over Ethernet). You can only use PPPoE encapsulation when you’re using the ZyWALL with a DSL modem as the WAN device. If you change the Encapsulation to **PPPoE**, then you will see the next screen.

Figure 313 Menu 11.1: Remote Node Profile for PPPoE Encapsulation

```

Menu 11.1 - Remote Node Profile

Rem Node Name= ChangeMe           Route= IP
Active= Yes

Encapsulation= PPPoE              Edit IP= No
Service Type= Standard            Telco Option:
Service Name=                     Allocated Budget(min)= 0
Outgoing:                          Period(hr)= 0
  My Login=                        Schedules=
  My Password= *****            Nailed-Up Connection= No
  Retype to Confirm= *****
  Authen= CHAP/PAP

                                   Session Options:
                                   Edit Filter Sets= No
                                   Idle Timeout(sec)= 100

                                   Edit Traffic Redirect= No

Press ENTER to Confirm or ESC to Cancel:

```

32.3.2.1 Outgoing Authentication Protocol

Generally speaking, you should employ the strongest authentication protocol possible, for obvious reasons. However, some vendor's implementation includes a specific authentication protocol in the user profile. It will disconnect if the negotiated protocol is different from that in the user profile, even when the negotiated protocol is stronger than specified. If you encounter a case where the peer disconnects right after a successful authentication, please make sure that you specify the correct authentication protocol when connecting to such an implementation.

32.3.2.2 Nailed-Up Connection

A nailed-up connection is a dial-up line where the connection is always up regardless of traffic demand. The ZyWALL does two things when you specify a nailed-up connection. The first is that idle timeout is disabled. The second is that the ZyWALL will try to bring up the connection when turned on and whenever the connection is down. A nailed-up connection can be very expensive for obvious reasons.

Do not specify a nailed-up connection unless your telephone company offers flat-rate service or you need a constant connection and the cost is of no concern.

The following table describes the fields not already described in [Table 181 on page 482](#).

32.3.2.3 Metric

See [Section 8.2 on page 141](#) for details on the **Metric** field.

Table 182 Fields in Menu 11.1 (PPPoE Encapsulation Specific)

FIELD	DESCRIPTION
Service Name	If you are using PPPoE encapsulation, then type the name of your PPPoE service here. Only valid with PPPoE encapsulation.
Authen	This field sets the authentication protocol used for outgoing calls. Options for this field are: CHAP/PAP - Your ZyWALL will accept either CHAP or PAP when requested by this remote node. CHAP - accept CHAP only. PAP - accept PAP only.
Telco Option	
Allocated Budget	The field sets a ceiling for outgoing call time for this remote node. The default for this field is 0 meaning no budget control.
Period(hr)	This field is the time period that the budget should be reset. For example, if we are allowed to call this remote node for a maximum of 10 minutes every hour, then the Allocated Budget is (10 minutes) and the Period(hr) is 1 (hour).
Schedules	You can apply up to four schedule sets here. For more details please refer to Chapter 42 on page 569 .
Nailed-Up Connection	This field specifies if you want to make the connection to this remote node a nailed-up connection. More details are given earlier in this section.
Session Options	
Idle Timeout	Type the length of idle time (when there is no traffic from the ZyWALL to the remote node) in seconds that can elapse before the ZyWALL automatically disconnects the PPPoE connection. This option only applies when the ZyWALL initiates the call.

32.3.3 PPTP Encapsulation

If you change the Encapsulation to **PPTP** in menu 11.1, then you will see the next screen.

Figure 314 Menu 11.1: Remote Node Profile for PPTP Encapsulation

```

Menu 11.1 - Remote Node Profile

Rem Node Name= ChangeMe           Route= IP
Active= Yes

Encapsulation= PPTP               Edit IP= No
Service Type= Standard            Telco Option:
                                   Allocated Budget (min)= 0
                                   Period(hr)= 0
                                   Schedules=
Outgoing:                          Nailed-Up Connection= No
  My Login=
  My Password= *****
  Retype to Confirm= *****
  Authen= CHAP/PAP
PPTP:                               Session Options:
  My IP Addr= 10.0.0.140           Edit Filter Sets= No
  My IP Mask= 255.255.255.0       Idle Timeout(sec)= 100
  Server IP Addr= 10.0.0.138
  Connection ID/Name=             Edit Traffic Redirect= No

                                   Press ENTER to Confirm or ESC to Cancel:

```

The next table shows how to configure fields in menu 11.1 not previously discussed.

Table 183 Menu 11.1: Remote Node Profile for PPTP Encapsulation

FIELD	DESCRIPTION
Encapsulation	Press [SPACE BAR] and then [ENTER] to select PPTP . You must also go to menu 11.3 to check the IP Address setting once you have selected the encapsulation method.
My IP Addr	Enter the IP address of the WAN Ethernet port.
My IP Mask	Enter the subnet mask of the WAN Ethernet port.
Server IP Addr	Enter the IP address of the ANT modem.
Connection ID/ Name	Enter the connection ID or connection name in the ANT. It must follow the "c:id" and "n:name" format. This field is optional and depends on the requirements of your DSL modem.
Schedules	You can apply up to four schedule sets here. For more details refer to Chapter 42 on page 569 .
Nailed-Up Connections	Press [SPACE BAR] and then [ENTER] to select Yes if you want to make the connection to this remote node a nailed-up connection.

32.4 Edit IP

Move the cursor to the **Edit IP** field in menu 11.1, then press [SPACE BAR] to select **Yes**. Press [ENTER] to open **Menu 11.1.2 - Remote Node Network Layer Options**. Not all fields are available on all models.

Figure 315 Menu 11.1.2: Remote Node Network Layer Options for Ethernet Encapsulation

```

Menu 11.1.2 - Remote Node Network Layer Options

IP Address Assignment= Dynamic
Rem IP Addr= N/A
Rem Subnet Mask= N/A
My WAN Addr= N/A

Network Address Translation= SUA Only
Metric= 1
Private= No
RIP Direction= None
  Version= N/A
Multicast= None

Enter here to CONFIRM or ESC to CANCEL:

```

This menu displays the **My WAN Addr** field for **PPPoE** and **PPTP** encapsulations and **Gateway IP Addr** field for **Ethernet** encapsulation. The following table describes the fields in this menu.

Table 184 Remote Node Network Layer Options Menu Fields

FIELD	DESCRIPTION
IP Address Assignment	If your ISP did not assign you an explicit IP address, press [SPACE BAR] and then [ENTER] to select Dynamic ; otherwise select Static and enter the IP address & subnet mask in the following fields.
(Rem) IP Address	If you have a static IP Assignment, enter the IP address assigned to you by your ISP.
(Rem) IP Subnet Mask	If you have a static IP Assignment, enter the subnet mask assigned to you.
Gateway IP Addr	This field is applicable to Ethernet encapsulation only. Enter the gateway IP address assigned to you if you are using a static IP address.
My WAN Addr	This field is applicable to PPPoE and PPTP encapsulations only. Some implementations, especially the UNIX derivatives, require the WAN link to have a separate IP network number from the LAN and each end must have a unique address within the WAN network number. If this is the case, enter the IP address assigned to the WAN port of your ZyWALL. Note that this is the address assigned to your local ZyWALL, not the remote router.
Network Address Translation	Network Address Translation (NAT) allows the translation of an Internet protocol address used within one network (for example a private IP address used in a local network) to a different IP address known within another network (for example a public IP address used on the Internet). Choose None to disable NAT. Choose SUA Only if you have a single public IP address. SUA (Single User Account) is a subset of NAT that supports two types of mapping: Many-to-One and Server . Choose Full Feature if you have multiple public IP addresses. Full Feature mapping types include: One-to-One , Many-to-One (SUA/PAT), Many-to-Many Overload , Many- One-to-One and Server . When you select Full Feature you must configure at least one address mapping set. See Chapter 17 on page 307 for a full discussion on this feature.

Table 184 Remote Node Network Layer Options Menu Fields (continued)

FIELD	DESCRIPTION
Metric	Enter a number from 1 to 15 to set this route's priority among the ZyWALL's routes (see Section 8.2 on page 141). The smaller the number, the higher priority the route has.
Private	This field is valid only for PPTP/PPPoE encapsulation. This parameter determines if the ZyWALL will include the route to this remote node in its RIP broadcasts. If set to Yes , this route is kept private and not included in RIP broadcast. If No , the route to this remote node will be propagated to other hosts through RIP broadcasts.
RIP Direction	Press [SPACE BAR] and then [ENTER] to select the RIP direction from Both/ None/In Only/Out Only . See Chapter 6 on page 123 for more information on RIP. The default for RIP on the WAN side is None . It is recommended that you do not change this setting.
Version	Press [SPACE BAR] and then [ENTER] to select the RIP version from RIP-1/RIP-2B/RIP-2M or None .
Multicast	IGMP (Internet Group Multicast Protocol) is a network-layer protocol used to establish membership in a Multicast group. The ZyWALL supports both IGMP version 1 (IGMP-v1) and version 2 (IGMP-v2). Press [SPACE BAR] to enable IP Multicasting or select None to disable it. See Chapter 6 on page 123 for more information on this feature.
Once you have completed filling in Menu 11.3 Remote Node Network Layer Options , press [ENTER] at the message "Press ENTER to Confirm..." to save your configuration and return to menu 11, or press [ESC] at any time to cancel.	

32.5 Remote Node Filter

Move the cursor to the field **Edit Filter Sets** in menu 11.1, and then press [SPACE BAR] to set the value to **Yes**. Press [ENTER] to open **Menu 11.1.4 - Remote Node Filter**.

Use menu 11.1.4 to specify the filter set(s) to apply to the incoming and outgoing traffic between this remote node and the ZyWALL to prevent certain packets from triggering calls. You can specify up to 4 filter sets separated by commas, for example, 1, 5, 9, 12, in each filter field. Note that spaces are accepted in this field. For more information on defining the filters, please refer to [Chapter 36 on page 513](#). For PPPoE or PPTP encapsulation, you have the additional option of specifying remote node call filter sets.

Figure 316 Menu 11.1.4: Remote Node Filter (Ethernet Encapsulation)

```

Menu 11.1.4 - Remote Node Filter

Input Filter Sets:
  protocol filters=
  device filters=
Output Filter Sets:
  protocol filters=
  device filters=

Enter here to CONFIRM or ESC to CANCEL:

```

Figure 317 Menu 11.1.4: Remote Node Filter (PPPoE or PPTP Encapsulation)

```

Menu 11.1.4 - Remote Node Filter

Input Filter Sets:
  protocol filters=
  device filters=
Output Filter Sets:
  protocol filters=
  device filters=
Call Filter Sets:
  protocol filters=
  device filters=

Enter here to CONFIRM or ESC to CANCEL:

```

32.6 Traffic Redirect

Configure parameters that determine when the ZyWALL will forward WAN traffic to the backup gateway using **Menu 11.1.5 - Traffic Redirect Setup**.

Figure 318 Menu 11.1.5: Traffic Redirect Setup

```

Menu 11.1.5 - Traffic Redirect Setup

Active= Yes
Configuration:
  Backup Gateway IP Address= 0.0.0.0
  Metric= 14
  Check WAN IP Address= 0.0.0.0
  Fail Tolerance= 10
  Period(sec)= 300
  Timeout(sec)= 8

Press ENTER to Confirm or ESC to Cancel:

```

The following table describes the fields in this menu.

Table 185 Menu 11.1.5: Traffic Redirect Setup

FIELD	DESCRIPTION
Active	Press [SPACE BAR] and select Yes (to enable) or No (to disable) traffic redirect setup. The default is No.
Configuration	
Backup Gateway IP Address	Enter the IP address of your backup gateway in dotted decimal notation. The ZyWALL automatically forwards traffic to this IP address if the ZyWALL's Internet connection terminates.

Table 185 Menu 11.1.5: Traffic Redirect Setup

FIELD	DESCRIPTION
Metric	This field sets this route's priority among the routes the ZyWALL uses. Enter a number from 1 to 15 to set this route's priority among the ZyWALL's routes (see Section 8.2 on page 141) The smaller the number, the higher priority the route has.
Check WAN IP Address	Enter the IP address of a reliable nearby computer (for example, your ISP's DNS server address) to test your ZyWALL's WAN accessibility. The ZyWALL uses the default gateway IP address if you do not enter an IP address here. If you are using PPTP or PPPoE Encapsulation, enter "0.0.0.0" to configure the ZyWALL to check the PVC (Permanent Virtual Circuit) or PPTP tunnel.
Fail Tolerance	Enter the number of times your ZyWALL may attempt and fail to connect to the Internet before traffic is forwarded to the backup gateway. Two to five is usually a good number.
Period(sec)	Enter the time interval (in seconds) between WAN connection checks. Five to 60 is usually a good number.
Timeout(sec)	Enter the number of seconds the ZyWALL waits for a ping response from the IP Address in the Check WAN IP Address field before it times out. The number in this field should be less than the number in the Period field. Three to 50 is usually a good number. The WAN connection is considered "down" after the ZyWALL times out the number of times specified in the Fail Tolerance field.
When you have completed this menu, press [ENTER] at the prompt "Press ENTER to Confirm..." to save your configuration, or press [ESC] at any time to cancel.	

IP Static Route Setup

This chapter shows you how to configure static routes with your ZyWALL.

33.1 IP Static Route Setup

Enter 12 from the main menu. Select one of the IP static routes as shown next to configure IP static routes in menu 12.1.



The first static route entry is for the default WAN route on the ZyWALL. You cannot modify or delete a static default route. The default route is disabled after you change the static WAN IP address to a dynamic WAN IP address. The “-” before a route name indicates the static route is inactive.

Figure 319 Menu 12: IP Static Route Setup

```
Menu 12 - IP Static Route Setup

1. Reserved
2. test1
3. -test2
4. _____
5. _____
6. _____
7. _____
8. _____
9. _____
10. _____
11. _____
12. _____

Enter selection number:
```

Now, enter the index number of the static route that you want to configure.

Figure 320 Menu 12. 1: Edit IP Static Route

```

Menu 12.1 - Edit IP Static Route

Route #: 3
Route Name= ?
Active= No
Destination IP Address= ?
IP Subnet Mask= ?
Gateway IP Address= ?
Metric= 2
Private= No

Press ENTER to CONFIRM or ESC to CANCEL:

```

The following table describes the IP Static Route Menu fields.

Table 186 Menu 12. 1: Edit IP Static Route

FIELD	DESCRIPTION
Route #	This is the index number of the static route that you chose in menu 12.
Route Name	Enter a descriptive name for this route. This is for identification purposes only.
Active	This field allows you to activate/deactivate this static route.
Destination IP Address	This parameter specifies the IP network address of the final destination. Routing is always based on network number. If you need to specify a route to a single host, use a subnet mask of 255.255.255.255 in the subnet mask field to force the network number to be identical to the host ID.
IP Subnet Mask	Enter the IP subnet mask for this destination.
Gateway IP Address	Enter the IP address of the gateway. The gateway is an immediate neighbor of your ZyWALL that will forward the packet to the destination. On the LAN, the gateway must be a router on the same segment as your ZyWALL; over the WAN, the gateway must be the IP address of one of the remote nodes.
Metric	Enter a number from 1 to 15 to set this route's priority among the ZyWALL's routes (see Section 8.2 on page 141). The smaller the number, the higher priority the route has.
Private	This parameter determines if the ZyWALL will include the route to this remote node in its RIP broadcasts. If set to Yes , this route is kept private and not included in RIP broadcast. If No , the route to this remote node will be propagated to other hosts through RIP broadcasts.
Once you have completed filling in this menu, press [ENTER] at the message "Press ENTER to Confirm..." to save your configuration, or press [ESC] to cancel.	

Network Address Translation (NAT)

This chapter discusses how to configure NAT on the ZyWALL.

34.1 Using NAT



You must create a firewall rule in addition to setting up SUA/NAT, to allow traffic from the WAN to be forwarded through the ZyWALL.

34.1.1 SUA (Single User Account) Versus NAT

SUA (Single User Account) is a ZyNOS implementation of a subset of NAT that supports two types of mapping, **Many-to-One** and **Server**. See [Section 34.2.1 on page 495](#) for a detailed description of the NAT set for SUA. The ZyWALL also supports **Full Feature** NAT to map multiple global IP addresses to multiple private LAN IP addresses of clients or servers using mapping types.



Choose SUA Only if you have just one public WAN IP address for your ZyWALL.

Choose Full Feature if you have multiple public WAN IP addresses for your ZyWALL.

34.1.2 Applying NAT

You apply NAT via menus 4 or 11.1.2 as displayed next. The next figure shows you how to apply NAT for Internet access in menu 4. Enter 4 from the main menu to go to **Menu 4 - Internet Access Setup**.

Figure 321 Menu 4: Applying NAT for Internet Access

```
Menu 4 - Internet Access Setup

ISP's Name= ChangeMe
Encapsulation= Ethernet
  Service Type= Standard
My Login= N/A
My Password= N/A
Retype to Confirm= N/A
Login Server= N/A
Relogin Every (min)= N/A
IP Address Assignment= Dynamic
  IP Address= N/A
  IP Subnet Mask= N/A
  Gateway IP Address= N/A
Network Address Translation= SUA Only

Press ENTER to Confirm or ESC to Cancel:
```

The following figure shows how you apply NAT to the remote node in menu 11.1.

- 1 Enter 11 from the main menu.
- 2 Enter 1 to open **Menu 11.1 - Remote Node Profile**.
- 3 Move the cursor to the **Edit IP** field, press [SPACE BAR] to select **Yes** and then press [ENTER] to bring up **Menu 11.1.2 - Remote Node Network Layer Options**.

Figure 322 Menu 11.1.2: Applying NAT to the Remote Node

```
Menu 11.1.2 - Remote Node Network Layer Options

IP Address Assignment= Dynamic
IP Address= N/A
IP Subnet Mask= N/A
Gateway IP Addr= N/A

Network Address Translation= Full Feature
Metric= 1
Private= N/A
RIP Direction= None
  Version= N/A
Multicast= None

Enter here to CONFIRM or ESC to CANCEL:
```

The following table describes the fields in this menu.

Table 187 Applying NAT in Menus 4 & 11.1.2

FIELD	DESCRIPTION	OPTIONS
Network Address Translation	When you select this option the SMT will use Address Mapping Set 1 (menu 15.1 - see Section 34.2.1 on page 495 for further discussion). You can configure any of the mapping types described in Chapter 17 on page 307 . Choose Full Feature if you have multiple public WAN IP addresses for your ZyWALL. When you select Full Feature you must configure at least one address mapping set.	Full Feature
	NAT is disabled when you select this option.	None
	When you select this option the SMT will use Address Mapping Set 255 (menu 15.1 - see Section 34.2.1 on page 495). Choose SUA Only if you have just one public WAN IP address for your ZyWALL.	SUA Only

34.2 NAT Setup

Use the address mapping sets menus and submenus to create the mapping table used to assign global addresses to computers on the LAN, WLAN and DMZ. **Set 255** is used for SUA. When you select **Full Feature** in menu 4, menu 11.1.2, the SMT will use **Set 1**. When you select **SUA Only**, the SMT will use the pre-configured **Set 255** (read only).

The server set is a list of LAN, WLAN and DMZ servers mapped to external ports. To use this set, a server rule must be set up inside the NAT address mapping set. Please see the section on port forwarding in [Chapter 17 on page 307](#) for further information on these menus. To configure NAT, enter 15 from the main menu to bring up the following screen.

Figure 323 Menu 15: NAT Setup

```

Menu 15 - NAT Setup

    1. Address Mapping Sets
    2. Port Forwarding Setup
    3. Trigger Port Setup

Enter Menu Selection Number:

```



Configure DMZ, WLAN and LAN IP addresses in NAT menus 15.1 and 15.2. DMZ, WLAN and LAN IP addresses must be on separate subnets.

34.2.1 Address Mapping Sets

Enter 1 to bring up **Menu 15.1 - Address Mapping Sets**.

Figure 324 Menu 15.1: Address Mapping Sets

```

Menu 15.1 - Address Mapping Sets

    1. NAT_SET
    255. SUA (read only)

Enter Menu Selection Number:

```

34.2.1.1 SUA Address Mapping Set

Enter 255 to display the next screen (see also [Section 34.1.1 on page 493](#)). The fields in this menu cannot be changed.

Figure 325 Menu 15.1.255: SUA Address Mapping Rules

```

Menu 15.1.255 - Address Mapping Rules

Set Name= SUA

Idx  Local Start IP  Local End IP  Global Start IP  Global End IP  Type
---  -
1.   0.0.0.0         255.255.255.255  0.0.0.0         M-1
2.                                     0.0.0.0         Server
3.
4.
5.
6.
7.
8.
9.
10.

Press ENTER to Confirm or ESC to Cancel:

```

The following table explains the fields in this menu.



Menu 15.1.255 is read-only.

Table 188 SUA Address Mapping Rules

FIELD	DESCRIPTION
Set Name	This is the name of the set you selected in menu 15.1 or enter the name of a new set you want to create.
Idx	This is the index or rule number.
Local Start IP	Local Start IP is the starting local IP address (ILA).
Local End IP	Local End IP is the ending local IP address (ILA). If the rule is for all local IPs, then the start IP is 0.0.0.0 and the end IP is 255.255.255.255.
Global Start IP	This is the starting global IP address (IGA). If you have a dynamic IP, enter 0.0.0.0 as the Global Start IP .
Global End IP	This is the ending global IP address (IGA).
Type	These are the mapping types discussed above. Server allows us to specify multiple servers of different types behind NAT to this machine. See later for some examples.
Once you have finished configuring a rule in this menu, press [ENTER] at the message "Press ENTER to Confirm..." to save your configuration, or press [ESC] to cancel.	

34.2.1.2 User-Defined Address Mapping Sets

Now look at option 1 in menu 15.1. Enter 1 to bring up this menu. Look at the differences from the previous menu. Note the extra **Action** and **Select Rule** fields mean you can configure rules in this screen. Note also that the [?] in the **Set Name** field means that this is a required field and you must enter a name for the set.



The entire set will be deleted if you leave the Set Name field blank and press [ENTER] at the bottom of the screen.

Figure 326 Menu 15.1.1: First Set

```

Menu 15.1.1 - Address Mapping Rules

Set Name= NAT_SET

Idx  Local Start IP  Local End IP  Global Start IP  Global End IP  Type
---  -
1.   0.0.0.0         255.255.255.255  0.0.0.0         M-1
2.                                     0.0.0.0         Server
3.
4.
5.
6.
7.
8.
9.
10.

Action= None          Select Rule= N/A

Press ENTER to Confirm or ESC to Cancel:

```



The Type, Local and Global Start/End IPs are configured in menu 15.1.1.1 (described later) and the values are displayed here.

34.2.1.3 Ordering Your Rules

Ordering your rules is important because the ZyWALL applies the rules in the order that you specify. When a rule matches the current packet, the ZyWALL takes the corresponding action and the remaining rules are ignored. If there are any empty rules before your new configured rule, your configured rule will be pushed up by that number of empty rules. For example, if you have already configured rules 1 to 6 in your current set and now you configure rule number 9. In the set summary screen, the new rule will be rule 7, not 9.

Now if you delete rule 4, rules 5 to 7 will be pushed up by 1 rule, so as old rule 5 becomes rule 4, old rule 6 becomes rule 5 and old rule 7 becomes rule 6.

Table 189 Fields in Menu 15.1.1

FIELD	DESCRIPTION
Set Name	Enter a name for this set of rules. This is a required field. If this field is left blank, the entire set will be deleted.
Action	The default is Edit . Edit means you want to edit a selected rule (see following field). Insert Before means to insert a rule before the rule selected. The rules after the selected rule will then be moved down by one rule. Delete means to delete the selected rule and then all the rules after the selected one will be advanced one rule. None disables the Select Rule item.
Select Rule	When you choose Edit , Insert Before or Delete in the previous field the cursor jumps to this field to allow you to select the rule to apply the action in question.



You must press [ENTER] at the bottom of the screen to save the whole set. You must do this again if you make any changes to the set – including deleting a rule. No changes to the set take place until this action is taken.

Selecting **Edit** in the **Action** field and then selecting a rule brings up the following menu, **Menu 15.1.1.1 - Address Mapping Rule** in which you can edit an individual rule and configure the **Type**, **Local** and **Global Start/End IPs**.



An IP End address must be numerically greater than its corresponding IP Start address.

Figure 327 Menu 15.1.1.1: Editing/Configuring an Individual Rule in a Set

```

Menu 15.1.1.1 Address Mapping Rule

Type= One-to-One

Local IP:
  Start=
  End = N/A

Global IP:
  Start=
  End = N/A

Server Mapping Set= N/A

Press ENTER to Confirm or ESC to Cancel:

```

The following table describes the fields in this menu.

Table 190 Menu 15.1.1.1: Editing/Configuring an Individual Rule in a Set

FIELD	DESCRIPTION
Type	Press [SPACE BAR] and then [ENTER] to select from a total of five types. These are the mapping types discussed in Chapter 17 on page 307 . Server allows you to specify multiple servers of different types behind NAT to this computer. See Section 34.4.3 on page 504 for an example.
Local IP	Only local IP fields are N/A for server; Global IP fields MUST be set for Server .
Start	Enter the starting local IP address (ILA).
End	Enter the ending local IP address (ILA). If the rule is for all local IPs, then put the Start IP as 0.0.0.0 and the End IP as 255.255.255.255. This field is N/A for One-to-One and Server types.
Global IP	

Table 190 Menu 15.1.1.1: Editing/Configuring an Individual Rule in a Set

FIELD	DESCRIPTION
Start	Enter the starting global IP address (IGA). If you have a dynamic IP, enter 0.0.0.0 as the Global IP Start . Note that Global IP Start can be set to 0.0.0.0 only if the types are Many-to-One or Server .
End	Enter the ending global IP address (IGA). This field is N/A for One-to-One , Many-to-One and Server types.
Server Mapping Set	This field is available only when you select Server in the Type field.
Once you have finished configuring a rule in this menu, press [ENTER] at the message "Press ENTER to Confirm..." to save your configuration, or press [ESC] to cancel.	

34.3 Configuring a Server behind NAT



If you do not assign a Default Server IP address, the ZyWALL discards all packets received for ports that are not specified here or in the remote management setup.

Follow these steps to configure a server behind NAT:

- 1 Enter 15 in the main menu to go to **Menu 15 - NAT Setup**.
- 2 Enter 2 to open menu 15.2 and configure the address mapping rules for the WAN port.

Figure 328 Menu 15.2: NAT Server Sets

Menu 15.2 - NAT Server Setup					
Default Server: 0.0.0.0					
Rule	Act.	Start Port	End Port	IP Address	
001	No	0	0	0.0.0.0	
002	No	0	0	0.0.0.0	
003	No	0	0	0.0.0.0	
004	No	0	0	0.0.0.0	
005	No	0	0	0.0.0.0	
006	No	0	0	0.0.0.0	
007	No	0	0	0.0.0.0	
008	No	0	0	0.0.0.0	
009	No	0	0	0.0.0.0	
010	No	0	0	0.0.0.0	
Select Command= None		Select Rule= N/A			
Press ENTER to Confirm or ESC to Cancel:					

- 3 Select **Edit Rule** in the **Select Command** field; type the index number of the NAT server you want to configure in the **Select Rule** field and press [ENTER] to open **Menu 15.2.x - NAT Server Configuration** (see the next figure).

Figure 329 15.2.1: NAT Server Configuration

```

15.2.1 - NAT Server Configuration

                                Index= 1

-----

Name= test

Active= Yes

Start port= 21                    End port= 25

IP Address= 192.168.1.33

Press ENTER to Confirm or ESC to Cancel:

```

The following table describes the fields in this screen.

Table 191 15.2.1: NAT Server Configuration

FIELD	DESCRIPTION
Index	This is the index number of an individual port forwarding server entry.
Name	Enter a name to identify this port-forwarding rule.
Active	Press [SPACE BAR] and then [ENTER] to select Yes to enable the NAT server entry.
Start Port	Enter a port number in the Start Port field. To forward only one port, enter it again in the End Port field. To specify a range of ports, enter the last port to be forwarded in the End Port field.
End Port	
IP Address	Enter the inside IP address of the server.
When you have completed this menu, press [ENTER] at the prompt "Press ENTER to Confirm..." to save your configuration, or press [ESC] at any time to cancel.	

- 4 Enter a port number in the **Start Port** field. To forward only one port, enter it again in the **End Port** field. To specify a range of ports, enter the last port to be forwarded in the **End Port** field.
- 5 Enter the inside IP address of the server in the **IP Address** field. In the following figure, you have a computer acting as an FTP, Telnet and SMTP server (ports 21, 23 and 25) at 192.168.1.33.
- 6 Press [ENTER] at the "Press ENTER to confirm ..." prompt to save your configuration after you define all the servers or press [ESC] at any time to cancel.

Figure 330 Menu 15.2: NAT Server Setup

Menu 15.2 - NAT Server Setup				
Default Server: 0.0.0.0				
Rule	Act.	Start Port	End Port	IP Address
001	No	0	0	0.0.0.0
002	Yes	21	25	192.168.1.33
003	No	0	0	0.0.0.0
004	No	0	0	0.0.0.0
005	No	0	0	0.0.0.0
006	No	0	0	0.0.0.0
007	No	0	0	0.0.0.0
008	No	0	0	0.0.0.0
009	No	0	0	0.0.0.0
010	No	0	0	0.0.0.0

Select Command= None Select Rule= N/A
Press ENTER to Confirm or ESC to Cancel:

You assign the private network IP addresses. The NAT network appears as a single host on the Internet. A is the FTP/Telnet/SMTP server.

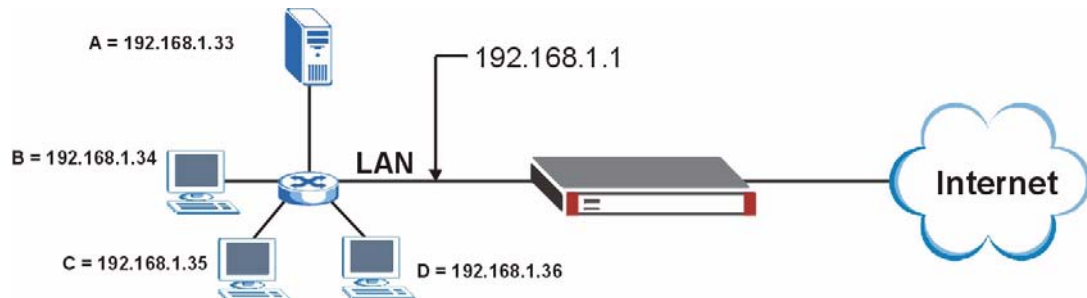
Figure 331 Server Behind NAT Example

34.4 General NAT Examples

The following are some examples of NAT configuration.

34.4.1 Internet Access Only

In the following Internet access example, you only need one rule where all your ILAs (Inside Local addresses) map to one dynamic IGA (Inside Global Address) assigned by your ISP.

Figure 332 NAT Example 1

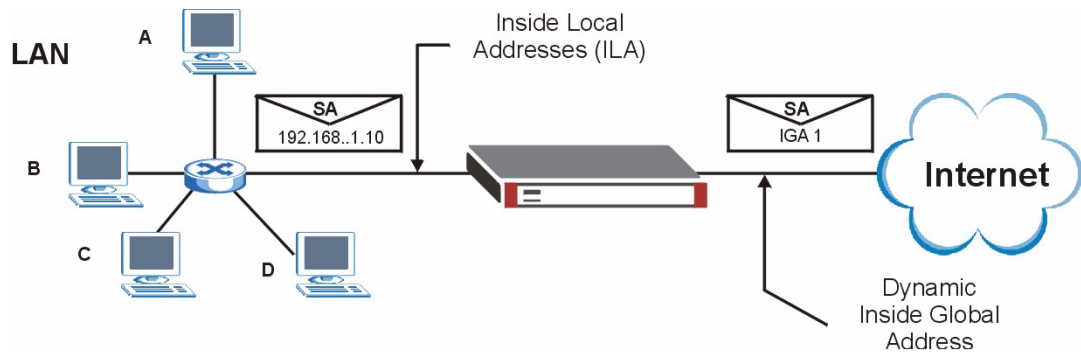

Figure 333 Menu 4: Internet Access & NAT Example

```

Menu 4 - Internet Access Setup

ISP's Name= ChangeMe
Encapsulation= Ethernet
Service Type= Standard
My Login= N/A
My Password= N/A
Retype to Confirm= N/A
Login Server= N/A
Relogin Every (min)= N/A
IP Address Assignment= Dynamic
IP Address= N/A
IP Subnet Mask= N/A
Gateway IP Address= N/A
Network Address Translation= SUA Only

Press ENTER to Confirm or ESC to Cancel:

```

From menu 4 shown above, simply choose the **SUA Only** option from the **Network Address Translation** field. This is the Many-to-One mapping discussed in [Section 34.4 on page 502](#). The **SUA Only** read-only option from the **Network Address Translation** field in menus 4 and 11.1.2 is specifically pre-configured to handle this case.

34.4.2 Example 2: Internet Access with a Default Server

Figure 334 NAT Example 2

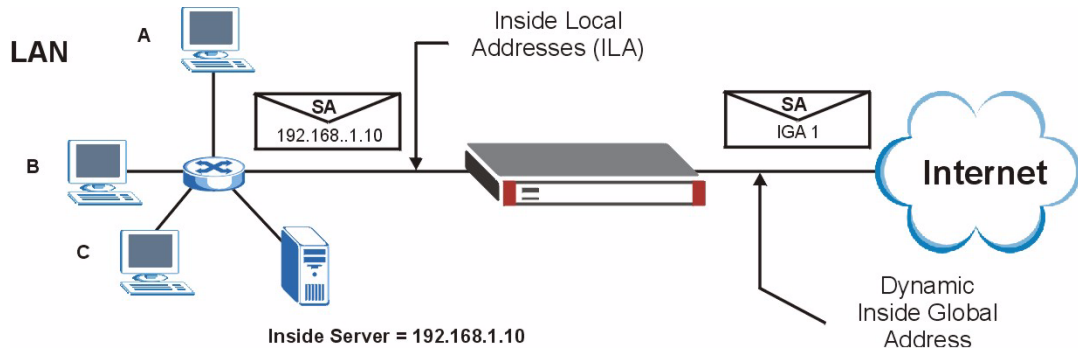

In this case, you do exactly as above (use the convenient pre-configured **SUA Only** set) and also go to menu 15.2 to specify the **Default Server** behind the NAT as shown in the next figure.

Figure 335 Menu 15.2: Specifying an Inside Server

```

Menu 15.2 - NAT Server Setup

Default Server: 192.168.1.10

```

Rule	Act.	Start Port	End Port	IP Address
001	No	0	0	0.0.0.0
002	Yes	21	25	192.168.1.33
003	No	0	0	0.0.0.0
004	No	0	0	0.0.0.0
005	No	0	0	0.0.0.0
006	No	0	0	0.0.0.0
007	No	0	0	0.0.0.0
008	No	0	0	0.0.0.0
009	No	0	0	0.0.0.0
010	No	0	0	0.0.0.0

```

Select Command= None          Select Rule= N/A
Press ENTER to Confirm or ESC to Cancel:

```

34.4.3 Example 3: Multiple Public IP Addresses With Inside Servers

In this example, there are 3 IGAs from our ISP. There are many departments but two have their own FTP server. All departments share the same router. The example will reserve one IGA for each department with an FTP server and all departments use the other IGA. Map the FTP servers to the first two IGAs and the other LAN traffic to the remaining IGA. Map the third IGA to an inside web server and mail server. Four rules need to be configured, two bi-directional and two uni-directional as follows.

- 1 Map the first IGA to the first inside FTP server for FTP traffic in both directions (1 : 1 mapping, giving both local and global IP addresses).

- 2 Map the second IGA to our second inside FTP server for FTP traffic in both directions (**1 : 1** mapping, giving both local and global IP addresses).
- 3 Map the other outgoing LAN traffic to IGA3 (**Many : 1** mapping).
- 4 You also map your third IGA to the web server and mail server on the LAN. Type **Server** allows you to specify multiple servers, of different types, to other computers behind NAT on the LAN.

The example situation looks somewhat like this:

Figure 336 NAT Example 3

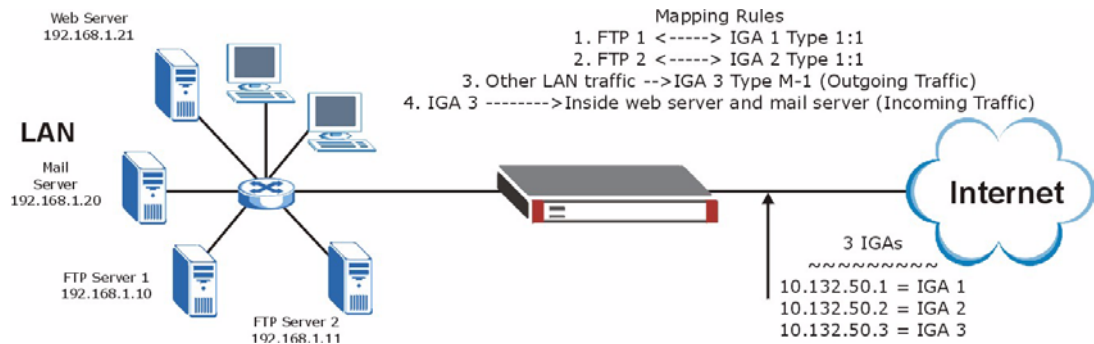

- 1 In this case you need to configure Address Mapping Set 1 from **Menu 15.1 - Address Mapping Sets**. Therefore you must choose the **Full Feature** option from the **Network Address Translation** field (in menu 4 or menu 11.3) in [Figure 337 on page 505](#).
- 2 Then enter 15 from the main menu.
- 3 Enter 1 to configure the Address Mapping Sets.
- 4 Enter 1 to begin configuring this new set. Enter a Set Name, choose the **Edit Action** and then enter 1 for the **Select Rule** field. Press [ENTER] to confirm.
- 5 Select **Type** as **One-to-One** (direct mapping for packets going both ways), and enter the local **Start IP** as 192.168.1.10 (the IP address of FTP Server 1), the global **Start IP** as 10.132.50.1 (our first IGA). (See [Figure 338 on page 506](#)).
- 6 Repeat the previous step for rules 2 to 4 as outlined above.
- 7 When finished, menu 15.1.1 should look like as shown in [Figure 339 on page 506](#).

Figure 337 Example 3: Menu 11.1.2

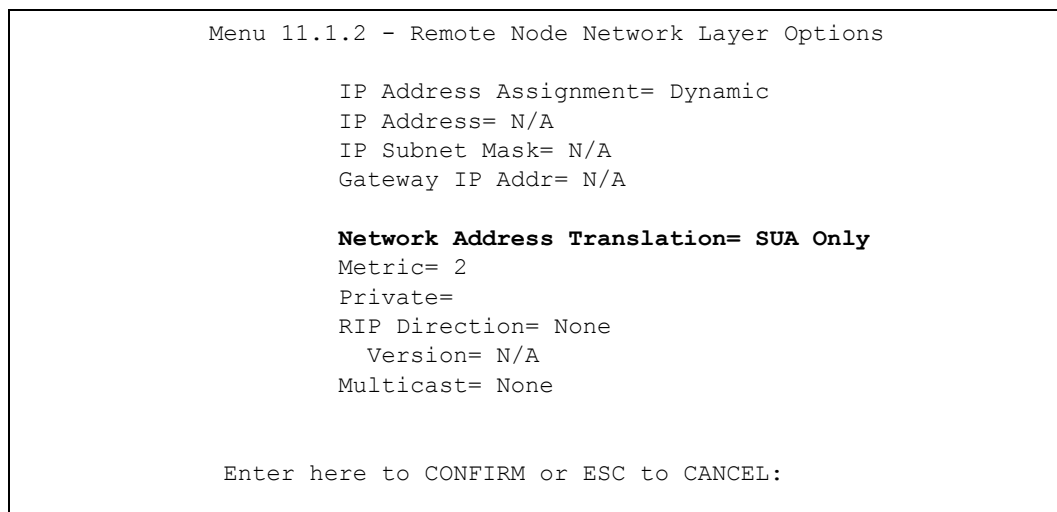

The following figure shows how to configure the first rule.

Figure 338 Example 3: Menu 15.1.1.1

```

Menu 15.1.1.1 Address Mapping Rule

Type= One-to-One

Local IP:
  Start= 192.168.1.10
  End  = N/A

Global IP:
  Start= 10.132.50.1
  End  = N/A

Server Mapping Set= N/A

Press ENTER to Confirm or ESC to Cancel:

```

Figure 339 Example 3: Final Menu 15.1.1

```

Menu 15.1.1 - Address Mapping Rules

Set Name= Example3

Idx  Local Start IP  Local End IP  Global Start IP  Global End IP  Type
-----
1.  192.168.1.10      10.132.50.1   1-1
2.  192.168.1.11      10.132.50.2   1-1
3.  0.0.0.0           255.255.255.255  10.132.50.3   M-1
4.                                     10.132.50.3   Server
5.
6.
7.
8.
9.
10.

Action= Edit      Select Rule=

Press ENTER to Confirm or ESC to Cancel:

```

Now configure the IGA3 to map to our web server and mail server on the LAN.

- 1 Enter 15 from the main menu.
- 2 Enter 2 to go to menu 15.2 and configure it as shown in [Figure 340 on page 507](#).

Figure 340 Example 3: Menu 15.2.

Menu 15.2 - NAT Server Setup				
Default Server: 0.0.0.0				
Rule	Act.	Start Port	End Port	IP Address
001	Yes	80	80	192.168.1.21
002	Yes	25	25	192.168.1.20
003	No	0	0	0.0.0.0
004	No	0	0	0.0.0.0
005	No	0	0	0.0.0.0
006	No	0	0	0.0.0.0
007	No	0	0	0.0.0.0
008	No	0	0	0.0.0.0
009	No	0	0	0.0.0.0
010	No	0	0	0.0.0.0

Select Command= None Select Rule= N/A
Press ENTER to Confirm or ESC to Cancel:

34.4.4 Example 4: NAT Unfriendly Application Programs

Some applications do not support NAT Mapping using TCP or UDP port address translation. In this case it is better to use **Many-One-to-One** mapping as port numbers do *not* change for **Many-One-to-One** (and **One-to-One**) NAT mapping types. The following figure illustrates this.

Figure 341 NAT Example 4

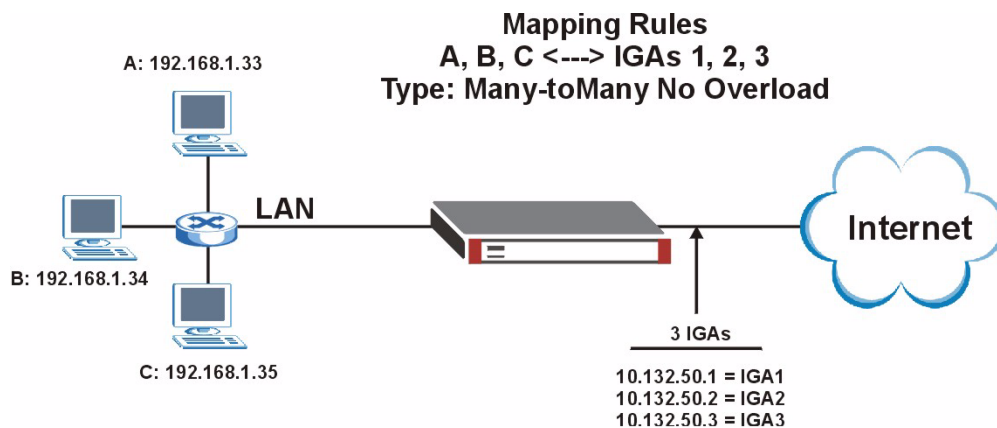

Other applications such as some gaming programs are NAT unfriendly because they embed addressing information in the data stream. These applications won't work through NAT even when using One-to-One and Many-One-to-One mapping types.

Follow the steps outlined in example 3 above to configure these two menus as follows.

Figure 342 Example 4: Menu 15.1.1.1: Address Mapping Rule

```

Menu 15.1.1.1 Address Mapping Rule

Type= Many-One-to-One

Local IP:
  Start= 192.168.1.10
  End  = 192.168.1.12

Global IP:
  Start= 10.132.50.1
  End  = 10.132.50.3

Press ENTER to Confirm or ESC to Cancel:
    
```

After you've configured your rule, you should be able to check the settings in menu 15.1.1 as shown next.

Figure 343 Example 4: Menu 15.1.1: Address Mapping Rules

```

Menu 15.1.1 - Address Mapping Rules

Set Name= Example4

Idx  Local Start IP  Local End IP  Global Start IP  Global End IP  Type
---  -
1.  192.168.1.10    192.168.1.12  10.132.50.1     10.132.50.3   M-1-1
2.
3.
4.
5.
6.
7.
8.
9.
10.

Action= Edit      Select Rule=

Press ENTER to Confirm or ESC to Cancel:
    
```

34.5 Trigger Port Forwarding

Some services use a dedicated range of ports on the client side and a dedicated range of ports on the server side. With regular port forwarding you set a forwarding port in NAT to forward a service (coming in from the server on the WAN) to the IP address of a computer on the client side (LAN). The problem is that port forwarding only forwards a service to a single LAN IP address. In order to use the same service on a different LAN computer, you have to manually replace the LAN computer's IP address in the forwarding port with another LAN computer's IP address.

Trigger port forwarding solves this problem by allowing computers on the LAN to dynamically take turns using the service. The ZyWALL records the IP address of a LAN computer that sends traffic to the WAN to request a service with a specific port number and protocol (a "trigger" port). When the ZyWALL's WAN port receives a response with a specific port number and protocol ("incoming" port), the ZyWALL forwards the traffic to the LAN IP address of the computer that sent the request. After that computer's connection for that service closes, another computer on the LAN can use the service in the same manner. This way you do not need to configure a new IP address each time you want a different LAN computer to use the application.

34.5.1 Two Points To Remember About Trigger Ports

- 1 Trigger events only happen on data that is going coming from inside the ZyWALL and going to the outside.
- 2 If an application needs a continuous data stream, that port (range) will be tied up so that another computer on the LAN can't trigger it.



Only one LAN computer can use a trigger port (range) at a time.

Enter 3 in menu 15 to display **Menu 15.3 - Trigger Ports** and configure trigger port rules for the WAN port.

Figure 344 Menu 15.3.1: Trigger Port Setup

Menu 15.3 - Trigger Port Setup					
Rule	Name	Incoming		Trigger	
		Start Port	End Port	Start Port	End Port
1.	Real Audio	6970	7170	7070	7070
2.		0	0	0	0
3.		0	0	0	0
4.		0	0	0	0
5.		0	0	0	0
6.		0	0	0	0
7.		0	0	0	0
8.		0	0	0	0
9.		0	0	0	0
10.		0	0	0	0
11.		0	0	0	0
12.		0	0	0	0

Press ENTER to Confirm or ESC to Cancel:

HTTP:80 FTP:21 Telnet:23 SMTP:25 POP3:110 PPTP:1723

The following table describes the fields in this menu.

Table 192 Menu 15.3: Trigger Port Setup

FIELD	DESCRIPTION
Rule	This is the rule index number.
Name	Enter a unique name for identification purposes. You may enter up to 15 characters in this field. All characters are permitted - including spaces.
Incoming	Incoming is a port (or a range of ports) that a server on the WAN uses when it sends out a particular service. The ZyWALL forwards the traffic with this port (or range of ports) to the client computer on the LAN that requested the service.
Start Port	Enter a port number or the starting port number in a range of port numbers.
End Port	Enter a port number or the ending port number in a range of port numbers.
Trigger	The trigger port is a port (or a range of ports) that causes (or triggers) the ZyWALL to record the IP address of the LAN computer that sent the traffic to a server on the WAN.
Start Port	Enter a port number or the starting port number in a range of port numbers.
End Port	Enter a port number or the ending port number in a range of port numbers.
Press [ENTER] at the message "Press ENTER to Confirm..." to save your configuration, or press [ESC] at any time to cancel.	

Introducing the ZyWALL Firewall

This chapter shows you how to get started with the ZyWALL firewall.

35.1 Using ZyWALL SMT Menus

From the main menu enter 21 to go to **Menu 21 - Filter Set and Firewall Configuration** to display the screen shown next.

Figure 345 Menu 21: Filter and Firewall Setup

```
Menu 21 - Filter and Firewall Setup

1. Filter Setup
2. Firewall Setup

Enter Menu Selection Number:
```

35.1.1 Activating the Firewall

Enter option 2 in this menu to bring up the following screen. Press [SPACE BAR] and then [ENTER] to select **Yes** in the **Active** field to activate the firewall. The firewall must be active to protect against Denial of Service (DoS) attacks. Use the web configurator to configure firewall rules.

Figure 346 Menu 21.2: Firewall Setup

```
Menu 21.2 - Firewall Setup

The firewall protects against Denial of Service (DoS) attacks when it is
active.

Your network is vulnerable to attacks when the firewall is turned off.

Refer to the User's Guide for details about the firewall default
policies.

You may define additional policy rules or modify existing ones but please
exercise extreme caution in doing so.

Active: Yes

You can use the Web Configurator to configure the firewall.

Press ENTER to Confirm or ESC to Cancel:
```



Configure the firewall rules using the web configurator or CLI commands.

Filter Configuration

This chapter shows you how to create and apply filters.

36.1 Introduction to Filters

Your ZyWALL uses filters to decide whether to allow passage of a data packet and/or to make a call. There are two types of filter applications: data filtering and call filtering. Filters are subdivided into device and protocol filters, which are discussed later.

Data filtering screens the data to determine if the packet should be allowed to pass. Data filters are divided into incoming and outgoing filters, depending on the direction of the packet relative to a port. Data filtering can be applied on either the WAN side or the LAN side. Call filtering is used to determine if a packet should be allowed to trigger a call. Remote node call filtering is only applicable when using PPPoE encapsulation. Outgoing packets must undergo data filtering before they encounter call filtering as shown in the following figure.

Figure 347 Outgoing Packet Filtering Process

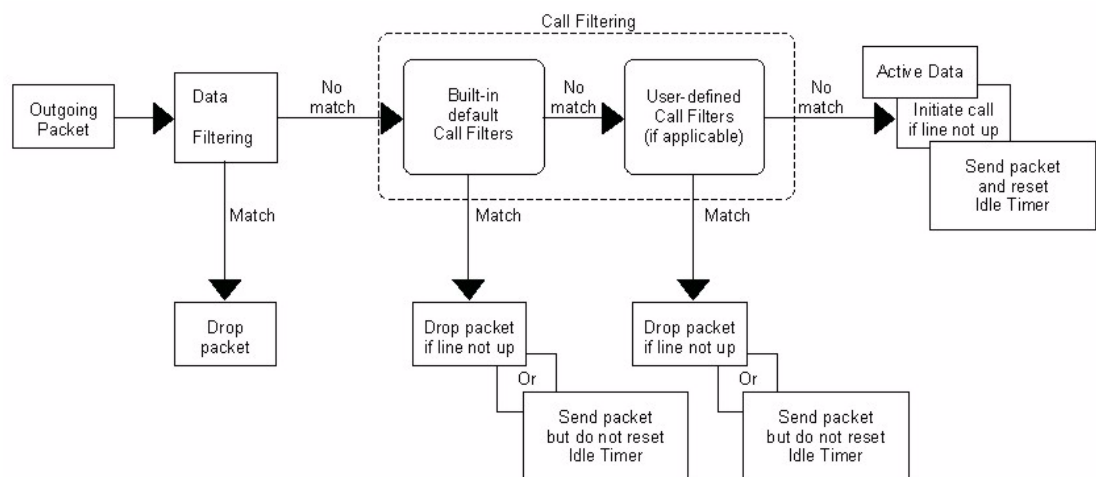

For incoming packets, your ZyWALL applies data filters only. Packets are processed depending upon whether a match is found. The following sections describe how to configure filter sets.

36.1.1 The Filter Structure of the ZyWALL

A filter set consists of one or more filter rules. Usually, you would group related rules, e.g., all the rules for NetBIOS, into a single set and give it a descriptive name. The ZyWALL allows you to configure up to twelve filter sets with six rules in each set, for a total of 72 filter rules in the system. You cannot mix device filter rules and protocol filter rules within the same set. You can apply up to four filter sets to a particular port to block multiple types of packets. With each filter set having up to six rules, you can have a maximum of 24 rules active for a single port.

Sets of factory default filter rules have been configured in menu 21 to prevent NetBIOS traffic from triggering calls and to prevent incoming telnet sessions. A summary of their filter rules is shown in the figures that follow.

The following figure illustrates the logic flow when executing a filter rule. See also [Figure 352 on page 520](#) for the logic flow when executing an IP filter.

Figure 348 Filter Rule Process

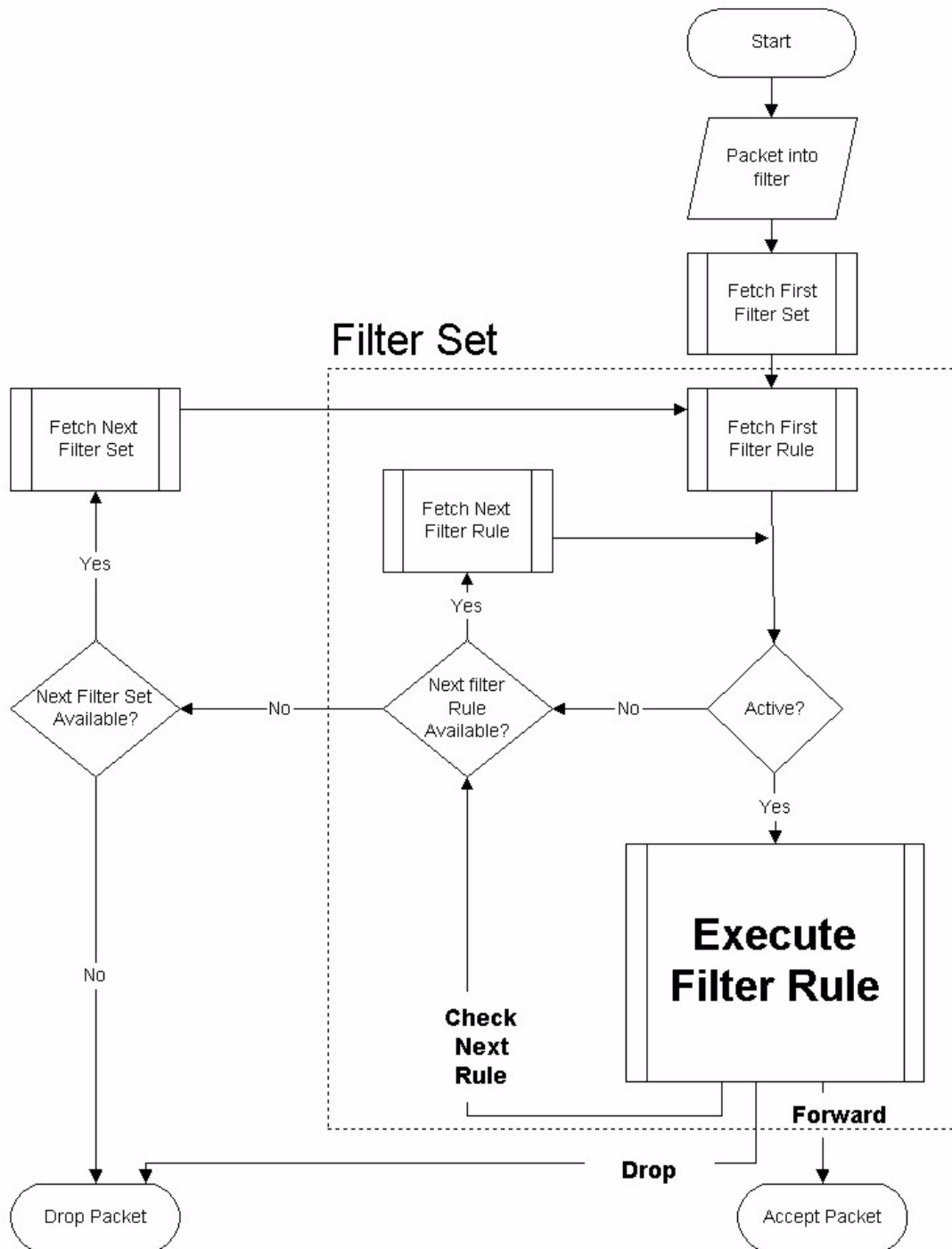

You can apply up to four filter sets to a particular port to block multiple types of packets. With each filter set having up to six rules, you can have a maximum of 24 rules active for a single port.

36.2 Configuring a Filter Set

The ZyWALL includes filtering for NetBIOS over TCP/IP packets by default. To configure another filter set, follow the procedure below.

- 1 Enter 21 in the main menu to open menu 21.

Figure 349 Menu 21: Filter and Firewall Setup

```

Menu 21 - Filter and Firewall Setup

      1. Filter Setup
      2. Firewall Setup

Enter Menu Selection Number:

```

- 2 Enter 1 to bring up the following menu.

Figure 350 Menu 21.1: Filter Set Configuration

```

Menu 21.1 - Filter Set Configuration

Filter Set #      Comments      Filter Set #      Comments
-----
1      _____      7      _____
2      _____      8      _____
3      _____      9      _____
4      _____     10     _____
5      _____     11     _____
6      _____     12     _____

Enter Filter Set Number to Configure= 0

Edit Comments= N/A

Press ENTER to Confirm or ESC to Cancel:

```

- 3 Select the filter set you wish to configure (1-12) and press [ENTER].
- 4 Enter a descriptive name or comment in the **Edit Comments** field and press [ENTER].
- 5 Press [ENTER] at the message [Press ENTER to confirm] to open **Menu 21.1.1 - Filter Rules Summary**.

This screen shows the summary of the existing rules in the filter set. The following tables contain a brief description of the abbreviations used in the previous menus.

Table 193 Abbreviations Used in the Filter Rules Summary Menu

FIELD	DESCRIPTION
A	Active: "Y" means the rule is active. "N" means the rule is inactive.
Type	The type of filter rule: "GEN" for Generic, "IP" for TCP/IP.
Filter Rules	These parameters are displayed here.
M	More. "Y" means there are more rules to check which form a rule chain with the present rule. An action cannot be taken until the rule chain is complete. "N" means there are no more rules to check. You can specify an action to be taken i.e., forward the packet, drop the packet or check the next rule. For the latter, the next rule is independent of the rule just checked.
m	Action Matched. "F" means to forward the packet immediately and skip checking the remaining rules. "D" means to drop the packet. "N" means to check the next rule.
n	Action Not Matched. "F" means to forward the packet immediately and skip checking the remaining rules. "D" means to drop the packet. "N" means to check the next rule.

The protocol dependent filter rules abbreviation are listed as follows:

Table 194 Rule Abbreviations Used

ABBREVIATION	DESCRIPTION
IP	
Pr	Protocol
SA	Source Address
SP	Source Port number
DA	Destination Address
DP	Destination Port number
GEN	
Off	Offset
Len	Length

Refer to the next section for information on configuring the filter rules.

36.2.1 Configuring a Filter Rule

To configure a filter rule, type its number in **Menu 21.1.1 - Filter Rules Summary** and press [ENTER] to open menu 21.1.1.1 for the rule.

To speed up filtering, all rules in a filter set must be of the same class, i.e., protocol filters or generic filters. The class of a filter set is determined by the first rule that you create. When applying the filter sets to a port, separate menu fields are provided for protocol and device filter sets. If you include a protocol filter set in a device filter field or vice versa, the ZyWALL will warn you and will not allow you to save.

36.2.2 Configuring a TCP/IP Filter Rule

This section shows you how to configure a TCP/IP filter rule. TCP/IP rules allow you to base the rule on the fields in the IP and the upper layer protocol, for example, UDP and TCP headers.

To configure TCP/IP rules, select **TCP/IP Filter Rule** from the **Filter Type** field and press [ENTER] to open **Menu 21.1.1.1 - TCP/IP Filter Rule**, as shown next.

Figure 351 Menu 21.1.1.1: TCP/IP Filter Rule

```

Menu 21.1.1.1 - TCP/IP Filter Rule

Filter #: 1,1
Filter Type= TCP/IP Filter Rule
Active= Yes
IP Protocol= 0      IP Source Route= No
Destination: IP Addr=
               IP Mask=
               Port #=
               Port # Comp= None
Source: IP Addr=
         IP Mask=
         Port #=
         Port # Comp= None
TCP Estab= N/A
More= No          Log= None
Action Matched= Check Next Rule
Action Not Matched= Check Next Rule

Press ENTER to Confirm or ESC to Cancel:

```

The following table describes how to configure your TCP/IP filter rule.

Table 195 Menu 21.1.1.1: TCP/IP Filter Rule

FIELD	DESCRIPTION
Active	Press [SPACE BAR] and then [ENTER] to select Yes to activate the filter rule or No to deactivate it.
IP Protocol	Protocol refers to the upper layer protocol, e.g., TCP is 6, UDP is 17 and ICMP is 1. Type a value between 0 and 255. A value of 0 matches ANY protocol.
IP Source Route	Press [SPACE BAR] and then [ENTER] to select Yes to apply the rule to packets with an IP source route option. Otherwise the packets must not have a source route option. The majority of IP packets do not have source route.
Destination	
IP Addr	Enter the destination IP Address of the packet you wish to filter. This field is ignored if it is 0.0.0.0.
IP Mask	Enter the IP mask to apply to the Destination: IP Addr .
Port #	Enter the destination port of the packets that you wish to filter. The range of this field is 0 to 65535. This field is ignored if it is 0.
Port # Comp	Press [SPACE BAR] and then [ENTER] to select the comparison to apply to the destination port in the packet against the value given in Destination: Port # . Options are None , Equal , Not Equal , Less and Greater .

Table 195 Menu 21.1.1.1: TCP/IP Filter Rule

FIELD	DESCRIPTION
Source	
IP Addr	Enter the source IP Address of the packet you wish to filter. This field is ignored if it is 0.0.0.0.
IP Mask	Enter the IP mask to apply to the Source: IP Addr .
Port #	Enter the source port of the packets that you wish to filter. The range of this field is 0 to 65535. This field is ignored if it is 0.
Port # Comp	Press [SPACE BAR] and then [ENTER] to select the comparison to apply to the source port in the packet against the value given in Source: Port # . Options are None , Equal , Not Equal , Less and Greater .
TCP Estab	This field is applicable only when the IP Protocol field is 6, TCP. Press [SPACE BAR] and then [ENTER] to select Yes , to have the rule match packets that want to establish a TCP connection (SYN=1 and ACK=0); if No , it is ignored.
More	Press [SPACE BAR] and then [ENTER] to select Yes or No . If Yes , a matching packet is passed to the next filter rule before an action is taken; if No , the packet is disposed of according to the action fields. If More is Yes , then Action Matched and Action Not Matched will be N/A .
Log	Press [SPACE BAR] and then [ENTER] to select a logging option from the following: None – No packets will be logged. Action Matched - Only packets that match the rule parameters will be logged. Action Not Matched - Only packets that do not match the rule parameters will be logged. Both – All packets will be logged.
Action Matched	Press [SPACE BAR] and then [ENTER] to select the action for a matching packet. Options are Check Next Rule , Forward and Drop .
Action Not Matched	Press [SPACE BAR] and then [ENTER] to select the action for a packet not matching the rule. Options are Check Next Rule , Forward and Drop .
When you have Menu 21.1.1.1 - TCP/IP Filter Rule configured, press [ENTER] at the message "Press ENTER to Confirm" to save your configuration, or press [ESC] to cancel. This data will now be displayed on Menu 21.1.1 - Filter Rules Summary .	

The following figure illustrates the logic flow of an IP filter.

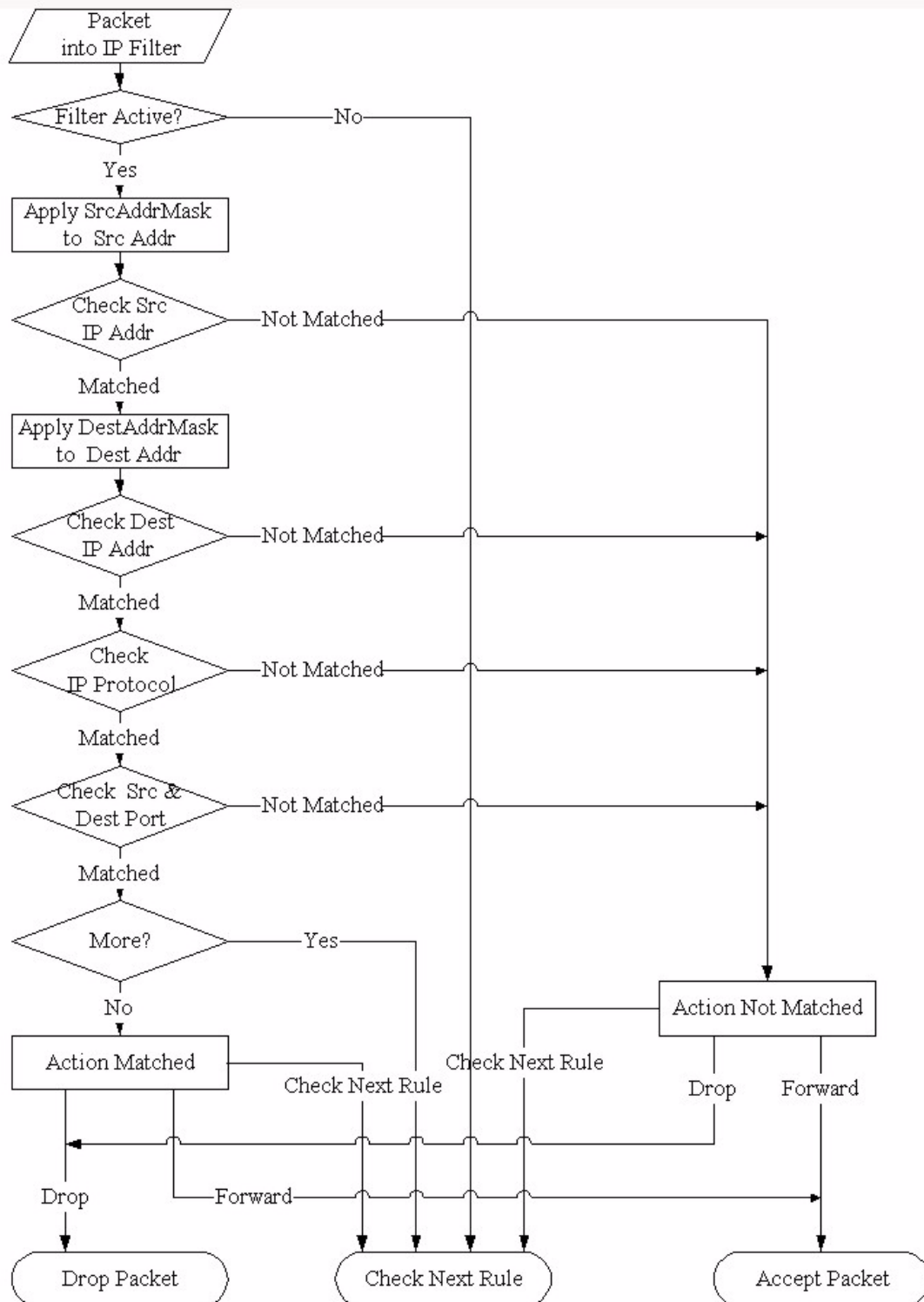
Figure 352 Executing an IP Filter

36.2.3 Configuring a Generic Filter Rule

This section shows you how to configure a generic filter rule. The purpose of generic rules is to allow you to filter non-IP packets. For IP, it is generally easier to use the IP rules directly.

For generic rules, the ZyWALL treats a packet as a byte stream as opposed to an IP or IPX packet. You specify the portion of the packet to check with the **Offset** (from 0) and the **Length** fields, both in bytes. The ZyWALL applies the Mask (bit-wise ANDing) to the data portion before comparing the result against the Value to determine a match. The **Mask** and **Value** are specified in hexadecimal numbers. Note that it takes two hexadecimal digits to represent a byte, so if the length is 4, the value in either field will take 8 digits, for example, FFFFFFFF.

To configure a generic rule, select **Generic Filter Rule** in the **Filter Type** field in menu 21.1.1.1 and press [ENTER] to open Generic Filter Rule, as shown below.

Figure 353 Menu 21.1.1.1: Generic Filter Rule

```

Menu 21.1.1.1 - Generic Filter Rule

Filter #: 1,1
Filter Type= Generic Filter Rule
Active= No
Offset= 0
Length= 0
Mask= N/A
Value= N/A
More= No           Log= None
Action Matched= Check Next Rule
Action Not Matched= Check Next Rule

Press ENTER to Confirm or ESC to Cancel:

```

The following table describes the fields in the **Generic Filter Rule** menu.

Table 196 Generic Filter Rule Menu Fields

FIELD	DESCRIPTION
Filter #	This is the filter set, filter rule co-ordinates, i.e., 2,3 refers to the second filter set and the third rule of that set.
Filter Type	Use [SPACE BAR] and then [ENTER] to select a rule type. Parameters displayed below each type will be different. TCP/IP filter rules are used to filter IP packets while generic filter rules allow filtering of non-IP packets. Options are Generic Filter Rule and TCP/IP Filter Rule .
Active	Select Yes to turn on the filter rule or No to turn it off.
Offset	Enter the starting byte of the data portion in the packet that you wish to compare. The range for this field is from 0 to 255.
Length	Enter the byte count of the data portion in the packet that you wish to compare. The range for this field is 0 to 8.
Mask	Enter the mask (in Hexadecimal notation) to apply to the data portion before comparison.
Value	Enter the value (in Hexadecimal notation) to compare with the data portion.
More	If Yes , a matching packet is passed to the next filter rule before an action is taken; else the packet is disposed of according to the action fields. If More is Yes , then Action Matched and Action Not Matched will be No .
Log	Select the logging option from the following: None - No packets will be logged. Action Matched - Only packets that match the rule parameters will be logged. Action Not Matched - Only packets that do not match the rule parameters will be logged. Both - All packets will be logged.

Table 196 Generic Filter Rule Menu Fields

FIELD	DESCRIPTION
Action Matched	Select the action for a packet matching the rule. Options are Check Next Rule , Forward and Drop .
Action Not Matched	Select the action for a packet not matching the rule. Options are Check Next Rule , Forward and Drop .
Once you have completed filling in Menu 21.1.1.1 - Generic Filter Rule , press [ENTER] at the message "Press ENTER to Confirm" to save your configuration, or press [ESC] to cancel. This data will now be displayed on Menu 21.1.1 - Filter Rules Summary .	

36.3 Example Filter

Let's look at an example to block outside users from accessing the ZyWALL via telnet. Please see our included disk for more example filters.

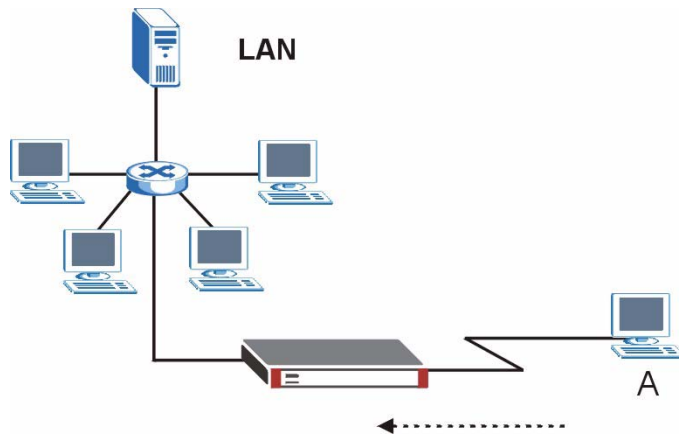
Figure 354 Telnet Filter Example

- 1 Enter 21 from the main menu to open **Menu 21 - Filter and Firewall Setup**.
- 2 Enter 1 to open Menu 21.1 - Filter Set Configuration.
- 3 Enter the index of the filter set you wish to configure (say 3) and press [ENTER].
- 4 Enter a descriptive name or comment in the **Edit Comments** field and press [ENTER].
- 5 Press [ENTER] at the message [Press ENTER to confirm] to open **Menu 21.1.3 - Filter Rules Summary**.
- 6 Enter 1 to configure the first filter rule (the only filter rule of this set). Make the entries in this menu as shown in the following figure.

Figure 355 Example Filter: Menu 21.1.3.1

```

Menu 21.1.3.1 - TCP/IP Filter Rule

Filter #: 3,1
Filter Type= TCP/IP Filter Rule
Active= Yes
IP Protocol= 6      IP Source Route= No
Destination: IP Addr= 0.0.0.0
              IP Mask= 0.0.0.0
              Port # = 23
              Port # Comp= Equal
Source: IP Addr= 0.0.0.0
        IP Mask= 0.0.0.0
        Port # = 0
        Port # Comp= None

TCP Estab= No
More= No          Log= None
Action Matched= Drop
Action Not Matched= Forward

Press ENTER to Confirm or ESC to Cancel:
Press Space Bar to Toggle.

```

The port number for the telnet service (TCP protocol) is **23**. See *RFC 1060* for port numbers of well-known services.

When you press [ENTER] to confirm, you will see the following screen. Note that there is only one filter rule in this set.

Figure 356 Example Filter Rules Summary: Menu 21.1.3

```

Menu 21.1.3 - Filter Rules Summary

# A Type          Filter Rules          M m n
- - - - -
1 Y IP   Pr=6, SA=0.0.0.0, DA=0.0.0.0, DP=23      N D F
2 N
3 N
4 N
5 N
6 N

Enter Filter Rule Number (1-6) to Configure: 1

```

This shows you that you have configured and activated (**A = Y**) a TCP/IP filter rule (**Type = IP, Pr = 6**) for destination telnet ports (**DP = 23**).

M = N means an action can be taken immediately. The action is to drop the packet (**m = D**) if the action is matched and to forward the packet immediately (**n = F**) if the action is not matched no matter whether there are more rules to be checked (there aren't in this example).

After you've created the filter set, you must apply it.

- 1 Enter 11 from the main menu to go to menu 11.
- 2 Enter 1 or 2 to open **Menu 11.x - Remote Node Profile**.
- 3 Go to the **Edit Filter Sets** field, press [SPACE BAR] to select **Yes** and press [ENTER].
- 4 This brings you to menu 11.1.4. Apply a filter set (our example filter set 3) as shown in [Figure 360 on page 527](#).
- 5 Press [ENTER] to confirm after you enter the set numbers and to leave menu 11.1.4.

36.4 Filter Types and NAT

There are two classes of filter rules, **Generic Filter** (Device) rules and protocol filter (**TCP/IP**) rules. Generic filter rules act on the raw data from/to LAN and WAN. Protocol filter rules act on the IP packets. Generic and TCP/IP filter rules are discussed in more detail in the next section. When NAT (Network Address Translation) is enabled, the inside IP address and port number are replaced on a connection-by-connection basis, which makes it impossible to know the exact address and port on the wire. Therefore, the ZyWALL applies the protocol filters to the “native” IP address and port number before NAT for outgoing packets and after NAT for incoming packets. On the other hand, the generic, or device filters are applied to the raw packets that appear on the wire. They are applied at the point when the ZyWALL is receiving and sending the packets; i.e. the interface. The interface can be an Ethernet port or any other hardware port. The following diagram illustrates this.

Figure 357 Protocol and Device Filter Sets

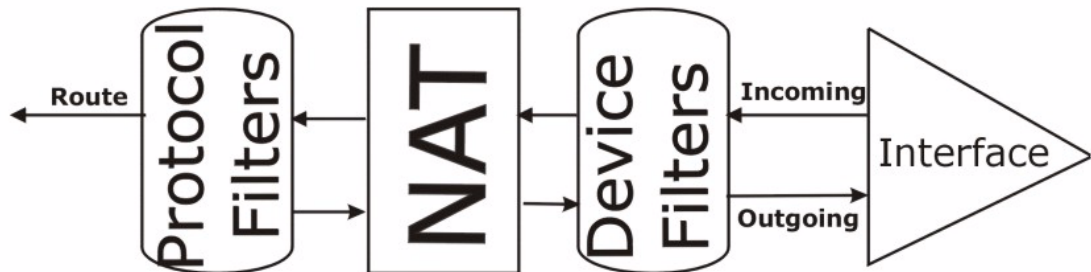

36.5 Firewall Versus Filters

Below are some comparisons between the ZyWALL's filtering and firewall functions.

36.5.1 Packet Filtering:

- The router filters packets as they pass through the router's interface according to the filter rules you designed.
- Packet filtering is a powerful tool, yet can be complex to configure and maintain, especially if you need a chain of rules to filter a service.
- Packet filtering only checks the header portion of an IP packet.

36.5.1.1 When To Use Filtering

- 1 To block/allow LAN packets by their MAC addresses.
- 2 To block/allow special IP packets which are neither TCP nor UDP, nor ICMP packets.
- 3 To block/allow both inbound (WAN to LAN) and outbound (LAN to WAN) traffic between the specific inside host/network "A" and outside host/network "B". If the filter blocks the traffic from A to B, it also blocks the traffic from B to A. Filters cannot distinguish traffic originating from an inside host or an outside host by IP address.
- 4 To block/allow IP trace route.

36.5.2 Firewall

- The firewall inspects packet contents as well as their source and destination addresses. Firewalls of this type employ an inspection module, applicable to all protocols, that understands data in the packet is intended for other layers, from the network layer (IP headers) up to the application layer.
- The firewall performs stateful inspection. It takes into account the state of connections it handles so that, for example, a legitimate incoming packet can be matched with the outbound request for that packet and allowed in. Conversely, an incoming packet masquerading as a response to a nonexistent outbound request can be blocked.
- The firewall uses session filtering, i.e., smart rules, that enhance the filtering process and control the network session rather than control individual packets in a session.
- The firewall provides e-mail service to notify you of routine reports and when alerts occur.

36.5.2.1 When To Use The Firewall

- 1 To prevent DoS attacks and prevent hackers cracking your network.
- 2 A range of source and destination IP addresses as well as port numbers can be specified within one firewall rule making the firewall a better choice when complex rules are required.
- 3 To selectively block/allow inbound or outbound traffic between inside host/networks and outside host/networks. Remember that filters cannot distinguish traffic originating from an inside host or an outside host by IP address.
- 4 The firewall performs better than filtering if you need to check many rules.
- 5 Use the firewall if you need routine e-mail reports about your system or need to be alerted when attacks occur.
- 6 The firewall can block specific URL traffic that might occur in the future. The URL can be saved in an Access Control List (ACL) database.

36.6 Applying a Filter

This section shows you where to apply the filter(s) after you design it (them). The ZyWALL already has filters to prevent NetBIOS traffic from triggering calls, and block incoming telnet, FTP and HTTP connections.



If you do not activate the firewall, it is advisable to apply filters.

36.6.1 Applying LAN Filters

LAN traffic filter sets may be useful to block certain packets, reduce traffic and prevent security breaches. Go to menu 3.1 (shown next) and enter the number(s) of the filter set(s) that you want to apply as appropriate. You can choose up to four filter sets (from twelve) by entering their numbers separated by commas, e.g., 3, 4, 6, 11. Input filter sets filter incoming traffic to the ZyWALL and output filter sets filter outgoing traffic from the ZyWALL. For PPPoE or PPTP encapsulation, you have the additional option of specifying remote node call filter sets.

Figure 358 Filtering LAN Traffic

```

Menu 3.1 - LAN Port Filter Setup

Input Filter Sets:
  protocol filters=
  device filters=
Output Filter Sets:
  protocol filters=
  device filters=

Press ENTER to Confirm or ESC to Cancel:

```

36.6.2 Applying DMZ Filters

DMZ traffic filter sets may be useful to block certain packets, reduce traffic and prevent security breaches. Go to menu 5.1 (shown next) and enter the number(s) of the filter set(s) that you want to apply as appropriate. You can choose up to four filter sets (from twelve) by entering their numbers separated by commas, e.g., 3, 4, 6, 11. Input filter sets filter incoming traffic to the ZyWALL and output filter sets filter outgoing traffic from the ZyWALL. The ZyWALL already has filters to prevent NetBIOS traffic from triggering calls, and block incoming telnet, FTP and HTTP connections.

Figure 359 Filtering DMZ Traffic

```

Menu 5.1 - DMZ Port Filter Setup

Input Filter Sets:
  protocol filters=
  device filters=
Output Filter Sets:
  protocol filters=
  device filters=

Press ENTER to Confirm or ESC to Cancel:

```

36.6.3 Applying Remote Node Filters

Go to menu 11.1.4 (shown below – note that call filter sets are only present for PPPoE encapsulation) and enter the number(s) of the filter set(s) as appropriate. You can cascade up to four filter sets by entering their numbers separated by commas. The ZyWALL already has filters to prevent NetBIOS traffic from triggering calls, and block incoming telnet, FTP and HTTP connections.

Figure 360 Filtering Remote Node Traffic

```
Menu 11.1.4 - Remote Node Filter Setup

Input Filter Sets:
  protocol filters=
  device filters=
Output Filter Sets:
  protocol filters=
  device filters=

Press ENTER to Confirm or ESC to Cancel:
```

SNMP Configuration

This chapter explains SNMP configuration menu 22.

37.1 SNMP Configuration

To configure SNMP, enter 22 from the main menu to display **Menu 22 - SNMP Configuration** as shown next. The “community” for **Get**, **Set** and **Trap** fields is SNMP terminology for password.

Figure 361 Menu 22: SNMP Configuration

```

Menu 22 - SNMP Configuration

SNMP:
  Get Community= public
  Set Community= public
  Trusted Host= 0.0.0.0
Trap:
  Community= public
  Destination= 0.0.0.0

Press ENTER to Confirm or ESC to Cancel:

```

The following table describes the SNMP configuration parameters.

Table 197 SNMP Configuration Menu Fields

FIELD	DESCRIPTION
Get Community	Type the Get community, which is the password for the incoming Get- and GetNext requests from the management station.
Set Community	Type the Set community, which is the password for incoming Set requests from the management station.
Trusted Host	If you enter a trusted host, your ZyWALL will only respond to SNMP messages from this address. A blank (default) field means your ZyWALL will respond to all SNMP messages it receives, regardless of source.
Trap	
Community	Type the Trap community, which is the password sent with each trap to the SNMP manager.

Table 197 SNMP Configuration Menu Fields (continued)

FIELD	DESCRIPTION
Destination	Type the IP address of the station to send your SNMP traps to.
When you have completed this menu, press [ENTER] at the prompt "Press [ENTER] to confirm or [ESC] to cancel" to save your configuration or press [ESC] to cancel and go back to the previous screen.	

37.2 SNMP Traps

The ZyWALL will send traps to the SNMP manager when any one of the following events occurs:

Table 198 SNMP Traps

TRAP #	TRAP NAME	DESCRIPTION
0	coldStart (defined in <i>RFC-1215</i>)	A trap is sent after booting (power on).
1	warmStart (defined in <i>RFC-1215</i>)	A trap is sent after booting (software reboot).
4	authenticationFailure (defined in <i>RFC-1215</i>)	A trap is sent to the manager when receiving any SNMP get or set requirements with the wrong community (password).
6	whyReboot (defined in ZYXEL-MIB)	A trap is sent with the reason of restart before rebooting when the system is going to restart (warm start).
6a	For intentional reboot:	A trap is sent with the message "System reboot by user!" if reboot is done intentionally, (for example, download new files, CLI command "sys reboot", etc.).
6b	For fatal error:	A trap is sent with the message of the fatal code if the system reboots because of fatal errors.

System Information & Diagnosis

This chapter covers SMT menus 24.1 to 24.4.

38.1 Introduction to System Status

This chapter covers the diagnostic tools that help you to maintain your ZyWALL. These tools include updates on system status, port status and log and trace capabilities.

Select menu 24 in the main menu to open **Menu 24 - System Maintenance**, as shown below.

Figure 362 Menu 24: System Maintenance

```
Menu 24 - System Maintenance

1. System Status
2. System Information and Console Port Speed
3. Log and Trace
4. Diagnostic
5. Backup Configuration
6. Restore Configuration
7. Upload Firmware
8. Command Interpreter Mode
9. Call Control
10. Time and Date Setting
11. Remote Management Setup

Enter Menu Selection Number:
```

38.2 System Status

The first selection, System Status, gives you information on the version of your system firmware and the status and statistics of the ports, as shown in the next figure. System Status is a tool that can be used to monitor your ZyWALL. Specifically, it gives you information on your system firmware version, number of packets sent and number of packets received.

To get to the System Status:

- 1 Enter number 24 to go to Menu 24 - System Maintenance.
- 2 In this menu, enter 1 to open System Maintenance - Status.

- 3 There are three commands in **Menu 24.1 - System Maintenance - Status**. Entering 1 drops the WAN connection, 9 resets the counters and [ESC] takes you back to the previous screen.

Figure 363 Menu 24.1: System Maintenance: Status

```

Menu 24.1 - System Maintenance - Status                                07:34:20
                                                                    Mon. Sep. 04, 2006

Port  Status      TxPkts    RxPkts    Cols     Tx B/s    Rx B/s    Up Time
WAN   100M/Full    4860      17092     0         0         128      1:47:08
LAN   100M/Full    9021      10280     0         716      128      1:50:12
DMZ   100M/Full    229       0         0         0         0        1:50:12
WLAN  100M/Full    108       0         0         0         0        1:50:12

Port  Ethernet Address      IP Address      IP Mask      DHCP
WAN   00:13:49:00:00:02    172.23.37.34   255.255.255.0 Client
LAN   00:13:49:00:00:01    192.168.1.1    255.255.255.0 Server
WLAN  00:13:49:00:00:04    0.0.0.0        0.0.0.0      None
DMZ   00:13:49:00:00:03    10.2.3.4       255.0.0.0    None

System up Time:      1:50:17

Press Command:

COMMANDS: 1-Drop WAN 9-Reset Counters  ESC-Exit

```

The following table describes the fields present in **Menu 24.1 - System Maintenance - Status**. These fields are READ-ONLY and meant for diagnostic purposes. The upper right corner of the screen shows the time and date according to the format you set in menu 24.10.

Table 199 System Maintenance: Status Menu Fields

FIELD	DESCRIPTION
Port	This field identifies a port (WAN, LAN, DMZ or WLAN) on the ZyWALL.
Status	For the LAN, DMZ, and WLAN Interfaces, this displays the port speed and duplex setting. For the WAN port, it displays the port speed and duplex setting if you're using Ethernet encapsulation and Down (line is down or not connected), Idle (line (ppp) idle), Dial (starting to trigger a call) or Drop (dropping a call) if you're using PPPoE encapsulation.
TxPkts	This is the number of transmitted packets on this port.
RxPkts	This is the number of received packets on this port.
Cols	This is the number of collisions on this port.
Tx B/s	This field shows the transmission speed in Bytes per second on this port.
Rx B/s	This field shows the reception speed in Bytes per second on this port.
Up Time	This is the total amount of time the line has been up.
Ethernet Address	This is the MAC address of the port listed on the left.
IP Address	This is the IP address of the port listed on the left.
IP Mask	This is the IP mask of the port listed on the left.

Table 199 System Maintenance: Status Menu Fields (continued)

FIELD	DESCRIPTION
DHCP	This is the DHCP setting of the port listed on the left.
System up Time	This is the total time the ZyWALL has been on.
You may enter 1 to drop the WAN connection, 9 to reset the counters or [ESC] to return to menu 24.	

38.3 System Information and Console Port Speed

This section describes your system and allows you to choose different console port speeds. To get to the System Information and Console Port Speed:

- 1 Enter 24 to go to **Menu 24 - System Maintenance**.
- 2 Enter 2 to open **Menu 24.2 - System Information and Console Port Speed**.
- 3 From this menu you have two choices as shown in the next figure:

Figure 364 Menu 24.2: System Information and Console Port Speed

```

Menu 24.2 - System Information and Console Port Speed

    1. System Information
    2. Console Port Speed

Please enter selection:

```

38.3.1 System Information

System Information gives you information about your system as shown below. More specifically, it gives you information on your routing protocol, Ethernet address, IP address, etc.

Figure 365 Menu 24.2.1: System Maintenance: Information

```

Menu 24.2.1 - System Maintenance - Information

Name: zy2.zyxel.com
Routing: IP
ZyNOS F/W Version: V4.01(XU.0)b1 | 08/08/2006
Country Code: 255

LAN
Ethernet Address: 00:13:49:00:00:01
IP Address: 192.168.1.1
IP Mask: 255.255.255.0
DHCP: Server

Press ESC or RETURN to Exit:

```

The following table describes the fields in this screen.

Table 200 Fields in System Maintenance: Information

FIELD	DESCRIPTION
Name	This is the ZyWALL's system name + domain name assigned in menu 1. For example, System Name= xxx; Domain Name= baboo.mickey.com Name= xxx.baboo.mickey.com
Routing	Refers to the routing protocol used.
ZyNOS F/W Version	Refers to the version of ZyXEL's Network Operating System software.
Country Code	Refers to the country code of the firmware.
LAN	
Ethernet Address	Refers to the Ethernet MAC (Media Access Control) address of your ZyWALL.
IP Address	This is the IP address of the ZyWALL in dotted decimal notation.
IP Mask	This shows the IP mask of the ZyWALL.
DHCP	This field shows the DHCP setting of the ZyWALL.
When finished viewing, press [ESC] or [ENTER] to exit.	

38.3.2 Console Port Speed

You can change the speed of the console port through **Menu 24.2.2 – Console Port Speed**. Your ZyWALL supports 9600 (default), 19200, 38400, 57600, and 115200 bps for the console port. Press [SPACE BAR] and then [ENTER] to select the desired speed in menu 24.2.2, as shown next.

Figure 366 Menu 24.2.2: System Maintenance: Change Console Port Speed

Menu 24.2.2 - System Maintenance - Change Console Port Speed
Console Port Speed: 9600
Press ENTER to Confirm or ESC to Cancel: Press Space Bar to Toggle.

38.4 Log and Trace

There are two logging facilities in the ZyWALL. The first is the error logs and trace records that are stored locally. The second is the UNIX syslog facility for message logging.

38.4.1 Viewing Error Log

The first place you should look for clues when something goes wrong is the error/trace log. Follow the procedure below to view the local error/trace log:

- 1 Select option 24 from the main menu to open **Menu 24 - System Maintenance**.
- 2 From menu 24, select option 3 to open **Menu 24.3 - System Maintenance - Log and Trace**.

- 3 Select the first option from **Menu 24.3 - System Maintenance - Log and Trace** to display the error log in the system.

After the ZyWALL finishes displaying, you will have the option to clear the error log.

Figure 367 Menu 24.3: System Maintenance: Log and Trace

```

Menu 24.3 - System Maintenance - Log and Trace

1. View Error Log
2. UNIX Syslog

4. Call-Triggering Packet

Please enter selection

```

Examples of typical error and information messages are presented in the following figure.

Figure 368 Examples of Error and Information Messages

```

52 Thu Jul 1 05:54:53 2004 PP05 ERROR Wireless LAN init fail, code=15
53 Thu Jul 1 05:54:53 2004 PINI INFO Channel 0 ok
54 Thu Jul 1 05:54:56 2004 PP05 -WARN SNMP TRAP 3: interface 3: link up
55 Thu Jul 1 05:54:56 2004 PP0d INFO LAN promiscuous mode <0>
57 Thu Jul 1 05:54:56 2004 PP0d INFO LAN promiscuous mode <1>
58 Thu Jul 1 05:54:56 2004 PINI INFO Last errorlog repeat 1 Times
59 Thu Jul 1 05:54:56 2004 PINI INFO main: init completed
60 Thu Jul 1 05:55:26 2004 PSSV -WARN SNMP TRAP 0: cold start
61 Thu Jul 1 05:56:56 2004 PINI INFO SMT Session Begin
62 Thu Jul 1 07:50:58 2004 PINI INFO SMT Session End
63 Thu Jul 1 07:53:28 2004 PINI INFO SMT Session Begin
Clear Error Log (y/n):

```

38.4.2 Syslog Logging

The ZyWALL uses the syslog facility to log the CDR (Call Detail Record) and system messages to a syslog server. Syslog and accounting can be configured in **Menu 24.3.2 - System Maintenance - Syslog Logging**, as shown next.

Figure 369 Menu 24.3.2: System Maintenance: Syslog Logging

```

Menu 24.3.2 - System Maintenance - Syslog Logging

Syslog:
Active= No
Syslog Server IP Address= 0.0.0.0
Log Facility= Local 1

Press ENTER to Confirm or ESC to Cancel:

```

You need to configure the syslog parameters described in the following table to activate syslog then choose what you want to log.

Table 201 System Maintenance Menu Syslog Parameters

FIELD	DESCRIPTION
Syslog:	
Active	Press [SPACE BAR] and then [ENTER] to turn syslog on or off.
Syslog Server IP Address	Enter the server name or IP address of the syslog server that will log the selected categories of logs.
Log Facility	Press [SPACE BAR] and then [ENTER] to select a location. The log facility allows you to log the messages to different files in the syslog server. Refer to the documentation of your syslog program for more details.
When finished configuring this screen, press [ENTER] to confirm or [ESC] to cancel.	

Your ZyWALL sends five types of syslog messages. Some examples (not all ZyWALL specific) of these syslog messages with their message formats are shown next:

1 CDR

CDR Message Format
<pre>SdcmSyslogSend(SYSLOG_CDR, SYSLOG_INFO, String); String = board xx line xx channel xx, call xx, str board = the hardware board ID line = the WAN ID in a board Channel = channel ID within the WAN call = the call reference number which starts from 1 and increments by 1 for each new call str = C01 Outgoing Call dev xx ch xx (dev:device No. ch:channel No.) L02 Tunnel Connected(L2TP) C02 OutCall Connected xxxx (means connected speed) xxxxx (means Remote Call Number) L02 Call Terminated C02 Call Terminated Jul 19 11:19:27 192.168.102.2 ZyXEL: board 0 line 0 channel 0, call 1, C01 Outgoing Call dev=2 ch=0 40002 Jul 19 11:19:32 192.168.102.2 ZyXEL: board 0 line 0 channel 0, call 1, C02 OutCall Connected 64000 40002 Jul 19 11:20:06 192.168.102.2 ZyXEL: board 0 line 0 channel 0, call 1, C02 Call Terminated</pre>

2 Packet triggered

Packet triggered Message Format
<pre>SdcmSyslogSend(SYSLOG_PKTTRI, SYSLOG_NOTICE, String); String = Packet trigger: Protocol=xx Data=xxxxxxxxx.....x Protocol: (1:IP 2:IPX 3:IPXHC 4:BPDU 5:ATALK 6:IPNG) Data: We will send forty-eight Hex characters to the server Jul 19 11:28:39 192.168.102.2 ZyXEL: Packet Trigger: Protocol=1, Data=4500003c100100001f010004c0a86614ca849a7b08004a5c02000100616263646566676869 6a6b6c6d6e6f7071727374 Jul 19 11:28:56 192.168.102.2 ZyXEL: Packet Trigger: Protocol=1, Data=4500002c1b0140001f06b50ec0a86614ca849a7b0427001700195b3e00000000600220008c d40000020405b4 Jul 19 11:29:06 192.168.102.2 ZyXEL: Packet Trigger: Protocol=1, Data=45000028240140001f06ac12c0a86614ca849a7b0427001700195b451d143013500400007 7600000</pre>

3 Filter log

Filter log Message Format
<pre>SdcmSyslogSend(SYSLOG_FILLOG, SYSLOG_NOTICE, String); String = IP[Src=xx.xx.xx.xx Dst=xx.xx.xx.xx prot spo=xxxx dpo=xxxx] S04>R01mD IP[...] is the packet header and S04>R01mD means filter set 4 (S) and rule 1 (R), match (m) drop (D). Src: Source Address Dst: Destination Address prot: Protocol ("TCP","UDP","ICMP") spo: Source port dpo: Destination port Mar 03 10:39:43 202.132.155.97 ZyXEL: GEN[ffffffffnordff0080] }S05>R01mF Mar 03 10:41:29 202.132.155.97 ZyXEL: GEN[00a0c5f502fnord010080] }S05>R01mF Mar 03 10:41:34 202.132.155.97 ZyXEL: IP[Src=192.168.2.33 Dst=202.132.155.93 ICMP]}S04>R01mF Mar 03 11:59:20 202.132.155.97 ZyXEL: GEN[00a0c5f502fnord010080] }S05>R01mF Mar 03 12:00:52 202.132.155.97 ZyXEL: GEN[ffffffff0080] }S05>R01mF Mar 03 12:00:57 202.132.155.97 ZyXEL: GEN[00a0c5f502010080] }S05>R01mF Mar 03 12:01:06 202.132.155.97 ZyXEL: IP[Src=192.168.2.33 Dst=202.132.155.93 TCP spo=01170 dpo=00021]}S04>R01mF</pre>

4 PPP log

PPP Log Message Format
<pre>SdcmSyslogSend(SYSLOG_PPLOG, SYSLOG_NOTICE, String); String = ppp:Proto Starting / ppp:Proto Opening / ppp:Proto Closing / ppp:Proto Shutdown Proto = LCP / ATCP / BACP / BCP / CBCP / CCP / CHAP/ PAP / IPCP / IPXCP Jul 19 11:42:44 192.168.102.2 ZyXEL: ppp:LCP Closing Jul 19 11:42:49 192.168.102.2 ZyXEL: ppp:IPCP Closing Jul 19 11:42:54 192.168.102.2 ZyXEL: ppp:CCP Closing</pre>

5 Firewall log

Firewall Log Message Format
<pre>SdcmSyslogSend(SYSLOG_FIREWALL, SYSLOG_NOTICE, buf); buf = IP[Src=xx.xx.xx.xx : spo=xxxx Dst=xx.xx.xx.xx : dpo=xxxx prot rule action] Src: Source Address spo: Source port (empty means no source port information) Dst: Destination Address dpo: Destination port (empty means no destination port information) prot: Protocol ("TCP","UDP","ICMP", "IGMP", "GRE", "ESP") rule: <a,b> where a means "set" number; b means "rule" number. Action: nothing(N) block (B) forward (F) 08-01-200011:48:41Local1.Notice192.168.10.10RAS: FW 172.21.1.80 :137 ->172.21.1.80 :137 UDP default permit:<2,0> B 08-01-200011:48:41Local1.Notice192.168.10.10RAS: FW 192.168.77.88 :520 ->192.168.77.88 :520 UDP default permit:<2,0> B 08-01-200011:48:39Local1.Notice192.168.10.10RAS: FW 172.21.1.50 ->172.21.1.50 IGMP<2> default permit:<2,0> B 08-01-200011:48:39Local1.Notice192.168.10.10RAS: FW 172.21.1.25 ->172.21.1.25 IGMP<2> default permit:<2,0> B</pre>

38.4.3 Call-Triggering Packet

Call-Triggering Packet displays information about the packet that triggered a dial-out call in an easy readable format. Equivalent information is available in menu 24.1 in hex format. An example is shown next.

Figure 370 Call-Triggering Packet Example

```

IP Frame: ENETO-RECV Size: 44/ 44   Time: 17:02:44.262
Frame Type:

  IP Header:
    IP Version           = 4
    Header Length        = 20
    Type of Service      = 0x00 (0)
    Total Length         = 0x002C (44)
    Identification      = 0x0002 (2)
    Flags                = 0x00
    Fragment Offset     = 0x00
    Time to Live         = 0xFE (254)
    Protocol             = 0x06 (TCP)
    Header Checksum      = 0xFB20 (64288)
    Source IP           = 0xC0A80101 (192.168.1.1)
    Destination IP      = 0x00000000 (0.0.0.0)

  TCP Header:
    Source Port          = 0x0401 (1025)
    Destination Port    = 0x000D (13)
    Sequence Number     = 0x05B8D000 (95997952)
    Ack Number          = 0x00000000 (0)
    Header Length        = 24
    Flags                = 0x02 (....S.)
    Window Size         = 0x2000 (8192)
    Checksum            = 0xE06A (57450)
    Urgent Ptr          = 0x0000 (0)
    Options              =
      0000: 02 04 02 00

  RAW DATA:
    0000: 45 00 00 2C 00 02 00 00-FE 06 FB 20 C0 A8 01 01  E.....
    0010: 00 00 00 00 04 01 00 0D-05 B8 D0 00 00 00 00 00
    .....
    0020: 60 02 20 00 E0 6A 00 00-02 04 02 00
  Press any key to continue...

```

38.5 Diagnostic

The diagnostic facility allows you to test the different aspects of your ZyWALL to determine if it is working properly. Menu 24.4 allows you to choose among various types of diagnostic tests to evaluate your system, as shown next. Not all fields are available on all models.

Follow the procedure below to get to **Menu 24.4 - System Maintenance - Diagnostic**.

- 1** From the main menu, select option 24 to open **Menu 24 - System Maintenance**.
- 2** From this menu, select option 4. Diagnostic. This will open **Menu 24.4 - System Maintenance - Diagnostic**.

Figure 371 Menu 24.4: System Maintenance: Diagnostic

```

Menu 24.4 - System Maintenance - Diagnostic

TCP/IP
  1. Ping Host
  2. WAN DHCP Release
  3. WAN DHCP Renewal
  4. PPPoE/PPTP Setup Test

System
  11. Reboot System

Enter Menu Selection Number:

Host IP Address= N/A

```

38.5.1 WAN DHCP

DHCP functionality can be enabled on the LAN, DMZ, WLAN or WAN as shown in [Figure 372 on page 540](#). LAN DHCP has already been discussed. The ZyWALL can act either as a WAN DHCP client (**IP Address Assignment** field in menu 4 or menu 11.x.2 is **Dynamic** and the **Encapsulation** field in menu 4 or menu 11 is **Ethernet**) or **None**, (when you have a static IP). The **WAN Release** and **Renewal** fields in menu 24.4 conveniently allow you to release and/or renew the assigned WAN IP address, subnet mask and default gateway in a fashion similar to winipcfg.

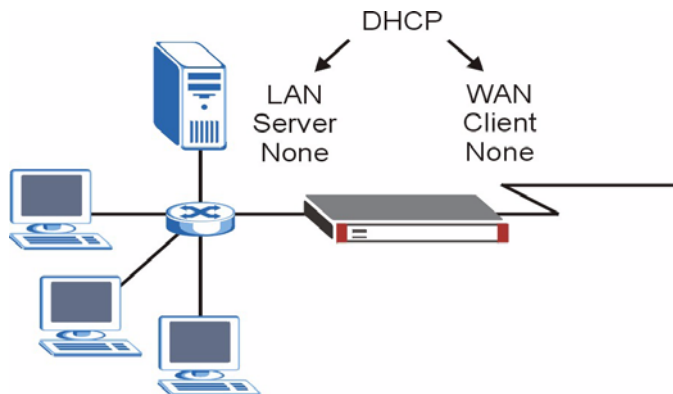
Figure 372 WAN & LAN DHCP

The following table describes the diagnostic tests available in menu 24.4 for your ZyWALL and associated connections.

Table 202 System Maintenance Menu Diagnostic

FIELD	DESCRIPTION
Ping Host	Enter 1 to ping any machine (with an IP address) on your LAN, DMZ, WLAN or WAN. Enter its IP address in the Host IP Address field below.
WAN DHCP Release	Enter 2 to release your WAN DHCP settings.
WAN DHCP Renewal	Enter 3 to renew your WAN DHCP settings.

Table 202 System Maintenance Menu Diagnostic

FIELD	DESCRIPTION
PPPoE/PPTP Setup Test	Enter 4 to test the Internet setup. You can also test the Internet setup in Menu 4 - Internet Access . Please refer to Chapter 30 on page 473 for more details. This feature is only available for dial-up connections using PPPoE or PPTP encapsulation.
Reboot System	Enter 11 to reboot the ZyWALL.
Host IP Address	If you entered 1 in the Enter Menu Selection Number field, then enter the IP address of the computer you want to ping in this field.
Enter the number of the selection you would like to perform or press [ESC] to cancel.	

Firmware and Configuration File Maintenance

This chapter tells you how to back up and restore your configuration file as well as upload new firmware and a new configuration file.

39.1 Introduction

Use the instructions in this chapter to change the ZyWALL's configuration file or upgrade its firmware. After you configure your ZyWALL, you can backup the configuration file to a computer. That way if you later misconfigure the ZyWALL, you can upload the backed up configuration file to return to your previous settings. You can alternately upload the factory default configuration file if you want to return the ZyWALL to the original default settings. The firmware determines the ZyWALL's available features and functionality. You can download new firmware releases from your nearest ZyXEL FTP site to use to upgrade your ZyWALL's performance.

39.2 Filename Conventions

The configuration file (often called the romfile or rom-0) contains the factory default settings in the menus such as password, DHCP Setup, TCP/IP Setup, etc. It arrives from ZyXEL with a "rom" filename extension. Once you have customized the ZyWALL's settings, they can be saved back to your computer under a filename of your choosing.

ZyNOS (ZyXEL Network Operating System sometimes referred to as the "ras" file) is the system firmware and has a "bin" filename extension. With many FTP and TFTP clients, the filenames are similar to those seen next.

```
ftp> put firmware.bin ras
```

This is a sample FTP session showing the transfer of the computer file " firmware.bin" to the ZyWALL.

```
ftp> get rom-0 config.cfg
```

This is a sample FTP session saving the current configuration to the computer file "config.cfg".

If your (T)FTP client does not allow you to have a destination filename different than the source, you will need to rename them as the ZyWALL only recognizes "rom-0" and "ras". Be sure you keep unaltered copies of both files for later use.

The following table is a summary. Please note that the internal filename refers to the filename on the ZyWALL and the external filename refers to the filename not on the ZyWALL, that is, on your computer, local network or FTP site and so the name (but not the extension) may vary. After uploading new firmware, see the **ZyNOS F/W Version** field in **Menu 24.2.1 - System Maintenance - Information** to confirm that you have uploaded the correct firmware version. The AT command is the command you enter after you press “y” when prompted in the SMT menu to go into debug mode.

Table 203 Filename Conventions

FILE TYPE	INTERNAL NAME	EXTERNAL NAME	DESCRIPTION
Configuration File	Rom-0	This is the configuration filename on the ZyWALL. Uploading the rom-0 file replaces the entire ROM file system, including your ZyWALL configurations, system-related data (including the default password), the error log and the trace log.	*.rom
Firmware	Ras	This is the generic name for the ZyNOS firmware on the ZyWALL.	*.bin

39.3 Backup Configuration



The ZyWALL displays different messages explaining different ways to backup, restore and upload files in menus 24.5, 24.6, 24.7.1 and 24.7.2 depending on whether you use the console port or Telnet.

Option 5 from **Menu 24 - System Maintenance** allows you to backup the current ZyWALL configuration to your computer. Backup is highly recommended once your ZyWALL is functioning properly. FTP is the preferred method for backing up your current configuration to your computer since it is faster. You can also perform backup and restore using menu 24 through the console port. Any serial communications program should work fine; however, you must use Xmodem protocol to perform the download/upload and you don't have to rename the files.

Please note that terms “download” and “upload” are relative to the computer. Download means to transfer from the ZyWALL to the computer, while upload means from your computer to the ZyWALL.

39.3.1 Backup Configuration

Follow the instructions as shown in the next screen.

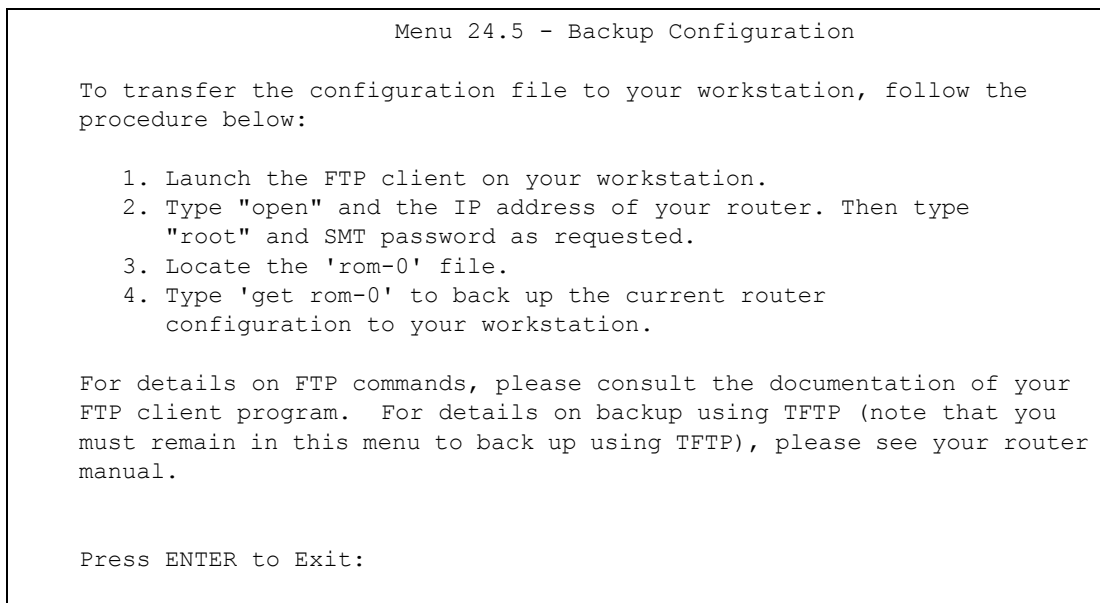
Figure 373 Telnet into Menu 24.5

39.3.2 Using the FTP Command from the Command Line

- 1 Launch the FTP client on your computer.
- 2 Enter “open”, followed by a space and the IP address of your ZyWALL.
- 3 Press [ENTER] when prompted for a username.
- 4 Enter your password as requested (the default is “1234”).
- 5 Enter “bin” to set transfer mode to binary.
- 6 Use “get” to transfer files from the ZyWALL to the computer, for example, “get rom-0 config.rom” transfers the configuration file on the ZyWALL to your computer and renames it “config.rom”. See earlier in this chapter for more information on filename conventions.
- 7 Enter “quit” to exit the ftp prompt.

39.3.3 Example of FTP Commands from the Command Line

Figure 374 FTP Session Example

```

331 Enter PASS command
Password:
230 Logged in
ftp> bin
200 Type I OK
ftp> get rom-0 zyxel.rom
200 Port command okay
150 Opening data connection for STOR ras
226 File received OK
ftp: 16384 bytes sent in 1.10Seconds
297.89Kbytes/sec.
ftp> quit

```

39.3.4 GUI-based FTP Clients

The following table describes some of the commands that you may see in GUI-based FTP clients.

Table 204 General Commands for GUI-based FTP Clients

COMMAND	DESCRIPTION
Host Address	Enter the address of the host server.
Login Type	Anonymous. This is when a user I.D. and password is automatically supplied to the server for anonymous access. Anonymous logins will work only if your ISP or service administrator has enabled this option. Normal. The server requires a unique User ID and Password to login.
Transfer Type	Transfer files in either ASCII (plain text format) or in binary mode. Configuration and firmware files should be transferred in binary mode
Initial Remote Directory	Specify the default remote directory (path).
Initial Local Directory	Specify the default local directory (path).

39.3.5 File Maintenance Over WAN

TFTP, FTP and Telnet over the WAN will not work when:

- 1 The firewall is active (turn the firewall off in menu 21.2 or create a firewall rule to allow access from the WAN).
- 2 You have disabled Telnet service in menu 24.11.
- 3 You have applied a filter in menu 3.1 (LAN) or in menu 11.5 (WAN) to block Telnet service.
- 4 The IP you entered in the **Secured Client IP** field in menu 24.11 does not match the client IP. If it does not match, the ZyWALL will disconnect the Telnet session immediately.
- 5 You have an SMT console session running.

39.3.6 Backup Configuration Using TFTP

The ZyWALL supports the up/downloading of the firmware and the configuration file using TFTP (Trivial File Transfer Protocol) over LAN. Although TFTP should work over WAN as well, it is not recommended.

To use TFTP, your computer must have both telnet and TFTP clients. To backup the configuration file, follow the procedure shown next.

- 1 Use telnet from your computer to connect to the ZyWALL and log in. Because TFTP does not have any security checks, the ZyWALL records the IP address of the telnet client and accepts TFTP requests only from this address.
- 2 Put the SMT in command interpreter (CI) mode by entering 8 in **Menu 24 – System Maintenance**.
- 3 Enter command “sys stdio 0” to disable the SMT timeout, so the TFTP transfer will not be interrupted. Enter command “sys stdio 5” to restore the five-minute SMT timeout (default) when the file transfer is complete.
- 4 Launch the TFTP client on your computer and connect to the ZyWALL. Set the transfer mode to binary before starting data transfer.
- 5 Use the TFTP client (see the example below) to transfer files between the ZyWALL and the computer. The file name for the configuration file is “rom-0” (rom-zero, not capital o).

Note that the telnet connection must be active and the SMT in CI mode before and during the TFTP transfer. For details on TFTP commands (see following example), please consult the documentation of your TFTP client program. For UNIX, use “get” to transfer from the ZyWALL to the computer and “binary” to set binary transfer mode.

39.3.7 TFTP Command Example

The following is an example TFTP command:

```
tftp [-i] host get rom-0 config.rom
```

Where “i” specifies binary image transfer mode (use this mode when transferring binary files), “host” is the ZyWALL IP address, “get” transfers the file source on the ZyWALL (rom-0, name of the configuration file on the ZyWALL) to the file destination on the computer and renames it config.rom.

39.3.8 GUI-based TFTP Clients

The following table describes some of the fields that you may see in GUI-based TFTP clients.

Table 205 General Commands for GUI-based TFTP Clients

COMMAND	DESCRIPTION
Host	Enter the IP address of the ZyWALL. 192.168.1.1 is the ZyWALL’s default IP address when shipped.
Send/Fetch	Use “Send” to upload the file to the ZyWALL and “Fetch” to back up the file on your computer.
Local File	Enter the path and name of the firmware file (*.bin extension) or configuration file (*.rom extension) on your computer.

Table 205 General Commands for GUI-based TFTP Clients

COMMAND	DESCRIPTION
Remote File	This is the filename on the ZyWALL. The filename for the firmware is "ras" and for the configuration file, is "rom-0".
Binary	Transfer the file in binary mode.
Abort	Stop transfer of the file.

Refer to [Section 39.3.5 on page 546](#) to read about configurations that disallow TFTP and FTP over WAN.

39.3.9 Backup Via Console Port

Back up configuration via console port by following the HyperTerminal procedure shown next. Procedures using other serial communications programs should be similar.

- 1 Display menu 24.5 and enter "y" at the following screen.

Figure 375 System Maintenance: Backup Configuration

```
Ready to backup Configuration via Xmodem.
Do you want to continue (y/n):
```

- 2 The following screen indicates that the Xmodem download has started.

Figure 376 System Maintenance: Starting Xmodem Download Screen

```
You can enter ctrl-x to terminate operation any
time.
Starting XMODEM download...
```

- 3 Run the HyperTerminal program by clicking **Transfer**, then **Receive File** as shown in the following screen.

Figure 377 Backup Configuration Example

Type a location for storing the configuration file or click **Browse** to look for one.

Choose the **Xmodem** protocol.

Then click **Receive**.

- 4 After a successful backup you will see the following screen. Press any key to return to the SMT menu.

Figure 378 Successful Backup Confirmation Screen

```
** Backup Configuration completed. OK.
### Hit any key to continue.###
```

39.4 Restore Configuration

This section shows you how to restore a previously saved configuration. Note that this function erases the current configuration before restoring a previous back up configuration; please do not attempt to restore unless you have a backup configuration file stored on disk.

FTP is the preferred method for restoring your current computer configuration to your ZyWALL since FTP is faster. Please note that you must wait for the system to automatically restart after the file transfer is complete.



WARNING!

Do not interrupt the file transfer process as this may PERMANENTLY DAMAGE YOUR ZyWALL. When the Restore Configuration process is complete, the ZyWALL will automatically restart.

39.4.1 Restore Using FTP

For details about backup using (T)FTP please refer to earlier sections on FTP and TFTP file upload in this chapter.

Figure 379 Telnet into Menu 24.6

```
Menu 24.6 -- System Maintenance - Restore Configuration
```

```
To transfer the firmware and configuration file to your workstation,
follow the procedure below:
```

1. Launch the FTP client on your workstation.
2. Type "open" and the IP address of your router. Then type "root" and SMT password as requested.
3. Type "put backupfilename rom-0" where backupfilename is the name of your backup configuration file on your workstation and rom-0 is the remote file name on the router. This restores the configuration to your router.
4. The system reboots automatically after a successful file transfer. For details on FTP commands, please consult the documentation of your FTPclient program.

```
For details on backup using TFTP (note that you must remain in this menu
to back up using TFTP), please see your router manual.
```

```
Press ENTER to Exit:
```

- 1 Launch the FTP client on your computer.
- 2 Enter “open”, followed by a space and the IP address of your ZyWALL.
- 3 Press [ENTER] when prompted for a username.
- 4 Enter your password as requested (the default is “1234”).
- 5 Enter “bin” to set transfer mode to binary.
- 6 Find the “rom” file (on your computer) that you want to restore to your ZyWALL.
- 7 Use “put” to transfer files from the ZyWALL to the computer, for example, “put config.rom rom-0” transfers the configuration file “config.rom” on your computer to the ZyWALL. See earlier in this chapter for more information on filename conventions.
- 8 Enter “quit” to exit the ftp prompt. The ZyWALL will automatically restart after a successful restore process.

39.4.2 Restore Using FTP Session Example

Figure 380 Restore Using FTP Session Example

```
ftp> put config.rom rom-0
200 Port command okay
150 Opening data connection for STOR rom-0
226 File received OK
221 Goodbye for writing flash
ftp: 16384 bytes sent in 0.06Seconds 273.07Kbytes/sec.
ftp>quit
```

Refer to [Section 39.3.5 on page 546](#) to read about configurations that disallow TFTP and FTP over WAN.

39.4.3 Restore Via Console Port

Restore configuration via console port by following the HyperTerminal procedure shown next. Procedures using other serial communications programs should be similar.

- 1 Display menu 24.6 and enter “y” at the following screen.

Figure 381 System Maintenance: Restore Configuration

```
Ready to restore Configuration via Xmodem.
Do you want to continue (y/n):
```

- 2 The following screen indicates that the Xmodem download has started.

Figure 382 System Maintenance: Starting Xmodem Download Screen

```
Starting XMODEM download (CRC mode) ...CCCCCCCC
```

- 3 Run the HyperTerminal program by clicking **Transfer**, then **Send File** as shown in the following screen.

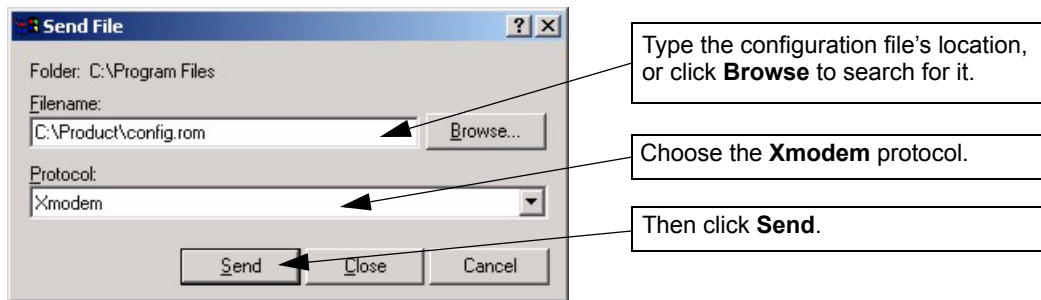
Figure 383 Restore Configuration Example

- 4 After a successful restoration you will see the following screen. Press any key to restart the ZyWALL and return to the SMT menu.

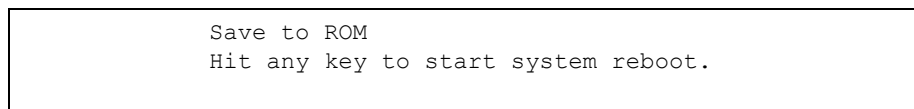
Figure 384 Successful Restoration Confirmation Screen

39.5 Uploading Firmware and Configuration Files

This section shows you how to upload firmware and configuration files. You can upload configuration files by following the procedure in [Section 39.4 on page 549](#) or by following the instructions in **Menu 24.7.2 - System Maintenance - Upload System Configuration File** (for console port).



WARNING!

Do not interrupt the file transfer process as this may PERMANENTLY DAMAGE YOUR ZyWALL.

39.5.1 Firmware File Upload

FTP is the preferred method for uploading the firmware and configuration. To use this feature, your computer must have an FTP client.

When you telnet into the ZyWALL, you will see the following screens for uploading firmware and the configuration file using FTP.

Figure 385 Telnet Into Menu 24.7.1: Upload System Firmware

```
Menu 24.7.1 - System Maintenance - Upload System Firmware

To upload the system firmware, follow the procedure below:

1. Launch the FTP client on your workstation.
2. Type "open" and the IP address of your system. Then type "root" and
SMT password as requested.
3. Type "put firmwarefilename ras" where "firmwarefilename" is the
name of your firmware upgrade file on your workstation and "ras" is the
remote file name on the system.
4. The system reboots automatically after a successful firmware
upload.

For details on FTP commands, please consult the documentation of your
FTP client program. For details on uploading system firmware using TFTP
(note that you must remain on this menu to upload system firmware using
TFTP), please see your manual.

Press ENTER to Exit:
```

39.5.2 Configuration File Upload

You see the following screen when you telnet into menu 24.7.2.

Figure 386 Telnet Into Menu 24.7.2: System Maintenance

```
Menu 24.7.2 - System Maintenance - Upload System Configuration File

To upload the system configuration file, follow the procedure below:

1. Launch the FTP client on your workstation.
2. Type "open" and the IP address of your system. Then type "root" and
SMT password as requested.
3. Type "put configurationfilename rom-0" where
"configurationfilename" is the name of your system configuration file on
your workstation, which will be transferred to the "rom-0" file on the
system.
4. The system reboots automatically after the upload system
configuration file process is complete.

For details on FTP commands, please consult the documentation of your
FTP client program. For details on uploading configuration file using
TFTP (note that you must remain on this menu to upload configuration
file using TFTP), please see your manual.

Press ENTER to Exit:
```

To upload the firmware and the configuration file, follow these examples

39.5.3 FTP File Upload Command from the DOS Prompt Example

- 1 Launch the FTP client on your computer.
- 2 Enter “open”, followed by a space and the IP address of your ZyWALL.
- 3 Press [ENTER] when prompted for a username.
- 4 Enter your password as requested (the default is “1234”).
- 5 Enter “bin” to set transfer mode to binary.
- 6 Use “put” to transfer files from the computer to the ZyWALL, for example, “put firmware.bin ras” transfers the firmware on your computer (firmware.bin) to the ZyWALL and renames it “ras”. Similarly, “put config.rom rom-0” transfers the configuration file on your computer (config.rom) to the ZyWALL and renames it “rom-0”. Likewise “get rom-0 config.rom” transfers the configuration file on the ZyWALL to your computer and renames it “config.rom.” See earlier in this chapter for more information on filename conventions.
- 7 Enter “quit” to exit the ftp prompt.

39.5.4 FTP Session Example of Firmware File Upload

Figure 387 FTP Session Example of Firmware File Upload

```

331 Enter PASS command
Password:
230 Logged in
ftp> bin
200 Type I OK
ftp> put firmware.bin ras
200 Port command okay
150 Opening data connection for STOR ras
226 File received OK
ftp: 1103936 bytes sent in 1.10Seconds
297.89Kbytes/sec.
ftp> quit

```

More commands (found in GUI-based FTP clients) are listed earlier in this chapter.

Refer to [Section 39.3.5 on page 546](#) to read about configurations that disallow TFTP and FTP over WAN.

39.5.5 TFTP File Upload

The ZyWALL also supports the uploading of firmware files using TFTP (Trivial File Transfer Protocol) over LAN. Although TFTP should work over WAN as well, it is not recommended.

To use TFTP, your computer must have both telnet and TFTP clients. To transfer the firmware and the configuration file, follow the procedure shown next.

- 1 Use telnet from your computer to connect to the ZyWALL and log in. Because TFTP does not have any security checks, the ZyWALL records the IP address of the telnet client and accepts TFTP requests only from this address.

- 2 Put the SMT in command interpreter (CI) mode by entering 8 in **Menu 24 – System Maintenance**.
- 3 Enter the command “sys stdio 0” to disable the console timeout, so the TFTP transfer will not be interrupted. Enter “command sys stdio 5” to restore the five-minute console timeout (default) when the file transfer is complete.
- 4 Launch the TFTP client on your computer and connect to the ZyWALL. Set the transfer mode to binary before starting data transfer.
- 5 Use the TFTP client (see the example below) to transfer files between the ZyWALL and the computer. The file name for the firmware is “ras”.

Note that the telnet connection must be active and the ZyWALL in CI mode before and during the TFTP transfer. For details on TFTP commands (see following example), please consult the documentation of your TFTP client program. For UNIX, use “get” to transfer from the ZyWALL to the computer, “put” the other way around, and “binary” to set binary transfer mode.

39.5.6 TFTP Upload Command Example

The following is an example TFTP command:

```
tftp [-i] host put firmware.bin ras
```

Where “i” specifies binary image transfer mode (use this mode when transferring binary files), “host” is the ZyWALL’s IP address, “put” transfers the file source on the computer (firmware.bin – name of the firmware on the computer) to the file destination on the remote host (ras - name of the firmware on the ZyWALL).

Commands that you may see in GUI-based TFTP clients are listed earlier in this chapter.

39.5.7 Uploading Via Console Port

FTP or TFTP are the preferred methods for uploading firmware to your ZyWALL. However, in the event of your network being down, uploading files is only possible with a direct connection to your ZyWALL via the console port. Uploading files via the console port under normal conditions is not recommended since FTP or TFTP is faster. Any serial communications program should work fine; however, you must use the Xmodem protocol to perform the download/upload.

39.5.8 Uploading Firmware File Via Console Port

- 1 Select 1 from **Menu 24.7 – System Maintenance – Upload Firmware** to display **Menu 24.7.1 - System Maintenance - Upload System Firmware**, and then follow the instructions as shown in the following screen.

Figure 388 Menu 24.7.1 As Seen Using the Console Port

```

Menu 24.7.1 - System Maintenance - Upload System Firmware

To upload system firmware:
1. Enter "y" at the prompt below to go into debug mode.
2. Enter "atur" after "Enter Debug Mode" message.
3. Wait for "Starting XMODEM upload" message before activating
Xmodem upload on your terminal.
4. After successful firmware upload, enter "atgo" to restart the router.

Warning: Proceeding with the upload will erase the current system
firmware.

Do You Wish To Proceed: (Y/N)

```

- 2 After the "Starting Xmodem upload" message appears, activate the Xmodem protocol on your computer. Follow the procedure as shown previously for the HyperTerminal program. The procedure for other serial communications programs should be similar.

39.5.9 Example Xmodem Firmware Upload Using HyperTerminal

Click **Transfer**, then **Send File** to display the following screen.

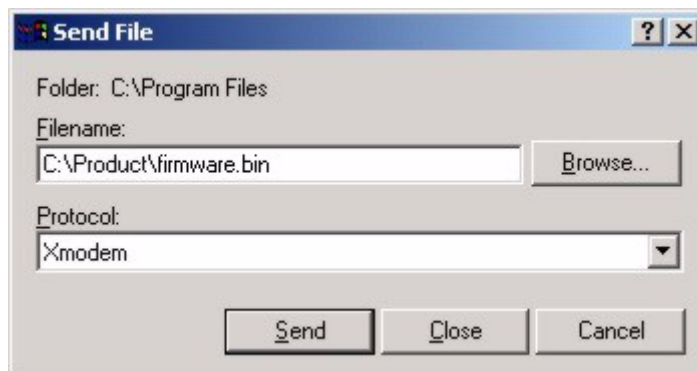
Figure 389 Example Xmodem Upload

After the firmware upload process has completed, the ZyWALL will automatically restart.

39.5.10 Uploading Configuration File Via Console Port

- 1 Select 2 from **Menu 24.7 – System Maintenance – Upload Firmware** to display **Menu 24.7.2 - System Maintenance - Upload System Configuration File**. Follow the instructions as shown in the next screen.

Figure 390 Menu 24.7.2 As Seen Using the Console Port

```

Menu 24.7.2 - System Maintenance - Upload System Configuration File

To upload system configuration file:
1. Enter "y" at the prompt below to go into debug mode.
2. Enter "atlc" after "Enter Debug Mode" message.
3. Wait for "Starting XMODEM upload" message before activating
   Xmodem upload on your terminal.
4. After successful firmware upload, enter "atgo" to restart
   the system.

Warning:
1. Proceeding with the upload will erase the current
   configuration file.
2. The system's console port speed (Menu 24.2.2) may change when it is
   restarted; please adjust your terminal's speed accordingly. The password
   may change (menu 23), also.
3. When uploading the DEFAULT configuration file, the console
   port speed will be reset to 9600 bps and the password to "1234".

Do You Wish To Proceed: (Y/N)

```

- 2 After the "Starting Xmodem upload" message appears, activate the Xmodem protocol on your computer. Follow the procedure as shown previously for the HyperTerminal program. The procedure for other serial communications programs should be similar.
- 3 Enter "atgo" to restart the ZyWALL.

39.5.11 Example Xmodem Configuration Upload Using HyperTerminal

Click **Transfer**, then **Send File** to display the following screen.

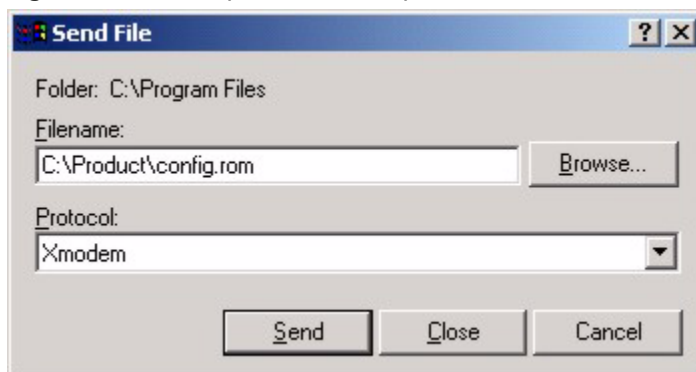
Figure 391 Example Xmodem Upload

After the configuration upload process has completed, restart the ZyWALL by entering "atgo".

System Maintenance Menus 8 to 10

This chapter leads you through SMT menus 24.8 to 24.10.

40.1 Command Interpreter Mode

The Command Interpreter (CI) is a part of the main router firmware. The CI provides much of the same functionality as the SMT, while adding some low-level setup and diagnostic functions. Enter the CI from the SMT by selecting menu 24.8. Access can be by Telnet or by a serial connection to the console port, although some commands are only available with a serial connection. See the included disk or zyxel.com for more detailed information on CI commands. Enter 8 from **Menu 24 - System Maintenance**.



Use of undocumented commands or misconfiguration can damage the unit and possibly render it unusable.

Figure 392 Command Mode in Menu 24

```
Menu 24 - System Maintenance

1. System Status
2. System Information and Console Port Speed
3. Log and Trace
4. Diagnostic
5. Backup Configuration
6. Restore Configuration
7. Upload Firmware
8. Command Interpreter Mode
9. Call Control
10. Time and Date Setting
11. Remote Management Setup

Enter Menu Selection Number:
```

40.1.1 Command Syntax

The command keywords are in `courier` new font.

Enter the command keywords exactly as shown, do not abbreviate.

The required fields in a command are enclosed in angle brackets `<>`.

The optional fields in a command are enclosed in square brackets `[]`.

The `|` symbol means “or”.

For example,

```
sys filter netbios config <type> <on|off>
```

means that you must specify the type of netbios filter and whether to turn it on or off.

40.1.2 Command Usage

A list of commands can be found by typing `help` or `?` at the command prompt. Always type the full command. Type `exit` to return to the SMT main menu when finished.

Figure 393 Valid Commands

```
Copyright (c) 1994 - 2006 ZyXEL Communications Corp.
ras> ?
Valid commands are:
sys          exit          ether          aux
ip           ipsec         bridge        bm
certificates
ras>
```

The following table describes some commands in this screen.

Table 206 Valid Commands

COMMAND	DESCRIPTION
sys	The system commands display device information and configure device settings.
exit	This command returns you to the SMT main menu.
device	The device commands deal with the dial backup connection.
ether	These commands display Ethernet information and configure Ethernet settings.
aux	These commands display dial backup information and control dial backup connections.
ip	These commands display IP information and configure IP settings.
ipsec	These commands display IPSec information and configure IPSec settings.
bridge	These commands display bridge information.
bm	These commands configure bandwidth management settings and display bandwidth management information.
certificates	These commands display certificate information and configure certificate settings.

40.2 Call Control Support

The ZyWALL provides two call control functions: budget management and call history. Please note that this menu is only applicable when **Encapsulation** is set to **PPPoE** or **PPTP** in menu 4 or menu 11.1.

The budget management function allows you to set a limit on the total outgoing call time of the ZyWALL within certain times. When the total outgoing call time exceeds the limit, the current call will be dropped and any future outgoing calls will be blocked.

Call history chronicles preceding incoming and outgoing calls.

To access the call control menu, select option 9 in menu 24 to go to **Menu 24.9 - System Maintenance - Call Control**, as shown in the next table.

Figure 394 Call Control

```

Menu 24.9 - System Maintenance - Call Control

1.Budget Management
2.Call History

Enter Menu Selection Number:

```

40.2.1 Budget Management

Menu 24.9.1 shows the budget management statistics for outgoing calls. Enter 1 from **Menu 24.9 - System Maintenance - Call Control** to bring up the following menu.

Figure 395 Budget Management

```

Menu 24.9.1 - Budget Management

Remote Node      Connection Time/Total Budget      Elapsed Time/Total Period
1.ChangeMe              No Budget                          No Budget
2.Dial                 No Budget                          No Budget

Reset Node (0 to update screen):

```

The total budget is the time limit on the accumulated time for outgoing calls to a remote node. When this limit is reached, the call will be dropped and further outgoing calls to that remote node will be blocked. After each period, the total budget is reset. The default for the total budget is 0 minutes and the period is 0 hours, meaning no budget control. You can reset the accumulated connection time in this menu by entering the index of a remote node. Enter 0 to update the screen. The budget and the reset period can be configured in menu 11.1 for the remote node.

Table 207 Budget Management

FIELD	DESCRIPTION	EXAMPLE
Remote Node	Enter the index number of the remote node you want to reset (just one in this case)	1
Connection Time/ Total Budget	This is the total connection time that has gone by (within the allocated budget that you set in menu 11.1).	5/10 means that 5 minutes out of a total allocation of 10 minutes have lapsed.
Elapsed Time/Total Period	The period is the time cycle in hours that the allocation budget is reset (see menu 11.1.) The elapsed time is the time used up within this period.	0.5/1 means that 30 minutes out of the 1-hour time period has lapsed.
Enter "0" to update the screen or press [ESC] to return to the previous screen.		

40.2.2 Call History

This is the second option in **Menu 24.9 - System Maintenance - Call Control**. It displays information about past incoming and outgoing calls. Enter 2 from **Menu 24.9 - System Maintenance - Call Control** to bring up the following menu.

Figure 396 Call History

Menu 24.9.2 - Call History							
	Phone Number	Dir	Rate	#call	Max	Min	Total
1.							
2.							
3.							
4.							
5.							
6.							
7.							
8.							
9.							
10.							
Enter Entry to Delete(0 to exit):							

The following table describes the fields in this screen.

Table 208 Call History

FIELD	DESCRIPTION
Phone Number	The PPPoE service names are shown here.
Dir	This shows whether the call was incoming or outgoing.

Table 208 Call History

FIELD	DESCRIPTION
Rate	This is the transfer rate of the call.
#call	This is the number of calls made to or received from that telephone number.
Max	This is the length of time of the longest telephone call.
Min	This is the length of time of the shortest telephone call.
Total	This is the total length of time of all the telephone calls to/from that telephone number.
You may enter an entry number to delete it or "0" to exit.	

40.3 Time and Date Setting

The ZyWALL's Real Time Chip (RTC) keeps track of the time and date. There is also a software mechanism to set the time manually or get the current time and date from an external server when you turn on your ZyWALL. Menu 24.10 allows you to update the time and date settings of your ZyWALL. The real time is then displayed in the ZyWALL error logs and firewall logs.

Select menu 24 in the main menu to open **Menu 24 - System Maintenance**, as shown next.

Figure 397 Menu 24: System Maintenance

Menu 24 - System Maintenance
<ol style="list-style-type: none"> 1. System Status 2. System Information and Console Port Speed 3. Log and Trace 4. Diagnostic 5. Backup Configuration 6. Restore Configuration 7. Upload Firmware 8. Command Interpreter Mode 9. Call Control 10. Time and Date Setting 11. Remote Management Setup
Enter Menu Selection Number:

Enter 10 to go to **Menu 24.10 - System Maintenance - Time and Date Setting** to update the time and date settings of your ZyWALL as shown in the following screen.

Figure 398 Menu 24.10 System Maintenance: Time and Date Setting

```

Menu 24.10 - System Maintenance - Time and Date Setting

Time Protocol= NTP (RFC-1305)
Time Server Address= a.ntp.alphazed.net

Current Time:                08 : 24 : 26
New Time (hh:mm:ss):        N/A  N/A  N/A

Current Date:                2006 - 09 - 04
New Date (yyyy-mm-dd):      N/A   N/A  N/A

Time Zone= GMT

Daylight Saving= No
Start Date (mm-nth-week-hr): Jan. - 1st - Sun. - 00
End Date (mm-nth-week-hr):   Jan. - 1st - Sun. - 00

Press ENTER to Confirm or ESC to Cancel:

```

The following table describes the fields in this screen.

Table 209 Menu 24.10 System Maintenance: Time and Date Setting

FIELD	DESCRIPTION
Time Protocol	Enter the time service protocol that your timeserver uses. Not all time servers support all protocols, so you may have to check with your ISP/network administrator or use trial and error to find a protocol that works. The main differences between them are the format. Daytime (RFC 867) format is day/month/year/time zone of the server. Time (RFC-868) format displays a 4-byte integer giving the total number of seconds since 1970/1/1 at 0:0:0. The default, NTP (RFC-1305) , is similar to Time (RFC-868) . Select Manual to enter the new time and new date manually.
Time Server Address	Enter the IP address or domain name of your timeserver. Check with your ISP/network administrator if you are unsure of this information.
Current Time	This field displays an updated time only when you reenter this menu.
New Time	Enter the new time in hour, minute and second format. This field is available when you select Manual in the Time Protocol field.
Current Date	This field displays an updated date only when you reenter this menu.
New Date	Enter the new date in year, month and day format. This field is available when you select Manual in the Time Protocol field.
Time Zone	Press [SPACE BAR] and then [ENTER] to set the time difference between your time zone and Greenwich Mean Time (GMT).
Daylight Saving	Daylight Saving Time is a period from late spring to early fall when many countries set their clocks ahead of normal local time by one hour to give more daylight time in the evenings. If you use daylight savings time, then choose Yes .

Table 209 Menu 24.10 System Maintenance: Time and Date Setting

FIELD	DESCRIPTION
Start Date (mm-nth-week-hr)	<p>Configure the day and time when Daylight Saving Time starts if you selected Yes in the Daylight Saving field. The hr field uses the 24 hour format. Here are a couple of examples:</p> <p>Daylight Saving Time starts in most parts of the United States on the first Sunday of April. Each time zone in the United States starts using Daylight Saving Time at 2 A.M. local time. So in the United States you would select Apr., 1st, Sun. and type 02 in the hr field.</p> <p>Daylight Saving Time starts in the European Union on the last Sunday of March. All of the time zones in the European Union start using Daylight Saving Time at the same moment (1 A.M. GMT or UTC). So in the European Union you would select Mar., Last, Sun. The time you type in the hr field depends on your time zone. In Germany for instance, you would type 02 because Germany's time zone is one hour ahead of GMT or UTC (GMT+1).</p>
End Date (mm-nth-week-hr)	<p>Configure the day and time when Daylight Saving Time ends if you selected Yes in the Daylight Saving field. The hr field uses the 24 hour format. Here are a couple of examples:</p> <p>Daylight Saving Time ends in the United States on the last Sunday of October. Each time zone in the United States stops using Daylight Saving Time at 2 A.M. local time. So in the United States you would select Oct., Last, Sun. and type 02 in the hr field.</p> <p>Daylight Saving Time ends in the European Union on the last Sunday of October. All of the time zones in the European Union stop using Daylight Saving Time at the same moment (1 A.M. GMT or UTC). So in the European Union you would select Oct., Last, Sun. The time you type in the hr field depends on your time zone. In Germany for instance, you would type 02 because Germany's time zone is one hour ahead of GMT or UTC (GMT+1).</p>
<p>Once you have filled in this menu, press [ENTER] at the message "Press ENTER to Confirm or ESC to Cancel" to save your configuration, or press [ESC] to cancel.</p>	

Remote Management

This chapter covers remote management found in SMT menu 24.11.

41.1 Remote Management

Remote management allows you to determine which services/protocols can access which ZyWALL interface (if any) from which computers.



When you configure remote management to allow management from any network except the LAN, you still need to configure a firewall rule to allow access. See [Chapter 11 on page 181](#) for details on configuring firewall rules.

You can also disable a service on the ZyWALL by not allowing access for the service/protocol through any of the ZyWALL interfaces.

To disable remote management of a service, select **Disable** in the corresponding **Access** field. Enter 11 from menu 24 to bring up **Menu 24.11 - Remote Management Control**.

Figure 399 Menu 24.11 – Remote Management Control

```

Menu 24.11 - Remote Management Control

TELNET Server:      Port = 23          Access = LAN
                   Secure Client IP = 0.0.0.0

FTP Server:        Port = 21          Access = LAN+WAN+DMZ+WLAN
                   Secure Client IP = 0.0.0.0

SSH Server:        Certificate = auto_generated_self_signed_cert
                   Port = 22          Access = LAN+WAN+DMZ+WLAN
                   Secure Client IP = 0.0.0.0

HTTPS Server:      Certificate = auto_generated_self_signed_cert
                   Authenticate Client Certificates = No
                   Port = 443         Access = LAN+WAN+DMZ+WLAN
                   Secure Client IP = 0.0.0.0

HTTP Server:       Port = 80          Access = LAN+WAN+DMZ+WLAN
                   Secure Client IP = 0.0.0.0

SNMP Service:     Port = 161         Access = LAN+WAN+DMZ+WLAN
                   Secure Client IP = 0.0.0.0

DNS Service:      Port = 53          Access = LAN+WAN+DMZ+WLAN
                   Secure Client IP = 0.0.0.0

Press ENTER to Confirm or ESC to Cancel:

```

The following table describes the fields in this screen.

Table 210 Menu 24.11 – Remote Management Control

FIELD	DESCRIPTION
Telnet Server FTP Server SSH Server HTTPS Server HTTP Server SNMP Service DNS Service	Each of these read-only labels denotes a service that you may use to remotely manage the ZyWALL.
Port	This field shows the port number for the service or protocol. You may change the port number if needed, but you must use the same port number to access the ZyWALL.
Access	Select the access interface (if any) by pressing [SPACE BAR], then [ENTER] to choose from: LAN, WAN, LAN+WAN, DMZ, LAN+DMZ, WAN+DMZ, LAN+WAN+DMZ, WLAN, LAN+WLAN, WAN+WLAN, LAN+WAN+WLAN, DMZ+WLAN, LAN+DMZ+WLAN, WAN+DMZ+WLAN, LAN+WAN+DMZ+WLAN or Disable .
Secure Client IP	The default 0.0.0.0 allows any client to use this service to remotely manage the ZyWALL. Enter an IP address to restrict access to a client with a matching IP address.
Certificate	Press [SPACE BAR] and then [ENTER] to select the certificate that the ZyWALL will use to identify itself. The ZyWALL is the SSL server and must always authenticate itself to the SSL client (the computer which requests the HTTPS connection with the ZyWALL).

Table 210 Menu 24.11 – Remote Management Control (continued)

FIELD	DESCRIPTION
Authenticate Client Certificates	Select Yes by pressing [SPACE BAR], then [ENTER] to require the SSL client to authenticate itself to the ZyWALL by sending the ZyWALL a certificate. To do that the SSL client must have a CA-signed certificate from a CA that has been imported as a trusted CA on the ZyWALL (see Appendix F on page 619 for details).
Once you have filled in this menu, press [ENTER] at the message "Press ENTER to Confirm or ESC to Cancel" to save your configuration, or press [ESC] to cancel.	

41.1.1 Remote Management Limitations

Remote management over LAN or WAN will not work when:

- 1 A filter in menu 3.1 (LAN) or in menu 11.5 (WAN) is applied to block a Telnet, FTP or Web service.
- 2 You have disabled that service in menu 24.11.
- 3 The IP address in the **Secure Client IP** field (menu 24.11) does not match the client IP address. If it does not match, the ZyWALL will disconnect the session immediately.
- 4 There is an SMT console session running.
- 5 There is already another remote management session with an equal or higher priority running. You may only have one remote management session running at one time.
- 6 There is a firewall rule that blocks it.

Call Scheduling

Call scheduling allows you to dictate when a remote node should be called and for how long.

42.1 Introduction to Call Scheduling

The call scheduling feature allows the ZyWALL to manage a remote node and dictate when a remote node should be called and for how long. This feature is similar to the scheduler in a videocassette recorder (you can specify a time period for the VCR to record). You can apply up to 4 schedule sets in **Menu 11.1 - Remote Node Profile**. From the main menu, enter 26 to access **Menu 26 - Schedule Setup** as shown next.

Figure 400 Schedule Setup

Menu 26 - Schedule Setup			
Schedule Set #	Name	Schedule Set #	Name
1	_____	7	_____
2	_____	8	_____
3	_____	9	_____
4	_____	10	_____
5	_____	11	_____
6	_____	12	_____

Enter Schedule Set Number to Configure= 0
 Edit Name= N/A
 Press ENTER to Confirm or ESC to Cancel:

Lower numbered sets take precedence over higher numbered sets thereby avoiding scheduling conflicts. For example, if sets 1, 2, 3 and 4 are applied in the remote node, then set 1 will take precedence over set 2, 3 and 4 as the ZyWALL, by default, applies the lowest numbered set first. Set 2 will take precedence over set 3 and 4, and so on.

You can design up to 12 schedule sets but you can only apply up to four schedule sets for a remote node.



To delete a schedule set, enter the set number and press [SPACE BAR] and then [ENTER] or [DEL] in the Edit Name field.

To set up a schedule set, select the schedule set you want to setup from menu 26 (1-12) and press [ENTER] to see **Menu 26.1 - Schedule Set Setup** as shown next.

Figure 401 Schedule Set Setup

```

Menu 26.1 - Schedule Set Setup

Active= Yes
How Often= Once
Start Date (yyyy-mm-dd) = N/A
Once:
  Date (yyyy-mm-dd) = 2000 - 01 - 01
Weekdays:
  Sunday= N/A
  Monday= N/A
  Tuesday= N/A
  Wednesday= N/A
  Thursday= N/A
  Friday= N/A
  Saturday= N/A
Start Time (hh:mm)= 00 : 00
Duration (hh:mm)= 00 : 00
Action= Forced On

Press ENTER to Confirm or ESC to Cancel:
Press Space Bar to Toggle

```

If a connection has been already established, your ZyWALL will not drop it. Once the connection is dropped manually or it times out, then that remote node can't be triggered up until the end of the **Duration**.

Table 211 Schedule Set Setup

FIELD	DESCRIPTION
Active	Press [SPACE BAR] to select Yes or No . Choose Yes and press [ENTER] to activate the schedule set.
How Often	Should this schedule set recur weekly or be used just once only? Press [SPACE BAR] and then [ENTER] to select Once or Weekly . Both these options are mutually exclusive. If Once is selected, then all weekday settings are N/A . When Once is selected, the schedule rule deletes automatically after the scheduled time elapses.
Start Date	Enter the start date when you wish the set to take effect in year -month-date format. Valid dates are from the present to 2036-February-5.
Once:	
Date	If you selected Once in the How Often field above, then enter the date the set should activate here in year-month-date format.
Weekdays:	

Table 211 Schedule Set Setup (continued)

FIELD	DESCRIPTION
Day	If you selected Weekly in the How Often field above, then select the day(s) when the set should activate (and recur) by going to that day(s) and pressing [SPACE BAR] to select Yes , then press [ENTER].
Start Time	Enter the start time when you wish the schedule set to take effect in hour-minute format.
Duration	The duration determines how long the ZyWALL is to apply the action configured in the Action field. Enter the maximum length of time in hour-minute format.
Action	<p>Forced On means that the connection is maintained whether or not there is a demand call on the line and will persist for the time period specified in the Duration field.</p> <p>Forced Down means that the connection is blocked whether or not there is a demand call on the line.</p> <p>Enable Dial-On-Demand means that this schedule permits a demand call on the line.</p> <p>Disable Dial-On-Demand means that this schedule prevents a demand call on the line.</p>
When you have completed this menu, press [ENTER] at the prompt "Press ENTER to Confirm..." to save your configuration, or press [ESC] at any time to cancel.	

Once your schedule sets are configured, you must then apply them to the desired remote node(s). Enter 11 from the Main Menu and then enter the target remote node index. Press [SPACE BAR] and then [ENTER] to select **PPPoE** in the **Encapsulation** field to make the schedule sets field available as shown next.

Figure 402 Applying Schedule Set(s) to a Remote Node (PPPoE)

```

Menu 11.1 - Remote Node Profile

Rem Node Name= ChangeMe      Route= IP
Active= Yes

Encapsulation= PPPoE        Edit IP= No
Service Type= Standard      Telco Option:
Service Name=                Allocated Budget (min)= 0
Outgoing=                    Period (hr)= 0
My Login=                    Schedules= 1,2,3,4
My Password= *****        Nailed-Up Connection= No
Authen= CHAP/PAP

Session Options:
Edit Filter Sets= No
Idle Timeout(sec)= 100

Edit Traffic Redirect= No

Press ENTER to Confirm or ESC to Cancel:

```

You can apply up to four schedule sets, separated by commas, for one remote node. Change the schedule set numbers to your preference(s).

Figure 403 Applying Schedule Set(s) to a Remote Node (PPTP)

```
Menu 11.1 - Remote Node Profile

Rem Node Name= ChangeMe           Route= IP
Active= Yes

Encapsulation= PPTP               Edit IP= No
Service Type= Standard           Telco Option:
                                   Allocated Budget(min)= 0
                                   Period(hr)= 0
                                   Schedules= 1,2,3,4
                                   Nailed-up Connections= No

Outgoing=
  My Login=
  My Password= *****
  Retype to Confirm= *****
  Authen= CHAP/PAP
PPTP:
  My IP Addr=
  My IP Mask=
  Server IP Addr=
  Connection ID/Name=

                                   Session Options:
                                   Edit Filter Sets= No
                                   Idle Timeout(sec)= 100

                                   Edit Traffic Redirect= No

Press ENTER to Confirm or ESC to Cancel:
```

Troubleshooting

This chapter offers some suggestions to solve problems you might encounter. The potential problems are divided into the following categories.

- [Power, Hardware Connections, and LEDs](#)
- [ZyWALL Access and Login](#)
- [Internet Access](#)

43.1 Power, Hardware Connections, and LEDs



The ZyWALL does not turn on. None of the LEDs turn on when you turn on the ZyWALL.

- 7** Make sure you are using the power adaptor or cord included with the ZyWALL.
- 8** Make sure the power adaptor or cord is connected to the ZyWALL and plugged in to an appropriate power source. Make sure the power source is turned on.
- 9** Disconnect and re-connect the power adaptor or cord to the ZyWALL.
- 10** If the problem continues, contact the vendor.



One of the LEDs does not behave as expected.

- 1** Make sure you understand the normal behavior of the LED. See [Section 1.5 on page 47](#).
- 2** Check the hardware connections. See the Quick Start Guide.
- 3** Inspect your cables for damage. Contact the vendor to replace any damaged cables.
- 4** Disconnect and re-connect the power adaptor to the ZyWALL.
- 5** If the problem continues, contact the vendor.

43.2 ZyWALL Access and Login



I forgot the IP address for the ZyWALL.

- 1 The default IP address is **192.168.1.1**.
- 2 Use the console port to log in to the ZyWALL.
- 3 If you changed the IP address and have forgotten it, you might get the IP address of the ZyWALL by looking up the IP address of the default gateway for your computer. To do this in most Windows computers, click **Start > Run**, enter **cmd**, and then enter **ipconfig**. The IP address of the **Default Gateway** might be the IP address of the ZyWALL (it depends on the network), so enter this IP address in your Internet browser.
- 4 If this does not work, you have to reset the device to its factory defaults. See [Section 2.3 on page 51](#).



I forgot the password.

- 1 The default password is **1234**.
- 2 If this does not work, you have to reset the device to its factory defaults. See [Section 2.3 on page 51](#).



I cannot see or access the Login screen in the web configurator.

- 1 Make sure you are using the correct IP address.
 - The default LAN IP address is **192.168.1.1**. If you changed the LAN IP address ([Section 6.7 on page 126](#)), enter the new one as the URL.
 - If you changed the LAN IP address and have forgotten it, see the troubleshooting suggestions for [I forgot the IP address for the ZyWALL](#).
 - Use the ZyWALL's WAN IP address when configuring from the WAN.
- 2 Check the hardware connections, and make sure the LEDs are behaving as expected. See the Quick Start Guide .
- 3 Make sure your Internet browser does not block pop-up windows and has JavaScripts and Java enabled. See [Appendix C on page 601](#).
- 4 Make sure your computer is in the same subnet as the ZyWALL for LAN access. (If you know that there are routers between your computer and the ZyWALL, skip this step.)
 - If there is a DHCP server on your network, make sure your computer is using a dynamic IP address. See [Section 43.1 on page 573](#). Your ZyWALL is a DHCP server by default.
- 5 Reset the device to its factory defaults, and try to access the ZyWALL with the default IP address. See [Section 2.3 on page 51](#).

- 6 If the problem continues, contact the network administrator or vendor, or try one of the advanced suggestions.

Advanced Suggestions

- You may also need to clear your Internet browser's cache.
In Internet Explorer, click **Tools** and then **Internet Options** to open the **Internet Options** screen.
In the **General** tab, click **Delete Files**. In the pop-up window, select the **Delete all offline content** check box and click **OK**. Click **OK** in the **Internet Options** screen to close it.
- If you disconnect your computer from one device and connect it to another device that has the same IP address, your computer's ARP (Address Resolution Protocol) table may contain an entry that maps the management IP address to the previous device's MAC address).
In Windows, use **arp -d** at the command prompt to delete all entries in your computer's ARP table.
- Try to access the ZyWALL using another service, such as Telnet. If you can access the ZyWALL, check the remote management settings, firewall rules, and SMT filters to find out why the ZyWALL does not respond to HTTP.
- If your computer is connected to the **WAN** port or is connected wirelessly, use a computer that is connected to a **LAN** port.



I can see the Login screen, but I cannot log in to the ZyWALL.

- 1 Make sure you have entered the user name and password correctly. The default user name is **admin**, and the default password is **1234**. These fields are case-sensitive, so make sure [Caps Lock] is not on.
- 2 You cannot log in to the web configurator while someone is using the SMT, Telnet, or the console port to access the ZyWALL. Log out of the ZyWALL in the other session, or ask the person who is logged in to log out.
- 3 Disconnect and re-connect the power adaptor or cord to the ZyWALL.
- 4 If this does not work, you have to reset the device to its factory defaults. See [Section 2.3 on page 51](#).



I cannot access the SMT. / I cannot Telnet to the ZyWALL.

See the troubleshooting suggestions for [I cannot see or access the Login screen in the web configurator](#). Ignore the suggestions about your browser.



I cannot use FTP to upload / download the configuration file. / I cannot use FTP to upload new firmware.

See the troubleshooting suggestions for [I cannot see or access the Login screen in the web configurator](#). Ignore the suggestions about your browser.



I cannot use the console port to access the ZyWALL.

- 1 Check to see if the ZyWALL is connected to your computer's console port.
- 2 Check to see if the communications program is configured correctly. The communications software should be configured as follows:
 - VT100 terminal emulation.
 - 9600 bps is the default speed on leaving the factory. Try other speeds in case the speed has been changed.
 - No parity, 8 data bits, 1 stop bit, data flow set to none.



I cannot ping any computer on the LAN.

- 1 Check the 10M/100M LAN LEDs on the front panel. One of these LEDs should be on. If they are both off, check the cables between your ZyWALL and hub or the station.
- 2 Verify that the IP address and the subnet mask of the ZyWALL and the computers are on the same subnet.



I cannot access servers on the DMZ from the LAN.

- 1 Check your Ethernet cable type and connections. Refer to the Quick Start Guide for DMZ connection instructions.
- 2 Make sure the Ethernet adapters on the LAN computer and the DMZ server are installed and functioning properly.
- 3 Verify that the IP address of the DMZ port and the LAN port are on separate subnets.
- 4 Make sure that NAT is configured for your DMZ servers.

43.3 Internet Access



I cannot access the Internet.

- 1 Check the hardware connections, and make sure the LEDs are behaving as expected. See the Quick Start Guide and [Section 43.1 on page 573](#).

- 2 Make sure you entered your ISP account information correctly in the wizard. These fields are case-sensitive, so make sure [Caps Lock] is not on.
- 3 Disconnect all the cables from your device, and follow the directions in the Quick Start Guide again.
- 4 If the problem continues, contact your ISP.



I cannot get a WAN IP address from the ISP.

The ISP provides the WAN IP address after authentication. Authentication may be through the user name and password, the MAC address or the host name. Use the following corrective actions to make sure the ISP can authenticate your connection.

- 1 You need a user name and password if you're using PPPoE or PPTP encapsulation. Make sure that you have entered the correct **Service Type**, **User Name** and **Password** (the user name and password are case sensitive). Refer to [Section 8.7 on page 144](#) or [Section 30.1 on page 473](#).
- 2 If your ISP requires MAC address authentication, you should clone the MAC address from your computer on the LAN as the ZyWALL's WAN MAC address. Refer to [Section 8.7 on page 144](#) or [Section 28.2 on page 455](#). It is recommended that you clone your computer's MAC address, even if your ISP presently does not require MAC address authentication.
- 3 If your ISP requires host name authentication, configure your computer's name as the ZyWALL's system name. Refer to [Section 25.2 on page 423](#) or [Section 27.2 on page 449](#).



I cannot access the Internet anymore. I had access to the Internet (with the ZyWALL), but my Internet connection is not available anymore.

- 1 Check the hardware connections, and make sure the LEDs are behaving as expected. See the Quick Start Guide and [Section 43.1 on page 573](#).
- 2 Reboot the ZyWALL.
- 3 If the problem continues, contact your ISP.



The Internet connection is slow or intermittent.

- 1 There might be a lot of traffic on the network. Look at the LEDs, and check [Section 1.5 on page 47](#). If the ZyWALL is sending or receiving a lot of information, try closing some programs that use the Internet, especially peer-to-peer applications.
- 2 Reboot the ZyWALL.
- 3 If the problem continues, contact the network administrator or vendor, or try one of the advanced suggestions.

Advanced Suggestions

- Check the settings for bandwidth management. If it is disabled, you might consider activating it. If it is enabled, you might consider changing the allocations.

PART VII

Appendices and Index

Product Specifications (581)
Setting up Your Computer's IP Address (585)
Pop-up Windows, JavaScripts and Java Permissions (601)
IP Addresses and Subnetting (607)
Common Services (615)
Importing Certificates (619)
Command Interpreter (631)
Firewall Commands (639)
NetBIOS Filter Commands (645)
Certificates Commands (647)
Brute-Force Password Guessing Protection (651)
Boot Commands (653)
Legal Information (655)
Customer Support (659)
Index (663)

Product Specifications

The following tables summarize the ZyWALL's hardware and firmware features.

Table 212 Hardware Specifications

Dimensions (W x D x H)	181(W) x 128(D) x 36(H) mm
Weight	304g
Power Specification	12 V DC 1 A
Ethernet Ports	Auto-negotiating: 10 Mbps or 100 Mbps in either half-duplex or full-duplex mode. Auto-crossover: Use either crossover or straight-through Ethernet cables.
Reset Button	Restores factory default settings
Console	RJ-45 port for RS-232 null modem connection
Dial Backup	RJ-45 port for RS-232 connection
Operation Temperature	0° C ~ 50° C
Storage Temperature	-30° C ~ 60° C
Operation Humidity	20% ~ 95% RH (non-condensing)
Storage Humidity	20% ~ 95% RH (non-condensing)
Certifications	EMC: FCC Class B, CE-EMC Class B, C-Tick Class B, VCCI Class B Safety: CSA International, CE EN60950-1

Table 213 Firmware Specifications

FEATURE	DESCRIPTION
Default IP Address	192.168.1.1
Default Subnet Mask	255.255.255.0 (24 bits)
Default Password	1234
DHCP Pool	192.168.1.33 to 192.168.1.160
Device Management	Use the web configurator to easily configure the rich range of features on the ZyWALL.
Firmware Upgrade	Download new firmware (when available) from the ZyXEL web site and use the web configurator, an FTP or a TFTP tool to put it on the ZyWALL. Note: Only upload firmware for your specific model!
Configuration Backup & Restoration	Make a copy of the ZyWALL's configuration. You can put it back on the ZyWALL later if you decide to revert back to an earlier configuration.

Table 213 Firmware Specifications

FEATURE	DESCRIPTION
Network Address Translation (NAT)	Each computer on your network must have its own unique IP address. Use NAT to convert your public IP address(es) to multiple private IP addresses for the computers on your network.
Port Forwarding	If you have a server (mail or web server for example) on your network, you can use this feature to let people access it from the Internet.
DHCP (Dynamic Host Configuration Protocol)	Use this feature to have the ZyWALL assign IP addresses, an IP default gateway and DNS servers to computers on your network.
Dynamic DNS Support	With Dynamic DNS (Domain Name System) support, you can use a fixed URL, www.zyxel.com for example, with a dynamic IP address. You must register for this service with a Dynamic DNS service provider.
IP Multicast	IP multicast is used to send traffic to a specific group of computers. The ZyWALL supports versions 1 and 2 of IGMP (Internet Group Management Protocol) used to join multicast groups (see RFC 2236).
IP Alias	IP alias allows you to subdivide a physical network into logical networks over the same Ethernet interface with the ZyWALL itself as the gateway for each subnet.
Time and Date	Get the current time and date from an external server when you turn on your ZyWALL. You can also set the time manually. These dates and times are then used in logs.
Logging and Tracing	Use packet tracing and logs for troubleshooting. You can send logs from the ZyWALL to an external syslog server.
PPPoE	PPPoE mimics a dial-up Internet access connection.
PPTP Encapsulation	Point-to-Point Tunneling Protocol (PPTP) enables secure transfer of data through a Virtual Private Network (VPN). The ZyWALL supports one PPTP connection at a time.
Universal Plug and Play (UPnP)	A UPnP-enabled device can dynamically join a network, obtain an IP address and convey its capabilities to other devices on the network.
RoadRunner Support	The ZyWALL supports Time Warner's RoadRunner Service in addition to standard cable modem services.
Firewall	You can configure firewall on the ZyXEL Device for secure Internet access. When the firewall is on, by default, all incoming traffic from the Internet to your network is blocked unless it is initiated from your network. This means that probes from the outside to your network are not allowed, but you can safely browse the Internet and download files for example.
Content Filter	The ZyWALL blocks or allows access to web sites that you specify and blocks access to web sites with URLs that contain keywords that you specify. You can define time periods and days during which content filtering is enabled. You can also include or exclude particular computers on your network from content filtering. You can also subscribe to category-based content filtering that allows your ZyWALL to check web sites against an external database.
Bandwidth Management	You can efficiently manage traffic on your network by reserving bandwidth and giving priority to certain types of traffic and/or to particular computers.
Remote Managemet	This allows you to decide whether a service (HTTP or FTP traffic for example) from a computer on a network (LAN or WAN for example) can access the ZyWALL.

Table 214 Feature Specifications

FEATURE	SPECIFICATION
Number of Local User Database Entries	32
Number of Static DHCP Table Entries	32
Number of Static Routes	12
Number of Port Forwarding Rules	20
Number of NAT Sessions	3000
Number of Address Mapping Rules	10
Number of IPSec VPN Tunnels/Security Associations	2
Number of Bandwidth Management Classes	10
Number of Bandwidth Management Class Levels	1
Number of DNS Address Record Entries	30
Number of DNS Name Server Record Entries	16

Table 215 Performance

CATEGORY	PERFORMANCE
Firewall Throughput	24Mbps
VPN 3DES/AES Throughput	24Mbps
User Licenses	Unlimited
Concurrent Sessions	3000
Simultaneous IPSec VPN Connections	5

Cable Pin Assignments

In a serial communications connection, generally a computer is DTE (Data Terminal Equipment) and a modem is DCE (Data Circuit-terminating Equipment). The ZyWALL is DCE when you connect a computer to the console port. The ZyWALL is DTE when you connect a modem to the dial backup port.¹

The console cable and dial backup cable each have an RJ-45 connector and a DB-9 connector. The pin layout for the DB-9 connector end of the cables is as follows.

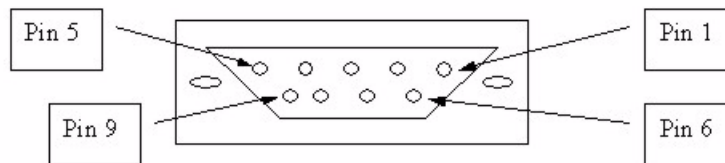
Figure 404 Console/Dial Backup Cable DB-9 End Pin Layout

1. Pins 2,3 and 5 are used.









Table 216 Console Cable Pin Assignments

PIN DEFINITION	RJ-45 END	DB-9M (MALE) END
DSR	1	6
DTR	2	4
TX	3	3
RTS	4	7
GND	5	5
RX	6	2
CTS	7	8
DCD	8	1
	N/A	9

Table 217 Console Cable Pin Assignments

PIN DEFINITION	RJ-45 END	DB-9M (MALE) END
DTR	1	4
DSR	2	6
RX	3	2
CTS	4	8
GND	5	5
TX	6	3
RTS	7	7
DCD	8	1
	N/A	9

Table 218 Ethernet Cable Pin Assignments

WAN / LAN ETHERNET CABLE PIN LAYOUT					
Straight-through			Crossover		
(Switch)		(Adapter)	(Switch)		(Switch)
1 IRD +		1 OTD +	1 IRD +		1 IRD +
2 IRD -		2 OTD -	2 IRD -		2 IRD -
3 OTD +		3 IRD +	3 OTD +		3 OTD +
6 OTD -		6 IRD -	6 OTD -		6 OTD -

Setting up Your Computer's IP Address

All computers must have a 10M or 100M Ethernet adapter card and TCP/IP installed.

Windows 95/98/Me/NT/2000/XP, Macintosh OS 7 and later operating systems and all versions of UNIX/LINUX include the software components you need to install and use TCP/IP on your computer. Windows 3.1 requires the purchase of a third-party TCP/IP application package.

TCP/IP should already be installed on computers using Windows NT/2000/XP, Macintosh OS 7 and later operating systems.

After the appropriate TCP/IP components are installed, configure the TCP/IP settings in order to "communicate" with your network.

If you manually assign IP information instead of using dynamic assignment, make sure that your computers have IP addresses that place them in the same subnet as the ZyWALL's LAN port.

Windows 95/98/Me

Click **Start**, **Settings**, **Control Panel** and double-click the **Network** icon to open the **Network** window.

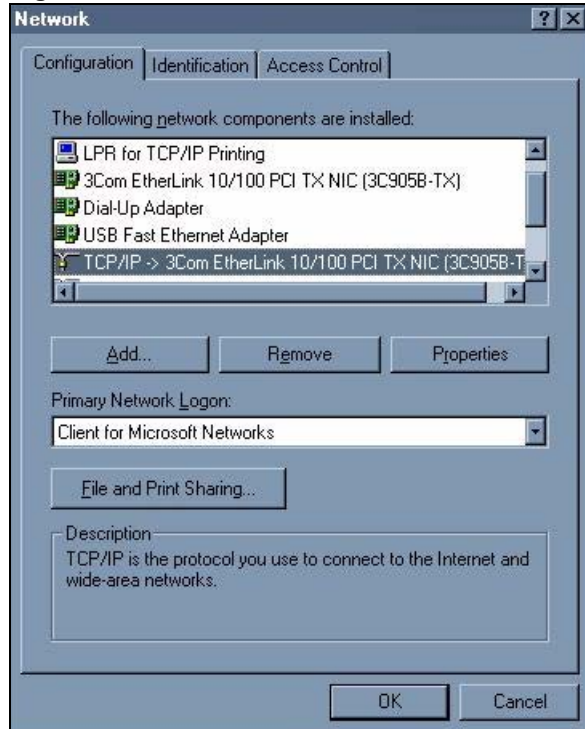
Figure 405 Windows 95/98/Me: Network: Configuration

Installing Components

The **Network** window **Configuration** tab displays a list of installed components. You need a network adapter, the TCP/IP protocol and Client for Microsoft Networks.

If you need the adapter:

- 1 In the **Network** window, click **Add**.
- 2 Select **Adapter** and then click **Add**.
- 3 Select the manufacturer and model of your network adapter and then click **OK**.

If you need TCP/IP:

- 1 In the **Network** window, click **Add**.
- 2 Select **Protocol** and then click **Add**.
- 3 Select **Microsoft** from the list of **manufacturers**.
- 4 Select **TCP/IP** from the list of network protocols and then click **OK**.

If you need Client for Microsoft Networks:

- 1 Click **Add**.
- 2 Select **Client** and then click **Add**.
- 3 Select **Microsoft** from the list of manufacturers.
- 4 Select **Client for Microsoft Networks** from the list of network clients and then click **OK**.
- 5 Restart your computer so the changes you made take effect.

Configuring

- 1 In the **Network** window **Configuration** tab, select your network adapter's TCP/IP entry and click **Properties**
- 2 Click the **IP Address** tab.
 - If your IP address is dynamic, select **Obtain an IP address automatically**.
 - If you have a static IP address, select **Specify an IP address** and type your information into the **IP Address** and **Subnet Mask** fields.

Figure 406 Windows 95/98/Me: TCP/IP Properties: IP Address

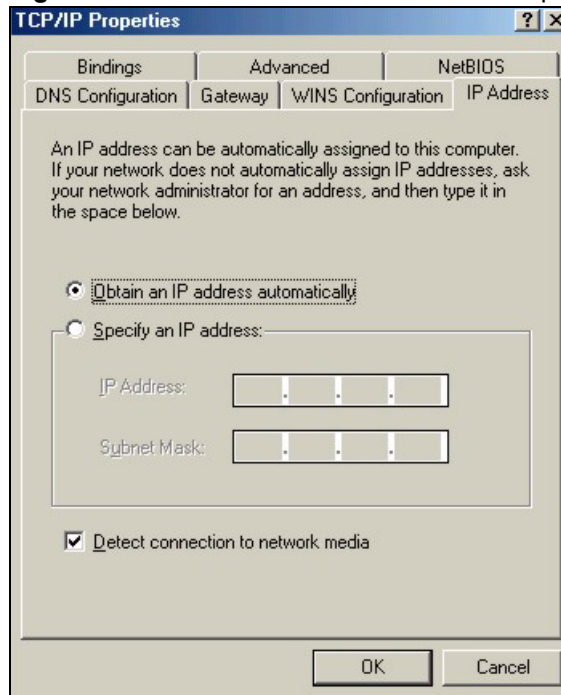

- 3 Click the **DNS Configuration** tab.
 - If you do not know your DNS information, select **Disable DNS**.
 - If you know your DNS information, select **Enable DNS** and type the information in the fields below (you may not need to fill them all in).

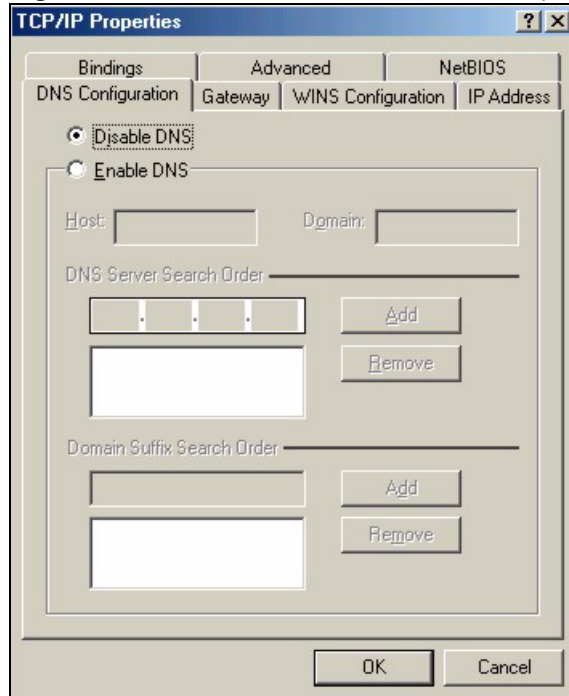
Figure 407 Windows 95/98/Me: TCP/IP Properties: DNS Configuration

- 4 Click the **Gateway** tab.
 - If you do not know your gateway's IP address, remove previously installed gateways.
 - If you have a gateway IP address, type it in the **New gateway field** and click **Add**.
- 5 Click **OK** to save and close the **TCP/IP Properties** window.
- 6 Click **OK** to close the **Network** window. Insert the Windows CD if prompted.
- 7 Turn on your ZyWALL and restart your computer when prompted.

Verifying Settings

- 1 Click **Start** and then **Run**.
- 2 In the **Run** window, type "winipcfg" and then click **OK** to open the **IP Configuration** window.
- 3 Select your network adapter. You should see your computer's IP address, subnet mask and default gateway.

Windows 2000/NT/XP

The following example figures use the default Windows XP GUI theme.

- 1 Click **start** (**Start** in Windows 2000/NT), **Settings**, **Control Panel**.

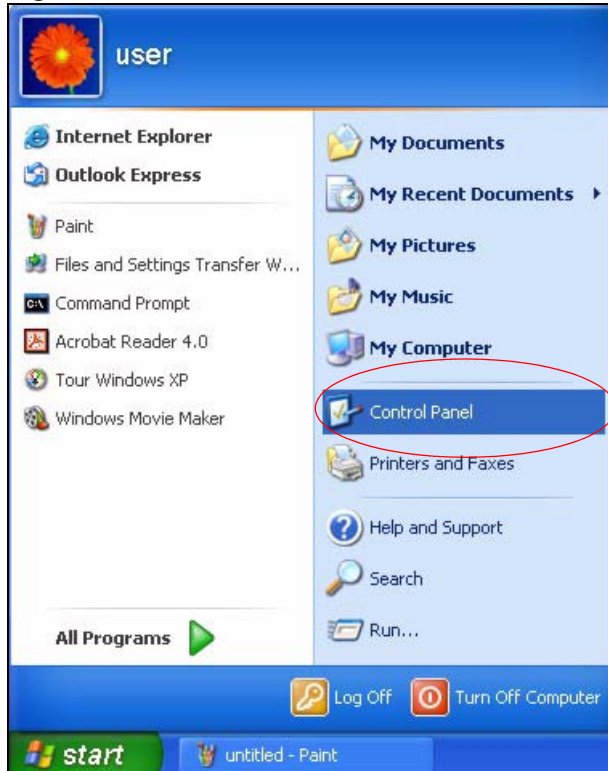
Figure 408 Windows XP: Start Menu

- 2 In the **Control Panel**, double-click **Network Connections** (**Network and Dial-up Connections** in Windows 2000/NT).

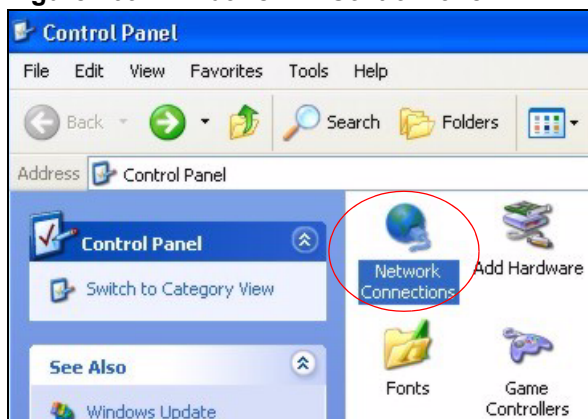
Figure 409 Windows XP: Control Panel

- 3 Right-click **Local Area Connection** and then click **Properties**.

Figure 410 Windows XP: Control Panel: Network Connections: Properties

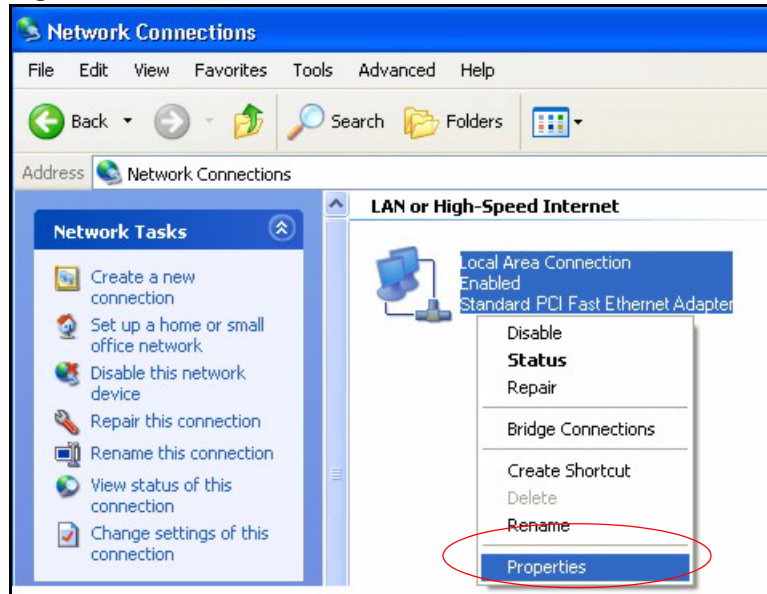

- 4 Select **Internet Protocol (TCP/IP)** (under the **General** tab in Win XP) and then click **Properties**.

Figure 411 Windows XP: Local Area Connection Properties

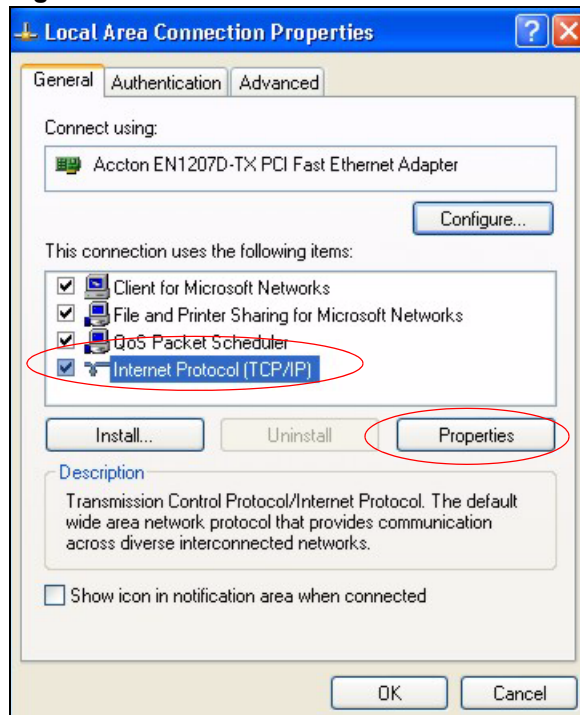

- 5 The **Internet Protocol TCP/IP Properties** window opens (the **General** tab in Windows XP).
 - If you have a dynamic IP address click **Obtain an IP address automatically**.
 - If you have a static IP address click **Use the following IP Address** and fill in the **IP address**, **Subnet mask**, and **Default gateway** fields.
 - Click **Advanced**.

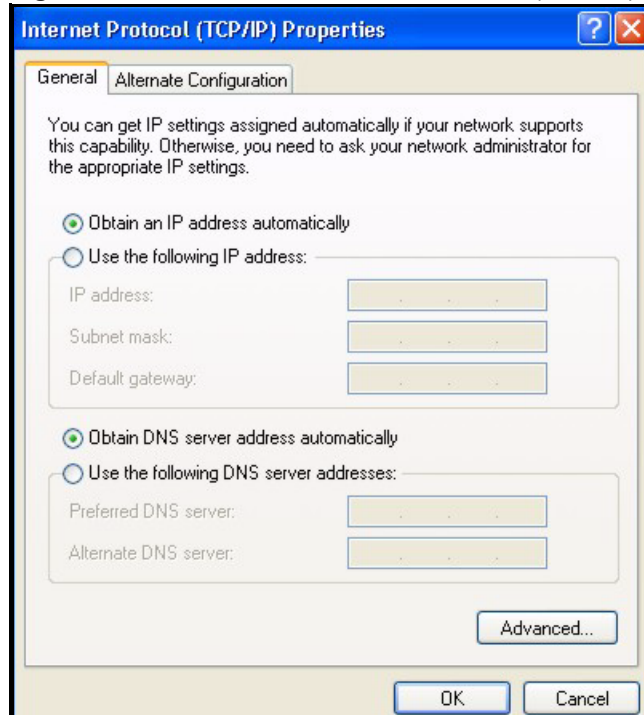
Figure 412 Windows XP: Internet Protocol (TCP/IP) Properties

- 6** If you do not know your gateway's IP address, remove any previously installed gateways in the **IP Settings** tab and click **OK**.

Do one or more of the following if you want to configure additional IP addresses:

- In the **IP Settings** tab, in IP addresses, click **Add**.
- In **TCP/IP Address**, type an IP address in **IP address** and a subnet mask in **Subnet mask**, and then click **Add**.
- Repeat the above two steps for each IP address you want to add.
- Configure additional default gateways in the **IP Settings** tab by clicking **Add** in **Default gateways**.
- In **TCP/IP Gateway Address**, type the IP address of the default gateway in **Gateway**. To manually configure a default metric (the number of transmission hops), clear the **Automatic metric** check box and type a metric in **Metric**.
- Click **Add**.
- Repeat the previous three steps for each default gateway you want to add.
- Click **OK** when finished.

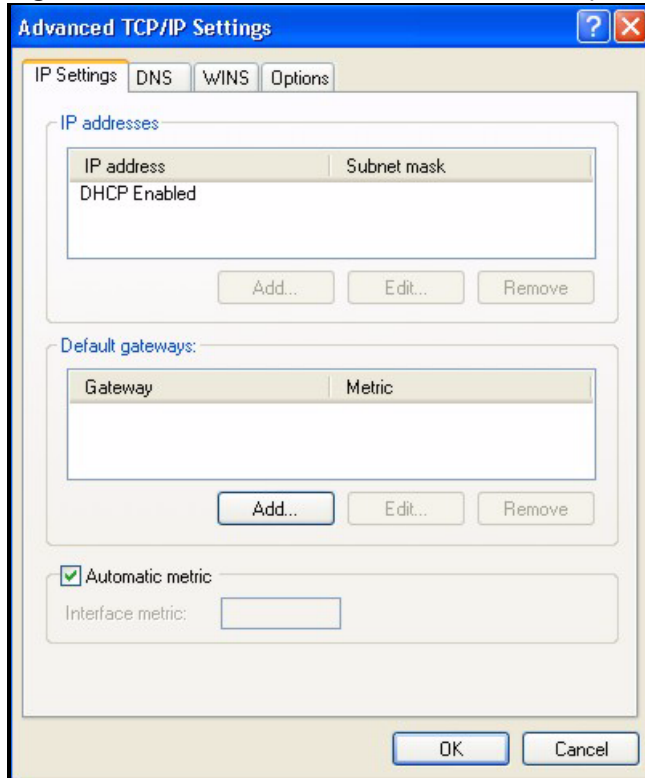
Figure 413 Windows XP: Advanced TCP/IP Properties

- 7** In the **Internet Protocol TCP/IP Properties** window (the **General** tab in Windows XP):
- Click **Obtain DNS server address automatically** if you do not know your DNS server IP address(es).
 - If you know your DNS server IP address(es), click **Use the following DNS server addresses**, and type them in the **Preferred DNS server** and **Alternate DNS server** fields.
- If you have previously configured DNS servers, click **Advanced** and then the **DNS** tab to order them.

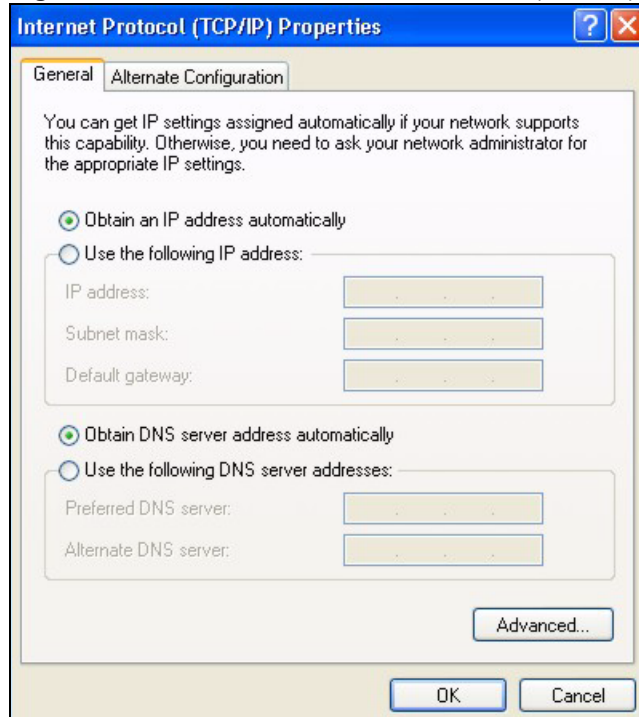
Figure 414 Windows XP: Internet Protocol (TCP/IP) Properties

- 8** Click **OK** to close the **Internet Protocol (TCP/IP) Properties** window.
- 9** Click **Close (OK in Windows 2000/NT)** to close the **Local Area Connection Properties** window.
- 10** Close the **Network Connections** window (**Network and Dial-up Connections** in Windows 2000/NT).
- 11** Turn on your ZyWALL and restart your computer (if prompted).

Verifying Settings

- 1** Click **Start, All Programs, Accessories** and then **Command Prompt**.
- 2** In the **Command Prompt** window, type "ipconfig" and then press [ENTER]. You can also open **Network Connections**, right-click a network connection, click **Status** and then click the **Support** tab.

Macintosh OS 8/9

- 1** Click the **Apple** menu, **Control Panel** and double-click **TCP/IP** to open the **TCP/IP Control Panel**.

Figure 415 Macintosh OS 8/9: Apple Menu

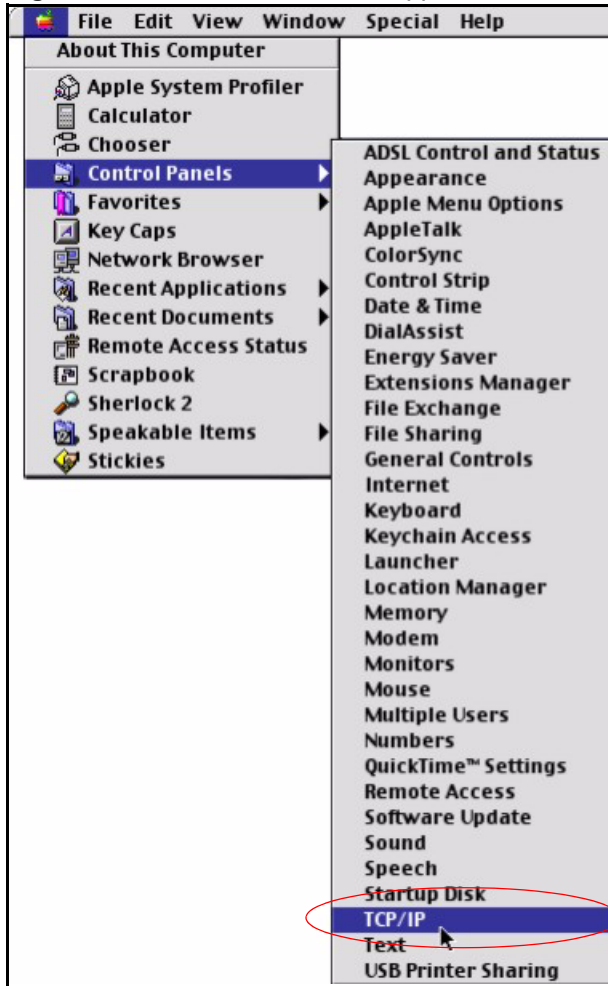

2 Select **Ethernet built-in** from the **Connect via** list.

Figure 416 Macintosh OS 8/9: TCP/IP

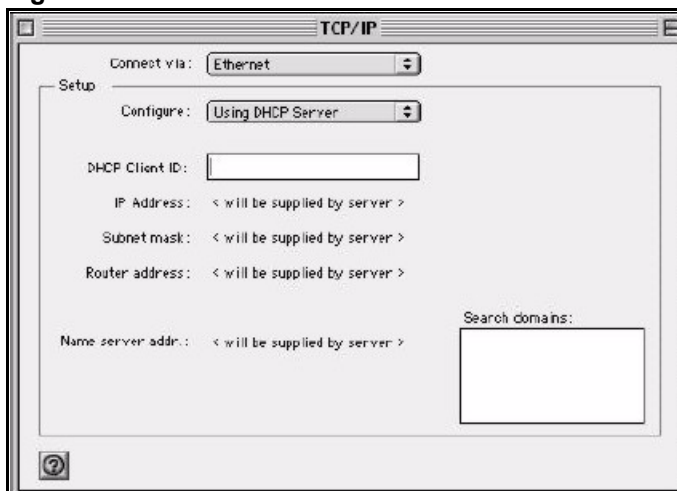

3 For dynamically assigned settings, select **Using DHCP Server** from the **Configure:** list.

4 For statically assigned settings, do the following:

- From the **Configure** box, select **Manually**.
 - Type your IP address in the **IP Address** box.
 - Type your subnet mask in the **Subnet mask** box.
 - Type the IP address of your ZyWALL in the **Router address** box.
- 5 Close the **TCP/IP Control Panel**.
 - 6 Click **Save** if prompted, to save changes to your configuration.
 - 7 Turn on your ZyWALL and restart your computer (if prompted).

Verifying Settings

Check your TCP/IP properties in the **TCP/IP Control Panel** window.

Macintosh OS X

- 1 Click the **Apple** menu, and click **System Preferences** to open the **System Preferences** window.

Figure 417 Macintosh OS X: Apple Menu

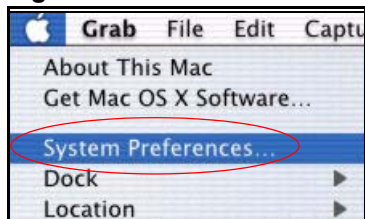

- 2 Click **Network** in the icon bar.
 - Select **Automatic** from the **Location** list.
 - Select **Built-in Ethernet** from the **Show** list.
 - Click the **TCP/IP** tab.
- 3 For dynamically assigned settings, select **Using DHCP** from the **Configure** list.

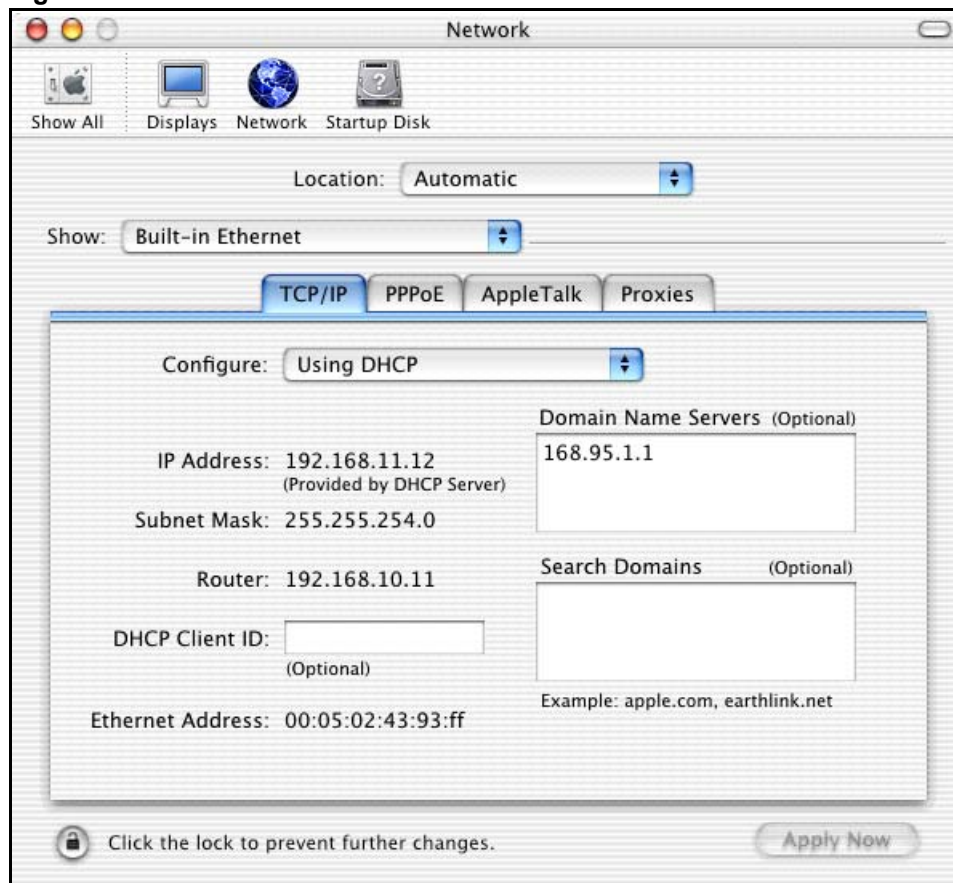
Figure 418 Macintosh OS X: Network

- 4 For statically assigned settings, do the following:
 - From the **Configure** box, select **Manually**.
 - Type your IP address in the **IP Address** box.
 - Type your subnet mask in the **Subnet mask** box.
 - Type the IP address of your ZyWALL in the **Router address** box.
- 5 Click **Apply Now** and close the window.
- 6 Turn on your ZyWALL and restart your computer (if prompted).

Verifying Settings

Check your TCP/IP properties in the **Network** window.

Linux

This section shows you how to configure your computer's TCP/IP settings in Red Hat Linux 9.0. Procedure, screens and file location may vary depending on your Linux distribution and release version.



Make sure you are logged in as the root administrator.

Using the K Desktop Environment (KDE)

Follow the steps below to configure your computer IP address using the KDE.

- 1 Click the Red Hat button (located on the bottom left corner), select **System Setting** and click **Network**.

Figure 419 Red Hat 9.0: KDE: Network Configuration: Devices

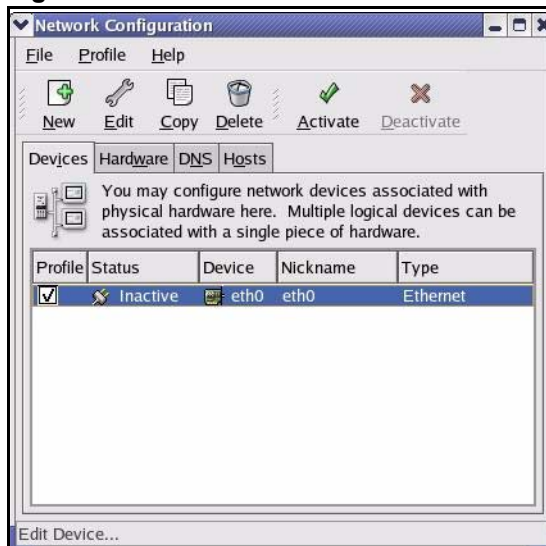

- 2 Double-click on the profile of the network card you wish to configure. The **Ethernet Device General** screen displays as shown.

Figure 420 Red Hat 9.0: KDE: Ethernet Device: General



- If you have a dynamic IP address, click **Automatically obtain IP address settings with** and select **dhcp** from the drop down list.
 - If you have a static IP address, click **Statically set IP Addresses** and fill in the **Address**, **Subnet mask**, and **Default Gateway Address** fields.
- 3 Click **OK** to save the changes and close the **Ethernet Device General** screen.
 - 4 If you know your DNS server IP address(es), click the **DNS** tab in the **Network Configuration** screen. Enter the DNS server information in the fields provided.

Figure 421 Red Hat 9.0: KDE: Network Configuration: DNS

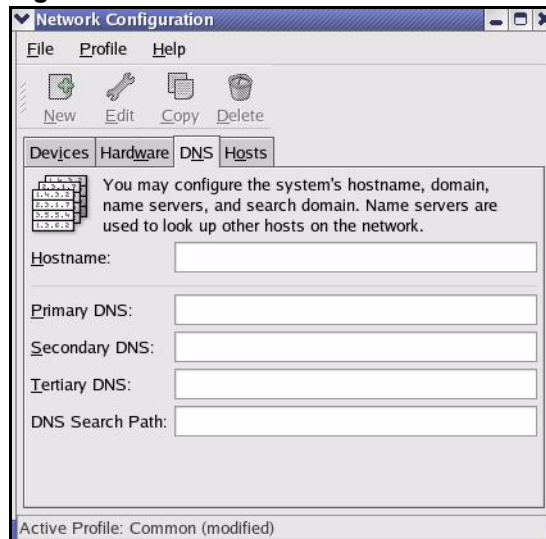

- 5 Click the **Devices** tab.
- 6 Click the **Activate** button to apply the changes. The following screen displays. Click **Yes to save the changes in all screens**.

Figure 422 Red Hat 9.0: KDE: Network Configuration: Activate

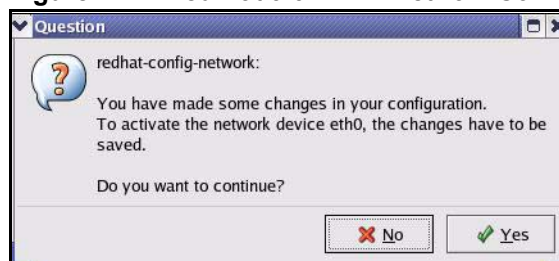

- 7 After the network card restart process is complete, make sure the **Status** is **Active** in the **Network Configuration** screen.

Using Configuration Files

Follow the steps below to edit the network configuration files and set your computer IP address.

- 1 Assuming that you have only one network card on the computer, locate the `ifconfig-eth0` configuration file (where `eth0` is the name of the Ethernet card). Open the configuration file with any plain text editor.
 - If you have a dynamic IP address, enter **dhcp** in the `BOOTPROTO=` field. The following figure shows an example.

Figure 423 Red Hat 9.0: Dynamic IP Address Setting in ifconfig-eth0

```
DEVICE=eth0
ONBOOT=yes
BOOTPROTO=dhcp
USERCTL=no
PEERDNS=yes
TYPE=Ethernet
```

- If you have a static IP address, enter **static** in the `BOOTPROTO=` field. Type `IPADDR=` followed by the IP address (in dotted decimal notation) and type `NETMASK=` followed by the subnet mask. The following example shows an example where the static IP address is 192.168.1.10 and the subnet mask is 255.255.255.0.

Figure 424 Red Hat 9.0: Static IP Address Setting in ifconfig-eth0

```
DEVICE=eth0
ONBOOT=yes
BOOTPROTO=static
IPADDR=192.168.1.10
NETMASK=255.255.255.0
USERCTL=no
PEERDNS=yes
TYPE=Ethernet
```

- 2 If you know your DNS server IP address(es), enter the DNS server information in the `resolv.conf` file in the `/etc` directory. The following figure shows an example where two DNS server IP addresses are specified.

Figure 425 Red Hat 9.0: DNS Settings in resolv.conf

```
nameserver 172.23.5.1
nameserver 172.23.5.2
```

- 3 After you edit and save the configuration files, you must restart the network card. Enter `./network restart` in the `/etc/rc.d/init.d` directory. The following figure shows an example.

Figure 426 Red Hat 9.0: Restart Ethernet Card

```
[root@localhost init.d]# network restart

Shutting down interface eth0:           [OK]
Shutting down loopback interface:       [OK]
Setting network parameters:            [OK]
Bringing up loopback interface:         [OK]
Bringing up interface eth0:             [OK]
```

Verifying Settings

Enter `ifconfig` in a terminal screen to check your TCP/IP properties.

Figure 427 Red Hat 9.0: Checking TCP/IP Properties

```
[root@localhost]# ifconfig
eth0      Link encap:Ethernet  HWaddr 00:50:BA:72:5B:44
          inet addr:172.23.19.129  Bcast:172.23.19.255  Mask:255.255.255.0
          UP BROADCAST RUNNING MULTICAST  MTU:1500  Metric:1
          RX packets:717 errors:0 dropped:0 overruns:0 frame:0
          TX packets:13 errors:0 dropped:0 overruns:0 carrier:0
          collisions:0 txqueuelen:100
          RX bytes:730412 (713.2 Kb)  TX bytes:1570 (1.5 Kb)
          Interrupt:10 Base address:0x1000
[root@localhost]#
```

Pop-up Windows, JavaScripts and Java Permissions

In order to use the web configurator you need to allow:

- Web browser pop-up windows from your device.
- JavaScripts (enabled by default).
- Java permissions (enabled by default).



Internet Explorer 6 screens are used here. Screens for other Internet Explorer versions may vary.

Internet Explorer Pop-up Blockers

You may have to disable pop-up blocking to log into your device.

Either disable pop-up blocking (enabled by default in Windows XP SP (Service Pack) 2) or allow pop-up blocking and create an exception for your device's IP address.

Disable pop-up Blockers

- 1 In Internet Explorer, select **Tools, Pop-up Blocker** and then select **Turn Off Pop-up Blocker**.

Figure 428 Pop-up Blocker

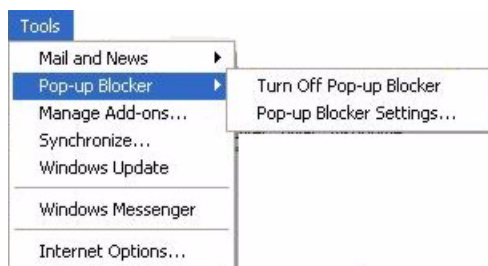

You can also check if pop-up blocking is disabled in the **Pop-up Blocker** section in the **Privacy** tab.

- 1 In Internet Explorer, select **Tools, Internet Options, Privacy**.

- 2 Clear the **Block pop-ups** check box in the **Pop-up Blocker** section of the screen. This disables any web pop-up blockers you may have enabled.

Figure 429 Internet Options

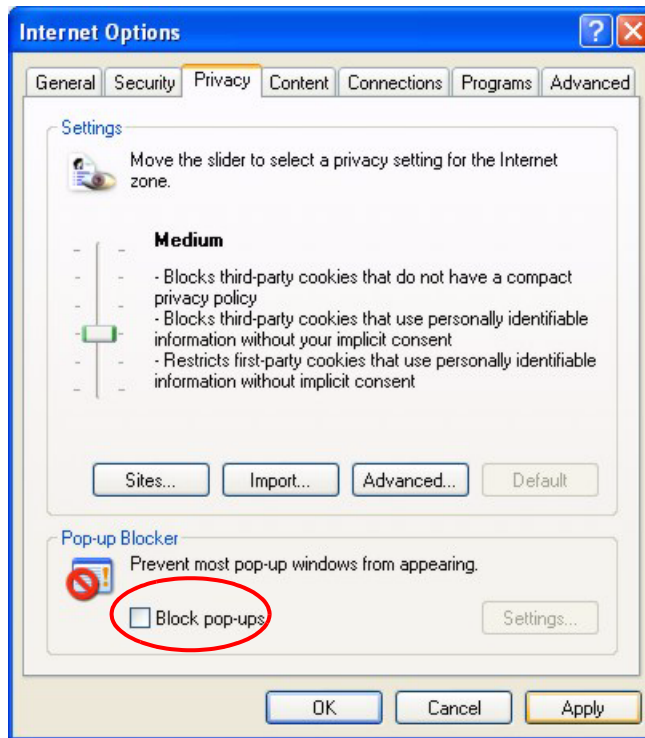

- 3 Click **Apply** to save this setting.

Enable pop-up Blockers with Exceptions

Alternatively, if you only want to allow pop-up windows from your device, see the following steps.

- 1 In Internet Explorer, select **Tools, Internet Options** and then the **Privacy** tab.
- 2 Select **Settings...** to open the **Pop-up Blocker Settings** screen.

Figure 430 Internet Options

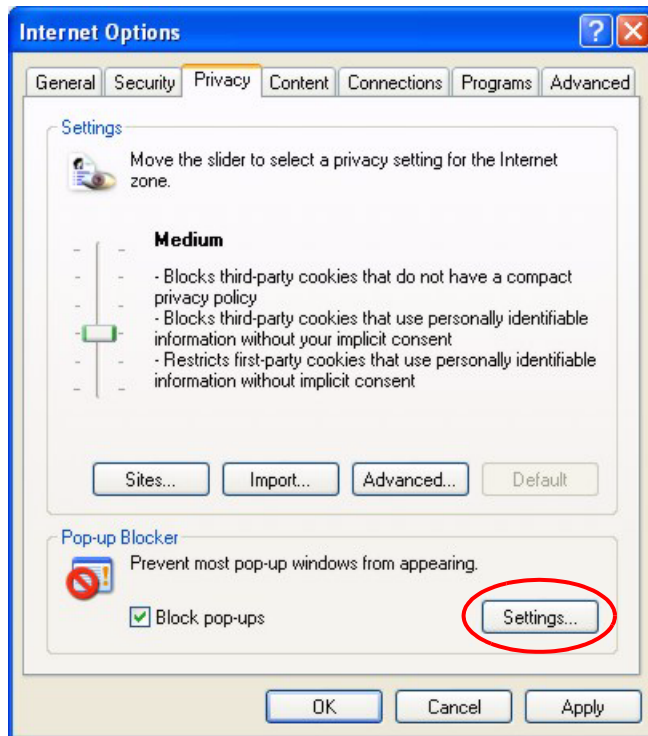

- 3 Type the IP address of your device (the web page that you do not want to have blocked) with the prefix "http://". For example, http://192.168.1.1.
- 4 Click **Add** to move the IP address to the list of **Allowed sites**.

Figure 431 Pop-up Blocker Settings

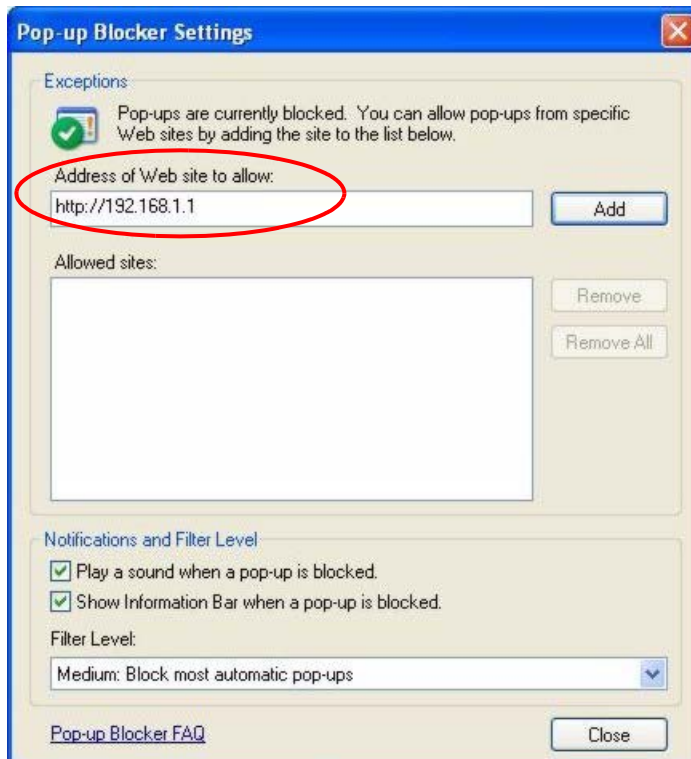

- 5 Click **Close** to return to the **Privacy** screen.
- 6 Click **Apply** to save this setting.

JavaScripts

If pages of the web configurator do not display properly in Internet Explorer, check that JavaScripts are allowed.

- 1 In Internet Explorer, click **Tools, Internet Options** and then the **Security** tab.

Figure 432 Internet Options

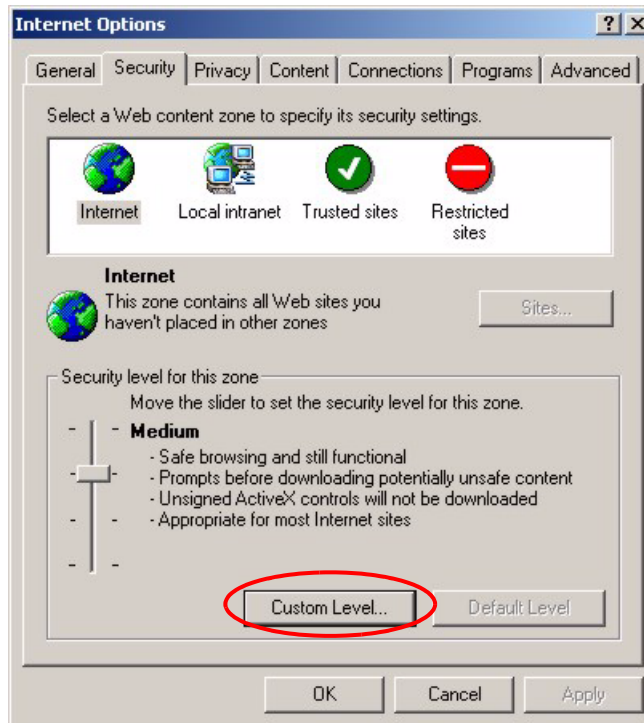

- 2 Click the **Custom Level...** button.
- 3 Scroll down to **Scripting**.
- 4 Under **Active scripting** make sure that **Enable** is selected (the default).
- 5 Under **Scripting of Java applets** make sure that **Enable** is selected (the default).
- 6 Click **OK** to close the window.

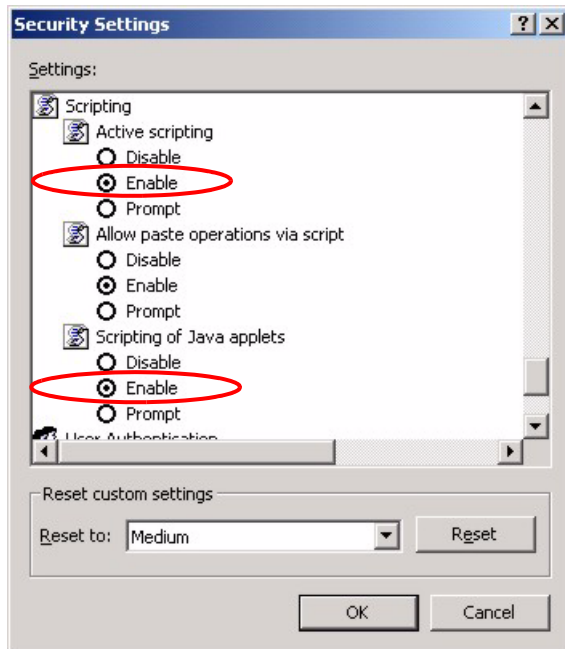
Figure 433 Security Settings - Java Scripting

Java Permissions

- 1 From Internet Explorer, click **Tools, Internet Options** and then the **Security** tab.
- 2 Click the **Custom Level...** button.
- 3 Scroll down to **Microsoft VM**.
- 4 Under **Java permissions** make sure that a safety level is selected.
- 5 Click **OK** to close the window.

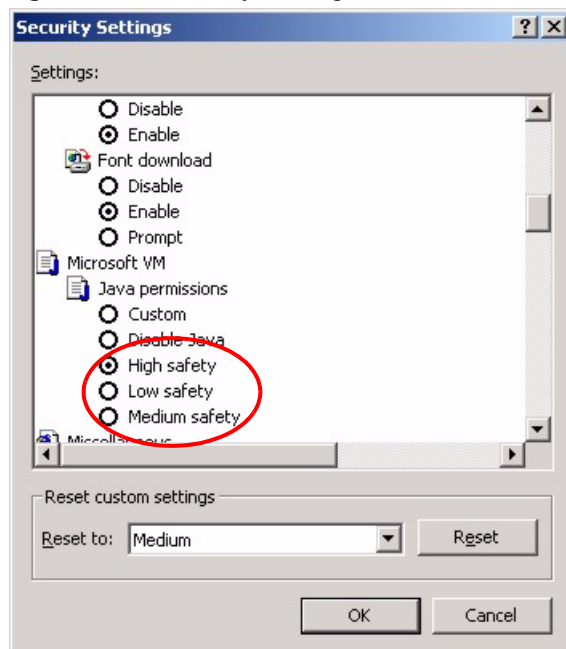
Figure 434 Security Settings - Java

JAVA (Sun)

- 1 From Internet Explorer, click **Tools, Internet Options** and then the **Advanced** tab.
- 2 make sure that **Use Java 2 for <applet>** under **Java (Sun)** is selected.
- 3 Click **OK** to close the window.

Figure 435 Java (Sun)

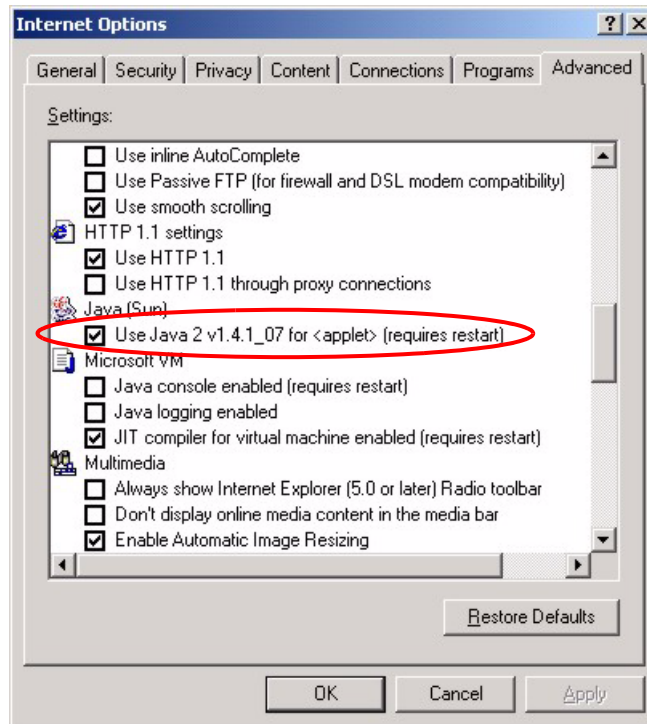

IP Addresses and Subnetting

This appendix introduces IP addresses and subnet masks.

IP addresses identify individual devices on a network. Every networking device (including computers, servers, routers, printers, etc.) needs an IP address to communicate across the network. These networking devices are also known as hosts.

Subnet masks determine the maximum number of possible hosts on a network. You can also use subnet masks to divide one network into multiple sub-networks.

Introduction to IP Addresses

One part of the IP address is the network number, and the other part is the host ID. In the same way that houses on a street share a common street name, the hosts on a network share a common network number. Similarly, as each house has its own house number, each host on the network has its own unique identifying number - the host ID. Routers use the network number to send packets to the correct network, while the host ID determines to which host on the network the packets are delivered.

Structure

An IP address is made up of four parts, written in dotted decimal notation (for example, 192.168.1.1). Each of these four parts is known as an octet. An octet is an eight-digit binary number (for example 11000000, which is 192 in decimal notation).

Therefore, each octet has a possible range of 00000000 to 11111111 in binary, or 0 to 255 in decimal.

The following figure shows an example IP address in which the first three octets (192.168.1) are the network number, and the fourth octet (16) is the host ID.

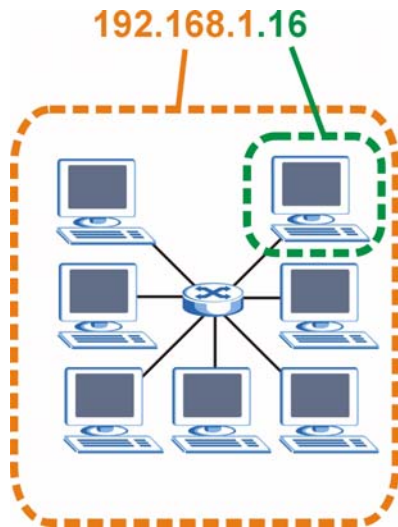
Figure 436 Network Number and Host ID

How much of the IP address is the network number and how much is the host ID varies according to the subnet mask.

Subnet Masks

A subnet mask is used to determine which bits are part of the network number, and which bits are part of the host ID (using a logical AND operation). The term “subnet” is short for “sub-network”.

A subnet mask has 32 bits. If a bit in the subnet mask is a “1” then the corresponding bit in the IP address is part of the network number. If a bit in the subnet mask is “0” then the corresponding bit in the IP address is part of the host ID.

The following example shows a subnet mask identifying the network number (in bold text) and host ID of an IP address (192.168.1.2 in decimal).

Table 219

	1ST OCTET: (192)	2ND OCTET: (168)	3RD OCTET: (1)	4TH OCTET (2)
IP Address (Binary)	11000000	10101000	00000001	00000010
Subnet Mask (Binary)	11111111	11111111	11111111	00000000
Network Number	11000000	10101000	00000001	
Host ID				00000010

By convention, subnet masks always consist of a continuous sequence of ones beginning from the leftmost bit of the mask, followed by a continuous sequence of zeros, for a total number of 32 bits.

Subnet masks can be referred to by the size of the network number part (the bits with a “1” value). For example, an “8-bit mask” means that the first 8 bits of the mask are ones and the remaining 24 bits are zeroes.

Subnet masks are expressed in dotted decimal notation just like IP addresses. The following examples show the binary and decimal notation for 8-bit, 16-bit, 24-bit and 29-bit subnet masks.

Table 220 Subnet Masks

	BINARY				DECIMAL
	1ST OCTET	2ND OCTET	3RD OCTET	4TH OCTET	
8-bit mask	11111111	00000000	00000000	00000000	255.0.0.0
16-bit mask	11111111	11111111	00000000	00000000	255.255.0.0
24-bit mask	11111111	11111111	11111111	00000000	255.255.255.0
29-bit mask	11111111	11111111	11111111	11111000	255.255.255.248

Network Size

The size of the network number determines the maximum number of possible hosts you can have on your network. The larger the number of network number bits, the smaller the number of remaining host ID bits.

An IP address with host IDs of all zeros is the IP address of the network (192.168.1.0 with a 24-bit subnet mask, for example). An IP address with host IDs of all ones is the broadcast address for that network (192.168.1.255 with a 24-bit subnet mask, for example).

As these two IP addresses cannot be used for individual hosts, calculate the maximum number of possible hosts in a network as follows:

Table 221 Maximum Host Numbers

SUBNET MASK		HOST ID SIZE		MAXIMUM NUMBER OF HOSTS
8 bits	255.0.0.0	24 bits	$2^{24} - 2$	16777214
16 bits	255.255.0.0	16 bits	$2^{16} - 2$	65534
24 bits	255.255.255.0	8 bits	$2^8 - 2$	254
29 bits	255.255.255.248	3 bits	$2^3 - 2$	6

Notation

Since the mask is always a continuous number of ones beginning from the left, followed by a continuous number of zeros for the remainder of the 32 bit mask, you can simply specify the number of ones instead of writing the value of each octet. This is usually specified by writing a “/” followed by the number of bits in the mask after the address.

For example, 192.1.1.0 /25 is equivalent to saying 192.1.1.0 with subnet mask 255.255.255.128.

The following table shows some possible subnet masks using both notations.

Table 222 Alternative Subnet Mask Notation

SUBNET MASK	ALTERNATIVE NOTATION	LAST OCTET (BINARY)	LAST OCTET (DECIMAL)
255.255.255.0	/24	0000 0000	0
255.255.255.128	/25	1000 0000	128

Table 222 Alternative Subnet Mask Notation (continued)

SUBNET MASK	ALTERNATIVE NOTATION	LAST OCTET (BINARY)	LAST OCTET (DECIMAL)
255.255.255.192	/26	1100 0000	192
255.255.255.224	/27	1110 0000	224
255.255.255.240	/28	1111 0000	240
255.255.255.248	/29	1111 1000	248
255.255.255.252	/30	1111 1100	252

Subnetting

You can use subnetting to divide one network into multiple sub-networks. In the following example a network administrator creates two sub-networks to isolate a group of servers from the rest of the company network for security reasons.

In this example, the company network address is 192.168.1.0. The first three octets of the address (192.168.1) are the network number, and the remaining octet is the host ID, allowing a maximum of $2^8 - 2$ or 254 possible hosts.

The following figure shows the company network before subnetting.

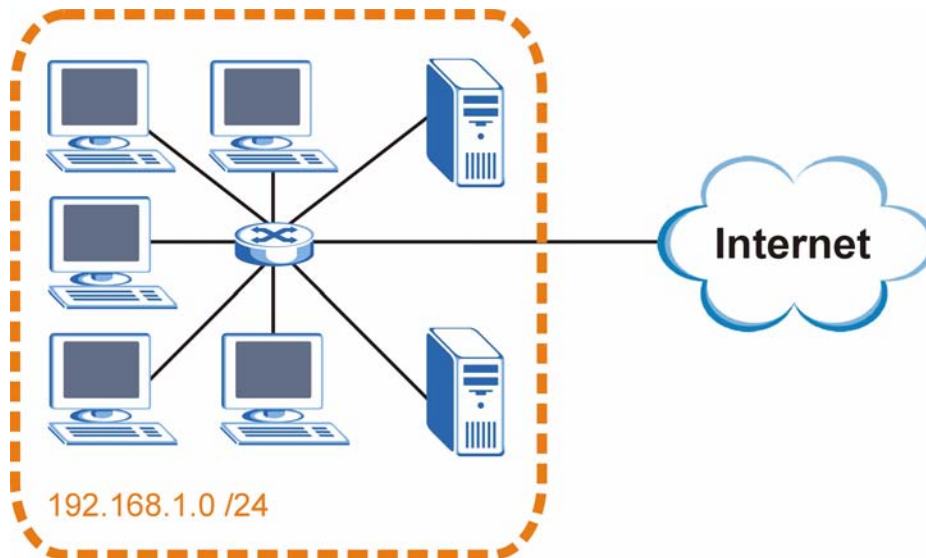
Figure 437 Subnetting Example: Before Subnetting

You can “borrow” one of the host ID bits to divide the network 192.168.1.0 into two separate sub-networks. The subnet mask is now 25 bits (255.255.255.128 or /25).

The “borrowed” host ID bit can have a value of either 0 or 1, allowing two subnets; 192.168.1.0 /25 and 192.168.1.128 /25.

The following figure shows the company network after subnetting. There are now two sub-networks, **A** and **B**.

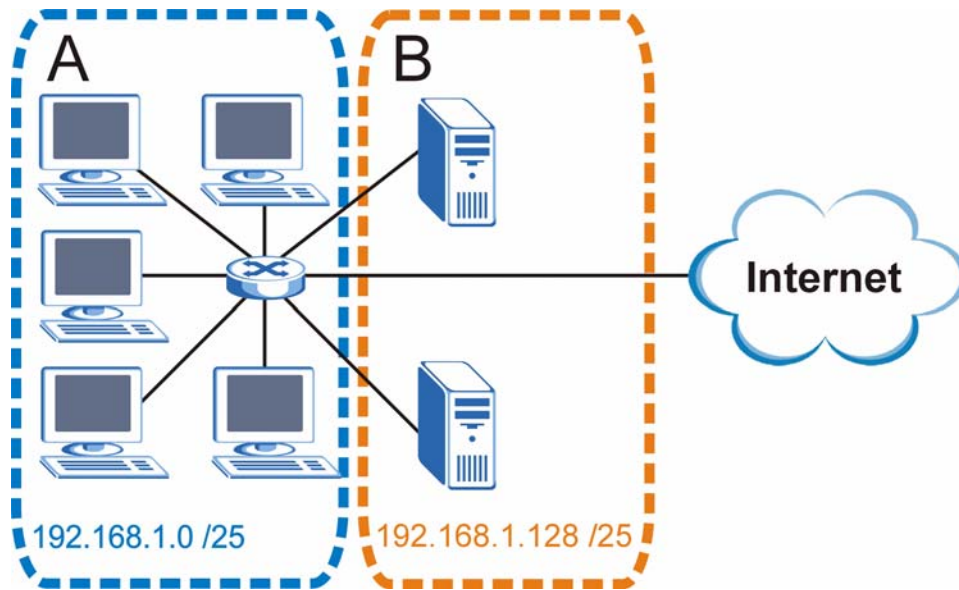
Figure 438 Subnetting Example: After Subnetting

In a 25-bit subnet the host ID has 7 bits, so each sub-network has a maximum of $2^7 - 2$ or 126 possible hosts (a host ID of all zeroes is the subnet's address itself, all ones is the subnet's broadcast address).

192.168.1.0 with mask 255.255.255.128 is subnet **A** itself, and 192.168.1.127 with mask 255.255.255.128 is its broadcast address. Therefore, the lowest IP address that can be assigned to an actual host for subnet **A** is 192.168.1.1 and the highest is 192.168.1.126.

Similarly, the host ID range for subnet **B** is 192.168.1.129 to 192.168.1.254.

Example: Four Subnets

The previous example illustrated using a 25-bit subnet mask to divide a 24-bit address into two subnets. Similarly, to divide a 24-bit address into four subnets, you need to “borrow” two host ID bits to give four possible combinations (00, 01, 10 and 11). The subnet mask is 26 bits (11111111.11111111.11111111.11000000) or 255.255.255.192.

Each subnet contains 6 host ID bits, giving $2^6 - 2$ or 62 hosts for each subnet (a host ID of all zeroes is the subnet itself, all ones is the subnet's broadcast address).

Table 223 Subnet 1

IP/SUBNET MASK	NETWORK NUMBER	LAST OCTET BIT VALUE
IP Address (Decimal)	192.168.1.	0
IP Address (Binary)	11000000.10101000.00000001.	00000000
Subnet Mask (Binary)	11111111.11111111.11111111.	11000000
Subnet Address: 192.168.1.0	Lowest Host ID: 192.168.1.1	
Broadcast Address: 192.168.1.63	Highest Host ID: 192.168.1.62	

Table 224 Subnet 2

IP/SUBNET MASK	NETWORK NUMBER	LAST OCTET BIT VALUE
IP Address	192.168.1.	64
IP Address (Binary)	11000000.10101000.00000001.	01000000
Subnet Mask (Binary)	11111111.11111111.11111111.	11000000
Subnet Address: 192.168.1.64	Lowest Host ID: 192.168.1.65	
Broadcast Address: 192.168.1.127	Highest Host ID: 192.168.1.126	

Table 225 Subnet 3

IP/SUBNET MASK	NETWORK NUMBER	LAST OCTET BIT VALUE
IP Address	192.168.1.	128
IP Address (Binary)	11000000.10101000.00000001.	10000000
Subnet Mask (Binary)	11111111.11111111.11111111.	11000000
Subnet Address: 192.168.1.128	Lowest Host ID: 192.168.1.129	
Broadcast Address: 192.168.1.191	Highest Host ID: 192.168.1.190	

Table 226 Subnet 4

IP/SUBNET MASK	NETWORK NUMBER	LAST OCTET BIT VALUE
IP Address	192.168.1.	192
IP Address (Binary)	11000000.10101000.00000001.	11000000
Subnet Mask (Binary)	11111111.11111111.11111111.	11000000
Subnet Address: 192.168.1.192	Lowest Host ID: 192.168.1.193	
Broadcast Address: 192.168.1.255	Highest Host ID: 192.168.1.254	

Example: Eight Subnets

Similarly, use a 27-bit mask to create eight subnets (000, 001, 010, 011, 100, 101, 110 and 111).

The following table shows IP address last octet values for each subnet.

Table 227 Eight Subnets

SUBNET	SUBNET ADDRESS	FIRST ADDRESS	LAST ADDRESS	BROADCAST ADDRESS
1	0	1	30	31
2	32	33	62	63
3	64	65	94	95
4	96	97	126	127

Table 227 Eight Subnets (continued)

SUBNET	SUBNET ADDRESS	FIRST ADDRESS	LAST ADDRESS	BROADCAST ADDRESS
5	128	129	158	159
6	160	161	190	191
7	192	193	222	223
8	224	225	254	255

Subnet Planning

The following table is a summary for subnet planning on a network with a 24-bit network number.

Table 228 24-bit Network Number Subnet Planning

NO. "BORROWED" HOST BITS	SUBNET MASK	NO. SUBNETS	NO. HOSTS PER SUBNET
1	255.255.255.128 (/25)	2	126
2	255.255.255.192 (/26)	4	62
3	255.255.255.224 (/27)	8	30
4	255.255.255.240 (/28)	16	14
5	255.255.255.248 (/29)	32	6
6	255.255.255.252 (/30)	64	2
7	255.255.255.254 (/31)	128	1

The following table is a summary for subnet planning on a network with a 16-bit network number.

Table 229 16-bit Network Number Subnet Planning

NO. "BORROWED" HOST BITS	SUBNET MASK	NO. SUBNETS	NO. HOSTS PER SUBNET
1	255.255.128.0 (/17)	2	32766
2	255.255.192.0 (/18)	4	16382
3	255.255.224.0 (/19)	8	8190
4	255.255.240.0 (/20)	16	4094
5	255.255.248.0 (/21)	32	2046
6	255.255.252.0 (/22)	64	1022
7	255.255.254.0 (/23)	128	510
8	255.255.255.0 (/24)	256	254
9	255.255.255.128 (/25)	512	126
10	255.255.255.192 (/26)	1024	62
11	255.255.255.224 (/27)	2048	30
12	255.255.255.240 (/28)	4096	14
13	255.255.255.248 (/29)	8192	6

Table 229 16-bit Network Number Subnet Planning (continued)

NO. "BORROWED" HOST BITS	SUBNET MASK	NO. SUBNETS	NO. HOSTS PER SUBNET
14	255.255.255.252 (/30)	16384	2
15	255.255.255.254 (/31)	32768	1

Configuring IP Addresses

Where you obtain your network number depends on your particular situation. If the ISP or your network administrator assigns you a block of registered IP addresses, follow their instructions in selecting the IP addresses and the subnet mask.

If the ISP did not explicitly give you an IP network number, then most likely you have a single user account and the ISP will assign you a dynamic IP address when the connection is established. If this is the case, it is recommended that you select a network number from 192.168.0.0 to 192.168.255.0. The Internet Assigned Number Authority (IANA) reserved this block of addresses specifically for private use; please do not use any other number unless you are told otherwise. You must also enable Network Address Translation (NAT) on the ZyWALL.

Once you have decided on the network number, pick an IP address for your ZyWALL that is easy to remember (for instance, 192.168.1.1) but make sure that no other device on your network is using that IP address.

The subnet mask specifies the network number portion of an IP address. Your ZyWALL will compute the subnet mask automatically based on the IP address that you entered. You don't need to change the subnet mask computed by the ZyWALL unless you are instructed to do otherwise.

Private IP Addresses

Every machine on the Internet must have a unique address. If your networks are isolated from the Internet (running only between two branch offices, for example) you can assign any IP addresses to the hosts without problems. However, the Internet Assigned Numbers Authority (IANA) has reserved the following three blocks of IP addresses specifically for private networks:

- 10.0.0.0 — 10.255.255.255
- 172.16.0.0 — 172.31.255.255
- 192.168.0.0 — 192.168.255.255

You can obtain your IP address from the IANA, from an ISP, or it can be assigned from a private network. If you belong to a small organization and your Internet access is through an ISP, the ISP can provide you with the Internet addresses for your local networks. On the other hand, if you are part of a much larger organization, you should consult your network administrator for the appropriate IP addresses.

Regardless of your particular situation, do not create an arbitrary IP address; always follow the guidelines above. For more information on address assignment, please refer to RFC 1597, *Address Allocation for Private Internets* and RFC 1466, *Guidelines for Management of IP Address Space*.

Common Services

The following table lists some commonly-used services and their associated protocols and port numbers. For a comprehensive list of port numbers, ICMP type/code numbers and services, visit the IANA (Internet Assigned Number Authority) web site.

- **Name:** This is a short, descriptive name for the service. You can use this one or create a different one, if you like.
- **Protocol:** This is the type of IP protocol used by the service. If this is **TCP/UDP**, then the service uses the same port number with TCP and UDP. If this is **USER-DEFINED**, the **Port(s)** is the IP protocol number, not the port number.
- **Port(s):** This value depends on the **Protocol**. Please refer to RFC 1700 for further information about port numbers.
 - If the **Protocol** is **TCP, UDP, or TCP/UDP**, this is the IP port number.
 - If the **Protocol** is **USER**, this is the IP protocol number.
- **Description:** This is a brief explanation of the applications that use this service or the situations in which this service is used.

Table 230 Commonly Used Services

NAME	PROTOCOL	PORT(S)	DESCRIPTION
AH (IPSEC_TUNNEL)	User-Defined	51	The IPSEC AH (Authentication Header) tunneling protocol uses this service.
AIM/New-ICQ	TCP	5190	AOL's Internet Messenger service. It is also used as a listening port by ICQ.
AUTH	TCP	113	Authentication protocol used by some servers.
BGP	TCP	179	Border Gateway Protocol.
BOOTP_CLIENT	UDP	68	DHCP Client.
BOOTP_SERVER	UDP	67	DHCP Server.
CU-SEEME	TCP UDP	7648 24032	A popular videoconferencing solution from White Pines Software.
DNS	TCP/UDP	53	Domain Name Server, a service that matches web names (e.g. www.zyxel.com) to IP numbers.
ESP (IPSEC_TUNNEL)	User-Defined	50	The IPSEC ESP (Encapsulation Security Protocol) tunneling protocol uses this service.
FINGER	TCP	79	Finger is a UNIX or Internet related command that can be used to find out if a user is logged on.

Table 230 Commonly Used Services (continued)

NAME	PROTOCOL	PORT(S)	DESCRIPTION
FTP	TCP TCP	20 21	File Transfer Program, a program to enable fast transfer of files, including large files that may not be possible by e-mail.
H.323	TCP	1720	NetMeeting uses this protocol.
HTTP	TCP	80	Hyper Text Transfer Protocol - a client/server protocol for the world wide web.
HTTPS	TCP	443	HTTPS is a secured http session often used in e-commerce.
ICMP	User-Defined	1	Internet Control Message Protocol is often used for diagnostic or routing purposes.
ICQ	UDP	4000	This is a popular Internet chat program.
IGMP (MULTICAST)	User-Defined	2	Internet Group Multicast Protocol is used when sending packets to a specific group of hosts.
IKE	UDP	500	The Internet Key Exchange algorithm is used for key distribution and management.
IRC	TCP/UDP	6667	This is another popular Internet chat program.
MSN Messenger	TCP	1863	Microsoft Networks' messenger service uses this protocol.
NEW-ICQ	TCP	5190	An Internet chat program.
NEWS	TCP	144	A protocol for news groups.
NFS	UDP	2049	Network File System - NFS is a client/server distributed file service that provides transparent file sharing for network environments.
NNTP	TCP	119	Network News Transport Protocol is the delivery mechanism for the USENET newsgroup service.
PING	User-Defined	1	Packet INternet Groper is a protocol that sends out ICMP echo requests to test whether or not a remote host is reachable.
POP3	TCP	110	Post Office Protocol version 3 lets a client computer get e-mail from a POP3 server through a temporary connection (TCP/IP or other).
PPTP	TCP	1723	Point-to-Point Tunneling Protocol enables secure transfer of data over public networks. This is the control channel.
PPTP_TUNNEL (GRE)	User-Defined	47	PPTP (Point-to-Point Tunneling Protocol) enables secure transfer of data over public networks. This is the data channel.
RCMD	TCP	512	Remote Command Service.
REAL_AUDIO	TCP	7070	A streaming audio service that enables real time sound over the web.
REXEC	TCP	514	Remote Execution Daemon.
RLOGIN	TCP	513	Remote Login.

Table 230 Commonly Used Services (continued)

NAME	PROTOCOL	PORT(S)	DESCRIPTION
RTELNET	TCP	107	Remote Telnet.
RTSP	TCP/UDP	554	The Real Time Streaming (media control) Protocol (RTSP) is a remote control for multimedia on the Internet.
SFTP	TCP	115	Simple File Transfer Protocol.
SMTP	TCP	25	Simple Mail Transfer Protocol is the message-exchange standard for the Internet. SMTP enables you to move messages from one e-mail server to another.
SNMP	TCP/UDP	161	Simple Network Management Program.
SNMP-TRAPS	TCP/UDP	162	Traps for use with the SNMP (RFC:1215).
SQL-NET	TCP	1521	Structured Query Language is an interface to access data on many different types of database systems, including mainframes, midrange systems, UNIX systems and network servers.
SSH	TCP/UDP	22	Secure Shell Remote Login Program.
STRM WORKS	UDP	1558	Stream Works Protocol.
SYSLOG	UDP	514	Syslog allows you to send system logs to a UNIX server.
TACACS	UDP	49	Login Host Protocol used for (Terminal Access Controller Access Control System).
TELNET	TCP	23	Telnet is the login and terminal emulation protocol common on the Internet and in UNIX environments. It operates over TCP/IP networks. Its primary function is to allow users to log into remote host systems.
TFTP	UDP	69	Trivial File Transfer Protocol is an Internet file transfer protocol similar to FTP, but uses the UDP (User Datagram Protocol) rather than TCP (Transmission Control Protocol).
VDOLIVE	TCP	7000	Another videoconferencing solution.

Importing Certificates

This appendix shows importing certificates examples using Internet Explorer 5.

Import ZyWALL Certificates into Netscape Navigator

In Netscape Navigator, you can permanently trust the ZyWALL's server certificate by importing it into your operating system as a trusted certification authority.

Select **Accept This Certificate Permanently** in the following screen to do this.

Figure 439 Security Certificate



Importing the ZyWALL's Certificate into Internet Explorer

For Internet Explorer to trust a self-signed certificate from the ZyWALL, simply import the self-signed certificate into your operating system as a trusted certification authority.

To have Internet Explorer trust a ZyWALL certificate issued by a certificate authority, import the certificate authority's certificate into your operating system as a trusted certification authority.

The following example procedure shows how to import the ZyWALL's (self-signed) server certificate into your operating system as a trusted certification authority.

- 1 In Internet Explorer, double click the lock shown in the following screen.

Figure 440 Login Screen



2 Click **Install Certificate** to open the **Install Certificate** wizard.

Figure 441 Certificate General Information before Import



3 Click **Next** to begin the **Install Certificate** wizard.

Figure 442 Certificate Import Wizard 1



- 4 Select where you would like to store the certificate and then click **Next**.

Figure 443 Certificate Import Wizard 2

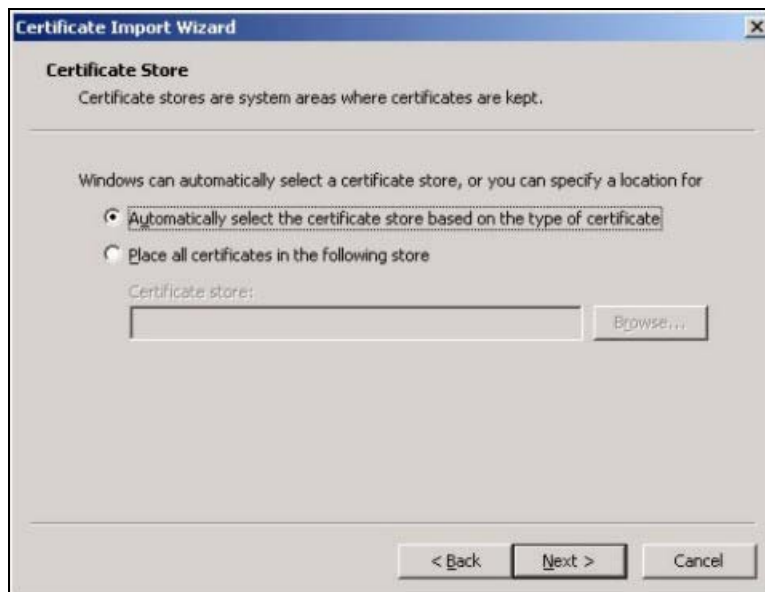

- 5 Click **Finish** to complete the **Import Certificate** wizard.

Figure 444 Certificate Import Wizard 3



6 Click **Yes** to add the ZyWALL certificate to the root store.

Figure 445 Root Certificate Store

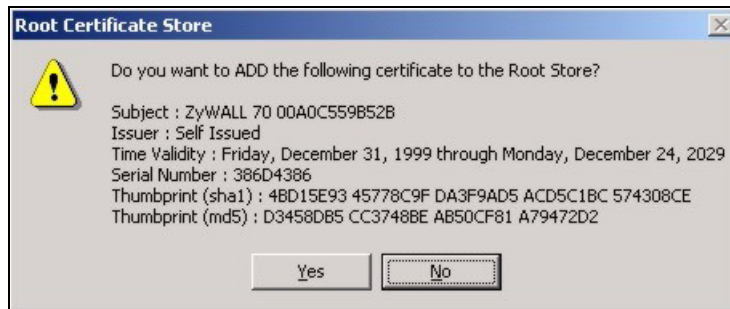

Figure 446 Certificate General Information after Import

Enrolling and Importing SSL Client Certificates

The SSL client needs a certificate if **Authenticate Client Certificates** is selected on the ZyWALL.

You must have imported at least one trusted CA to the ZyWALL in order for the **Authenticate Client Certificates** to be active (see the Certificates chapter for details).

Apply for a certificate from a Certification Authority (CA) that is trusted by the ZyWALL (see the ZyWALL's **Trusted CA** web configurator screen).

Figure 447 ZyWALL Trusted CA Screen





CERTIFICATES

My Certificates Trusted CAs Trusted Remote Hosts Directory Servers

PKI Storage Space in Use

0%  100%

Trusted CA Setting

#	Name	Subject	Issuer	Valid From	Valid To	CRL Issuer	Modify
1	CHT-SubCA	OU=SSL CA for Test, O=Chunghwa Telecom Co., Ltd., C=TW	OU=eCA for Test, O=Chunghwa Telecom Co., Ltd., C=TW	2001 Nov 26th, 10:26:35 GMT	2021 Nov 26th, 10:26:35 GMT	No	 
2	SSH-CA	CN=SSH Test CA 1 No Liabilities, O=SSH Communications Security Corp, C=FI	CN=SSH Test CA 1 No Liabilities, O=SSH Communications Security Corp, C=FI	2001 Aug 1st, 07:08:32 GMT	2004 Aug 1st, 07:08:32 GMT	No	 

Import Refresh

The CA sends you a package containing the CA's trusted certificate(s), your personal certificate(s) and a password to install the personal certificate(s).

Installing the CA's Certificate

- 1 Double click the CA's trusted certificate to produce a screen similar to the one shown next.

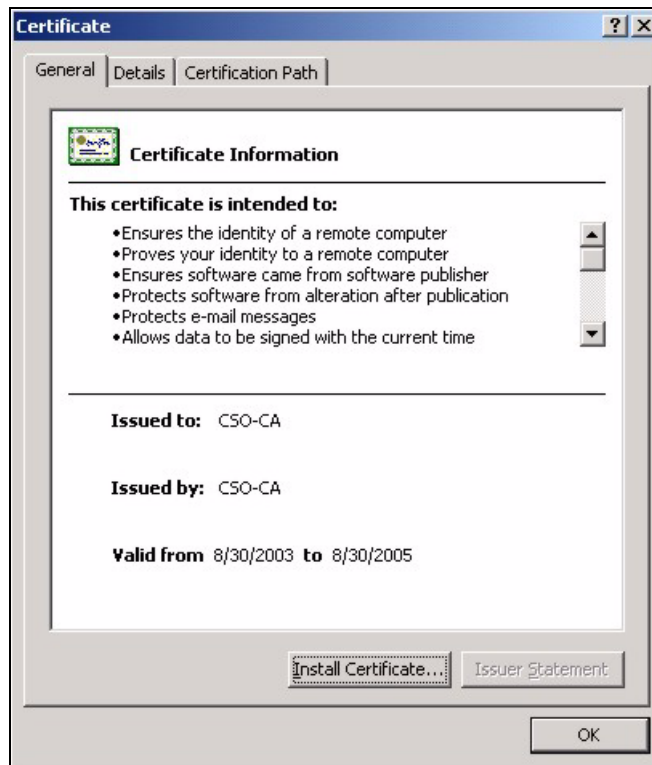
Figure 448 CA Certificate Example

- 2 Click **Install Certificate** and follow the wizard as shown earlier in this appendix.

Installing Your Personal Certificate(s)

You need a password in advance. The CA may issue the password or you may have to specify it during the enrollment. Double-click the personal certificate given to you by the CA to produce a screen similar to the one shown next

- 1 Click **Next** to begin the wizard.

Figure 449 Personal Certificate Import Wizard 1

- 2 The file name and path of the certificate you double-clicked should automatically appear in the **File name** text box. Click **Browse** if you wish to import a different certificate.

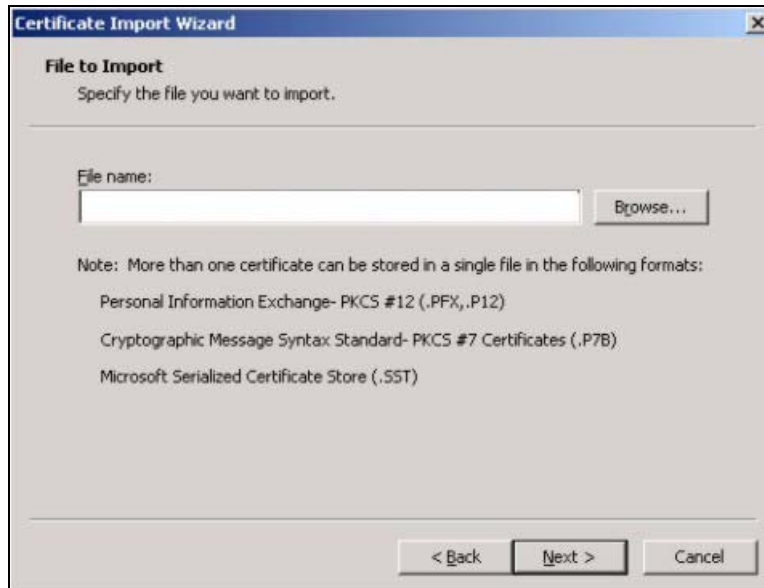
Figure 450 Personal Certificate Import Wizard 2

- 3 Enter the password given to you by the CA.

Figure 451 Personal Certificate Import Wizard 3

- 4 Have the wizard determine where the certificate should be saved on your computer or select **Place all certificates in the following store** and choose a different location.

Figure 452 Personal Certificate Import Wizard 4

- 5 Click **Finish** to complete the wizard and begin the import process.

Figure 453 Personal Certificate Import Wizard 5

- 6 You should see the following screen when the certificate is correctly installed on your computer.

Figure 454 Personal Certificate Import Wizard 6

Using a Certificate When Accessing the ZyWALL Example

Use the following procedure to access the ZyWALL via HTTPS.

- 1 Enter 'https://ZyWALL IP Address/' in your browser's web address field.

Figure 455 Access the ZyWALL Via HTTPS

- 2 When **Authenticate Client Certificates** is selected on the ZyWALL, the following screen asks you to select a personal certificate to send to the ZyWALL. This screen displays even if you only have a single certificate as in the example.

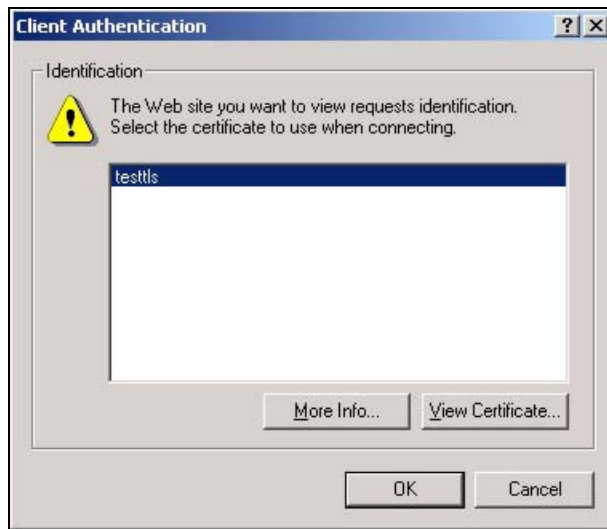
Figure 456 SSL Client Authentication

3 You next see the ZyWALL login screen.

Figure 457 ZyWALL Secure Login Screen

Command Interpreter

The following describes how to use the command interpreter. Enter 24 in the main menu to bring up the system maintenance menu. Enter 8 to go to **Menu 24.8 - Command Interpreter Mode**. See the included disk or zyxel.com for more detailed information on these commands.



Use of undocumented commands or misconfiguration can damage the unit and possibly render it unusable.

Command Syntax

- The command keywords are in `courier new` font.
- Enter the command keywords exactly as shown, do not abbreviate.
- The required fields in a command are enclosed in angle brackets `<>`.
- The optional fields in a command are enclosed in square brackets `[]`.
- The `|` symbol means or.

For example,

```
sys filter netbios config <type> <on|off>
```

means that you must specify the type of netbios filter and whether to turn it on or off.

Command Usage

A list of valid commands can be found by typing `help` or `?` at the command prompt. Always type the full command. Type `exit` to return to the SMT main menu when finished.

Command Examples

This section provides some examples of commands you can use on the ZyWALL. See the other appendices for more examples.

Configuring What You Want the ZyWALL to Log

- 1 Use the `sys logs load` command to load the log setting buffer that allows you to configure which logs the ZyWALL is to record.
- 2 Use `sys logs category` to view a list of the log categories.

Figure 458 Displaying Log Categories Example

```

ras> sys logs category
access          attack          display         error
icmp            ike             ipsec           javablocked
mten            packetfilter   ppp             cdr
pki             tls             remote          tcpreset
traffic         upnp            urlblocked     urlforward

```

- 3 Use `sys logs category` followed by a log category to display the parameters that are available for the category.

Figure 459 Displaying Log Parameters Example

```

ras> sys logs category access
Usage: [0:none/1:log/2:alert/3:both] [0:don't show debug type/
1:show debug type]

```

- 4 Use `sys logs category` followed by a log category and a parameter to decide what to record.
Use 0 to not record logs for that category, 1 to record only logs for that category, 2 to record only alerts for that category, and 3 to record both logs and alerts for that category. Not every parameter is available with every category.
- 5 Use the `sys logs save` command to store the settings in the ZyWALL (you must do this in order to record logs).

Displaying Logs

- Use the `sys logs display` command to show all of the logs in the ZyWALL's log.
- Use the `sys logs category display` command to show the log settings for all of the log categories.
- Use the `sys logs display [log category]` command to show the logs in an individual ZyWALL log category.
- Use the `sys logs clear` command to erase all of the ZyWALL's logs.

Log Command Example

This example shows how to set the ZyWALL to record the access logs and alerts and then view the results.

```

ras> sys logs load
ras> sys logs category access 3
ras> sys logs save
ras> sys logs display access

# .time                source                destination            notes
message
0|06/08/2004 05:58:21 |172.21.4.154          |224.0.1.24            |ACCESS
BLOCK
  Firewall default policy: IGMP (W to W/ZW)
1|06/08/2004 05:58:20 |172.21.3.56           |239.255.255.250       |ACCESS
BLOCK
  Firewall default policy: IGMP (W to W/ZW)
2|06/08/2004 05:58:20 |172.21.0.2            |239.255.255.254       |ACCESS
BLOCK
  Firewall default policy: IGMP (W to W/ZW)
3|06/08/2004 05:58:20 |172.21.3.191          |224.0.1.22            |ACCESS
BLOCK
  Firewall default policy: IGMP (W to W/ZW)
4|06/08/2004 05:58:20 |172.21.0.254          |224.0.0.1              |ACCESS
BLOCK
  Firewall default policy: IGMP (W to W/ZW)
5|06/08/2004 05:58:20 |172.21.4.187:137      |172.21.255.255:137    |ACCESS
BLOCK
  Firewall default policy: UDP (W to W/ZW)

```

Routing Command

Syntax: `ip nat routing [0:LAN|1:DMZ|2:WLAN] [0:no|1:yes]`

Use this command to set the ZyWALL to route traffic that does not match a NAT rule through a specific interface. An example of when you may want to use this is if you have servers with public IP addresses connected to the LAN, DMZ or WLAN. By default the ZyWALL routes traffic that does not match a NAT rule out through the DMZ interface.

The following command example sets the ZyWALL to route traffic that does not match a NAT rule through the WLAN interface.

Figure 460 Routing Command Example

```

ras> ip nat routing 2 1
Routing can work in NAT when no NAT rule match.
-----
LAN: no
DMZ: yes
WLAN: yes

```

ARP Behavior and the ARP ackGratuitous Commands

The ZyWALL does not accept ARP reply information if the ZyWALL did not send out a corresponding request. This helps prevent the ZyWALL from updating its ARP table with an incorrect IP address to MAC address mapping due to a spoofed ARP. An incorrect IP to MAC address mapping in the ZyWALL's ARP table could cause the ZyWALL to send packets to the wrong device.

Commands for Using or Ignoring Gratuitous ARP Requests

A host can send an ARP request to resolve its own IP address. This is called a gratuitous ARP request. The packet uses the host's own IP address as the source and destination IP address. The packet uses the Ethernet broadcast address (FF:FF:FF:FF:FF:FF) as the destination MAC address. This is used to determine if any other hosts on the network are using the same IP address as the sending host. The other hosts in the network can also update their ARP table IP address to MAC address mappings with this host's MAC address.

The `ip arp ackGratuitous` commands set how the ZyWALL handles gratuitous ARP requests.

- Use `ip arp ackGratuitous active no` to have the ZyWALL ignore gratuitous ARP requests.
- Use `ip arp ackGratuitous active yes` to have the ZyWALL respond to gratuitous ARP requests.

For example, say the regular gateway goes down and a backup gateway sends a gratuitous ARP request. If the request is for an IP address that is not already in the ZyWALL's ARP table, the ZyWALL sends an ARP request to ask which host is using the IP address. After the ZyWALL receives a reply from the backup gateway, it adds an ARP table entry.

If the ZyWALL's ARP table already has an entry for the IP address, the ZyWALL's response depends on how you configure the `ip arp ackGratuitous forceUpdate` command.

- Use `ip arp ackGratuitous forceUpdate on` to have the ZyWALL update the MAC address in the ARP entry.
- Use `ip arp ackGratuitous forceUpdate off` to have the ZyWALL not update the MAC address in the ARP entry.

A backup gateway (as in the following graphic) is an example of when you might want to turn on the forced update for gratuitous ARP requests. One day gateway A shuts down and the backup gateway (B) comes online using the same static IP address as gateway A. Gateway B broadcasts a gratuitous ARP request to ask which host is using its IP address. If `ackGratuitous`

is on and set to force updates, the ZyWALL receives the gratuitous ARP request and updates its ARP table. This way the ZyWALL has a correct gateway ARP entry to forward packets through the backup gateway. If `ackGratuitous` is off or not set to force updates, the ZyWALL will not update the gateway ARP entry and cannot forward packets through gateway B.

Figure 461 Backup Gateway

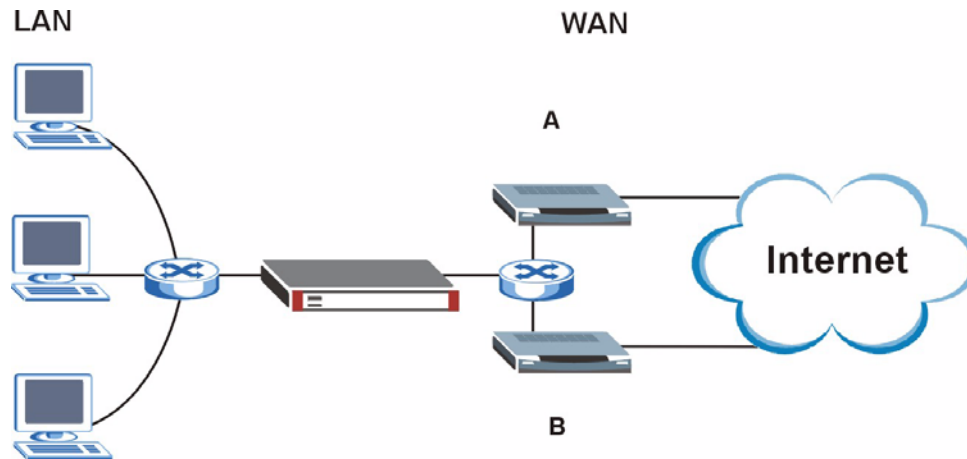

Updating the ARP entries could increase the danger of spoofing attacks. It is only recommended that you turn on `ackGratuitous` and force update if you need it like in the previous backup gateway example. Turning on the force updates option is more dangerous than leaving it off because the ZyWALL updates the ARP table even when there is an existing entry.

Managing the Bandwidth of VPN Traffic

Syntax: `bm vpnTraffic [on|off]`

By default the ZyWALL uses the inner source and destination IP addresses of VPN packets in managing the bandwidth of the VPN traffic. This means that it looks at the IP address of the computer that sent the packets and the IP address of the computer to which it is sending the packets. The following figure shows an example of this. The ZyWALL uses the IP addresses of computers A and B to manage the bandwidth of the VPN traffic for their respective IPsec SA.

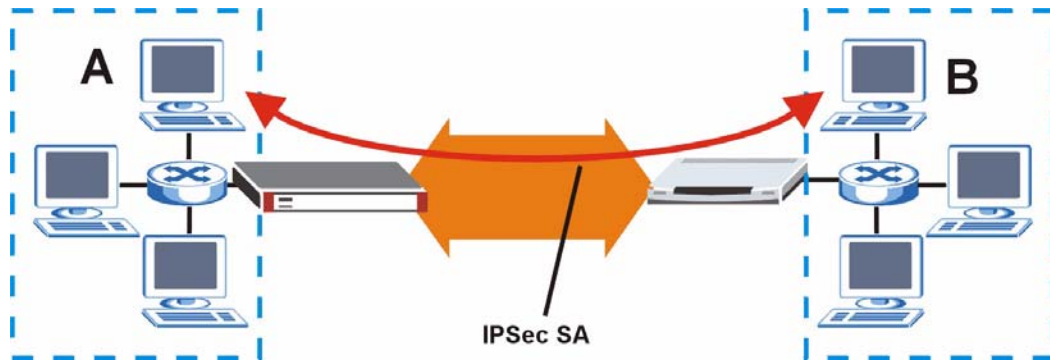
Figure 462 Managing the Bandwidth of an IPsec SA

Use `on` with this command to set the ZyWALL to use the outer source and destination IP addresses of VPN packets in managing the bandwidth of the VPN traffic. These are the IP addresses of the ZyWALL and the remote IPsec router. The following figure shows an example of this. The ZyWALL uses the IP addresses of the ZyWALL (X in the figure) and remote IPsec router (Y) to manage the bandwidth of the VPN traffic for the IKE SA.

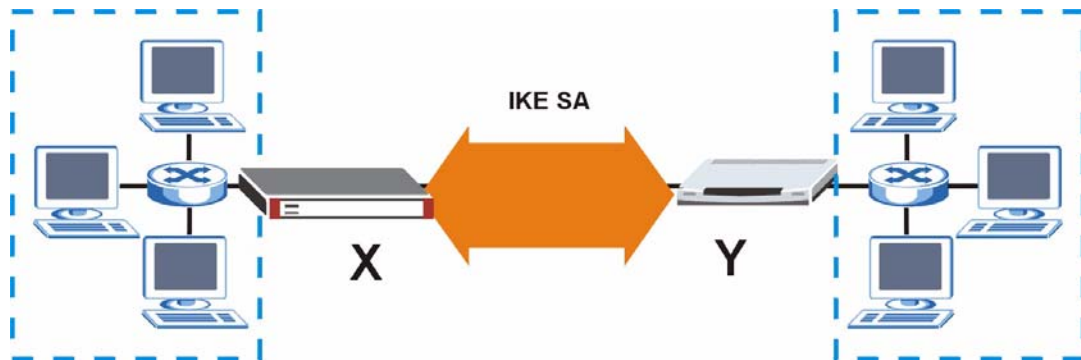
Figure 463 Managing the Bandwidth of an IKE SA

How you configure this command affects how you can implement bandwidth management as follows.

- Leave this command set to `off` to be able to create bandwidth management groups for individual phase 2 IPsec SAs that are connecting through the same remote IPsec router. With this setting you can also specify the type of traffic either using the service list (like SIP or FTP) or by specifying port numbers.
- Use `bm vpnTraffic` to be able to create a single bandwidth management group that includes all of the phase 2 IPsec SAs that are connecting through the same remote IPsec router. With this setting the bandwidth management applies to ESP or AH packets so you can only specify IP addresses. You cannot specify a service or port numbers.

Setting the *Key Length* for Phase 2 IPsec AES Encryption

Syntax: `ipsec ipsecConfig encryKeyLen <0:128 | 1:192 | 2:256>`

By default the ZyWALL uses a 128 bit AES encryption key for phase 2 IPsec tunnels. Use this command to edit an existing VPN rule to use a longer AES encryption key.

See the following example. Say you have a VPN rule one that uses AES for the phase 2 encryption and you want it to use 192 bit encryption.

- Use the first line to start editing the VPN rule.
- The second line sets VPN rule one to use 192 bit AES for the phase 2 encryption.
- The third line displays the results.

Figure 464 Routing Command Example

```
ras> ipsec ipsecEdit 1
ras> ipsec ipsecConfig encryKeyLen 1
ras> ipsec ipsecDisplay
----- IPsec Setup -----
Index #= 1      Active= No      Multi Pro = No      Protocol= 0 Global SW= 0xA
Bound IKE 9999  NailUp = No      Netbios = No      Name= test

ControlPing = No  LogControlPing = No  Control ping address = 0.0.0.0
Local:  Addr Type= SINGLE      Port Start= 0      End= N/A
        IP Addr Start= 0.0.0.0      Mask= N/A
Remote: Addr Type= SINGLE      Port Start= 0      End= N/A
        IP Addr Start= 0.0.0.0      Mask= N/A
Enable Replay Detection= No  Key Management= IKE
Phase 2 - Active Protocol= ESP
        Encryption Algorithm= AES      Authentication Algorithm= SHA1
        Encryption Key Length = 192
        SA Life Time (Seconds)= 28800
        Encapsulation= Tunnel  Perfect Forward Secrecy (PFS)= None
ras>
```

Firewall Commands

The following describes the firewall commands. See [Appendix G on page 631](#) for information on the command structure.

Table 231 Firewall Commands

FUNCTION	COMMAND	DESCRIPTION
Firewall Set-Up		
	<code>config edit firewall active <yes no></code>	This command turns the firewall on or off.
	<code>config retrieve firewall</code>	This command returns the previously saved firewall settings.
	<code>config save firewall</code>	This command saves the current firewall settings.
Display		
	<code>config display firewall</code>	This command shows the of all the firewall settings including e-mail, attack, and the sets/ rules.
	<code>config display firewall set <set #></code>	This command shows the current configuration of a set; including timeout values, name, default-permit, and etc.If you don't put use a number (#) after "set", information about all of the sets/rules appears.
	<code>config display firewall set <set #> rule <rule #></code>	This command shows the current entries of a rule in a firewall rule set.
	<code>config display firewall attack</code>	This command shows all of the attack response settings.
	<code>config display firewall e-mail</code>	This command shows all of the e-mail settings.
	<code>config display firewall ?</code>	This command shows all of the available firewall sub commands.

Table 231 Firewall Commands (continued)

FUNCTION	COMMAND	DESCRIPTION
Edit		
E-mail	<code>config edit firewall e-mail mail-server <ip address of mail server></code>	This command sets the IP address to which the e-mail messages are sent.
	<code>config edit firewall e-mail return-addr <e-mail address></code>	This command sets the source e-mail address of the firewall e-mails.
	<code>config edit firewall e-mail email-to <e-mail address></code>	This command sets the e-mail address to which the firewall e-mails are sent.
	<code>config edit firewall e-mail policy <full hourly daily weekly></code>	This command sets how frequently the firewall log is sent via e-mail.
	<code>config edit firewall e-mail day <sunday monday tuesday wednesday thursday friday saturday></code>	This command sets the day on which the current firewall log is sent through e-mail if the ZyWALL is set to send it on a weekly basis.
	<code>config edit firewall e-mail hour <0-23></code>	This command sets the hour when the firewall log is sent through e-mail if the ZyWALL is set to send it on an hourly, daily or weekly basis.
	<code>config edit firewall e-mail minute <0-59></code>	This command sets the minute of the hour for the firewall log to be sent via e-mail if the ZyWALL is set to send it on a hourly, daily or weekly basis.
Attack	<code>config edit firewall attack send-alert <yes no></code>	This command enables or disables the immediate sending of DOS attack notification e-mail messages.
	<code>config edit firewall attack block <yes no></code>	Set this command to yes to block new traffic after the tcp-max-incomplete threshold is exceeded. Set it to no to delete the oldest half-open session when traffic exceeds the tcp-max-incomplete threshold.
	<code>config edit firewall attack block-minute <0-255></code>	This command sets the number of minutes for new sessions to be blocked when the tcp-max-incomplete threshold is reached. This command is only valid when block is set to yes.

Table 231 Firewall Commands (continued)

FUNCTION	COMMAND	DESCRIPTION
	<code>config edit firewall attack minute-high <0-255></code>	This command sets the threshold rate of new half-open sessions per minute where the ZyWALL starts deleting old half-opened sessions until it gets them down to the minute-low threshold.
	<code>config edit firewall attack minute-low <0-255></code>	This command sets the threshold of half-open sessions where the ZyWALL stops deleting half-opened sessions.
	<code>config edit firewall attack max-incomplete-high <0-255></code>	This command sets the threshold of half-open sessions where the ZyWALL starts deleting old half-opened sessions until it gets them down to the max incomplete low.
	<code>config edit firewall attack max-incomplete-low <0-255></code>	This command sets the threshold where the ZyWALL stops deleting half-opened sessions.
	<code>config edit firewall attack tcp-max-incomplete <0-255></code>	This command sets the threshold of half-open TCP sessions with the same destination where the ZyWALL starts dropping half-open sessions to that destination.
Sets	<code>config edit firewall set <set #> name <desired name></code>	This command sets a name to identify a specified set.
	<code>Config edit firewall set <set #> default-permit <forward block></code>	This command sets whether a packet is dropped or allowed through, when it does not meet a rule within the set.
	<code>Config edit firewall set <set #> icmp-timeout <seconds></code>	This command sets the time period to allow an ICMP session to wait for the ICMP response.
	<code>Config edit firewall set <set #> udp-idle-timeout <seconds></code>	This command sets how long a UDP connection is allowed to remain inactive before the ZyWALL considers the connection closed.
	<code>Config edit firewall set <set #> connection-timeout <seconds></code>	This command sets how long ZyWALL waits for a TCP session to be established before dropping the session.
	<code>Config edit firewall set <set #> fin-wait-timeout <seconds></code>	This command sets how long the ZyWALL leaves a TCP session open after the firewall detects a FIN-exchange (indicating the end of the TCP session).

Table 231 Firewall Commands (continued)

FUNCTION	COMMAND	DESCRIPTION
	Config edit firewall set <set #> tcp-idle-timeout <seconds>	This command sets how long ZyWALL lets an inactive TCP connection remain open before considering it closed.
	Config edit firewall set <set #> log <yes no>	This command sets whether or not the ZyWALL creates logs for packets that match the firewall's default rule set.
Rules	Config edit firewall set <set #> rule <rule #> permit <forward block>	This command sets whether packets that match this rule are dropped or allowed through.
	Config edit firewall set <set #> rule <rule #> active <yes no>	This command sets whether a rule is enabled or not.
	Config edit firewall set <set #> rule <rule #> protocol <integer protocol value >	This command sets the protocol specification number made in this rule for ICMP.
	Config edit firewall set <set #> rule <rule #> log <none match not-match both>	This command sets the ZyWALL to log traffic that matches the rule, doesn't match, both or neither.
	Config edit firewall set <set #> rule <rule #> alert <yes no>	This command sets whether or not the ZyWALL sends an alert e-mail when a DOS attack or a violation of a particular rule occurs.
	config edit firewall set <set #> rule <rule #> srcaddr-single <ip address>	This command sets the rule to have the ZyWALL check for traffic with this individual source address.
	config edit firewall set <set #> rule <rule #> srcaddr-subnet <ip address> <subnet mask>	This command sets a rule to have the ZyWALL check for traffic from a particular subnet (defined by IP address and subnet mask).
	config edit firewall set <set #> rule <rule #> srcaddr-range <start ip address> <end ip address>	This command sets a rule to have the ZyWALL check for traffic from this range of addresses.
	config edit firewall set <set #> rule <rule #> destaddr-single <ip address>	This command sets the rule to have the ZyWALL check for traffic with this individual destination address.

Table 231 Firewall Commands (continued)

FUNCTION	COMMAND	DESCRIPTION
	<code>config edit firewall set <set #> rule <rule #> destaddr-subnet <ip address> <subnet mask></code>	This command sets a rule to have the ZyWALL check for traffic with a particular subnet destination (defined by IP address and subnet mask).
	<code>config edit firewall set <set #> rule <rule #> destaddr-range <start ip address> <end ip address></code>	This command sets a rule to have the ZyWALL check for traffic going to this range of addresses.
	<code>config edit firewall set <set #> rule <rule #> TCP destport-single <port #></code>	This command sets a rule to have the ZyWALL check for TCP traffic with this destination address. You may repeat this command to enter various, non-consecutive port numbers.
	<code>config edit firewall set <set #> rule <rule #> TCP destport-range <start port #> <end port #></code>	This command sets a rule to have the ZyWALL check for TCP traffic with a destination port in this range.
	<code>config edit firewall set <set #> rule <rule #> UDP destport-single <port #></code>	This command sets a rule to have the ZyWALL check for UDP traffic with this destination address. You may repeat this command to enter various, non-consecutive port numbers.
	<code>config edit firewall set <set #> rule <rule #> UDP destport-range <start port #> <end port #></code>	This command sets a rule to have the ZyWALL check for UDP traffic with a destination port in this range.
Delete		
	<code>config delete firewall e-mail</code>	This command removes all of the settings for e-mail alert.
	<code>config delete firewall attack</code>	This command resets all of the attack response settings to their defaults.
	<code>config delete firewall set <set #></code>	This command removes the specified set from the firewall configuration.
	<code>config delete firewall set <set #> rule<rule #></code>	This command removes the specified rule in a firewall configuration set.

NetBIOS Filter Commands

The following describes the NetBIOS packet filter commands. See [Appendix G on page 631](#) for information on the command structure.

Introduction

NetBIOS (Network Basic Input/Output System) are TCP or UDP broadcast packets that enable a computer to connect to and communicate with a LAN.

For some dial-up services such as PPPoE or PPTP, NetBIOS packets cause unwanted calls.

You can configure NetBIOS filters to do the following:

- Allow or disallow the sending of NetBIOS packets from the LAN to the WAN and from the WAN to the LAN.
- Allow or disallow the sending of NetBIOS packets from the LAN to the DMZ and from the DMZ to the LAN.
- Allow or disallow the sending of NetBIOS packets from the WAN to the DMZ and from the DMZ to the WAN.
- Allow or disallow the sending of NetBIOS packets through VPN connections.
- Allow or disallow NetBIOS packets to initiate calls.

Display NetBIOS Filter Settings

Syntax: `sys filter netbios disp`

This command gives a read-only list of the current NetBIOS filter modes for The ZyWALL.

NetBIOS Display Filter Settings Command Example

```
===== NetBIOS Filter Status =====  
Between LAN and WAN: Block  
Between LAN and DMZ: Block  
Between WAN and DMZ: Block  
IPSec Packets: Forward  
Trigger Dial: Disabled
```

The filter types and their default settings are as follows.

Table 232 NetBIOS Filter Default Settings

NAME	DESCRIPTION	EXAMPLE
Between LAN and WAN	This field displays whether NetBIOS packets are blocked or forwarded between the LAN and the WAN.	Block
Between LAN and DMZ	This field displays whether NetBIOS packets are blocked or forwarded between the LAN and the DMZ.	Block
Between WAN and DMZ	This field displays whether NetBIOS packets are blocked or forwarded between the WAN and the DMZ.	Block
IPSec Packets	This field displays whether NetBIOS packets sent through a VPN connection are blocked or forwarded.	Forward
Trigger dial	This field displays whether NetBIOS packets are allowed to initiate calls. Disabled means that NetBIOS packets are blocked from initiating calls.	Disabled

NetBIOS Filter Configuration

Syntax: `sys filter netbios config <type> <on|off>`

where

`<type>` = Identify which NetBIOS filter (numbered 0-3) to configure.

0 = Between LAN and WAN

1 = Between LAN and DMZ

2 = Between WAN and DMZ

3 = IPSec packet pass through

4 = Trigger Dial

`<on|off>` = For type 0 and 1, use on to enable the filter and block NetBIOS packets. Use off to disable the filter and forward NetBIOS packets. For type 3, use on to block NetBIOS packets from being sent through a VPN connection. Use off to allow NetBIOS packets to be sent through a VPN connection.

For type 4, use on to allow NetBIOS packets to initiate dial backup calls. Use off to block NetBIOS packets from initiating dial backup calls.

Example commands

`sys filter netbios config 0 on` This command blocks LAN to WAN and WAN to LAN NetBIOS packets.

`sys filter netbios config 1 off` This command forwards LAN to DMZ and DMZ to LAN NetBIOS packets.

`sys filter netbios config 3 on` This command blocks IPSec NetBIOS packets.

`sys filter netbios config 4 off` This command stops NetBIOS commands from initiating calls.

Certificates Commands

The following describes the certificate commands. See [Appendix G on page 631](#) for information on the command structure.

All of these commands start with certificates.

Table 233 Certificates Commands

COMMAND	DESCRIPTION		
my_cert			
	create		
	create	selfsigned <name> <subject> [key size]	Create a self-signed local host certificate. <name> specifies a descriptive name for the generated certificate. <subject> specifies a subject name (required) and alternative name (required). The format is "subject-name-dn;{ip,dns,email}=value". If the name contains spaces, please put it in quotes. [key size] specifies the key size. It has to be an integer from 512 to 2048. The default is 1024 bits.
	create	request <name> <subject> [key size]	Create a certificate request and save it to the router for later manual enrollment. <name> specifies a descriptive name for the generated certification request. <subject> specifies a subject name (required) and alternative name (required). The format is "subject-name-dn;{ip,dns,email}=value". If the name contains spaces, please put it in quotes. [key size] specifies the key size. It has to be an integer from 512 to 2048. The default is 1024 bits.
	create	scep_enroll <name> <CA addr> <CA cert> <auth key> <subject> [key size]	Create a certificate request and enroll for a certificate immediately online using SCEP protocol. <name> specifies a descriptive name for the enrolled certificate. <CA addr> specifies the CA server address. <CA cert> specifies the name of the CA certificate. <auth key> specifies the key used for user authentication. If the key contains spaces, please put it in quotes. To leave it blank, type "". <subject> specifies a subject name (required) and alternative name (required). The format is "subject-name-dn;{ip,dns,email}=value". If the name contains spaces, please put it in quotes. [key size] specifies the key size. It has to be an integer from 512 to 2048. The default is 1024 bits.

Table 233 Certificates Commands (continued)

COMMAND	DESCRIPTION		
	create	<p>cmp_enroll <name> <CA addr> <CA cert> <auth key> <subject> [key size]</p>	<p>Create a certificate request and enroll for a certificate immediately online using CMP protocol. <name> specifies a descriptive name for the enrolled certificate. <CA addr> specifies the CA server address. <CA cert> specifies the name of the CA certificate. <auth key> specifies the id and key used for user authentication. The format is "id:key". To leave the id and key blank, type ":". <subject> specifies a subject name (required) and alternative name (required). The format is "subject-name-dn;{ip,dns,email}=value". If the name contains spaces, please put it in quotes. [key size] specifies the key size. It has to be an integer from 512 to 2048. The default is 1024 bits.</p>
	import	[name]	<p>Import the PEM-encoded certificate from stdin. [name] specifies the descriptive name (optional) as which the imported certificate is to be saved. For my certificate importation to be successful, a certification request corresponding to the imported certificate must already exist on ZyWALL. After the importation, the certification request will automatically be deleted. If a descriptive name is not specified for the imported certificate, the certificate will adopt the descriptive name of the certification request.</p>
	export	<name>	<p>Export the PEM-encoded certificate to stdout for user to copy and paste. <name> specifies the name of the certificate to be exported.</p>
	view	<name>	<p>View the information of the specified local host certificate. <name> specifies the name of the certificate to be viewed.</p>
	verify	<name> [timeout]	<p>Verify the certification path of the specified local host certificate. <name> specifies the name of the certificate to be verified. [timeout] specifies the timeout value in seconds (optional). The default timeout value is 20 seconds.</p>
	delete	<name>	<p>Delete the specified local host certificate. <name> specifies the name of the certificate to be deleted.</p>
	list		<p>List all my certificate names and basic information.</p>
	rename	<old name> <new name>	<p>Rename the specified my certificate. <old name> specifies the name of the certificate to be renamed. <new name> specifies the new name as which the certificate is to be saved.</p>
	def_self_signed	[name]	<p>Set the specified self-signed certificate as the default self-signed certificate. [name] specifies the name of the certificate to be set as the default self-signed certificate. If [name] is not specified, the name of the current self-signed certificate is displayed.</p>
	replace_factory		<p>Create a certificate using your device MAC address that will be specific to this device. The factory default certificate is a common default certificate for all ZyWALL models.</p>

Table 233 Certificates Commands (continued)

COMMAND	DESCRIPTION		
ca_trusted			
	import	<name>	Import the PEM-encoded certificate from stdin. <name> specifies the name as which the imported CA certificate is to be saved.
	export	<name>	Export the PEM-encoded certificate to stdout for user to copy and paste. <name> specifies the name of the certificate to be exported.
	view	<name>	View the information of the specified trusted CA certificate. <name> specifies the name of the certificate to be viewed.
	verify	<name> [timeout]	Verify the certification path of the specified trusted CA certificate. <name> specifies the name of the certificate to be verified. [timeout] specifies the timeout value in seconds (optional). The default timeout value is 20 seconds.
	delete	<name>	Delete the specified trusted CA certificate. <name> specifies the name of the certificate to be deleted.
	list		List all trusted CA certificate names and basic information.
	rename	<old name> <new name>	Rename the specified trusted CA certificate. <old name> specifies the name of the certificate to be renamed. <new name> specifies the new name as which the certificate is to be saved.
	crl_issuer	<name> [on off]	Specify whether or not the specified CA issues CRL. <name> specifies the name of the CA certificate. [on off] specifies whether or not the CA issues CRL. If [on off] is not specified, the current crl_issuer status of the CA.
remote_trusted			
	import	<name>	Import the PEM-encoded certificate from stdin. <name> specifies the name as which the imported remote host certificate is to be saved.
	export	<name>	Export the PEM-encoded certificate to stdout for user to copy and paste. <name> specifies the name of the certificate to be exported.
	view	<name>	View the information of the specified trusted remote host certificate. <name> specifies the name of the certificate to be viewed.
	verify	<name> [timeout]	Verify the certification path of the specified trusted remote host certificate. <name> specifies the name of the certificate to be verified. [timeout] specifies the timeout value in seconds (optional). The default timeout value is 20 seconds.
	delete	<name>	Delete the specified trusted remote host certificate. <name> specifies the name of the certificate to be deleted.
	list		List all trusted remote host certificate names and basic information.

Table 233 Certificates Commands (continued)

COMMAND	DESCRIPTION		
	rename	<old name> <new name>	Rename the specified trusted remote host certificate. <old name> specifies the name of the certificate to be renamed. <new name> specifies the new name as which the certificate is to be saved.
dir_server			
	add	<name> <addr[:port]> [login:pswd]	Add a new directory service. <name> specifies a descriptive name as which the added directory server is to be saved. <addr[:port]> specifies the server address (required) and port (optional). The format is "server-address[:port]". The default port is 389. [login:pswd] specifies the login name and password, if required. The format is "[login:password]".
	delete	<name>	Delete the specified directory service. <name> specifies the name of the directory server to be deleted.
	view	<name>	View the specified directory service. <name> specifies the name of the directory server to be viewed.
	edit	<name> <addr[:port]> [login:pswd]	Edit the specified directory service. <name> specifies the name of the directory server to be edited. <addr[:port]> specifies the server address (required) and port (optional). The format is "server-address[:port]". The default port is 389. [login:pswd] specifies the login name and password, if required. The format is "[login:password]".
	list		List all directory service names and basic information.
	rename	<old name> <new name>	Rename the specified directory service. <old name> specifies the name of the directory server to be renamed. <new name> specifies the new name as which the directory server is to be saved.
cert_manager			
	reinit		Reinitialize the certificate manager.

Brute-Force Password Guessing Protection

Brute-force password guessing protection allows you to specify a wait-time that must expire before entering a fourth password after three incorrect passwords have been entered.

The following describes the commands for enabling, disabling and configuring the brute-force password guessing protection mechanism for the password. See [Appendix G on page 631](#) for information on the command structure.

Table 234 Brute-Force Password Guessing Protection Commands

COMMAND	DESCRIPTION
sys pwderrtm	This command displays the brute-force guessing password protection settings.
sys pwderrtm 0	This command turns off the password's protection from brute-force guessing. The brute-force password guessing protection is turned off by default.
sys pwderrtm N	This command sets the password protection to block all access attempts for N (a number from 1 to 60) minutes after the third time an incorrect password is entered.

Example

```
sys pwderrtm 5
```

This command sets the password protection to block all access attempts for five minutes after the third time an incorrect password is entered.

Boot Commands

The BootModule AT commands execute from within the router's bootup software, when debug mode is selected before the main router firmware is started. When you start up your ZyWALL, you are given a choice to go into debug mode by pressing a key at the prompt shown in the following screen. In debug mode you have access to a series of boot module commands, for example ATUR (for uploading firmware) and ATLC (for uploading the configuration file). These are already discussed in the **Firmware and Configuration File Maintenance** chapter.

Figure 465 Option to Enter Debug Mode

```
Bootbase Version: V1.02 | 08/08/2001 15:40:50
RAM: Size = 16384 Kbytes
DRAM Post: Testing: 16384K OK
FLASH: Intel 16M
RAS Version: V4.01(XU.0)b1 | 08/08/2006 16:21:27
Press any key to enter debug mode within 3
seconds.
.....
```

Enter ATHE to view all available ZyWALL boot module commands as shown in the next screen. ATBAx allows you to change the console port speed. The x denotes the number preceding the colon to give the console port speed following the colon in the list of numbers that follows; for example ATBA3 will give a console port speed of 9.6 Kbps. ATSE displays the seed that is used to generate a password to turn on the debug flag in the firmware. The ATSH command shows product related information such as boot module version, vendor name, product model, RAS code revision, etc. ATGO allows you to continue booting the system. Most other commands aid in advanced troubleshooting and should only be used by qualified engineers.

Figure 466 Boot Module Commands

AT	just answer OK
ATHE	print help
ATBAx	change baudrate. 1:38.4k, 2:19.2k, 3:9.6k 4:57.6k 5:115.2k
ATENx,(y)	set BootExtension Debug Flag (y=password)
ATSE	show the seed of password generator
ATTI(h,m,s)	change system time to hour:min:sec or show current time
ATDA(y,m,d)	change system date to year/month/day or show current date
ATDS	dump RAS stack
ATDT	dump Boot Module Common Area
ATDUx,y	dump memory contents from address x for length y
ATRBx	display the 8-bit value of address x
ATRWx	display the 16-bit value of address x
ATRLx	display the 32-bit value of address x
ATGO(x)	run program at addr x or boot router
ATGR	boot router
ATGT	run Hardware Test Program
ATRTw,x,y(,z)	RAM test level w, from address x to y (z iterations)
ATSH	dump manufacturer related data in ROM
ATDOx,y	download from address x for length y to PC via XMODEM
ATTD	download router configuration to PC via XMODEM
ATUR	upload router firmware to flash ROM
ATLC	upload router configuration file to flash ROM
ATXSx	xmodem select: x=0: CRC mode(default); x=1: checksum mode
ATSR	system reboot

Legal Information

Copyright

Copyright © 2006 by ZyXEL Communications Corporation.

The contents of this publication may not be reproduced in any part or as a whole, transcribed, stored in a retrieval system, translated into any language, or transmitted in any form or by any means, electronic, mechanical, magnetic, optical, chemical, photocopying, manual, or otherwise, without the prior written permission of ZyXEL Communications Corporation.

Published by ZyXEL Communications Corporation. All rights reserved.

Disclaimer

ZyXEL does not assume any liability arising out of the application or use of any products, or software described herein. Neither does it convey any license under its patent rights nor the patent rights of others. ZyXEL further reserves the right to make changes in any products described herein without notice. This publication is subject to change without notice.

Trademarks

ZyNOS (ZyXEL Network Operating System) is a registered trademark of ZyXEL Communications, Inc. Other trademarks mentioned in this publication are used for identification purposes only and may be properties of their respective owners.

Certifications

Federal Communications Commission (FCC) Interference Statement

The device complies with Part 15 of FCC rules. Operation is subject to the following two conditions:

- This device may not cause harmful interference.
- This device must accept any interference received, including interference that may cause undesired operations.

This device has been tested and found to comply with the limits for a Class B digital device pursuant to Part 15 of the FCC Rules. These limits are designed to provide reasonable protection against harmful interference in a residential installation. This device generates, uses, and can radiate radio frequency energy, and if not installed and used in accordance with the instructions, may cause harmful interference to radio communications. However, there is no guarantee that interference will not occur in a particular installation.

If this device does cause harmful interference to radio/television reception, which can be determined by turning the device off and on, the user is encouraged to try to correct the interference by one or more of the following measures:

- 1 Reorient or relocate the receiving antenna.
- 2 Increase the separation between the equipment and the receiver.
- 3 Connect the equipment into an outlet on a circuit different from that to which the receiver is connected.
- 4 Consult the dealer or an experienced radio/TV technician for help.

Notices

Changes or modifications not expressly approved by the party responsible for compliance could void the user's authority to operate the equipment.

This Class B digital apparatus complies with Canadian ICES-003.

Cet appareil numérique de la classe B est conforme à la norme NMB-003 du Canada.

Viewing Certifications

- 1 Go to <http://www.zyxel.com>.
- 2 Select your product on the ZyXEL home page to go to that product's page.
- 3 Select the certification you wish to view from this page.

ZyXEL Limited Warranty

ZyXEL warrants to the original end user (purchaser) that this product is free from any defects in materials or workmanship for a period of up to two years from the date of purchase. During the warranty period, and upon proof of purchase, should the product have indications of failure due to faulty workmanship and/or materials, ZyXEL will, at its discretion, repair or replace the defective products or components without charge for either parts or labor, and to whatever extent it shall deem necessary to restore the product or components to proper operating condition. Any replacement will consist of a new or re-manufactured functionally equivalent product of equal or higher value, and will be solely at the discretion of ZyXEL. This warranty shall not apply if the product has been modified, misused, tampered with, damaged by an act of God, or subjected to abnormal working conditions.

Note

Repair or replacement, as provided under this warranty, is the exclusive remedy of the purchaser. This warranty is in lieu of all other warranties, express or implied, including any implied warranty of merchantability or fitness for a particular use or purpose. ZyXEL shall in no event be held liable for indirect or consequential damages of any kind to the purchaser.

To obtain the services of this warranty, contact ZyXEL's Service Center for your Return Material Authorization number (RMA). Products must be returned Postage Prepaid. It is recommended that the unit be insured when shipped. Any returned products without proof of purchase or those with an out-dated warranty will be repaired or replaced (at the discretion of

ZyXEL) and the customer will be billed for parts and labor. All repaired or replaced products will be shipped by ZyXEL to the corresponding return address, Postage Paid. This warranty gives you specific legal rights, and you may also have other rights that vary from country to country.

Registration

Register your product online to receive e-mail notices of firmware upgrades and information at www.zyxel.com for global products, or at www.us.zyxel.com for North American products.

Customer Support

Please have the following information ready when you contact customer support.

Required Information

- Product model and serial number.
- Warranty Information.
- Date that you received your device.
- Brief description of the problem and the steps you took to solve it.

Corporate Headquarters (Worldwide)

- Support E-mail: support@zyxel.com.tw
- Sales E-mail: sales@zyxel.com.tw
- Telephone: +886-3-578-3942
- Fax: +886-3-578-2439
- Web Site: www.zyxel.com, www.europe.zyxel.com
- FTP Site: [ftp.zyxel.com](ftp://ftp.zyxel.com), [ftp.europe.zyxel.com](ftp://ftp.europe.zyxel.com)
- Regular Mail: ZyXEL Communications Corp., 6 Innovation Road II, Science Park, Hsinchu 300, Taiwan

Costa Rica

- Support E-mail: soporte@zyxel.co.cr
- Sales E-mail: sales@zyxel.co.cr
- Telephone: +506-2017878
- Fax: +506-2015098
- Web Site: www.zyxel.co.cr
- FTP Site: [ftp.zyxel.co.cr](ftp://ftp.zyxel.co.cr)
- Regular Mail: ZyXEL Costa Rica, Plaza Roble Escazú, Etapa El Patio, Tercer Piso, San José, Costa Rica

Czech Republic

- E-mail: info@cz.zyxel.com
- Telephone: +420-241-091-350
- Fax: +420-241-091-359
- Web Site: www.zyxel.cz
- Regular Mail: ZyXEL Communications, Czech s.r.o., Modranská 621, 143 01 Praha 4 - Modrany, Česká Republika

Denmark

- Support E-mail: support@zyxel.dk
- Sales E-mail: sales@zyxel.dk
- Telephone: +45-39-55-07-00
- Fax: +45-39-55-07-07
- Web Site: www.zyxel.dk
- Regular Mail: ZyXEL Communications A/S, Columbusvej, 2860 Soeborg, Denmark

Finland

- Support E-mail: support@zyxel.fi
- Sales E-mail: sales@zyxel.fi
- Telephone: +358-9-4780-8411
- Fax: +358-9-4780 8448
- Web Site: www.zyxel.fi
- Regular Mail: ZyXEL Communications Oy, Malminkaari 10, 00700 Helsinki, Finland

France

- E-mail: info@zyxel.fr
- Telephone: +33-4-72-52-97-97
- Fax: +33-4-72-52-19-20
- Web Site: www.zyxel.fr
- Regular Mail: ZyXEL France, 1 rue des Vergers, Bat. 1 / C, 69760 Limonest, France

Germany

- Support E-mail: support@zyxel.de
- Sales E-mail: sales@zyxel.de
- Telephone: +49-2405-6909-0
- Fax: +49-2405-6909-99
- Web Site: www.zyxel.de
- Regular Mail: ZyXEL Deutschland GmbH., Adenauerstr. 20/A2 D-52146, Wuerselen, Germany

Hungary

- Support E-mail: support@zyxel.hu
- Sales E-mail: info@zyxel.hu
- Telephone: +36-1-3361649
- Fax: +36-1-3259100
- Web Site: www.zyxel.hu
- Regular Mail: ZyXEL Hungary, 48, Zoldlomb Str., H-1025, Budapest, Hungary

Kazakhstan

- Support: <http://zyxel.kz/support>
- Sales E-mail: sales@zyxel.kz

- Telephone: +7-3272-590-698
- Fax: +7-3272-590-689
- Web Site: www.zyxel.kz
- Regular Mail: ZyXEL Kazakhstan, 43, Dostyk ave., Office 414, Dostyk Business Centre, 050010, Almaty, Republic of Kazakhstan

North America

- Support E-mail: support@zyxel.com
- Sales E-mail: sales@zyxel.com
- Telephone: +1-800-255-4101, +1-714-632-0882
- Fax: +1-714-632-0858
- Web Site: www.us.zyxel.com
- FTP Site: <ftp.us.zyxel.com>
- Regular Mail: ZyXEL Communications Inc., 1130 N. Miller St., Anaheim, CA 92806-2001, U.S.A.

Norway

- Support E-mail: support@zyxel.no
- Sales E-mail: sales@zyxel.no
- Telephone: +47-22-80-61-80
- Fax: +47-22-80-61-81
- Web Site: www.zyxel.no
- Regular Mail: ZyXEL Communications A/S, Nils Hansens vei 13, 0667 Oslo, Norway

Poland

- E-mail: info@pl.zyxel.com
- Telephone: +48 (22) 333 8250
- Fax: +48 (22) 333 8251
- Web Site: www.pl.zyxel.com
- Regular Mail: ZyXEL Communications, ul. Okrzei 1A, 03-715 Warszawa, Poland

Russia

- Support: <http://zyxel.ru/support>
- Sales E-mail: sales@zyxel.ru
- Telephone: +7-095-542-89-29
- Fax: +7-095-542-89-25
- Web Site: www.zyxel.ru
- Regular Mail: ZyXEL Russia, Ostrovityanova 37a Str., Moscow, 117279, Russia

Spain

- Support E-mail: support@zyxel.es
- Sales E-mail: sales@zyxel.es
- Telephone: +34-902-195-420
- Fax: +34-913-005-345

- Web Site: www.zyxel.es
- Regular Mail: ZyXEL Communications, Arte, 21 5ª planta, 28033 Madrid, Spain

Sweden

- Support E-mail: support@zyxel.se
- Sales E-mail: sales@zyxel.se
- Telephone: +46-31-744-7700
- Fax: +46-31-744-7701
- Web Site: www.zyxel.se
- Regular Mail: ZyXEL Communications A/S, Sjöporten 4, 41764 Göteborg, Sweden

Ukraine

- Support E-mail: support@ua.zyxel.com
- Sales E-mail: sales@ua.zyxel.com
- Telephone: +380-44-247-69-78
- Fax: +380-44-494-49-32
- Web Site: www.ua.zyxel.com
- Regular Mail: ZyXEL Ukraine, 13, Pimonenko Str., Kiev, 04050, Ukraine

United Kingdom

- Support E-mail: support@zyxel.co.uk
- Sales E-mail: sales@zyxel.co.uk
- Telephone: +44-1344 303044, 08707 555779 (UK only)
- Fax: +44-1344 303034
- Web Site: www.zyxel.co.uk
- FTP Site: [ftp.zyxel.co.uk](ftp://ftp.zyxel.co.uk)
- Regular Mail: ZyXEL Communications UK, Ltd., 11 The Courtyard, Eastern Road, Bracknell, Berkshire, RG12 2XB, United Kingdom (UK)

“+” is the (prefix) number you dial to make an international telephone call.

Index

Numerics

9600 baud [441](#)

A

active protocol [251](#)

AH [251](#)

and encapsulation [252](#)

ESP [251](#)

Address Assignment [339](#)

address assignment [143](#)

AH [251](#)

and transport mode [252](#)

ALG [383](#)

RTP [384](#)

SIP [385](#)

STUN [385](#)

allocated budget [460](#), [485](#)

alternative subnet mask notation [609](#)

anti-probing [199](#)

Application Layer Gateway. See ALG.

Applications [45](#)

broadband connection [45](#)

applications [45](#)

asymmetrical routes [190](#)

vs virtual interfaces [190](#)

AT command [457](#), [544](#)

authentication [484](#)

authentication algorithms [237](#), [243](#)

and active protocol [237](#)

Authentication Header. See AH.

authentication protocol [460](#), [484](#)

B

backup configuration [436](#), [544](#)

TFTP [547](#)

bandwidth class [325](#)

bandwidth filter [325](#)

bandwidth management [325](#)

bandwidth borrowing [329](#)

bandwidth class [325](#)

bandwidth filter [325](#), [334](#)

class configuration [333](#)

class setup [332](#)

fairness-based scheduler [327](#)

maximize bandwidth usage [327](#), [332](#)

monitor [337](#)

priority-based scheduler [327](#)

proportional allocation [326](#)

root class [332](#)

scheduler [327](#), [332](#)

statistics [336](#)

sub-class layers [332](#)

baud [441](#)

BPDU [136](#)

bridge firewall [55](#), [137](#), [430](#), [432](#)

Bridge Protocol Data Unit. See BPDU.

broadcast [125](#)

budget [485](#)

budget management [559](#)

C

CA [273](#)

call back delay [459](#)

call control [559](#)

call history [560](#)

call scheduling [569](#)

max number of schedule sets [569](#)

PPPoE [571](#)

precedence [569](#)

setting up a schedule [570](#)

call-triggering packet [538](#)

certificate [246](#)

certificates [273](#)

and IKE SA [239](#)

CA [273](#)

thumbprint algorithms [274](#)

thumbprints [274](#)

verifying fingerprints [274](#)

Certification Authority. See CA.

certifications [655](#)

notices [656](#)

viewing [656](#)

changing the password [446](#)

CHAP [460](#), [485](#)

- CNM [370](#)
- command interpreter mode [557](#)
- command line [545](#)
- commands
 - FTP [545](#)
- computer names [126](#), [128](#)
- configuration backup [436](#), [544](#)
 - TFTP [547](#)
- configuration restore [436](#), [549](#)
 - via console port [555](#)
- connection ID/name [486](#)
- console port [441](#), [533](#)
 - configuration upload [555](#)
 - data bits [441](#)
 - file backup [548](#)
 - file upload [554](#)
 - flow control [441](#)
 - parity [441](#)
 - restoring files [550](#)
 - settings [441](#)
 - speed [533](#), [534](#)
 - stop bit [441](#)
- contact information [659](#)
- content filter general [209](#)
- content filtering [209](#)
 - categories [209](#), [212](#)
 - customizing [219](#)
 - days and times [209](#)
 - filter list [209](#)
 - restrict web features [209](#)
 - URL for blocked access [211](#)
- copyright [655](#)
- custom ports [204](#)
- customer support [659](#)

D

- data bits [441](#)
- Data Terminal Ready. See DTR
- date setting [425](#), [561](#)
- daylight saving [427](#), [562](#)
- Daytime time protocol [427](#)
- DDNS
 - configuration [450](#), [451](#)
 - host [453](#)
 - offline [453](#)
 - type [453](#)
 - use server detected IP [453](#)
 - wildcard [453](#)
- default configuration [51](#)
- default server IP address [315](#)
- default settings [437](#)

- Denial of Service. See DoS.
- device introduction [45](#)
- DHCP [63](#), [125](#), [126](#), [347](#), [469](#)
 - Relay [469](#)
 - Server [469](#)
 - WAN [540](#)
- DHCP clients [424](#)
- DHCP table [63](#)
- diagnostic [539](#)
- dial timeout [459](#)
- Diffie-Hellman key group [238](#)
 - Perfect Forward Secrecy (PFS) [252](#)
- Dimensions [581](#)
- disclaimer [655](#)
- DMZ
 - IP alias setup [479](#)
 - port filter setup [477](#)
 - setup [477](#)
 - TCP/IP setup [478](#)
- DNS [369](#)
- DNS Server
 - For VPN Host [340](#)
- DNS server address assignment [143](#)
- domain name [423](#), [534](#)
- Domain Name System. See DNS.
- DoS [181](#), [202](#)
- drop timeout [459](#)
- DSL modem [483](#)
- DTR [159](#), [458](#)
- Dynamic DNS [347](#), [348](#)
- Dynamic Host Configuration Protocol. See DHCP.
- DYNDNS Wildcard [340](#), [348](#)

E

- Encapsulating Security Payload. See ESP.
- encapsulation [474](#), [482](#), [486](#)
 - and active protocol [252](#)
 - transport mode [251](#)
 - tunnel mode [251](#)
 - VPN [251](#)
- encryption algorithms [237](#), [243](#)
 - and active protocol [237](#)
- entering information [443](#)
- ESP [251](#)
 - and transport mode [252](#)
- Ethernet
 - encapsulation [68](#), [473](#), [482](#)
- extended authentication [240](#)

F

F/W version [534](#)
 factory defaults [437](#)
 factory-default configuration file [51](#)
 FCC interference statement [655](#)
 file backup
 console port [548](#)
 file maintenance
 over WAN [546](#)
 file upload
 console port [554](#)
 FTP [553](#)
 TFTP [553](#)
 Xmodem [555](#)
 filename conventions [543](#)
 filter [464](#), [477](#), [488](#), [513](#)
 and NAT [524](#)
 applying [525](#)
 configuration [513](#)
 configuring [516](#)
 DMZ [526](#)
 example [522](#)
 filter rule execution [514](#)
 generic filter rule [520](#)
 incoming protocol [471](#)
 IP filter logic flow [519](#)
 protocol [471](#)
 remote node [527](#)
 structure [514](#)
 firewall
 action for matched packets [199](#)
 activating [511](#)
 address type [198](#)
 anti-probing [199](#)
 creating/editing rules [196](#)
 custom ports [204](#)
 DoS [202](#)
 Dos threshold [202](#)
 maximum incomplete high [202](#)
 maximum incomplete low [202](#)
 one minute high [202](#)
 one minute low [202](#)
 rules [181](#)
 rules for VPN [85](#), [89](#)
 service type [203](#)
 SMT menus [511](#)
 stateful inspection [181](#)
 TCP maximum incomplete [202](#)
 three-way handshake [200](#)
 threshold [201](#)
 VPN [89](#)
 when to use [525](#)
 firmware
 file maintenance [543](#)
 upload [433](#)

firmware upload [551](#)
 FTP [551](#)
 flow control [441](#)
 FTP [347](#), [365](#)
 commands [545](#)
 file upload [553](#)
 firmware upload [551](#)
 GUI-based clients [546](#)
 restoring files [549](#)

G

gateway IP address [474](#), [487](#), [492](#)
 general setup [423](#), [449](#)
 GMT [427](#)
 Greenwich Mean Time. See GMT.

H

H.323 [384](#)
 RTP [384](#)
 Hello BPDU [137](#)
 hidden menus [442](#)
 HTTPS [352](#)
 example [354](#)
 HyperTerminal [548](#), [550](#), [555](#), [556](#)

I

IANA [124](#), [614](#)
 iCard [119](#)
 idle timeout [460](#), [484](#), [485](#)
 IGMP [125](#), [126](#)
 version [125](#)
 IKE SA
 aggressive mode [234](#), [240](#)
 and certificates [239](#)
 and RADIUS [240](#)
 authentication algorithms [237](#), [243](#)
 Diffie-Hellman key group [238](#)
 encryption algorithms [237](#), [243](#)
 extended authentication [240](#)
 ID content [238](#)
 ID type [238](#)
 IP address, remote IPSec router [235](#)
 IP address, ZyXEL Device [235](#)
 local identity [239](#)
 main mode [234](#), [240](#)

- NAT traversal [241](#)
- negotiation mode [234](#)
- password [240](#)
- peer identity [239](#)
- pre-shared key [238](#)
- proposal [237](#)
- SA life time [241](#)
- user name [240](#)

IKE SA. See also VPN.

incoming protocol filter [471](#)

Internet access setup [67](#), [473](#)

Internet Assigned Number Authority. See IANA.

Internet Assigned Numbers Authority See IANA [614](#)

Internet Protocol Security. See IPSec.

IP address

- assignment [474](#), [487](#)
- pool [125](#), [128](#), [163](#), [173](#), [469](#)
- private [124](#)

IP alias [471](#)

IP alias setup [471](#)

- DMZ [479](#)

IP protocol type [198](#)

IP static route [491](#)

- active [492](#)
- destination IP address [492](#)
- name [492](#)
- route number [492](#)

IPSec [233](#)

IPSec SA

- active protocol [251](#)
- authentication algorithms [237](#), [243](#)
- authentication key (manual keys) [259](#)
- encapsulation [251](#)
- encryption algorithms [237](#), [243](#)
- encryption key (manual keys) [259](#)
- local policy [249](#)
- manual keys [259](#)
- nail up [242](#)
- Perfect Forward Secrecy (PFS) [252](#)
- proposal [252](#)
- remote policy [249](#)
- SA life time [241](#)
- Security Parameter Index (SPI) (manual keys) [259](#)
- transport mode [251](#)
- tunnel mode [251](#)
 - when IKE SA is disconnected [242](#), [249](#)

IPSec SA. See also VPN.

IPSec. See also VPN.

ISP parameters [68](#)

L

LAN [126](#)

- port filter setup [467](#)
 - setup [467](#)
- license key [119](#)
- link type [57](#)
- loading a configuration file [436](#)
- log [534](#)
- log and trace [534](#)
- log facility [536](#)
- login screen [442](#)

M

MAC address [144](#), [456](#)

main menu commands [442](#)

maintenance [423](#)

Management Information Base. See MIB.

managing subscription services [117](#)

managing the device

- good habits [47](#)
- using FTP. See FTP.
- using Telnet. See command interface.
- using the command interface. See command interface.

Max Age [137](#)

maximum incomplete high [202](#)

maximum incomplete low [202](#)

Media Access Control. See MAC address.

menu overview [445](#)

metric [141](#), [323](#), [462](#), [485](#), [488](#), [492](#)

MIB [366](#)

multicast [125](#), [173](#), [463](#), [470](#), [488](#)

myZyXEL.com [117](#)

N

nail-up connection [484](#), [486](#)

NAT [124](#), [307](#), [315](#), [316](#), [462](#), [474](#), [487](#), [524](#), [614](#)

- and VPN [241](#)
 - application [309](#)
 - configuring [495](#)
 - default server IP address [315](#)
 - definitions [307](#)
 - examples [502](#)
 - how NAT works [308](#)
 - in the SMT [493](#)
 - inside global address [307](#)
 - inside local address [307](#)
 - Many to Many No Overload [310](#)
 - Many to Many Overload [310](#)

- Many to One [310](#)
- mapping types [310](#)
- NAT unfriendly applications [507](#)
- One to One [310](#)
- ordering rules [498](#)
- port forwarding [315](#)
- port restricted cone [309](#)
- Server [310](#)
- server set [495](#)
- Single User Account [311](#)
- trigger port forwarding [509](#)
- what NAT does [308](#)
- NAT traversal [241](#), [373](#)
- navigation panel [58](#)
- NBNS [126](#), [128](#)
- NetBIOS [128](#)
- NetBIOS Name Server. See NBNS.
- Network Address Translation. See NAT.
- Network Basic Input/Output System. See NetBIOS.
- NTP time protocol [427](#)

O

- one minute high [202](#)
- one minute low [202](#)
- online services center [117](#)
- outgoing protocol filter [471](#)

P

- packet filtering [524](#)
- PAP [460](#), [485](#)
- parity [441](#)
- password [49](#), [424](#), [442](#)
- path cost [136](#)
- Perfect Forward Secrecy. see PFS.
- PFS [252](#)
 - Diffie-Hellman key group [252](#)
- PIN number [119](#)
- ping [540](#)
- Point-to-Point Protocol over Ethernet. See PPPoE
- Point-to-Point Tunneling Protocol. See PPTP.
- pool of IP addresses [125](#), [128](#)
- port filter setup
 - DMZ [477](#)
 - LAN [467](#)
- port forwarding [315](#)
- port restricted cone NAT [309](#)

- port statistics [62](#)
- Power Specification [581](#)
- PPP [461](#)
- PPP options [461](#)
- PPPoE
 - client [475](#)
 - encapsulation [69](#), [147](#), [473](#), [476](#), [482](#), [483](#), [484](#)
 - idle timeout [476](#)
- PPTP [70](#), [150](#)
 - Client [475](#)
 - configuring a client [475](#)
 - encapsulation [70](#), [150](#), [485](#)
 - idle timeout [475](#)
- private [323](#), [462](#), [488](#), [492](#)
- private IP address [124](#), [143](#)
- product overview [45](#)
- product registration [657](#)
- protocol filter [471](#)
 - incoming [471](#)
 - outgoing [471](#)

R

- RADIUS [299](#)
 - and IKE SA [240](#)
 - Shared Secret Key [300](#)
- RADIUS Message Types [299](#)
- RADIUS Messages [299](#)
- Rapid Spanning Tree Protocol. See Rapid STP.
- Rapid STP [136](#)
- Real time Transport Protocol. See RTP.
- registering your ZyWALL [118](#)
- registration
 - product [657](#)
- related documentation [3](#)
- reload factory-default configuration file [51](#)
- remote management [352](#), [565](#)
 - CNM [370](#)
 - DNS [369](#)
 - FTP [365](#)
 - how SSH works [359](#)
 - HTTPS [352](#)
 - HTTPS example [354](#)
 - limitations [352](#), [567](#)
 - secure FTP using SSH [363](#)
 - secure telnet using SSH [361](#)
 - SNMP [366](#)
 - SSH [359](#)
 - SSH implementation [360](#)
 - system timeout [352](#)
 - Telnet [364](#)
 - WWW [353](#)

- remote node [481](#)
 - filter [464](#), [488](#)
 - reports [397](#)
 - host IP address [398](#), [399](#)
 - protocol/port [398](#), [400](#)
 - web site hits [398](#), [399](#)
 - required fields [443](#)
 - reset button [51](#)
 - resetting the time [428](#)
 - resetting the ZyWALL [51](#)
 - restore configuration [436](#), [549](#)
 - via console port [555](#)
 - restoring factory defaults [437](#)
 - restoring files
 - via console port [550](#)
 - via FTP [549](#)
 - retry count [459](#)
 - retry interval [459](#)
 - RFC 1058. See RIP.
 - RFC 1305. See NTP time protocol.
 - RFC 1389. See RIP.
 - RFC 1466. See IP address.
 - RFC 1597. See private IP address.
 - RFC 1631. See NAT.
 - RFC 1889. See RTP.
 - RFC 2131. See DHCP.
 - RFC 2132. See DHCP
 - RFC 2402. See AH.
 - RFC 2406. See ESP.
 - RFC 3489. See STUN.
 - RFC 867. See Daytime time protocol.
 - RFC 868. See Time protocol.
 - RIP [125](#), [462](#), [470](#), [471](#), [488](#)
 - direction [125](#), [471](#)
 - version [125](#), [471](#), [488](#)
 - Routing Information Protocol. See RIP.
 - RSTP [136](#)
 - RTC [425](#), [561](#)
 - RTP [384](#)
- ## S
- SA
 - life time [241](#)
 - safety warnings [6](#)
 - schedule [483](#), [486](#)
 - duration [570](#)
 - scheduler [327](#)
 - secure FTP using SSH [363](#)
 - secure Telnet using SSH [361](#)
 - security associations. See VPN.
 - security settings for VPN traffic [85](#)
 - server set [495](#)
 - service type [203](#), [474](#), [482](#)
 - services [117](#)
 - Session Initiation Protocol. See SIP.
 - Simple Traversal of User Datagram Protocol (UDP) through Network Address Translators. See STUN.
 - Single User Account. See SUA.
 - SIP [385](#)
 - RTP [384](#)
 - SIP ALG [383](#)
 - SMT [441](#)
 - changing the password [446](#)
 - entering information [443](#)
 - general setup [449](#)
 - hidden menus [442](#)
 - initial screen [441](#)
 - login screen [442](#)
 - main menu commands [442](#)
 - menu overview [445](#)
 - navigation [442](#)
 - password [442](#)
 - required fields [443](#)
 - SNMP [366](#)
 - community [529](#)
 - configuration [529](#)
 - Get [367](#)
 - GetNext [367](#)
 - manager [366](#)
 - MIB [366](#), [367](#)
 - password [529](#)
 - Set [367](#)
 - Trap [367](#)
 - trusted host [529](#)
 - source address [198](#)
 - Spanning Tree Protocol. See STP.
 - SSH [359](#)
 - how SSH works [359](#)
 - implementation [360](#)
 - stateful inspection firewall [181](#)
 - static route [321](#), [491](#)
 - stop bit [441](#)
 - STP [136](#)
 - BPDU [136](#)
 - Hello BPDU [137](#)
 - how it works [136](#)
 - Max Age [137](#)
 - port states [137](#)
 - STUN [385](#)
 - SUA [493](#)
 - subnet [607](#)
 - subnet mask [123](#), [608](#)
 - subnetting [610](#)

subscription services [117](#)
 syntax conventions [4](#)
 syslog logging [535](#)
 system
 information [531](#)
 maintenance [531](#)
 name [423](#), [449](#)
 status [531](#)
 timeout [352](#)
 System Management Terminal. See SMT.

T

target market [45](#)
 TCP maximum incomplete [202](#)
 TCP/IP [486](#)
 and DHCP Ethernet setup [468](#)
 filter rule [518](#)
 setup [470](#)
 Telnet [364](#)
 terminal emulation [441](#)
 TFTP
 configuration backup [547](#)
 file upload [553](#)
 GUI-based clients [547](#)
 threshold [201](#)
 time [425](#)
 and date setting [561](#)
 Daylight Saving Time [427](#)
 resetting [428](#)
 synchronization with server [428](#)
 zone [427](#), [563](#)
 Time protocol [427](#)
 time protocol [427](#)
 Daytime [427](#)
 NTP [427](#)
 Time [427](#)
 time setting [561](#)
 timeout
 system [352](#)
 trace [534](#)
 trademarks [655](#)
 traffic
 redirect [153](#)
 transparent firewall [55](#), [137](#), [430](#), [432](#)
 triangle routes [190](#)
 vs virtual interfaces [190](#)
 trigger port forwarding [509](#)
 Trivial File Transfer Protocol. See TFTP.

U

unicast [125](#)
 Universal Plug and Play. See UPnP.
 upgrading firmware [433](#)
 upload [555](#)
 firmware [551](#)
 UPnP [373](#), [374](#)
 examples [376](#)
 forum [374](#)
 NAT traversal [373](#)
 port mapping [375](#)
 UPnP Implementers Corp. [374](#)
 user profiles [299](#)

V

Vantage CNM [369](#)
 virtual interfaces
 vs asymmetrical routes [190](#)
 vs triangle routes [190](#)
 Virtual Private Network. See VPN.
 VPN [150](#), [233](#)
 active protocol [251](#)
 adjust TCP maximum segment size [265](#)
 and NAT [241](#)
 and the firewall [85](#)
 certificate [246](#)
 established in two phases [234](#)
 gateway policy [76](#), [236](#), [243](#)
 IKE SA. See IKE SA.
 IPSec [233](#)
 IPSec SA. See IPSec SA.
 local network [233](#)
 network policy [77](#), [236](#), [253](#)
 pre-shared key [246](#)
 proposal [237](#)
 remote IPSec router [233](#)
 remote network [233](#)
 security associations (SA) [234](#)
 security on traffic [85](#)
 VPN. See also IKE SA, IPSec SA.
 VT100 terminal emulation [441](#)

W

WAN
 file maintenance [546](#)
 WAN DHCP [540](#)
 WAN IP address [143](#)

WAN setup [455](#)
warranty [656](#)
 note [656](#)
web configurator [49](#)
web site hits [398](#), [399](#)
Windows Internet Naming Service. See WINS.
WINS [126](#), [128](#)
WINS server [128](#)
wizard setup [67](#)
WWW [353](#)
www.dyndns.org [453](#)

X

Xmodem [555](#)
 file upload [555](#)
 protocol [544](#)

Z

ZyNOS [534](#), [544](#)
ZyWALL registration [118](#)
ZyXEL's Network Operating System. See ZyNOS.