

ZyWALL 10W/30W/50/100

Internet Security Gateway

User's Guide

Version 3.62

February 2004



Copyright

Copyright © 2004 by ZyXEL Communications Corporation.

The contents of this publication may not be reproduced in any part or as a whole, transcribed, stored in a retrieval system, translated into any language, or transmitted in any form or by any means, electronic, mechanical, magnetic, optical, chemical, photocopying, manual, or otherwise, without the prior written permission of ZyXEL Communications Corporation.

Published by ZyXEL Communications Corporation. All rights reserved.

Disclaimer

ZyXEL does not assume any liability arising out of the application or use of any products, or software described herein. Neither does it convey any license under its patent rights nor the patent rights of others. ZyXEL further reserves the right to make changes in any products described herein without notice.

This publication is subject to change without notice.

Trademarks

Trademarks mentioned in this publication are used for identification purposes only and may be properties of their respective owners.

Federal Communications Commission (FCC) Interference Statement

This device complies with Part 15 of FCC rules. Operation is subject to the following two conditions:

This device may not cause harmful interference.

This device must accept any interference received, including interference that may cause undesired operations.

This equipment has been tested and found to comply with the limits for a CLASS B digital device pursuant to Part 15 of the FCC Rules. These limits are designed to provide reasonable protection against harmful interference in a commercial environment. This equipment generates, uses, and can radiate radio frequency energy, and if not installed and used in accordance with the instructions, may cause harmful interference to radio communications.

If this equipment does cause harmful interference to radio/television reception, which can be determined by turning the equipment off and on, the user is encouraged to try to correct the interference by one or more of the following measures:

Reorient or relocate the receiving antenna.

Increase the separation between the equipment and the receiver.

Connect the equipment into an outlet on a circuit different from that to which the receiver is connected.

Consult the dealer or an experienced radio/TV technician for help.

Notice 1

Changes or modifications not expressly approved by the party responsible for compliance could void the user's authority to operate the equipment.

Certifications

1. Go to www.zyxel.com.
2. Select your product from the drop-down list box on the ZyXEL home page to go to that product's page.
3. Select the certification you wish to view from this page.

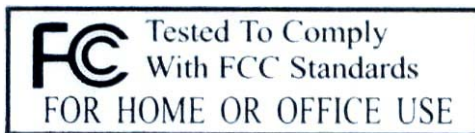

Information for Canadian Users

The Industry Canada label identifies certified equipment. This certification means that the equipment meets certain telecommunications network protective, operation, and safety requirements. The Industry Canada does not guarantee that the equipment will operate to a user's satisfaction.

Before installing this equipment, users should ensure that it is permissible to be connected to the facilities of the local telecommunications company. The equipment must also be installed using an acceptable method of connection. In some cases, the company's inside wiring associated with a single line individual service may be extended by means of a certified connector assembly. The customer should be aware that the compliance with the above conditions may not prevent degradation of service in some situations.

Repairs to certified equipment should be made by an authorized Canadian maintenance facility designated by the supplier. Any repairs or alterations made by the user to this equipment, or equipment malfunctions, may give the telecommunications company cause to request the user to disconnect the equipment.

For their own protection, users should ensure that the electrical ground connections of the power utility, telephone lines, and internal metallic water pipe system, if present, are connected together. This precaution may be particularly important in rural areas.

Caution

Users should not attempt to make such connections themselves, but should contact the appropriate electrical inspection authority, or electrician, as appropriate.

Note

This digital apparatus does not exceed the class A limits for radio noise emissions from digital apparatus set out in the radio interference regulations of Industry Canada.

ZyXEL Limited Warranty

ZyXEL warrants to the original end user (purchaser) that this product is free from any defects in materials or workmanship for a period of up to two years from the date of purchase. During the warranty period, and upon proof of purchase, should the product have indications of failure due to faulty workmanship and/or materials, ZyXEL will, at its discretion, repair or replace the defective products or components without charge for either parts or labor, and to whatever extent it shall deem necessary to restore the product or components to proper operating condition. Any replacement will consist of a new or re-manufactured functionally equivalent product of equal value, and will be solely at the discretion of ZyXEL. This warranty shall not apply if the product is modified, misused, tampered with, damaged by an act of God, or subjected to abnormal working conditions.

NOTE

Repair or replacement, as provided under this warranty, is the exclusive remedy of the purchaser. This warranty is in lieu of all other warranties, express or implied, including any implied warranty of merchantability or fitness for a particular use or purpose. ZyXEL shall in no event be held liable for indirect or consequential damages of any kind of character to the purchaser.

To obtain the services of this warranty, contact ZyXEL's Service Center for your Return Material Authorization number (RMA). Products must be returned Postage Prepaid. It is recommended that the unit be insured when shipped. Any returned products without proof of purchase or those with an out-dated warranty will be repaired or replaced (at the discretion of ZyXEL) and the customer will be billed for parts and labor. All repaired or replaced products will be shipped by ZyXEL to the corresponding return address, Postage Paid. This warranty gives you specific legal rights, and you may also have other rights that vary from country to country.



Online Registration

Register your product online to receive e-mail notices of firmware upgrades and information at www.zyxel.com for global products, or at www.us.zyxel.com for North American products.

Customer Support

When you contact your customer support representative please have the following information ready:
Please have the following information ready when you contact customer support (see the next page for contact information).

- Product model and serial number.
- Information in **Menu 24.2.1 – System Information**.
- Warranty Information.
- Date that you received your device.
- Brief description of the problem and the steps you took to solve it.

METHOD LOCATION	SUPPORT E-MAIL	TELEPHONE ¹	WEB SITE	REGULAR MAIL
	SALES E-MAIL	FAX ¹	FTP SITE	
WORLDWIDE	support@zyxel.com.tw sales@zyxel.com.tw	+886-3-578-3942 +886-3-578-2439	www.zyxel.com www.europe.zyxel.com ftp.zyxel.com ftp.europe.zyxel.com	ZyXEL Communications Corp. 6 Innovation Road II Science Park Hsinchu 300 Taiwan
NORTH AMERICA	support@zyxel.com sales@zyxel.com	+1-800-255-4101 +1-714-632-0882 +1-714-632-0858	www.us.zyxel.com ftp.us.zyxel.com	ZyXEL Communications Inc. 1130 N. Miller St. Anaheim CA 92806-2001 U.S.A.
GERMANY	support@zyxel.de sales@zyxel.de	+49-2405-6909-0 +49-2405-6909-99	www.zyxel.de	ZyXEL Deutschland GmbH. Adenauerstr. 20/A2 D-52146 Wuerselen Germany
FRANCE	info@zyxel.fr	+33 (0)4 72 52 97 97 +33 (0)4 72 52 19 20	www.zyxel.fr	ZyXEL France 1 rue des Vergers Bat. 1 / C 69760 Limonest France
SPAIN	support@zyxel.es sales@zyxel.es	+34 902 195 420 +34 913 005 345	www.zyxel.es	ZyXEL Communications Alejandro Villegas 33 1º, 28043 Madrid Spain
DENMARK	support@zyxel.dk sales@zyxel.dk	+45 39 55 07 00 +45 39 55 07 07	www.zyxel.dk	ZyXEL Communications A/S Columbusvej 5 2860 Soeborg Denmark
NORWAY	support@zyxel.no sales@zyxel.no	+47 22 80 61 80 +47 22 80 61 81	www.zyxel.no	ZyXEL Communications A/S Nils Hansens vei 13 0667 Oslo Norway
SWEDEN	support@zyxel.se sales@zyxel.se	+46 31 744 7700 +46 31 744 7701	www.zyxel.se	ZyXEL Communications A/S Sjöporten 4, 41764 Göteborg Sweden
FINLAND	support@zyxel.fi sales@zyxel.fi	+358-9-4780-8411 +358-9-4780 8448	www.zyxel.fi	ZyXEL Communications Oy Malminkaari 10 00700 Helsinki Finland

¹ “+” is the (prefix) number you enter to make an international telephone call.

Table of Contents

Copyright.....	ii
Federal Communications Commission (FCC) Interference Statement.....	iii
Information for Canadian Users	iv
ZyXEL Limited Warranty	v
Customer Support	vi
List of Figures	xxi
List of Tables	xxxiii
Preface	xxxix
Getting Started	I
Chapter 1 Getting to Know Your ZyWALL	1-1
1.1 ZyWALL Internet Security Gateway Overview	1-1
1.2 ZyWALL Features	1-1
1.3 Applications for the ZyWALL.....	1-9
Chapter 2 Introducing the Web Configurator	2-1
2.1 Web Configurator Overview	2-1
2.2 Accessing the ZyWALL Web Configurator.....	2-1
2.3 Resetting the ZyWALL.....	2-2
2.4 Navigating the ZyWALL Web Configurator	2-4
Chapter 3 Wizard Setup.....	3-1
3.1 Wizard Setup Overview	3-1
3.2 Wizard Setup: General Setup and System Name	3-1
3.3 Wizard Setup: Screen 2	3-2
3.4 Wizard Setup: Screen 3	3-8
3.5 Basic Setup Complete	3-12
System, LAN and Wireless LAN.....	II

Chapter 4 System Screens	4-1
4.1 System Overview	4-1
4.2 DNS Overview.....	4-1
4.3 Configuring General Setup	4-1
4.4 Dynamic DNS.....	4-3
4.5 Configuring Dynamic DNS	4-3
4.6 Configuring Password.....	4-5
4.7 Pre-defined NTP Time Servers List.....	4-6
4.8 Configuring Time Setting	4-7
Chapter 5 LAN Screens	5-1
5.1 LAN Overview	5-1
5.2 DHCP Setup.....	5-1
5.3 LAN TCP/IP	5-1
5.4 Configuring IP	5-3
5.5 Configuring Static DHCP	5-6
5.6 Configuring IP Alias	5-7
Chapter 6 Wireless LAN Screens	6-1
6.1 Wireless LAN Overview.....	6-1
6.2 Wireless LAN Basics.....	6-1
6.3 Wireless Security	6-3
6.4 Configuring Wireless LAN.....	6-4
6.5 Configuring MAC Filter	6-6
6.6 802.1x Overview.....	6-8
6.7 Configuring 802.1X.....	6-8
DMZ and WAN	III
Chapter 7 DMZ Screens	7-1
7.1 DMZ Overview.....	7-1
7.2 DMZ Addresses	7-1

7.3	Configuring DMZ	7-1
Chapter 8 WAN Screens		8-1
8.1	WAN Overview	8-1
8.2	TCP/IP Priority (Metric)	8-1
8.3	Configuring Route.....	8-1
8.4	Configuring WAN ISP.....	8-2
8.5	Configuring WAN IP	8-8
8.6	Configuring WAN MAC.....	8-11
8.7	Traffic Redirect	8-12
8.8	Configuring Traffic Redirect.....	8-13
8.9	Configuring Dial Backup	8-15
8.10	Advanced Modem Setup	8-20
8.11	Configuring Advanced Modem Setup.....	8-21
NAT and Static Route		IV
Chapter 9 Network Address Translation (NAT) Screens.....		9-1
9.1	NAT Overview.....	9-1
9.2	Using NAT	9-5
9.3	SUA Server	9-6
9.4	Configuring SUA Server.....	9-8
9.5	Configuring Address Mapping.....	9-10
9.6	Trigger Port Forwarding.....	9-13
9.7	Configuring Trigger Port Forwarding	9-14
Chapter 10 Static Route Screens		10-1
10.1	Static Route Overview	10-1
10.2	Configuring IP Static Route.....	10-1
Firewall and Content Filtering.....		V
Chapter 11 Firewalls.....		11-1
11.1	Firewall Overview.....	11-1

11.2	Types of Firewalls.....	11-1
11.3	Introduction to ZyXEL’s Firewall	11-2
11.4	Denial of Service.....	11-3
11.5	Stateful Inspection	11-7
11.6	Guidelines For Enhancing Security With Your Firewall	11-11
11.7	Packet Filtering Vs Firewall	11-12
Chapter 12 Firewall Screens.....		12-1
12.1	Access Methods	12-1
12.2	Firewall Policies Overview	12-1
12.3	Rule Logic Overview	12-2
12.4	Connection Direction Examples	12-4
12.5	Bandwidth Management - Lite	12-5
12.6	Bandwidth Management Usage Examples.....	12-5
12.7	Alerts.....	12-7
12.8	Configuring Firewall.....	12-7
12.9	Example Firewall Rule	12-17
12.10	Predefined Services.....	12-21
12.11	Configuring Attack Alert	12-24
Chapter 13 Content Filtering Screens		13-1
13.1	Content Filtering Overview	13-1
13.2	General Content Filter Configuration	13-1
13.3	Content Filtering with an External Server	13-4
13.4	A Procedure to Enable External Database Content Filtering	13-5
13.5	Checking Content Filtering Activation	13-6
13.6	Configuring Categories.....	13-6
13.7	Configuring Customization.....	13-15
VPN/IPSec.....		VI
Chapter 14 Introduction to IPSec		14-1

14.1	VPN Overview	14-1
14.2	IPSec Architecture	14-2
14.3	Encapsulation	14-3
14.4	IPSec and NAT	14-4
Chapter 15	VPN Screens	15-1
15.1	VPN/IPSec Overview	15-1
15.2	IPSec Algorithms	15-1
15.3	My IP Address	15-2
15.4	Secure Gateway Address	15-2
15.5	VPN Rules Screen	15-3
15.6	Keep Alive	15-6
15.7	NAT Traversal	15-6
15.8	ID Type and Content	15-8
15.9	Pre-Shared Key	15-10
15.10	Certificates	15-10
15.11	Editing VPN Policies	15-10
15.12	IKE Phases	15-19
15.13	Configuring Advanced IKE Settings	15-21
15.14	Manual Key Setup	15-25
15.15	Configuring Manual Key	15-25
15.16	Viewing SA Monitor	15-29
15.17	Configuring Global Setting	15-31
15.18	Telecommuter VPN/IPSec Examples	15-32
15.19	VPN and Remote Management	15-35
Certificates	VII
Chapter 16	Certificates	16-1
16.1	Certificates Overview	16-1
16.2	Self-signed Certificates	16-2

16.3	Configuration Summary.....	16-2
16.4	My Certificates	16-3
16.5	Certificate File Formats	16-6
16.6	Importing a Certificate	16-7
16.7	Creating a Certificate	16-8
16.8	My Certificate Details.....	16-12
16.9	Trusted CAs	16-16
16.10	Importing a Trusted CA's Certificate	16-18
16.11	Trusted CA Certificate Details.....	16-19
16.12	Trusted Remote Hosts.....	16-23
16.13	Verifying a Trusted Remote Host's Certificate.....	16-25
16.14	Importing a Trusted Remote Host's Certificate	16-27
16.15	Trusted Remote Host Certificate Details	16-28
16.16	Directory Servers	16-32
16.17	Add or Edit a Directory Server	16-33
Authentication Server, Remote Management and UPnP		VIII
Chapter 17 Authentication Server		17-1
17.1	Authentication Server Overview.....	17-1
17.2	Local User Database	17-1
17.3	Configuring Local User Database.....	17-1
17.4	Configuring RADIUS	17-5
Chapter 18 Remote Management Screens.....		18-1
18.1	Remote Management Overview.....	18-1
18.2	Introduction to HTTPS	18-2
18.3	Configuring WWW.....	18-4
18.4	HTTPS Login Example.....	18-6
18.5	SSH Overview	18-14
18.6	How SSH works.....	18-15

18.7	SSH Implementation on the ZyWALL	18-16
18.8	Configuring SSH.....	18-16
18.9	Secure Telnet Using SSH Examples	18-17
18.10	Secure FTP Using SSH Example	18-19
18.11	Telnet	18-20
18.12	Configuring TELNET	18-21
18.13	Configuring FTP	18-22
18.14	Configuring SNMP	18-23
18.15	Configuring DNS	18-27
18.16	Configuring Security	18-28
Chapter 19 UPnP		19-1
19.1	Universal Plug and Play Overview	19-1
19.2	UPnP and ZyXEL	19-2
19.3	Configuring UPnP	19-2
19.4	Displaying UPnP Port Mapping.....	19-4
19.5	Installing UPnP in Windows Example	19-5
19.6	Using UPnP in Windows XP Example	19-7
Logs		IX
Chapter 20 Logs Screens.....		20-1
20.1	Configuring View Log	20-1
20.2	Configuring Log Settings	20-3
20.3	Configuring Reports.....	20-6
Maintenance		X
Chapter 21 Maintenance.....		21-1
21.1	Maintenance Overview	21-1
21.2	Status Screen	21-1
21.3	DHCP Table Screen	21-4
21.4	F/W Upload Screen	21-5

21.5	Configuration Screen	21-7
21.6	Restart Screen	21-11
SMT General Configuration		XI
Chapter 22 Introducing the SMT		22-1
22.1	Introduction to the SMT	22-1
22.2	Accessing the SMT via the Console Port	22-1
22.3	Navigating the SMT Interface	22-2
22.4	Changing the System Password	22-7
22.5	Resetting the ZyWALL	22-8
Chapter 23 SMT Menu 1 - General Setup		23-1
23.1	Introduction to General Setup	23-1
23.2	Configuring General Setup	23-1
Chapter 24 WAN and Dial Backup Setup		24-1
24.1	Introduction to WAN and Dial Backup Setup	24-1
24.2	WAN Setup	24-1
24.3	Dial Backup	24-2
24.4	Configuring Dial Backup in Menu 2	24-2
24.5	Advanced WAN Setup	24-4
24.6	Remote Node Profile (Backup ISP)	24-6
24.7	Editing PPP Options	24-8
24.8	Editing TCP/IP Options	24-9
24.9	Editing Login Script	24-11
24.10	Remote Node Filter	24-13
Chapter 25 LAN Setup		25-1
25.1	Introduction to LAN Setup	25-1
25.2	Accessing the LAN Menus	25-1
25.3	LAN Port Filter Setup	25-1
25.4	TCP/IP and DHCP Ethernet Setup Menu	25-2

25.5	Wireless LAN Setup	25-7
Chapter 26	DMZ Setup	26-1
26.1	Configuring DMZ Setup	26-1
26.2	DMZ Port Filter Setup.....	26-1
26.3	TCP/IP Setup.....	26-2
Chapter 27	Internet Access	27-1
27.1	Introduction to Internet Access Setup	27-1
27.2	Ethernet Encapsulation.....	27-1
27.3	Configuring the PPTP Client.....	27-3
27.4	Configuring the PPPoE Client.....	27-4
27.5	Basic Setup Complete	27-5
SMT Advanced Applications		XII
Chapter 28	Remote Node Setup.....	28-1
28.1	Introduction to Remote Node Setup.....	28-1
28.2	Remote Node Setup.....	28-1
28.3	Remote Node Profile Setup.....	28-2
28.4	Edit IP	28-8
28.5	Remote Node Filter	28-10
Chapter 29	IP Static Route Setup	29-1
29.1	IP Static Route Setup.....	29-1
Chapter 30	Network Address Translation (NAT)	30-1
30.1	Using NAT.....	30-1
30.2	NAT Setup	30-4
30.3	Configuring a Server behind NAT	30-9
30.4	General NAT Examples	30-10
30.5	Configuring Trigger Port Forwarding	30-18
Chapter 31	Introducing the ZyWALL Firewall	31-1
31.1	Using ZyWALL SMT Menus	31-1

Chapter 32 Filter Configuration	32-1
32.1 Introduction to Filters	32-1
32.2 Configuring a Filter Set	32-4
32.3 Example Filter.....	32-13
32.4 Filter Types and NAT	32-15
32.5 Firewall Versus Filters.....	32-16
32.6 Applying a Filter.....	32-16
Chapter 33 SNMP Configuration.....	33-1
33.1 SNMP Configuration	33-1
33.2 SNMP Traps	33-2
SMT System Maintenance	XIII
Chapter 34 System Information & Diagnosis	34-1
34.1 Introduction to System Status	34-1
34.2 System Status.....	34-1
34.3 System Information and Console Port Speed.....	34-3
34.4 Log and Trace	34-5
34.5 Diagnostic	34-11
Chapter 35 Firmware and Configuration File Maintenance.....	35-1
35.1 Introduction.....	35-1
35.2 Filename Conventions	35-1
35.3 Backup Configuration.....	35-2
35.4 Restore Configuration.....	35-8
35.5 Uploading Firmware and Configuration Files	35-11
Chapter 36 System Maintenance Menus 8 to 10.....	36-1
36.1 Command Interpreter Mode.....	36-1
36.2 Call Control Support.....	36-3
36.3 Time and Date Setting	36-6
Chapter 37 Remote Management	37-1

37.1	Remote Management.....	37-1
SMT Advanced Management.....		XIV
Chapter 38 IP Policy Routing		38-1
38.1	Introduction to IP Policy Routing	38-1
38.2	Benefits	38-1
38.3	Routing Policy.....	38-1
38.4	IP Routing Policy Setup	38-2
38.5	Applying an IP Policy	38-6
38.6	IP Policy Routing Example.....	38-6
Chapter 39 Call Scheduling		39-1
39.1	Introduction to Call Scheduling	39-1
Chapter 40 VPN/IPSec Setup		40-1
40.1	Introduction.....	40-1
40.2	IPSec Summary Screen.....	40-2
40.3	IPSec Setup	40-5
40.4	IKE Setup.....	40-12
40.5	Manual Setup	40-14
Chapter 41 SA Monitor		41-1
41.1	Introduction.....	41-1
41.2	Using SA Monitor	41-1
Troubleshooting and Hardware Appendices.....		XV
Appendix A Troubleshooting		A-1
Appendix B Hardware Specifications		B-1
Appendix C Safety Warnings and Instructions.....		C-1
Appendix D Removing and Installing a ZyWALL 100 Fuse.....		D-1
General Appendices		XVI
Appendix E Setting up Your Computer's IP Address.....		E-1
Appendix F Triangle Route.....		F-1

Appendix G The Big Picture	G-1
Appendix H Wireless LAN and IEEE 802.11	H-1
Appendix I Wireless LAN With IEEE 802.1x	I-1
Appendix J Types of EAP Authentication	J-1
Appendix K PPPoE	K-1
Appendix L PPTP	L-1
Appendix M IP Subnetting	M-1
Command, Log, Content Filtering and Certificates Appendices and Index	XVII
Appendix N Command Interpreter	N-1
Appendix O Firewall Commands	O-1
Appendix P NetBIOS Filter Commands	P-1
Appendix Q Certificate Commands	Q-1
Appendix R Boot Commands	R-1
Appendix S Log Descriptions	S-1
Appendix T Brute-Force Password Guessing Protection	T-1
Appendix U Importing Certificates	U-1
Appendix V Index	V-1

List of Figures

Figure 1-1 Secure Internet Access via Cable, DSL or Wireless Modem	1-9
Figure 1-2 VPN Application	1-10
Figure 2-1 Change Password Screen.....	2-1
Figure 2-2 Replace Certificate Screen	2-2
Figure 2-3 Example Xmodem Upload	2-3
Figure 2-4 Web Configurator MAIN MENU Screen.....	2-4
Figure 3-1 Wizard 1	3-2
Figure 3-2 Wizard 2: Ethernet Encapsulation	3-3
Figure 3-3 Wizard2: PPPoE Encapsulation.....	3-5
Figure 3-4 Wizard 2: PPTP Encapsulation.....	3-7
Figure 3-5 Wizard 3	3-10
Figure 4-1 System General Setup	4-1
Figure 4-2 DDNS.....	4-4
Figure 4-3 Password.....	4-5
Figure 4-4 Time Setting	4-7
Figure 5-1 IP	5-3
Figure 5-2 Static DHCP	5-6
Figure 5-3 Physical Network Figure 5-4 Partitioned Logical Networks.....	5-7
Figure 5-5 IP Alias	5-8
Figure 6-1 RTS Threshold.....	6-2
Figure 6-2 ZyWALL Wireless Security Levels.....	6-3
Figure 6-3 Wireless.....	6-4
Figure 6-4 MAC Address Filter	6-7
Figure 6-5 802.1X Authentication.....	6-8
Figure 7-1 DMZ (ZyWALL 100).....	7-2

Figure 8-1 WAN Setup: Route.....	8-2
Figure 8-2 Ethernet Encapsulation.....	8-3
Figure 8-3 PPPoE Encapsulation.....	8-5
Figure 8-4 PPTP Encapsulation.....	8-7
Figure 8-5 IP Setup.....	8-9
Figure 8-6 MAC Setup.....	8-12
Figure 8-7 Traffic Redirect WAN Setup.....	8-12
Figure 8-8 Traffic Redirect LAN Setup.....	8-13
Figure 8-9 Traffic Redirect.....	8-14
Figure 8-10 Dial Backup Setup.....	8-16
Figure 8-11 Advanced Setup.....	8-21
Figure 9-1 How NAT Works.....	9-3
Figure 9-2 NAT Application With IP Alias.....	9-4
Figure 9-3 Multiple Servers Behind NAT Example.....	9-8
Figure 9-4 SUA Server.....	9-9
Figure 9-5 Address Mapping.....	9-10
Figure 9-6Address Mapping Edit.....	9-12
Figure 9-7 Trigger Port Forwarding Process: Example.....	9-14
Figure 9-8 Trigger Port.....	9-15
Figure 10-1 Example of Static Routing Topology.....	10-1
Figure 10-2 IP Static Route.....	10-2
Figure 10-3 Edit IP Static Route.....	10-3
Figure 11-1 ZyWALL Firewall Application.....	11-3
Figure 11-2 Three-Way Handshake.....	11-5
Figure 11-3 SYN Flood.....	11-5
Figure 11-4 Smurf Attack.....	11-6
Figure 11-5 Stateful Inspection.....	11-8
Figure 12-1 LAN to WAN Traffic.....	12-4

Figure 12-2 WAN to LAN Traffic.....	12-5
Figure 12-3 Application-based Bandwidth Management Example.....	12-6
Figure 12-4 Subnet-based Bandwidth Management Example.....	12-6
Figure 12-5 Application and Subnet-based Bandwidth Management Example.....	12-7
Figure 12-6 Firewall Summary.....	12-8
Figure 12-7 Firewall Edit Rule.....	12-11
Figure 12-8 Source and Destination Addresses Add/Edit.....	12-14
Figure 12-9 Custom Port Create/Edit.....	12-15
Figure 12-10 BM Global Setting.....	12-16
Figure 12-11 Firewall Edit Rule Screen.....	12-18
Figure 12-12 Firewall Rule Edit IP Example.....	12-18
Figure 12-13 Edit Custom Port Example.....	12-19
Figure 12-14 My Service Rule Configuration.....	12-20
Figure 12-15 My Service Example Rule Summary.....	12-21
Figure 12-16 Attack Alert.....	12-26
Figure 13-1 Content Filtering General.....	13-2
Figure 13-2 Content Filtering Lookup Procedure.....	13-5
Figure 13-3 Content Filtering Categories.....	13-7
Figure 13-4 Content Filtering Customization.....	13-16
Figure 14-1 Encryption and Decryption.....	14-2
Figure 14-2 IPSec Architecture.....	14-3
Figure 14-3 Transport and Tunnel Mode IPSec Encapsulation.....	14-4
Figure 15-1 IPSec VPN Rules Fields.....	15-3
Figure 15-2 VPN Rules.....	15-4
Figure 15-3 NAT Router Between IPSec Routers.....	15-6
Figure 15-4 VPN Host using Intranet DNS Server Example.....	15-8
Figure 15-5 VPN IKE.....	15-11
Figure 15-6 Two Phases to Set Up the IPSec SA.....	15-19

Figure 15-7 VPN IKE: Advanced	15-22
Figure 15-8 VPN Manual Key	15-26
Figure 15-9 SA Monitor (ZyWALL 100).....	15-30
Figure 15-10 Global Setting	15-31
Figure 15-11 Telecommuters Sharing One VPN Rule Example	15-32
Figure 15-12 Telecommuters Using Unique VPN Rules Example	15-33
Figure 16-1 Certificate Configuration Overview	16-3
Figure 16-2 My Certificates.....	16-4
Figure 16-3 My Certificate Import	16-7
Figure 16-4 My Certificate Create.....	16-9
Figure 16-5 My Certificate Details	16-13
Figure 16-6 Trusted Cas.....	16-17
Figure 16-7 Trusted CA Import	16-19
Figure 16-8 Trusted CA Import	16-19
Figure 16-9 Trusted CA Details	16-20
Figure 16-10 Trusted Remote Hosts	16-24
Figure 16-11 Remote Host Certificates.....	16-26
Figure 16-12 Certificate Details.....	16-26
Figure 16-13 Trusted Remote Host Import	16-27
Figure 16-14 Trusted Remote Host Details.....	16-29
Figure 16-15 Directory Servers	16-32
Figure 16-16 Directory Server Add	16-34
Figure 17-1 Local User Database	17-2
Figure 17-2 EAP Authentication.....	17-5
Figure 17-3 RADIUS.....	17-6
Figure 18-1 HTTPS Implementation	18-3
Figure 18-2 WWW	18-4
Figure 18-3 Security Alert Dialog Box (Internet Explorer).....	18-6

Figure 18-4 Security Certificate Example (Netscape)	18-7
Figure 18-5 Security Certificate 2 Example (Netscape).....	18-8
Figure 18-6 Login Screen Example (Internet Explorer).....	18-10
Figure 18-7 Login Screen Example (Netscape)	18-11
Figure 18-8 Replace Certificate	18-12
Figure 18-9 Device-specific Certificate	18-13
Figure 18-10 Common ZyWALL Certificate	18-14
Figure 18-11 SSH Communication Example.....	18-15
Figure 18-12How SSH Works.....	18-15
Figure 18-13 Remote Management: SSH	18-16
Figure 18-14 SSH Example 1: Store Host Key.....	18-18
Figure 18-15 SSH Example 2: Test.....	18-18
Figure 18-16 SSH Example 2: Log in	18-19
Figure 18-17 Secure FTP: Firmware Upload Example	18-20
Figure 18-18 Telnet Configuration on a TCP/IP Network	18-21
Figure 18-19 Telnet	18-21
Figure 18-20 FTP	18-23
Figure 18-21 SNMP Management Model	18-24
Figure 18-22 SNMP	18-26
Figure 18-23 DNS.....	18-28
Figure 18-24 Security.....	18-29
Figure 19-1 Configuring UPnP	19-3
Figure 19-2 UPnP Ports	19-4
Figure 20-1 View Log	20-2
Figure 20-2 Log Settings.....	20-4
Figure 20-3 Reports	20-7
Figure 20-4 Web Site Hits Report Example	20-8
Figure 20-5 Protocol/Port Report Example.....	20-9

Figure 20-6 LAN IP Address Report Example	20-10
Figure 21-1 System Status	21-1
Figure 21-2 System Status: Show Statistics.....	21-3
Figure 21-3 DHCP Table	21-4
Figure 21-4 Firmware Upload	21-5
Figure 21-5 Firmware Upload	21-6
Figure 21-6 Firmware Upload In Process	21-6
Figure 21-7 Network Temporarily Disconnected.....	21-6
Figure 21-8 Firmware Upload Error	21-7
Figure 21-9 Configuration	21-8
Figure 21-10 Configuration Upload Successful.....	21-9
Figure 21-11 Network Temporarily Disconnected.....	21-9
Figure 21-12 Configuration Upload Error	21-10
Figure 21-13 Reset Warning Message	21-11
Figure 21-14 Restart Screen	21-11
Figure 22-1 Initial Screen	22-1
Figure 22-2 Password Screen	22-2
Figure 22-3 Main Menu (ZyWALL 100).....	22-3
Figure 22-4 Getting Started and Advanced Applications SMT Menus	22-5
Figure 22-5 Advanced Management SMT Menus	22-6
Figure 22-6 Schedule Setup and IPSec VPN Configuration SMT Menus.....	22-7
Figure 22-7 Menu 23: System Password	22-7
Figure 23-1 Menu 1: General Setup (ZyWALL 10W).....	23-1
Figure 23-2 Configure Dynamic DNS.....	23-3
Figure 24-1 MAC Address Cloning in WAN Setup.....	24-1
Figure 24-2 Menu 2: Dial Backup Setup	24-3
Figure 24-3 Menu 2.1 Advanced WAN Setup	24-4
Figure 24-4 Menu 11.1 Remote Node Profile (Backup ISP)	24-6

Figure 24-5 Menu 11.2: Remote Node PPP Options.....	24-9
Figure 24-6 Menu 11.3: Remote Node Network Layer Options.....	24-9
Figure 24-7 Menu 11.4: Remote Node Setup Script.....	24-12
Figure 24-8 Menu 11.5: Dial Backup Remote Node Filter.....	24-13
Figure 25-1 Menu 3: LAN Setup.....	25-1
Figure 25-2 Menu 3.1: LAN Port Filter Setup.....	25-2
Figure 25-3 Menu 3: TCP/IP and DHCP Setup.....	25-2
Figure 25-4 Menu 3.2: TCP/IP and DHCP Ethernet Setup.....	25-3
Figure 25-5 Menu 3.2.1: IP Alias Setup.....	25-6
Figure 25-6 Menu 3.5 – Wireless LAN Setup.....	25-7
Figure 25-7 Menu 3.5.1: WLAN MAC Address Filter.....	25-10
Figure 26-1 Menu 5: DMZ Setup.....	26-1
Figure 26-2 Menu 5.1: DMZ Port Filter Setup.....	26-1
Figure 26-3 Menu 5: TCP/IP Setup.....	26-2
Figure 26-4 Menu 5.2: TCP/IP Setup.....	26-2
Figure 26-5 Menu 5.2.1: IP Alias Setup.....	26-3
Figure 27-1 Menu 4: Internet Access Setup (Ethernet).....	27-1
Figure 27-2 Internet Access Setup (PPTP).....	27-4
Figure 27-3 Internet Access Setup (PPPoE).....	27-5
Figure 28-1 Menu 11 Remote Node Setup.....	28-2
Figure 28-2 Menu 11.1: Remote Node Profile for Ethernet Encapsulation.....	28-3
Figure 28-3 Menu 11.1: Remote Node Profile for PPPoE Encapsulation.....	28-5
Figure 28-4 Menu 11.1: Remote Node Profile for PPTP Encapsulation.....	28-7
Figure 28-5 Menu 11.3: Remote Node Network Layer Options for Ethernet Encapsulation.....	28-8
Figure 28-6 Menu 11.5: Remote Node Filter (Ethernet Encapsulation).....	28-11
Figure 28-7 Menu 11.5: Remote Node Filter (PPPoE or PPTP Encapsulation).....	28-11
Figure 28-8 Menu 11.1: Remote Node Profile.....	28-12
Figure 28-9 Menu 11.6: Traffic Redirect Setup.....	28-13

Figure 29-1 Menu 12: IP Static Route Setup	29-1
Figure 29-2 Menu 12. 1: Edit IP Static Route.....	29-2
Figure 30-1 Menu 4: Applying NAT for Internet Access.....	30-2
Figure 30-2 Menu 11.3: Applying NAT to the Remote Node.....	30-3
Figure 30-3 Menu 15: NAT Setup	30-4
Figure 30-4 Menu 15.1: Address Mapping Sets	30-5
Figure 30-5 Menu 15.1.255: SUA Address Mapping Rules	30-5
Figure 30-6 Menu 15.1.1: First Set.....	30-7
Figure 30-7 Menu 15.1.1.1: Editing/Configuring an Individual Rule in a Set.....	30-8
Figure 30-8 Menu 15.2: NAT Server Setup (ZyWALL 10W).....	30-10
Figure 30-9 Server Behind NAT Example.....	30-10
Figure 30-10 NAT Example 1	30-11
Figure 30-11 Menu 4: Internet Access & NAT Example	30-11
Figure 30-12 NAT Example 2.....	30-12
Figure 30-13 Menu 15.2: Specifying an Inside Server	30-12
Figure 30-14 NAT Example 3.....	30-13
Figure 30-15 Example 3: Menu 11.3	30-14
Figure 30-16 Example 3: Menu 15.1.1.1	30-15
Figure 30-17 Example 3: Final Menu 15.1.1	30-15
Figure 30-18 Example 3: Menu 15.2	30-16
Figure 30-19 NAT Example 4.....	30-16
Figure 30-20 Example 4: Menu 15.1.1.1: Address Mapping Rule	30-17
Figure 30-21 Example 4: Menu 15.1.1: Address Mapping Rules.....	30-18
Figure 30-22 Menu 15.3: Trigger Port Setup.....	30-19
Figure 31-1 Menu 21: Filter and Firewall Setup.....	31-1
Figure 31-2 Menu 21.2: Firewall Setup.....	31-2
Figure 32-1 Outgoing Packet Filtering Process	32-2
Figure 32-2 Filter Rule Process	32-3

Figure 32-4 Menu 21: Filter and Firewall Setup.....	32-4
Figure 32-5 Menu 21.1: Filter Set Configuration.....	32-4
Figure 32-6 Menu 21.1.1.1: TCP/IP Filter Rule.....	32-7
Figure 32-7 Executing an IP Filter.....	32-10
Figure 32-8 Menu 21.1.4.1: Generic Filter Rule.....	32-11
Figure 32-9 Telnet Filter Example.....	32-13
Figure 32-10 Example Filter: Menu 21.1.3.1.....	32-14
Figure 32-11 Example Filter Rules Summary: Menu 21.1.3.....	32-15
Figure 32-12 Protocol and Device Filter Sets.....	32-16
Figure 32-13 Filtering LAN Traffic.....	32-17
Figure 32-14 Filtering DMZ Traffic.....	32-18
Figure 32-15 Filtering Remote Node Traffic.....	32-18
Figure 33-1 Menu 22: SNMP Configuration.....	33-1
Figure 34-1 Menu 24: System Maintenance.....	34-1
Figure 34-2 Menu 24.1: System Maintenance: Status (ZyWALL 100).....	34-2
Figure 34-3 Menu 24.2: System Information and Console Port Speed.....	34-4
Figure 34-4 Menu 24.2.1: System Maintenance: Information (ZyWALL 10W).....	34-4
Figure 34-5 Menu 24.2.2: System Maintenance: Change Console Port Speed.....	34-5
Figure 34-6 Menu 24.3: System Maintenance: Log and Trace.....	34-6
Figure 34-7 Examples of Error and Information Messages.....	34-7
Figure 34-8 Menu 24.3.2: System Maintenance: Syslog Logging.....	34-7
Figure 34-9 Call-Triggering Packet Example.....	34-11
Figure 34-10 Menu 24.4: System Maintenance: Diagnostic.....	34-12
Figure 34-11 LAN & WAN DHCP.....	34-13
Figure 35-1 Telnet into Menu 24.5.....	35-3
Figure 35-2 FTP Session Example.....	35-4
Figure 35-3 System Maintenance: Backup Configuration.....	35-7
Figure 35-4 System Maintenance: Starting Xmodem Download Screen.....	35-7

Figure 35-5 Backup Configuration Example	35-7
Figure 35-6 Successful Backup Confirmation Screen	35-8
Figure 35-7 Telnet into Menu 24.6	35-9
Figure 35-8 Restore Using FTP Session Example	35-10
Figure 35-9 System Maintenance: Restore Configuration.....	35-10
Figure 35-10 System Maintenance: Starting Xmodem Download Screen.....	35-10
Figure 35-11 Restore Configuration Example	35-11
Figure 35-12 Successful Restoration Confirmation Screen	35-11
Figure 35-13 Telnet Into Menu 24.7.1: Upload System Firmware	35-12
Figure 35-14 Telnet Into Menu 24.7.2: System Maintenance	35-13
Figure 35-15 FTP Session Example of Firmware File Upload.....	35-14
Figure 35-16 Menu 24.7.1 As Seen Using the Console Port.....	35-16
Figure 35-17 Example Xmodem Upload.....	35-17
Figure 35-18 Menu 24.7.2 As Seen Using the Console Port.....	35-18
Figure 35-19 Example Xmodem Upload.....	35-19
Figure 36-1 Command Mode in Menu 24	36-1
Figure 36-2 Valid Commands	36-2
Figure 36-3 Call Control.....	36-3
Figure 36-4 Budget Management	36-4
Figure 36-5 Call History	36-5
Figure 36-6 Menu 24: System Maintenance.....	36-6
Figure 36-7 Menu 24.10 System Maintenance: Time and Date Setting	36-7
Figure 37-1 Menu 24.11 – Remote Management Control	37-2
Figure 38-1 IP Routing Policy Setup	38-2
Figure 38-3 Menu 25.1: Sample IP Routing Policy Setup.....	38-3
Figure 38-4 IP Routing Policy	38-4
Figure 38-5 Menu 3.2: TCP/IP and DHCP Ethernet Setup.....	38-6
Figure 38-6 Example of IP Policy Routing.....	38-7

Figure 38-7 IP Routing Policy Example	38-8
Figure 38-8 IP Routing Policy	38-9
Figure 38-9 Applying IP Policies	38-10
Figure 39-1 Schedule Setup	39-1
Figure 39-2 Schedule Set Setup	39-2
Figure 39-3 Applying Schedule Set(s) to a Remote Node (PPPoE).....	39-4
Figure 39-4 Applying Schedule Set(s) to a Remote Node (PPTP).....	39-5
Figure 40-1 VPN SMT Menu Tree.....	40-1
Figure 40-2 Menu 27: VPN/IPSec Setup	40-2
Figure 40-3 Menu 27.1: IPSec Summary.....	40-2
Figure 40-4 Menu 27.1.1: IPSec Setup	40-6
Figure 40-5 Menu 27.1.1.1: IKE Setup.....	40-12
Figure 40-6 Menu 27.1.1.2: Manual Setup	40-15
Figure 41-1 Menu 27.2: SA Monitor.....	41-1

List of Tables

Table 1-1 Model Specific Features.....	1-7
Table 2-1 Web Configurator Screens Summary.....	2-4
Table 3-1 Ethernet Encapsulation	3-3
Table 3-2 PPPoE Encapsulation.....	3-5
Table 3-3 PPTP Encapsulation.....	3-7
Table 3-4 Private IP Address Ranges	3-8
Table 3-5 Example of Network Properties for LAN Servers with Fixed IP Addresses.....	3-10
Table 3-6 WAN Setup	3-11
Table 4-1 System General Setup.....	4-2
Table 4-2 DDNS.....	4-4
Table 4-3 Password	4-6
Table 4-4 Pre-defined Time Servers.....	4-6
Table 4-5 Time Setting.....	4-8
Table 5-1 IP.....	5-3
Table 5-2 Static DHCP.....	5-6
Table 5-3 IP Alias.....	5-8
Table 6-1 Wireless.....	6-5
Table 6-2 MAC Address Filter.....	6-7
Table 6-3 802.1X Authentication	6-8
Table 7-1 DMZ.....	7-2
Table 8-1 WAN Setup: Route.....	8-2
Table 8-2 Ethernet Encapsulation	8-3
Table 8-3 PPPoE Encapsulation.....	8-5
Table 8-4 PPTP Encapsulation.....	8-7
Table 8-5 IP Setup.....	8-9

Table 8-6 Traffic Redirect.....	8-14
Table 8-7Dial Backup Setup.....	8-17
Table 8-8 Advanced Setup.....	8-22
Table 9-1 NAT Definitions.....	9-1
Table 9-2 NAT Table Example.....	9-2
Table 9-3 NAT Mapping Types.....	9-5
Table 9-4 Services and Port Numbers.....	9-6
Table 9-5 SUA Server.....	9-9
Table 9-6 Address Mapping.....	9-11
Table 9-7 Address Mapping Edit.....	9-12
Table 9-8 Trigger Port.....	9-15
Table 10-1 IP Static Route.....	10-2
Table 10-2 Edit IP Static Route.....	10-3
Table 11-1 Common IP Ports.....	11-4
Table 11-2 ICMP Commands That Trigger Alerts.....	11-6
Table 11-3 Legal NetBIOS Commands.....	11-7
Table 11-4 Legal SMTP Commands.....	11-7
Table 12-1 Application and Subnet-based Bandwidth Management Example.....	12-6
Table 12-2 Firewall Summary.....	12-8
Table 12-3 Firewall Edit Rule.....	12-11
Table 12-4 Source and Destination Addresses Add/Edit.....	12-14
Table 12-5 Custom Port Create/Edit.....	12-15
Table 12-6 BM Global Setting.....	12-16
Table 12-7 Predefined Services.....	12-22
Table 12-8 Attack Alert.....	12-26
Table 13-1 Content Filtering General.....	13-2
Table 13-2 Content Filtering Categories.....	13-8
Table 13-3 Content Filtering Customization.....	13-16

Table 14-1 VPN and NAT	14-5
Table 15-1 AH and ESP	15-2
Table 15-2 VPN Rules	15-4
Table 15-3 Local ID Type and Content Fields	15-9
Table 15-4 Peer ID Type and Content Fields	15-9
Table 15-5 Matching ID Type and Content Configuration Example.....	15-9
Table 15-6 Mismatching ID Type and Content Configuration Example.....	15-10
Table 15-7 VPN IKE.....	15-12
Table 15-8 VPN IKE: Advanced.....	15-22
Table 15-9 VPN Manual Key.....	15-26
Table 15-10 SA Monitor.....	15-30
Table 15-11 Global Setting	15-31
Table 15-12 Telecommuters Sharing One VPN Rule Example.....	15-32
Table 15-13 Telecommuters Using Unique VPN Rules Example.....	15-34
Table 16-1 My Certificates.....	16-4
Table 16-2 My Certificate Import	16-8
Table 16-3 My Certificate Create.....	16-9
Table 16-4 My Certificate Details.....	16-14
Table 16-5 Trusted CAs	16-17
Table 16-6 Trusted CA Details.....	16-21
Table 16-7 Trusted Remote Hosts	16-24
Table 16-8 Trusted Remote Host Import.....	16-27
Table 16-9 Trusted Remote Host Details	16-30
Table 16-10 Directory Servers	16-33
Table 16-11 Directory Server Add	16-34
Table 17-1 Local User Database	17-3
Table 17-2 RADIUS.....	17-6
Table 18-1 WWW	18-4

Table 18-2 SSH.....	18-17
Table 18-3 Telnet	18-22
Table 18-4 FTP	18-23
Table 18-5 SNMP Traps.....	18-25
Table 18-6 SNMP	18-26
Table 18-7 DNS	18-28
Table 18-8 Security.....	18-29
Table 19-1 Configuring UPnP	19-3
Table 19-2 UPnP Ports.....	19-4
Table 20-1 View Log	20-2
Table 20-2 Log Settings Screen.....	20-5
Table 20-3 Reports.....	20-7
Table 20-4 Web Site Hits Report	20-8
Table 20-5 Protocol/ Port Report	20-9
Table 20-6 LAN IP Address Report.....	20-10
Table 20-7 Report Specifications.....	20-11
Table 21-1 System Status.....	21-2
Table 21-2 System Status: Show Statistics	21-3
Table 21-3 DHCP Table.....	21-4
Table 21-4 Restore Configuration.....	21-9
Table 22-1 Main Menu Commands	22-2
Table 22-2 Main Menu Summary	22-4
Table 23-1 General Setup Menu Field.....	23-2
Table 23-2 Configure Dynamic DNS.....	23-3
Table 24-1 MAC Address Cloning in WAN Setup	24-1
Table 24-2 Menu 2: Dial Backup Setup.....	24-3
Table 24-3 Advanced WAN Port Setup: AT Commands Fields	24-4
Table 24-4 Advanced WAN Port Setup: Call Control Parameters	24-5

Table 24-5 Fields in Menu 11.1 Remote Node Profile (Backup ISP)	24-6
Table 24-6 Remote Node PPP Options Menu Fields	24-9
Table 24-7 Remote Node Network Layer Options Menu Fields	24-10
Table 24-8 Menu 11.4: Remote Node Script Menu Fields	24-13
Table 25-1 DHCP Ethernet Setup Menu Fields	25-3
Table 25-2 LAN TCP/IP Setup Menu Fields	25-4
Table 25-3 IP Alias Setup Menu Fields	25-6
Table 25-4 Wireless LAN Setup Menu Fields	25-7
Table 25-5 Menu 3.5.1: WLAN MAC Address Filter	25-10
Table 27-1 Menu 4: Internet Access Setup Menu Fields	27-1
Table 27-2 New Fields in Menu 4 (PPTP) Screen	27-4
Table 27-3 New Fields in Menu 4 (PPPoE) screen	27-5
Table 28-1 Fields in Menu 11.1	28-3
Table 28-2 Fields in Menu 11.1 (PPPoE Encapsulation Specific)	28-6
Table 28-3 Fields in Menu 11.1 (PPTP Encapsulation)	28-7
Table 28-4 Remote Node Network Layer Options Menu Fields	28-8
Table 28-5 Menu 11.1: Remote Node Profile (Traffic Redirect Field)	28-12
Table 28-6 Menu 11.6: Traffic Redirect Setup	28-13
Table 29-1 IP Static Route Menu Fields	29-2
Table 30-1 Applying NAT in Menus 4 & 11.3	30-3
Table 30-2 SUA Address Mapping Rules	30-6
Table 30-3 Fields in Menu 15.1.1	30-7
Table 30-4 Menu 15.1.1.1: Editing/Configuring an Individual Rule in a Set	30-9
Table 30-5 Menu 15.3: Trigger Port Setup Description	30-19
Table 32-1 Abbreviations Used in the Filter Rules Summary Menu	32-5
Table 32-2 Rule Abbreviations Used	32-6
Table 32-3 TCP/IP Filter Rule Menu Fields	32-7
Table 32-4 Generic Filter Rule Menu Fields	32-11

Table 33-1 SNMP Configuration Menu Fields	33-1
Table 33-2 SNMP Traps.....	33-2
Table 34-1 System Maintenance: Status Menu Fields	34-2
Table 34-2 Fields in System Maintenance: Information	34-4
Table 34-3 System Maintenance Menu Syslog Logging	34-8
Table 34-4 System Maintenance Menu Diagnostic	34-13
Table 35-1 Filename Conventions	35-2
Table 35-2 General Commands for GUI-based FTP Clients	35-4
Table 35-3 General Commands for GUI-based TFTP Clients	35-6
Table 36-1 Valid Commands.....	36-2
Table 36-2 Budget Management.....	36-4
Table 36-3 Call History Fields.....	36-5
Table 36-4 Time and Date Setting Fields.....	36-7
Table 37-1 Menu 24.11 – Remote Management Control.....	37-2
Table 38-1 IP Routing Policy Setup.....	38-3
Table 38-2 IP Routing Policy.....	38-4
Table 39-1 Schedule Set Setup Fields.....	39-2
Table 40-1 Menu 27.1: IPSec Summary	40-2
Table 40-2 Menu 27.1.1: IPSec Setup.....	40-6
Table 40-3 Menu 27.1.1.1: IKE Setup	40-13
Table 40-4 Active Protocol: Encapsulation and Security Protocol	40-15
Table 40-5 Menu 27.1.1.2: Manual Setup.....	40-15
Table 41-1 Menu 27.2: SA Monitor	41-2

Preface

About This User's Manual

Congratulations on your purchase of the ZyWALL Internet Security Gateway. This manual is designed to guide you through the configuration of your ZyWALL for its various applications.

Use the web configurator, System Management Terminal (SMT) or command interpreter interface to configure your ZyWALL. Not all features can be configured through all interfaces.

The web configurator parts of this guide contain background information on features configurable by the web configurator and the SMT. The SMT parts of this guide contain background information solely on features not configurable by the web configurator.

This manual may refer to the ZyWALL Internet Security Gateway as the ZyWALL.

This manual covers the ZyWALL 10W, 30W, 50 and 100 models. Supported features and the details of the features, vary from model to model. Not every feature applies to every model; refer to *Table 1:1 Model Specific Features* to see what features are specific to your ZyWALL model.

Related Documentation

- Support Disk
Refer to the included CD for support documents.
- Read Me First or Quick Start Guide
The Read Me First or Quick Start Guide is designed to help you get up and running right away. It contains a detailed easy-to-follow connection diagram, default settings, handy checklists and information on setting up your network and configuring for Internet access.
- Web Configurator Online Help
Embedded web help for descriptions of individual screens and supplementary information.
- Packing List Card
The Packing List Card lists all items that should have come in the package.
- Certifications
Refer to the product page at www.zyxel.com for information on product certifications.
- ZyXEL Glossary and Web Site
Please refer to www.zyxel.com for an online glossary of networking terms and additional support documentation.











User's Guide Feedback

Help us help you. E-mail all User's Guide-related comments, questions or suggestions for improvement to techwriters@zyxel.com.tw or send regular mail to The Technical Writing Team, ZyXEL Communications Corp., 6 Innovation Road II, Science-Based Industrial Park, Hsinchu, 300, Taiwan. Thank you.

Syntax Conventions

- The version number on the title page is the latest firmware version that is documented in this *User's Guide*. Earlier versions may also be included.
- “Enter” means for you to type one or more characters and press the carriage return. “Select” or “Choose” means for you to use one of the predefined choices.
- The SMT menu titles and labels are in **Bold Times New Roman** font. Command and arrow keys are enclosed in square brackets. [ENTER] means the Enter, or carriage return key; [ESC] means the Escape key and [SPACE BAR] means the Space Bar.
- The choices of a menu item are in **Bold Arial** font.
- Mouse action sequences are denoted using a comma. For example, “click the Apple icon, **Control Panels** and **Modem**” means first click the Apple icon, then point your mouse pointer to **Control Panels** and then click **Modem**.
- For brevity's sake, we will use “e.g.” as a shorthand for “for instance” and “i.e.” for “that is” or “in other words” throughout this manual.

Graphics Icons Key

 ZyWALL	 Computer	 Notebook Computer
 Server	 Modem	 DSLAM (Digital Subscriber Line Access Multiplexer)
 Firewall	 Router	 Switch
 Wireless Signal		

Part I:

Getting Started

This part helps you get to know your ZyWALL, introduces the web configurator and covers how to configure the Wizard Setup screens.

Chapter 1

Getting to Know Your ZyWALL

This chapter introduces the main features and applications of the ZyWALL.

1.1 ZyWALL Internet Security Gateway Overview

The ZyWALL is the ideal secure gateways for all data passing between the Internet and the LAN. By integrating NAT, firewall and VPN capability, ZyXEL's ZyWALL is a complete security solution that protects your Intranet and efficiently manages data traffic on your network. The embedded web configurator is easy to operate.

1.1.1 ZyWALL 10W Internet Security Gateway

The ZyWALL 10W is wireless ready; thus giving you the option of adding a wireless LAN to your home or small business network.

1.1.2 ZyWALL 30W Internet Security Gateway

The ZyWALL 30W adds more firewall protection and gives you the option of adding a wireless LAN to your small office or home office.

1.1.3 ZyWALL 50 Internet Security Gateway for Small/Home Office and Small Businesses

The ZyWALL 50 adds more processing power to provide the robust firewall protection necessary for small to medium businesses to handle e-business.

1.1.4 ZyWALL 100 Internet Security Gateway for Small to Medium Businesses

The ZyWALL 100 offers the highest degree of functionality and security for business applications. It supports up to 100 IPSec VPN connections and increases network security by adding a De-Militarized Zone (DMZ) port for use with publicly accessible servers.

1.2 ZyWALL Features

The following sections describe ZyWALL features. Features vary by ZyWALL model.

1.2.1 Physical Features

Auto-negotiating 10/100 Mbps Ethernet LAN

The LAN interface automatically detects if it's on a 10 or a 100 Mbps Ethernet.

Auto-crossover 10/100 Mbps Ethernet LAN

The LAN interface automatically adjusts to either a crossover or straight-through Ethernet cable. This feature is not available on all models.

Auto-negotiating 10/100 Mbps Ethernet DMZ

Public servers (Web, FTP, etc.) attached to the DeMilitarized Zone (DMZ) port are visible to the outside world (while still being protected from DoS (Denial of Service) attacks such as SYN flooding and Ping of Death) and can also be accessed from the secure LAN. This feature is not available on all models.

Auto-negotiating 10/100 Mbps Ethernet WAN

The 10/100 Mbps Ethernet WAN port attaches to the Internet via broadband modem or router.

Backup WAN or Auxiliary

The Dial Backup or Auxiliary port can be used in reserve as a traditional dial-up connection when/if ever the broadband connection to the WAN port fails. This feature is not available on all models.

Time and Date

The ZyWALL allows you to get the current time and date from an external server when you turn on your ZyWALL. You can also set the time manually. The Real Time Chip (RTC) keeps track of the time and date.

Reset Button

The ZyWALL reset button is built into the rear panel. Use this button to restore the factory default password to 1234; IP address to 192.168.1.1, subnet mask to 255.255.255.0 and DHCP server enabled with a pool of 32 IP addresses starting at 192.168.1.33.

PCMCIA Port

The PCMCIA port provides the option of a wireless LAN. This feature is not available on all models.

IEEE 802.11b 11 Mbps Wireless LAN

The optional 11 Mbps wireless LAN card provides mobility and a fast network environment for small and home offices. Users can connect to the local area network without any wiring efforts and enjoy reliable high-speed connectivity. This feature is not available on all models.

1.2.2 Non-Physical Features

Bandwidth Management Lite

Bandwidth management lite allows you to use firewall rules to perform basic bandwidth management. Bandwidth management allows you to allocate network resources according to defined policies. This policy-based bandwidth allocation helps your network to better handle real-time applications such as Voice-over-IP (VoIP).

IPSec VPN Capability

Establish a Virtual Private Network (VPN) to connect with business partners and branch offices using data encryption and the Internet to provide secure communications without the expense of leased site-to-site lines. The ZyWALL VPN is based on the IPSec standard and is fully interoperable with other IPSec-based VPN products.

X-Auth (Extended Authentication)

X-Auth provides added security for VPN by requiring each VPN client to use a username and password.

Certificates

The ZyWALL can use certificates (also called digital IDs) to authenticate users. Certificates are based on public-private key pairs. Certificates provide a way to exchange public keys for use in authentication.

SSH

The ZyWALL uses the SSH (Secure Shell) secure communication protocol to provide secure encrypted communication between two hosts over an unsecured network.

HTTPS

HyperText Transfer Protocol over Secure Socket Layer, or HTTP over SSL is a web protocol that encrypts and decrypts web sessions. Use HTTPS for secure web configurator access to the ZyWALL.

Firewall

The ZyWALL is a stateful inspection firewall with DoS (Denial of Service) protection. By default, when the firewall is activated, all incoming traffic from the WAN to the LAN is blocked unless it is initiated from the LAN. The ZyWALL firewall supports TCP/UDP inspection, DoS detection and prevention, real time alerts, reports and logs.

Content Filtering

The ZyWALL can block web features such as ActiveX controls, Java applets and cookies, as well as disable web proxies. The ZyWALL can block or allow access to web sites that you specify. The ZyWALL can also block access to web sites containing keywords that you specify. You can define time periods and days during which content filtering is enabled and include or exclude a range of users on the LAN from content filtering.

You can also subscribe to category-based content filtering that allows your ZyWALL to check web sites against an external database of dynamically updated ratings of millions of web sites.

RADIUS (RFC2138, 2139)

RADIUS (Remote Authentication Dial In User Service) server enables authentication, authorization and accounting for your wireless network. This feature is not available on all models.

IEEE 802.1x for Network Security

The ZyWALL supports the IEEE 802.1x standard that works with the IEEE 802.11 to enhance user authentication. With the local user profile, the ZyWALL allows you to configure up to 32 user profiles without a network authentication server. In addition, centralized user and accounting management is possible on an optional network authentication server. This feature is not available on all models.

Wireless LAN MAC Address Filtering

Your ZyWALL can check the MAC addresses of wireless stations against a list of allowed or denied MAC addresses.

WEP Encryption

WEP (Wired Equivalent Privacy) encrypts data frames before transmitting over the wireless network to help keep network communications private.

Brute-Force Password Guessing Protection

The ZyWALL has a special protection mechanism to discourage brute-force password guessing attacks on the ZyWALL's management interfaces. You can specify a wait-time that must expire before entering a fourth password after three incorrect passwords have been entered. Please see the appendices for details about this feature.¹

Packet Filtering

The packet filtering mechanism blocks unwanted traffic from entering/leaving your network.

Universal Plug and Play (UPnP)

Using the standard TCP/IP protocol, the ZyWALL and other UPnP enabled devices can dynamically join a network, obtain an IP address and convey its capabilities to other devices on the network. This feature is not available on all models.

Call Scheduling

Configure call time periods to restrict and allow access for users on remote nodes.

¹ Brute Force Password Protection was not available on every model at the time of writing.

PPPoE

PPPoE facilitates the interaction of a host with an Internet modem to achieve access to high-speed data networks via a familiar "dial-up networking" user interface.

PPTP Encapsulation

Point-to-Point Tunneling Protocol (PPTP) is a network protocol that enables secure transfer of data from a remote client to a private server, creating a Virtual Private Network (VPN) using a TCP/IP-based network. PPTP supports on-demand, multi-protocol and virtual private networking over public networks, such as the Internet. The ZyWALL supports one PPTP server connection at any given time.

Dynamic DNS Support

With Dynamic DNS (Domain Name System) support, you can have a static hostname alias for a dynamic IP address, allowing the host to be more easily accessible from various locations on the Internet. You must register for this service with a Dynamic DNS service provider.

IP Multicast

Deliver IP packets to a specific group of hosts using IP multicast. IGMP (Internet Group Management Protocol) is the protocol used to support multicast groups. The latest version is version 2 (see RFC 2236); the ZyWALL supports both versions 1 and 2.

IP Alias

IP Alias allows you to partition a physical network into logical networks over the same Ethernet interface. The ZyWALL supports three logical LAN interfaces via its single physical Ethernet LAN interface with the ZyWALL itself as the gateway for each LAN network.

IP Policy Routing

IP Policy Routing provides a mechanism to override the default routing behavior and alter packet forwarding based on the policies defined by the network administrator. This feature is not available on all models.

Central Network Management

Central Network Management (CNM) allows an enterprise or service provider network administrator to manage your ZyWALL. The enterprise or service provider network administrator can configure your ZyWALL, perform firmware upgrades and do troubleshooting for you.

SNMP

SNMP (Simple Network Management Protocol) is a protocol used for exchanging management information between network devices. SNMP is a member of the TCP/IP protocol suite. Your ZyWALL supports SNMP agent functionality, which allows a manager station to manage and monitor the ZyWALL through the network. The ZyWALL supports SNMP version one (SNMPv1).

Network Address Translation (NAT)

Network Address Translation (NAT) allows the translation of an Internet protocol address used within one network (for example a private IP address used in a local network) to a different IP address known within another network (for example a public IP address used on the Internet).

Traffic Redirect

Traffic Redirect forwards WAN traffic to a backup gateway on the LAN when the ZyWALL cannot connect to the Internet, thus acting as an auxiliary backup when your regular WAN connection fails.

Port Forwarding

Use this feature to forward incoming service requests to a server on your local network. You may enter a single port number or a range of port numbers to be forwarded, and the local IP address of the desired server.

DHCP (Dynamic Host Configuration Protocol)

DHCP (Dynamic Host Configuration Protocol) allows the individual client computers to obtain the TCP/IP configuration at start-up from a centralized DHCP server. The ZyWALL has built-in DHCP server capability, enabled by default, which means it can assign IP addresses, an IP default gateway and DNS servers to all systems that support the DHCP client. The ZyWALL can also act as a surrogate DHCP server (**DHCP Relay**) where it relays IP address assignment from the actual real DHCP server to the clients.

Full Network Management

The embedded web configurator is an all-platform web-based utility that allows you to easily access the ZyWALL's management settings and configure the firewall. Most functions of the ZyWALL are also software configurable via the SMT (System Management Terminal) interface. The SMT is a menu-driven interface that you can access from a terminal emulator through the console port or over a telnet connection.

RoadRunner Support

In addition to standard cable modem services, the ZyWALL supports Time Warner's RoadRunner Service.

Logging and Tracing

- ◆ Built-in message logging and packet tracing.
- ◆ Unix syslog facility support.
- ◆ Firewall logs.
- ◆ Content filtering logs.

Upgrade ZyWALL Firmware via LAN

The firmware of the ZyWALL can be upgraded via the LAN.

Embedded FTP and TFTP Servers

The ZyWALL's embedded FTP and TFTP Servers enable fast firmware upgrades as well as configuration file backups and restoration.

1.2.3 Model Specific Features

This table lists the differences between models; it does not include features that are common to all of the ZyWALL models documented in this user's guide.

Table 1-1 Model Specific Features

ZYWALL MODEL	100	50	30W	10W
FEATURES				
Firmware Version Number	3.52	3.52	3.62	3.62
Dial Backup (or Auxiliary)	O		*	*
System DNS			O	O
PCMCIA Slot	O		O	O
PCMCIA Card Release Button			O	O
802.11b Wireless LAN Support	O		O	O
802.1x Wireless LAN Support	O		O	O
EAP-TLS and EAP-TTLS			O	O
Auto-crossover 10/100 Mbps Ethernet LAN	**		O	O
Auto-negotiating 10/100 Mbps Ethernet DMZ	O			
Uplink Button	**	O		
Power Switch	O			
Bandwidth Management Lite			O	O
IP Policy Routing	O			
Number of Static Routes	50	30	30	12
Number of Firewall Rules ***	400	100	100	50
Number of Custom Ports for Firewall Rules	50	30	50	50
Number of Simultaneously Usable IPSec VPN Security Associations	100	50	30	10
Number of Configurable IPSec VPN Security Associations	120	60	30	10
Certificates			O	O
X-Auth (Extended Authentication)			O	O
AES (Advanced Encryption Standard)			O	O

Table 1-1 Model Specific Features

ZYWALL MODEL	100	50	30W	10W
FEATURES				
SSH			O	O
HTTPS			O	O
UPnP			O	O
UPnP Ports Table			O	O
System DNS Server Settings			O	O
Trigger Port Forwarding	O		O	O
Reports	O		O	O
DHCP Address Reserve	O		O	O

Table Key:

An “O” in a model’s column shows that the model has the specified feature

* The ZyWALL 10W and 30W use the same port for console management and for an auxiliary (backup) WAN connection.

** The latest ZyWALL 100 hardware has an auto-crossover 10/100 Mbps Ethernet LAN port and no Uplink button. Earlier ZyWALL 100 hardware versions had a 10/100 Mbps Ethernet LAN port and an Uplink button.

*** The numbers of firewall rules per ZyWALL model show here are estimated. The actual number of rules that you can configure depends on how much memory each firewall rule takes up.

1.2.4 ZyWALL 100 Note

The ZyWALL 100 is designed to act as a secure gateway for all data passing between the Internet and the LAN or the DMZ. It has three Ethernet ports, one RS-232 auxiliary port and one PCMCIA port (for optional wireless applications), which are used to physically separate the network into three areas.

I. LAN Network (a trusted network)

- LAN port: The auto-negotiating 10/100 Mbps Ethernet LAN interface automatically detects if it’s on a 10 or a 100 Mbps Ethernet. Attach computers that are to be secured from the outside world to this port. These computers will have access to e-mail, FTP and the World Wide Web but incoming connections (from the Internet) are only allowed if the connection is originally initiated from the LAN computer or a firewall rule has been specifically configured to allow access.

II. DMZ Network

- DMZ port: Attach public servers (Web, FTP, etc.) to the DeMilitarized Zone (DMZ) port. Computers attached to this port are visible to the outside world (while still being protected from DoS (Denial of Service) attacks such as SYN flooding and Ping of Death) and can also be accessed from the secure LAN.

III. WAN Network

- WAN port: The 10/100 Mbps Ethernet WAN port attaches to the Internet via broadband modem or router.
- Dial Backup port: This auxiliary port can be used as a backup line when/if the broadband connection to the WAN port fails.

1.3 Applications for the ZyWALL

Here are some examples of what you can do with your ZyWALL.

1.3.1 Secure Broadband Internet Access via Cable or DSL Modem

You can connect a cable modem, DSL or wireless modem to the ZyWALL for broadband Internet access via Ethernet or wireless port on the modem. The ZyWALL guarantees not only high speed Internet access, but secure internal network protection and traffic management as well.

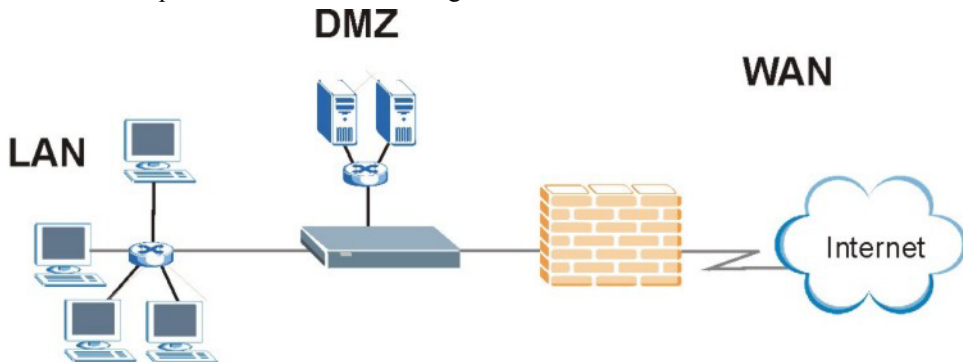

Figure 1-1 Secure Internet Access via Cable, DSL or Wireless Modem

1.3.2 VPN Application

ZyWALL VPN is an ideal cost-effective way to connect branch offices and business partners over the Internet without the need (and expense) for leased lines between sites.

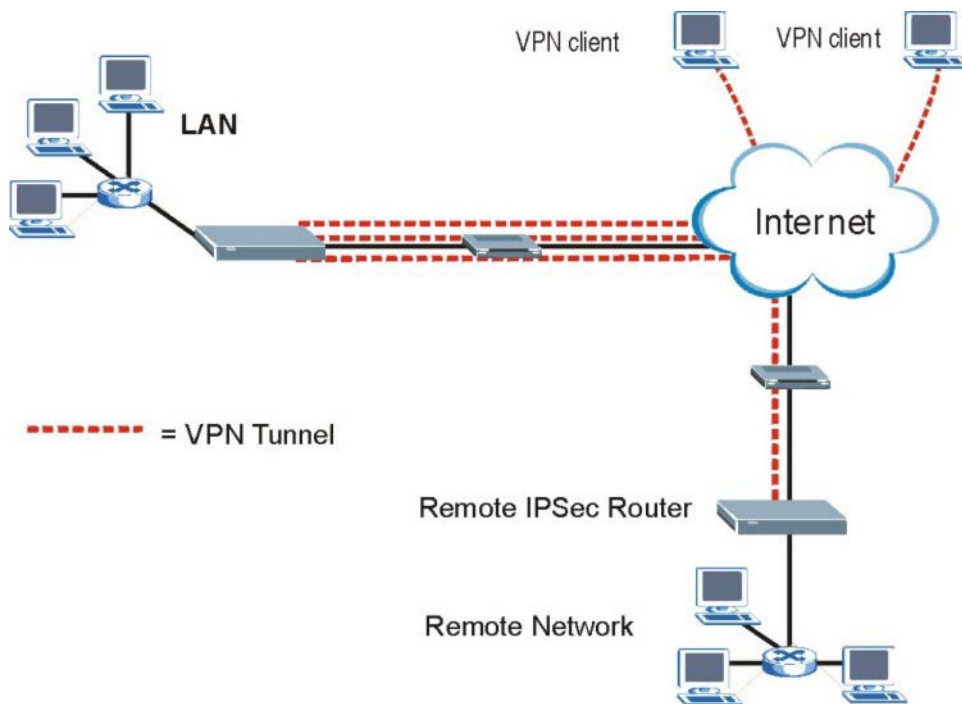

Figure 1-2 VPN Application

Chapter 2

Introducing the Web Configurator

This chapter describes how to access the ZyWALL web configurator and provides an overview of its screens.

2.1 Web Configurator Overview

The embedded web configurator allows you to manage the ZyWALL from anywhere through a browser such as Microsoft Internet Explorer or Netscape Navigator. Use Internet Explorer 6.0 and later or Netscape Navigator 7.0 and later versions with JavaScript enabled.

It is recommended that you set your screen resolution to 1024 by 768 pixels. The screens you see in the web configurator may vary somewhat from the ones shown in this document due to differences between individual ZyWALL models or firmware versions. The screens shown come primarily from the ZyWALL 10W. Screens specific to other models have the model listed in the caption.

2.2 Accessing the ZyWALL Web Configurator

- Step 1.** Make sure your ZyWALL hardware is properly connected and prepare your computer/computer network to connect to the ZyWALL (refer to the *Quick Start Guide*).
- Step 2.** Launch your web browser.
- Step 3.** Type "192.168.1.1" as the URL.
- Step 4.** Type "1234" (default) as the password and click **Login**. In some versions, the default password appears automatically - if this is the case, click **Login**.
- Step 5.** You should see a screen asking you to change your password (highly recommended) as shown next. Type a new password (and retype it to confirm) and click **Apply** or click **Ignore**.

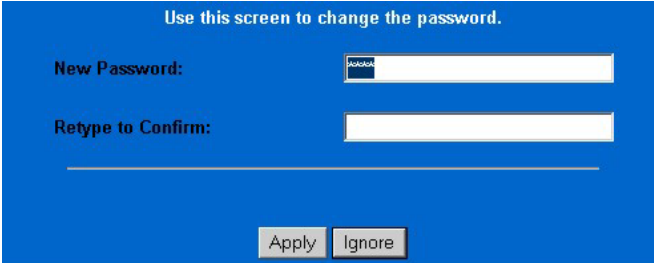

Use this screen to change the password.

New Password:

Retype to Confirm:

Figure 2-1 Change Password Screen

- Step 6.** Click **Apply** in the **Replace Certificate** screen to create a certificate using your ZyWALL's MAC address that will be specific to this device.

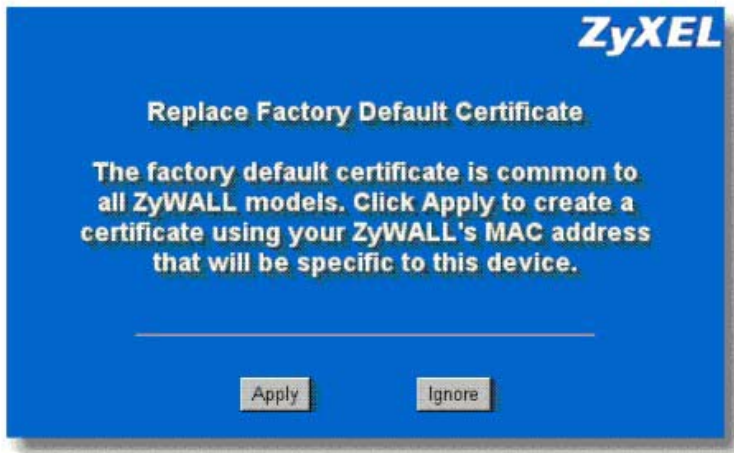

Figure 2-2 Replace Certificate Screen

- Step 7.** You should now see the **MAIN MENU** screen (see *Figure 2-4*).

The management session automatically times out when the time period set in the Administrator Inactivity Timer field expires (default five minutes). Simply log back into the ZyWALL if this happens to you.

2.3 Resetting the ZyWALL

If you forget your password or cannot access the web configurator, you will need to reload the factory-default configuration file or use the **RESET** button the back of the ZyWALL. Uploading this configuration file replaces the current configuration file with the factory-default configuration file. This means that you will lose all configurations that you had previously and the speed of the console port will be reset to the default of 9600bps with 8 data bit, no parity, one stop bit and flow control set to none. The password will be reset to “1234”, also.

2.3.1 Procedure To Use The Reset Button

Make sure the **SYS LED** is on (not blinking) before you begin this procedure.

- Step 1.** Press the **RESET** button for ten seconds, and then release it. If the **SYS LED** begins to blink, the defaults have been restored and the ZyWALL restarts. Otherwise, go to step 2.

- Step 2.** Turn the ZyWALL off.
- Step 3.** While pressing the **RESET** button, turn the ZyWALL on.
- Step 4.** Continue to hold the **RESET** button. The **SYS** LED will begin to blink and flicker very quickly after about 10 or 15 seconds. This indicates that the defaults have been restored and the ZyWALL is now restarting.
- Step 5.** Release the **RESET** button and wait for the ZyWALL to finish restarting.

2.3.2 Uploading a Configuration File Via Console Port

- Step 1.** Download the default configuration file from the ZyXEL FTP site, unzip it and save it in a folder.
- Step 2.** Turn off the ZyWALL, begin a terminal emulation software session and turn on the ZyWALL again. When you see the message "Press Any key to enter Debug Mode within 3 seconds", press any key to enter debug mode.
- Step 3.** Enter "y" at the prompt below to go into debug mode.
- Step 4.** Enter "atlc" after "Enter Debug Mode" message.
- Step 5.** Wait for "Starting XMODEM upload" message before activating Xmodem upload on your terminal. This is an example Xmodem configuration upload using HyperTerminal.
- Step 6.** Click **Transfer**, then **Send File** to display the following screen.

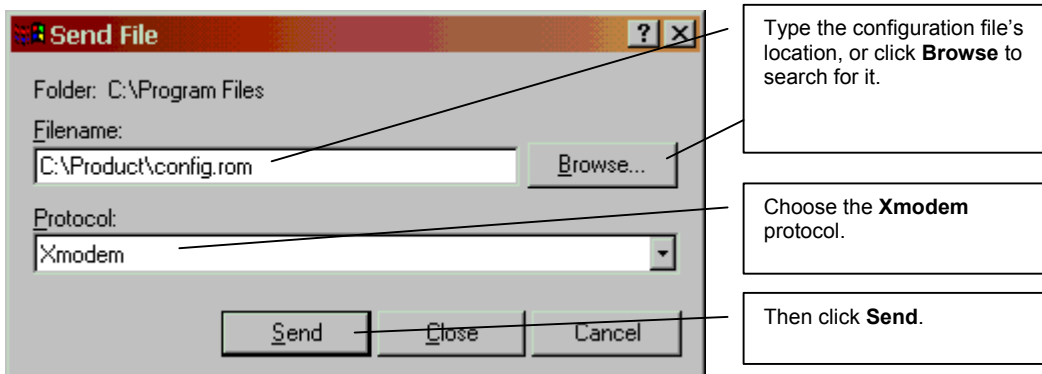

Figure 2-3 Example Xmodem Upload

- Step 7.** After successful firmware upload, enter "atgo" to restart the router.

2.4 Navigating the ZyWALL Web Configurator

The following summarizes how to navigate the web configurator from the **MAIN MENU** screen.

Follow the instructions you see in the **MAIN MENU** screen or click the  icon (located in the top right corner of most screens) to view online help.

The  icon does not appear in the **MAIN MENU** screen.

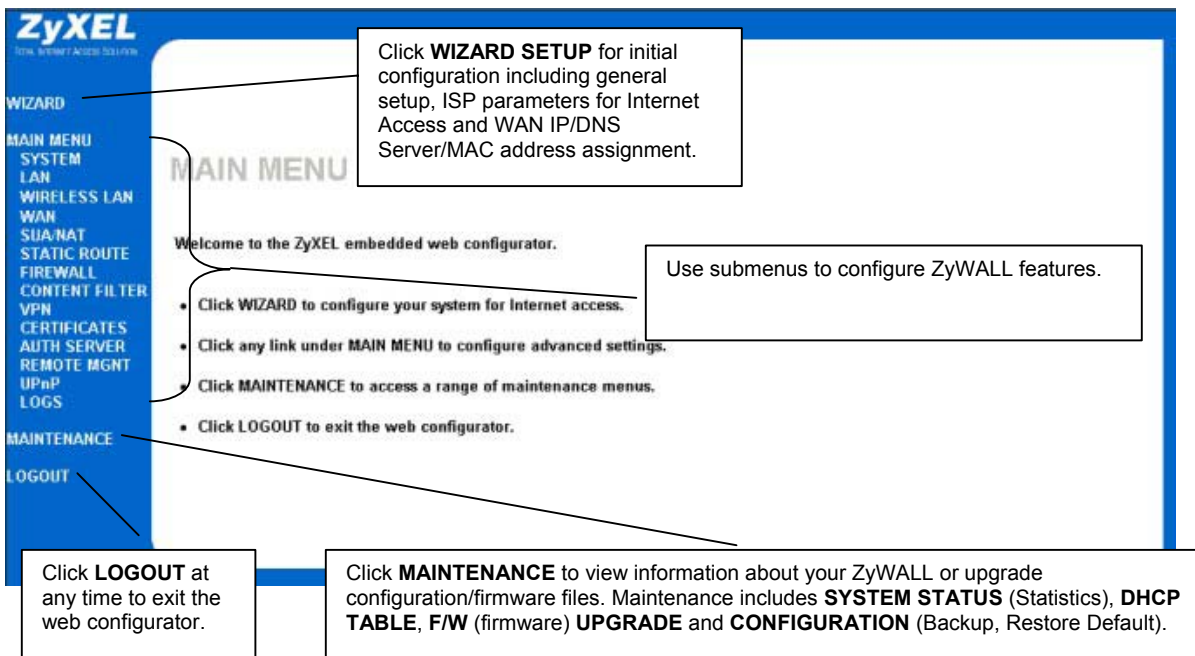

Figure 2-4 Web Configurator MAIN MENU Screen

The following table describes the sub-menus.

Table 2-1Web Configurator Screens Summary

LINK	TAB	FUNCTION
WIZARD		Use these screens for initial configuration including general setup, ISP parameters for Internet Access and WAN IP/DNS Server/MAC address assignment.
SYSTEM	General	Use this screen to configure general system settings.

Table 2-1 Web Configurator Screens Summary

LINK	TAB	FUNCTION
	DDNS	Use this screen to configure Dynamic Domain Name System settings.
	Password	Use this screen to change your password.
	Time Setting	Use this screen to change your ZyWALL's time and date.
LAN	IP	Use this screen to configure LAN DHCP and TCP/IP settings.
	Static DHCP	Use this screen to assign fixed IP addresses on the LAN.
	IP Alias	Use this screen to partition your LAN interface into subnets.
WIRELESS LAN	Wireless	Use this screen to configure the wireless LAN settings.
	MAC Filter	Use this screen to change MAC filter settings on the ZyWALL.
	802.1X	Use this screen to configure the ZyWALL's WLAN authentication settings.
DMZ	DMZ	Use this screen to configure your DMZ connection.
WAN	Route	This screen allows you to configure route priority and traffic redirect properties.
	WAN ISP	Use this screen to configure Internet Service Provider parameters.
	WAN IP	Use this screen to configure WAN IP address settings.
	WAN MAC	Use this screen to configure WAN MAC address settings.
	Traffic Redirect	Use this screen to configure your traffic redirect properties and parameters.
	Dial Backup	Use this screen to configure the backup WAN dial-up connection.
SUA/NAT	SUA Server	Use this screen to configure servers behind the ZyWALL.
	Address Mapping	Use this screen to configure network address translation mapping rules.
	Trigger Port	Use this screen to change your ZyWALL's trigger port settings.
STATIC ROUTE	IP Static Route	Use this screen to configure IP static routes.
FIREWALL	Summary	This screen shows a summary of the firewall rules, and allows you to edit/add firewall rules.
	Attack Alert	Use this screen to configure the threshold for DoS attacks.

Table 2-1 Web Configurator Screens Summary

LINK	TAB	FUNCTION
	BM Global Setting	Use this screen to enable bandwidth management (lite) and set a speed for the WAN port.
CONTENT FILTER	General	This screen allows you to enable content filtering and block certain web features.
	Categories	Use this screen to select which categories of web pages to filter out, as well as to register for external database content filtering and view reports.
	Customization	Use this screen to customize the content filter list.
VPN	VPN Rules	Use this screen to configure VPN connections and view the rule summary.
	SA Monitor	Use this screen to display and manage active VPN connections.
	Global Setting	Use this screen to allow NetBIOS packets through the VPN connections.
CERTIFICATES	My Certificates	Use this screen to view a summary list of certificates and manage certificates and certification requests.
	Trusted CAs	Use this screen to view and manage the list of the trusted certification authorities.
	Trusted Remote Hosts	Use this screen to view and manage the certificates belonging to the trusted remote hosts.
	Directory Servers	Use this screen to view and manage the list of the directory servers.
AUTH SERVER	Local User Database	Use this screen to configure the local user account(s) on the ZyWALL.
	RADIUS	Configure this screen to use an external server to authenticate wireless and/or VPN users.
REMOTE MGMT	WWW	Use this screen to configure through which interface(s) and from which IP address(es) users can use HTTPS or HTTP to manage the ZyWALL.
	SSH	Use this screen to configure through which interface(s) and from which IP address(es) users can use Secure Shell to manage the ZyWALL.
	TELNET	Use this screen to configure through which interface(s) and from which IP address(es) users can use Telnet to manage the ZyWALL.

Table 2-1 Web Configurator Screens Summary

LINK	TAB	FUNCTION
	FTP	Use this screen to configure through which interface(s) and from which IP address(es) users can use FTP to access the ZyWALL.
	SNMP	Use this screen to configure your ZyWALL's settings for Simple Network Management Protocol management.
	DNS	Use this screen to configure through which interface(s) and from which IP address(es) users can send DNS queries to the ZyWALL.
	Security	Use this screen to set whether or not the ZyWALL responds to ICMP pings and/or requests for unauthorized services.
UPnP	UPnP	Use this screen to enable UPnP on the ZyWALL.
	Ports	Use this screen to view the NAT port mapping rules that UPnP creates on the ZyWALL.
LOGS	View Log	Use this screen to view the logs for the categories that you selected.
	Log Settings	Use this screen to change your ZyWALL's log settings.
	Reports	Use this screen to have the ZyWALL record and display the network usage reports.
MAINTENANCE	General	This screen contains administrative and system-related information.
	DHCP Table	This screen shows current DHCP client information on all network clients using the DHCP server.
	F/W Upload	Use this screen to upload firmware to your ZyWALL.
	Configuration	Use this screen to backup and restore the configuration or reset the factory defaults to your ZyWALL.
	Restart	This screen allows you to reboot the ZyWALL without turning the power off.
LOGOUT		Click this label to exit the web configurator.

Chapter 3

Wizard Setup

This chapter provides information on the Wizard Setup screens in the web configurator.

3.1 Wizard Setup Overview

The web configurator's setup wizard helps you configure your device to access the Internet. The second screen has three variations depending on what encapsulation type you use. Refer to your ISP checklist in the *Quick Start Guide* to know what to enter in each field. Leave a field blank if you don't have that information.

3.2 Wizard Setup: General Setup and System Name

General Setup contains administrative and system-related information. **System Name** is for identification purposes. However, because some ISPs check this name you should enter your computer's "Computer Name".

- In Windows 95/98 click **Start, Settings, Control Panel, Network**. Click the Identification tab, note the entry for the **Computer Name** field and enter it as the **System Name**.
- In Windows 2000, click **Start, Settings and Control Panel** and then double-click **System**. Click the **Network Identification** tab and then the **Properties** button. Note the entry for the **Computer name** field and enter it as the **System Name**.
- In Windows XP, click **Start, My Computer, View system information** and then click the **Computer Name** tab. Note the entry in the **Full computer name** field and enter it as the ZyWALL **System Name**.

3.2.1 Domain Name

The **Domain Name** entry is what is propagated to the DHCP clients on the LAN. If you leave this blank, the domain name obtained by DHCP from the ISP is used. While you must enter the host name (System Name) on each individual computer, the domain name can be assigned from the ZyWALL via DHCP. Click **Next** to configure the ZyWALL for Internet access.

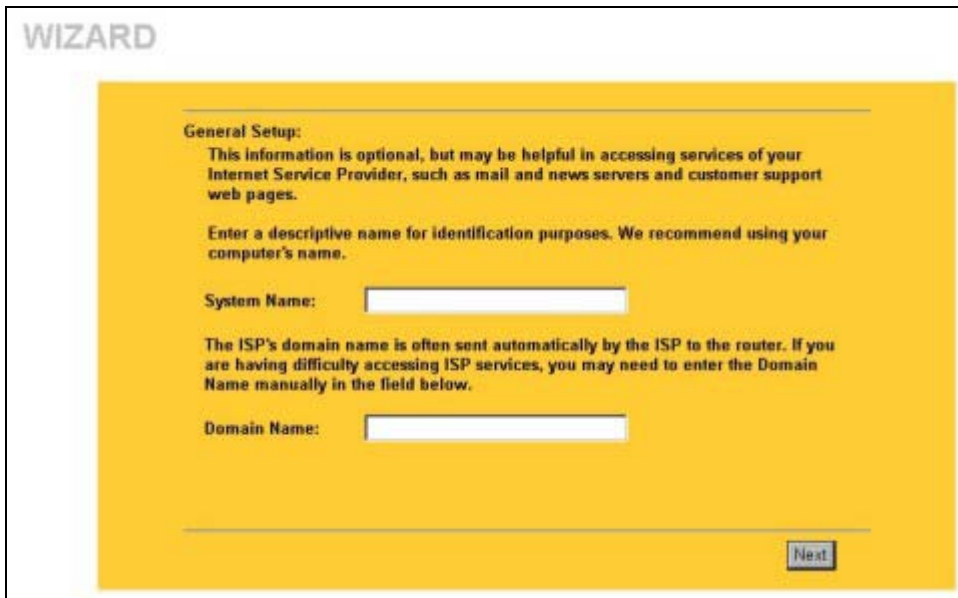

Figure 3-1 Wizard 1

3.3 Wizard Setup: Screen 2

The ZyWALL offers three choices of encapsulation. They are **Ethernet**, **PPTP** or **PPPoE**.

3.3.1 Ethernet

Choose **Ethernet** when the WAN port is used as a regular Ethernet.

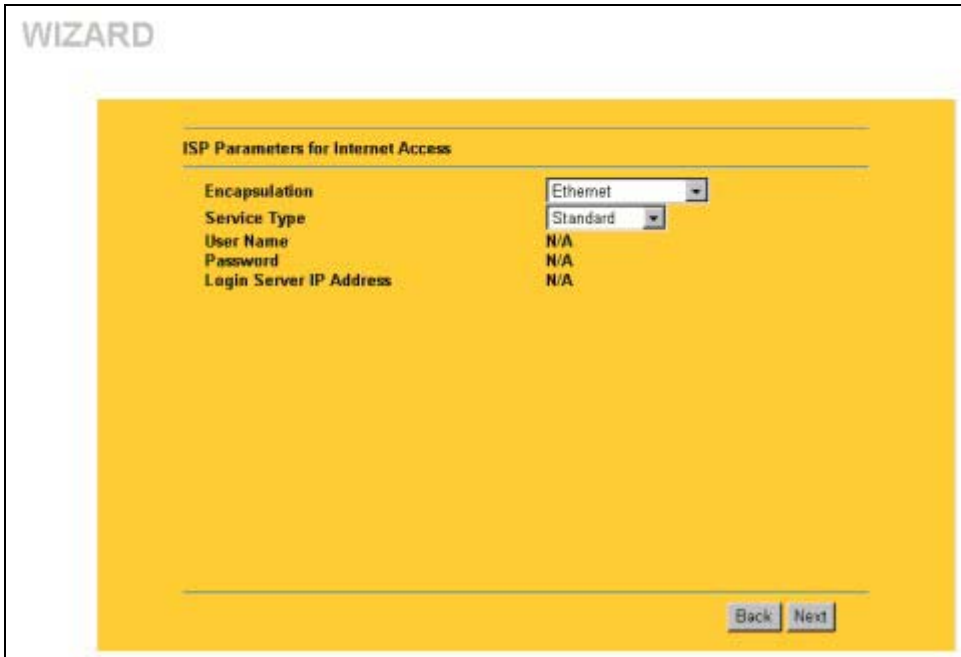

Figure 3-2 Wizard 2: Ethernet Encapsulation

The following table describes the fields in this screen.

Table 3-1 Ethernet Encapsulation

LABEL	DESCRIPTION
ISP Parameters for Internet Access	
Encapsulation	You must choose the Ethernet option when the WAN port is used as a regular Ethernet. Otherwise, choose PPPoE or PPTP for a dial-up connection.
Service Type	Choose from Standard , Telstra (RoadRunner Telstra authentication method), RR-Manager (Roadrunner Manager authentication method), RR-Toshiba (Roadrunner Toshiba authentication method) or Telia Login . The following fields are not applicable (N/A) for the Standard service type.
User Name	Type the user name given to you by your ISP.
Password	Type the password associated with the user name above.
Login Server IP Address	Type the authentication server IP address here if your ISP gave you one.

Table 3-1 Ethernet Encapsulation

LABEL	DESCRIPTION
Login Server	This field only applies when you select Telia Login in the Service Type field. Type the domain name of the Telia login server, for example "login1.telia.com".
Relogin Period (min)	This field only applies when you select Telia Login in the Service Type field. The Telia server logs the ZyWALL out if the ZyWALL does not log in periodically. Type the number of minutes from 1 to 59 (30 default) for the ZyWALL to wait between logins.
Next	Click Next to continue.
Back	Click Back to return to the previous screen.

3.3.2 PPPoE Encapsulation

Point-to-Point Protocol over Ethernet (PPPoE) functions as a dial-up connection. PPPoE is an IETF (Internet Engineering Task Force) draft standard specifying how a host personal computer interacts with a broadband modem (for example DSL, cable, wireless, etc.) to achieve access to high-speed data networks. It preserves the existing Microsoft Dial-Up Networking experience and requires no new learning or procedures.

For the service provider, PPPoE offers an access and authentication method that works with existing access control systems (for instance, Radius). For the user, PPPoE provides a login and authentication method that the existing Microsoft Dial-Up Networking software can activate, and therefore requires no new learning or procedures for Windows users.

One of the benefits of PPPoE is the ability to let end users access one of multiple network services, a function known as dynamic service selection. This enables the service provider to easily create and offer new IP services for specific users.

Operationally, PPPoE saves significant effort for both the subscriber and the ISP/carrier, as it requires no specific configuration of the broadband modem at the subscriber's site.

By implementing PPPoE directly on the ZyWALL (rather than individual computers), the computers on the LAN do not need PPPoE software installed, since the ZyWALL does that part of the task. Furthermore, with NAT, all of the LAN's computers will have Internet access.

Refer to the *Appendices* for more information on PPPoE.

Figure 3-3 Wizard2: PPPoE Encapsulation

The following table describes the fields in this screen.

Table 3-2 PPPoE Encapsulation

LABEL	DESCRIPTION
ISP Parameter for Internet Access	
Encapsulation	Choose an encapsulation method from the pull-down list box. PPPoE forms a dial-up connection.
Service Name	Type the name of your service provider.
User Name	Type the user name given to you by your ISP.
Password	Type the password associated with the user name above.
Nailed-Up Connection	Select Nailed-Up Connection if you do not want the connection to time out.
Idle Timeout	Type the time in seconds that elapses before the router automatically disconnects from the PPPoE server. The default time is 100 seconds.

Table 3-2 PPPoE Encapsulation

LABEL	DESCRIPTION
Next	Click Next to continue.
Back	Click Back to return to the previous screen.

3.3.3 PPTP Encapsulation

Point-to-Point Tunneling Protocol (PPTP) is a network protocol that enables transfers of data from a remote client to a private server, creating a Virtual Private Network (VPN) using TCP/IP-based networks.

PPTP supports on-demand, multi-protocol, and virtual private networking over public networks, such as the Internet.

Refer to the *Appendices* for more information on PPTP.

The ZYWALL supports one PPTP server connection at any given time.

WIZARD

ISP Parameters for Internet Access

Encapsulation: PPTP

User Name: _____

Password: _____

Nailed-Up Connection

Idle Timeout: 100 (Seconds)

PPTP Configuration

My IP Address: 0.0.0.0

My IP Subnet Mask: 0.0.0.0

Server IP Address: 0.0.0.0

Connection ID/Name: _____

Back Next

Figure 3-4 Wizard 2: PPTP Encapsulation

The following table describes the fields in this screen.

Table 3-3 PPTP Encapsulation

LABEL	DESCRIPTION
ISP Parameters for Internet Access	
Encapsulation	Select PPTP from the drop-down list box.
User Name	Type the user name given to you by your ISP.
Password	Type the password associated with the User Name above.
Nailed-Up Connection	Select Nailed-Up Connection if you do not want the connection to time out.
Idle Timeout	Type the time in seconds that elapses before the router automatically disconnects from the PPTP server.
PPTP Configuration	

Table 3-3 PPTP Encapsulation

LABEL	DESCRIPTION
My IP Address	Type the (static) IP address assigned to you by your ISP.
My IP Subnet Mask	Type the subnet mask assigned to you by your ISP (if given).
Server IP Address	Type the IP address of the PPTP server.
Connection ID/Name	Enter the connection ID or connection name in this field. It must follow the "c:id" and "n:name" format. For example, C:12 or N:My ISP. This field is optional and depends on the requirements of your DSL modem.
Next	Click Next to continue.
Back	Click Back to return to the previous screen.

3.4 Wizard Setup: Screen 3

The third wizard screen allows you to configure WAN IP address assignment, DNS server address assignment and the WAN MAC address.

3.4.1 WAN IP Address Assignment

Every computer on the Internet must have a unique IP address. If your networks are isolated from the Internet, for instance, only between your two branch offices, you can assign any IP addresses to the hosts without problems. However, the Internet Assigned Numbers Authority (IANA) has reserved the following three blocks of IP addresses specifically for private networks.

Table 3-4 Private IP Address Ranges

10.0.0.0	-	10.255.255.255
172.16.0.0	-	172.31.255.255
192.168.0.0	-	192.168.255.255

You can obtain your IP address from the IANA, from an ISP or have it assigned by a private network. If you belong to a small organization and your Internet access is through an ISP, the ISP can provide you with the Internet addresses for your local networks. On the other hand, if you are part of a much larger organization, you should consult your network administrator for the appropriate IP addresses.

Regardless of your particular situation, do not create an arbitrary IP address; always follow the guidelines above. For more information on address assignment, please refer to RFC 1597, Address Allocation for Private Internets and RFC 1466, Guidelines for Management of IP Address Space.

3.4.2 IP Address and Subnet Mask

Similar to the way houses on a street share a common street name, so too do computers on a LAN share one common network number.

Where you obtain your network number depends on your particular situation. If the ISP or your network administrator assigns you a block of registered IP addresses, follow their instructions in selecting the IP addresses and the subnet mask.

If the ISP did not explicitly give you an IP network number, then most likely you have a single user account and the ISP will assign you a dynamic IP address when the connection is established. If this is the case, it is recommended that you select a network number from 192.168.0.0 to 192.168.255.0 and you must enable the Network Address Translation (NAT) feature of the ZyWALL. The Internet Assigned Number Authority (IANA) reserved this block of addresses specifically for private use; please do not use any other number unless you are told otherwise. Let's say you select 192.168.1.0 as the network number; which covers 254 individual addresses, from 192.168.1.1 to 192.168.1.254 (zero and 255 are reserved). In other words, the first three numbers specify the network number while the last number identifies an individual computer on that network.

Once you have decided on the network number, pick an IP address that is easy to remember, for instance, 192.168.1.1, for your ZyWALL, but make sure that no other device on your network is using that IP address. The subnet mask specifies the network number portion of an IP address. Your ZyWALL will compute the subnet mask automatically based on the IP address that you entered. You don't need to change the subnet mask computed by the ZyWALL unless you are instructed to do otherwise.

3.4.3 DNS Server Address Assignment

Use DNS (Domain Name System) to map a domain name to its corresponding IP address and vice versa, for instance, the IP address of www.zyxel.com is 204.217.0.2. The DNS server is extremely important because without it, you must know the IP address of a computer before you can access it.

The ZyWALL can get the DNS server addresses in the following ways.

1. The ISP tells you the DNS server addresses, usually in the form of an information sheet, when you sign up. If your ISP gives you DNS server addresses, enter them in the DNS Server fields in DHCP Setup.
2. If the ISP did not give you DNS server information, leave the DNS Server fields in DHCP Setup set to 0.0.0.0 for the ISP to dynamically assign the DNS server IP addresses.

3.4.4 WAN MAC Address

Every Ethernet device has a unique MAC (Media Access Control) address. The MAC address is assigned at the factory and consists of six pairs of hexadecimal characters, for example, 00:A0:C5:00:00:02.

You can configure the WAN port's MAC address by either using the factory default or cloning the MAC address from a computer on your LAN. Once it is successfully configured, the address will be copied to the "rom" file (ZyNOS configuration file). It will not change unless you change the setting or upload a different "rom" file.

ZyXEL recommends you clone the MAC address from a computer on your LAN even if your ISP does not require MAC address authentication.

Table 3-5 Example of Network Properties for LAN Servers with Fixed IP Addresses

Choose an IP address	192.168.1.2-192.168.1.32; 192.168.1.65-192.168.1.254.
Subnet mask	255.255.255.0
Gateway (or default route)	192.168.1.1(ZyWALL LAN IP)

The third wizard screen varies according to the type of encapsulation that you select in the second wizard screen.

Figure 3-5 Wizard 3

Table 3-6 WAN Setup

LABEL	DESCRIPTION
WAN IP Address Assignment	
Get automatically from ISP	Select this option If your ISP did not assign you a fixed IP address. This is the default selection.
Use fixed IP address	Select this option If the ISP assigned a fixed IP address.
IP Address	Enter your WAN IP address in this field if you selected Use Fixed IP Address .
IP Subnet Mask	Enter the IP subnet mask in this field if you selected Use Fixed IP Address . This field is not available when you select PPPoE encapsulation in the previous wizard screen.
Gateway IP Address	Enter the gateway IP address in this field if you selected Use Fixed IP Address . This field is not available when you select PPPoE encapsulation in the previous wizard screen.
<p>System DNS Servers (if applicable)</p> <p>DNS (Domain Name System) is for mapping a domain name to its corresponding IP address and vice versa. The DNS server is extremely important because without it, you must know the IP address of a computer before you can access it. The ZyWALL uses a system DNS server (in the order you specify here) to resolve domain names for VPN, DDNS and the time server.</p>	
First DNS Server Second DNS Server Third DNS Server	<p>Select From ISP if your ISP dynamically assigns DNS server information (and the ZyWALL's WAN IP address). The field to the right displays the (read-only) DNS server IP address that the ISP assigns.</p> <p>Select User-Defined if you have the IP address of a DNS server. Enter the DNS server's IP address in the field to the right.</p> <p>Select None if you do not want to configure DNS servers. If you do not configure a system DNS server, you must use IP addresses when configuring VPN, DDNS and the time server.</p>
DNS Server Address Assignment	DNS (Domain Name System) is for mapping a domain name to its corresponding IP address and vice versa, e.g., the IP address of www.zyxel.com is 204.217.0.2. The DNS server is extremely important because without it, you must know the IP address of a machine before you can access it.
Get automatically from ISP	Select this option if your ISP does not give you DNS server addresses. This option is selected by default.
Use fixed IP address - DNS Server IP Address	Select this option If your ISP provides you a DNS server address.
Primary/Secondary DNS Server	If you selected the Use fixed IP address – Primary/Secondary DNS Server option, enter the provided DNS addresses in these fields.

Table 3-6 WAN Setup

LABEL	DESCRIPTION
WAN MAC Address	The MAC address field allows you to configure the WAN port's MAC Address by either using the factory default or cloning the MAC address from a computer on your LAN.
Factory Default	Select this option to use the factory assigned default MAC Address.
Spoof this Computer's MAC address - IP Address	Select this option and enter the IP address of the computer on the LAN whose MAC you are cloning. Once it is successfully configured, the address will be copied to the rom file (ZyNOS configuration file). It will not change unless you change the setting or upload a different rom file. It is advisable to clone the MAC address from a computer on your LAN even if your ISP does not presently require MAC address authentication.
Back	Click Back to return to the previous screen.
Finish	Click Finish to complete and save the wizard setup.

3.5 Basic Setup Complete

Well done! You have successfully set up your ZyWALL to operate on your network and access the Internet.

Part II:

System, LAN and Wireless LAN

This part covers configuration of the system, LAN, and wireless LAN screens.

Chapter 4

System Screens

This chapter provides information on the System screens.

4.1 System Overview

See the *Wizard Setup* chapter for more information on the next few screens.

4.2 DNS Overview

There are three places where you can configure DNS (Domain Name System) setup on the ZyWALL.

1. Use the **System General** screen to configure the ZyWALL to use a DNS server to resolve domain names for ZyWALL system features like VPN, DDNS and the time server.
2. Use the **LAN IP** screen to configure the DNS server information that the ZyWALL sends to the DHCP client devices on the LAN.
3. Use the **Remote Management DNS** screen to configure the ZyWALL to accept or discard DNS queries.

4.3 Configuring General Setup

Click **SYSTEM** to open the **General** screen.

SYSTEM

General DDNS Password Time Setting

System Name

Domain Name

Administrator Inactivity Timer (Min: 1, 0 means no timeout)

System DNS Servers

First DNS Server

Second DNS Server

Third DNS Server

Apply Reset

Figure 4-1 System General Setup

The following table describes the labels in this screen.

Table 4-1 System General Setup

LABEL	DESCRIPTION
System Name	Choose a descriptive name for identification purposes. It is recommended you enter your computer's "Computer name" in this field (see the <i>Wizard Setup</i> chapter for how to find your computer's name). This name can be up to 30 alphanumeric characters long. Spaces are not allowed, but dashes "-" and underscores "_" are accepted.
Domain Name	Enter the domain name (if you know it) here. If you leave this field blank, the ISP may assign a domain name via DHCP. The domain name entered by you is given priority over the ISP assigned domain name.
Administrator Inactivity Timer	Type how many minutes a management session (either via the web configurator or SMT) can be left idle before the session times out. The default is 5 minutes. After it times out you have to log in with your password again. Very long idle timeouts may have security risks. A value of "0" means a management session never times out, no matter how long it has been left idle (not recommended).
<p>System DNS Servers (if applicable)</p> <p>DNS (Domain Name System) is for mapping a domain name to its corresponding IP address and vice versa. The DNS server is extremely important because without it, you must know the IP address of a machine before you can access it. The ZyWALL uses a system DNS server (in the order you specify here) to resolve domain names for VPN, DDNS and the time server.</p>	
First DNS Server Second DNS Server Third DNS Server	<p>Select From ISP if your ISP dynamically assigns DNS server information (and the ZyWALL's WAN IP address). The field to the right displays the (read-only) DNS server IP address that the ISP assigns.</p> <p>Select User-Defined if you have the IP address of a DNS server. Enter the DNS server's IP address in the field to the right. If you chose User-Defined, but leave the IP address set to 0.0.0.0, User-Defined changes to None after you click Apply. If you set a second choice to User-Defined, and enter the same IP address, the second User-Defined changes to None after you click Apply.</p> <p>Select None if you do not want to configure DNS servers. If you do not configure a system DNS server, you must use IP addresses when configuring VPN, DDNS and the time server.</p>
Apply	Click Apply to save your changes back to the ZyWALL.
Reset	Click Reset to begin configuring this screen afresh.

4.4 Dynamic DNS

Dynamic DNS (Domain Name System) allows you to update your current dynamic IP address with one or many dynamic DNS services so that anyone can contact you (in NetMeeting, CU-SeeMe or other services). This is for people with a dynamic IP address from their ISP or DHCP server that would still like to have a domain name. You can also access your FTP server or Web site on your own computer using a DNS-like address (for example, myhost.dhs.org, where myhost is a name of your choice), which will never change instead of using an IP address that changes each time you reconnect. Your friends or relatives will always be able to call you even if they don't know your IP address.

To use this service, you must register with the Dynamic DNS service provider. The Dynamic DNS service provider will give you a password or key.

4.4.1 DYNDNS Wildcard

Enabling the wildcard feature for your host causes *.yourhost.dyndns.org to be aliased to the same IP address as yourhost.dyndns.org. This feature is useful if you want to be able to use, for example, www.yourhost.dyndns.org and still reach your hostname.

If you have a private WAN IP address, then you cannot use Dynamic DNS.

4.5 Configuring Dynamic DNS

To change your ZyWALL's DDNS, click **SYSTEM**, then the **DDNS** tab. The screen appears as shown.

Figure 4-2 DDNS

The following table describes the labels in this screen.

Table 4-2 DDNS

LABEL	DESCRIPTION
Active	Select this check box to use dynamic DNS.
Service Provider	Select the name of your Dynamic DNS service provider.
DDNS Type	Select the type of service that you are registered for from your Dynamic DNS service provider.
Host Names 1~3	Enter the host names in the three fields provided. You can specify up to two host names in each field separated by a comma (",").
User	Enter your user name.
Password	Enter the password assigned to you.
Enable Wildcard	Select the check box to enable DYNDNS Wildcard.

Table 4-2 DDNS

LABEL	DESCRIPTION
Off Line	This option is available when CustomDNS is selected in the DDNS Type field. Check with your Dynamic DNS service provider to have traffic redirected to a URL (that you can specify) while you are off line.
Edit Update IP Address:	
Server Auto Detect	Select this option to update the IP address of the host name(s) automatically by the DDNS server. It is recommended that you select this option.
User Specify	Select this option to update the IP address of the host name(s) to the IP address specified below. Use this option if you have a static IP address.
IP Address	Enter the IP address if you select the User Specify option.
Apply	Click Apply to save your changes back to the ZyWALL.
Reset	Click Reset to begin configuring this screen afresh.

4.6 Configuring Password

To change your ZyWALL's password (recommended), click **SYSTEM**, then the **Password** tab. The screen appears as shown. This screen allows you to change the ZyWALL's password.

Figure 4-3 Password

The following table describes the labels in this screen.

Table 4-3 Password

LABEL	DESCRIPTION
Old Password	Type the default password or the existing password you use to access the system in this field.
New Password	Type the new password in this field.
Retype to Confirm	Type the new password again in this field.
Apply	Click Apply to save your changes back to the ZyWALL.
Reset	Click Reset to begin configuring this screen afresh.

4.7 Pre-defined NTP Time Servers List

The ZyWALL uses the following pre-defined list of NTP time servers if you do not specify a time server or it cannot synchronize with the time server you specified.

The ZyWALL can use this pre-defined list of time servers regardless of the Time Protocol you select.

When the ZyWALL uses the pre-defined list of NTP time servers, it randomly selects one server and tries to synchronize with it. If the synchronization fails, then the ZyWALL goes through the rest of the list in order from the first one tried until either it is successful or all the pre-defined NTP time servers have been tried.

Table 4-4 Pre-defined Time Servers

ntp1.cs.wisc.edu
ntp1.gbg.netnod.se
ntp2.cs.wisc.edu
tock.usno.navy.mil
ntp3.cs.wisc.edu
ntp.cs.strath.ac.uk
ntp1.sp.se
time1.stupi.se
tick.stdtime.gov.tw
tock.stdtime.gov.tw
time.stdtime.gov.tw

4.8 Configuring Time Setting

To change your ZyWALL's time and date, click **SYSTEM**, then the **Time Setting** tab. The screen appears as shown. Use this screen to configure the ZyWALL's time based on your local time zone.

Figure 4-4 Time Setting

The following table describes the labels in this screen.

Table 4-5 Time Setting

LABEL	DESCRIPTION
Time Protocol (or Use Time Server when Bootup)	<p>Select the time service protocol that your time server sends when you turn on the ZyWALL. Not all time servers support all protocols, so you may have to check with your ISP/network administrator or use trial and error to find a protocol that works.</p> <p>The main difference between them is the format. Daytime (RFC 867) format is day/month/year/time zone of the server. Time (RFC 868) format displays a 4-byte integer giving the total number of seconds since 1970/1/1 at 0:0:0. The default, NTP (RFC 1305), is similar to Time (RFC 868). Select None to enter the time and date manually.</p>
Time Server Address	Enter the IP address or URL of your time server. Check with your ISP or network administrator if you are unsure of this information.
Current Time	This field displays the time of your ZyWALL. Each time you reload this page, the ZyWALL synchronizes the time with the time server.
New Time	This field displays the last updated time from the time server. When you select None in the Time Protocol field, enter the new time in this field and then click Apply .
Current Date	This field displays the date of your ZyWALL. Each time you reload this page, the ZyWALL synchronizes the time with the time server.
New Date	This field displays the last updated date from the time server. When you select None in the Time Protocol field, enter the new date in this field and then click Apply .
Time Zone	Choose the Time Zone of your location. This will set the time difference between your time zone and Greenwich Mean Time (GMT).
Daylight Savings	Select this option if you use daylight savings time. Daylight saving is a period from late spring to early fall when many countries set their clocks ahead of normal local time by one hour to give more daytime light in the evening.
Start Date	Enter the month and day that your daylight-savings time starts on if you selected Daylight Savings .
End Date	Enter the month and day that your daylight-savings time ends on if you selected Daylight Savings .
Apply	Click Apply to save your changes back to the ZyWALL.
Reset	Click Reset to begin configuring this screen afresh.

Chapter 5

LAN Screens

This chapter describes how to configure LAN settings.

5.1 LAN Overview

Local Area Network (LAN) is a shared communication system to which many computers are attached. The LAN screens can help you configure a LAN DHCP server, manage IP addresses, and partition your physical network into logical networks.

5.2 DHCP Setup

DHCP (Dynamic Host Configuration Protocol, RFC 2131 and RFC 2132) allows individual clients to obtain TCP/IP configuration at start-up from a server. You can configure the ZyWALL as a DHCP server or disable it. When configured as a server, the ZyWALL provides the TCP/IP configuration for the clients. If DHCP service is disabled, you must have another DHCP server on your LAN, or else the computer must be manually configured.

5.2.1 IP Pool Setup

The ZyWALL is pre-configured with a pool of 32 IP addresses starting from 192.168.1.33 to 192.168.1.64. This configuration leaves 31 IP addresses (excluding the ZyWALL itself) in the lower range for other server computers, for instance, servers for mail, FTP, TFTP, web, etc., that you may have.

5.2.2 DNS Servers

Use the **LAN IP** screen to configure the DNS server information that the ZyWALL sends to the DHCP client devices on the LAN.

5.3 LAN TCP/IP

The ZyWALL has built-in DHCP server capability that assigns IP addresses and DNS servers to systems that support DHCP client capability.

5.3.1 Factory LAN Defaults

The LAN parameters of the ZyWALL are preset in the factory with the following values:

- IP address of 192.168.1.1 with subnet mask of 255.255.255.0 (24 bits)
- DHCP server enabled with 32 client IP addresses starting from 192.168.1.33.

These parameters should work for the majority of installations. If your ISP gives you explicit DNS server address(es), read the embedded web configurator help regarding what fields need to be configured.

5.3.2 IP Address and Subnet Mask

Refer to the *IP Address and Subnet Mask* section in the **Wizard Setup** chapter for this information.

5.3.3 RIP Setup

RIP (Routing Information Protocol, RFC 1058 and RFC 1389) allows a router to exchange routing information with other routers. **RIP Direction** controls the sending and receiving of RIP packets. When set to **Both** or **Out Only**, the ZyWALL will broadcast its routing table periodically. When set to **Both** or **In Only**, it will incorporate the RIP information that it receives; when set to **None**, it will not send any RIP packets and will ignore any RIP packets received.

RIP Version controls the format and the broadcasting method of the RIP packets that the ZyWALL sends (it recognizes both formats when receiving). **RIP-1** is universally supported; but **RIP-2** carries more information. RIP-1 is probably adequate for most networks, unless you have an unusual network topology.

Both **RIP-2B** and **RIP-2M** send routing data in RIP-2 format; the difference being that **RIP-2B** uses subnet broadcasting while **RIP-2M** uses multicasting. Multicasting can reduce the load on non-router machines since they generally do not listen to the RIP multicast address and so will not receive the RIP packets. However, if one router uses multicasting, then all routers on your network must use multicasting, also.

By default, **RIP Direction** is set to **Both** and **RIP Version** to **RIP-1**.

5.3.4 Multicast

Traditionally, IP packets are transmitted in one of either two ways - Unicast (1 sender - 1 recipient) or Broadcast (1 sender - everybody on the network). Multicast delivers IP packets to a group of hosts on the network - not everybody and not just 1.

IGMP (Internet Group Multicast Protocol) is a network-layer protocol used to establish membership in a Multicast group - it is not used to carry user data. IGMP version 2 (RFC 2236) is an improvement over version 1 (RFC 1112) but IGMP version 1 is still in wide use. If you would like to read more detailed information about interoperability between IGMP version 2 and version 1, please see sections 4 and 5 of RFC 2236. The class D IP address is used to identify host groups and can be in the range 224.0.0.0 to 239.255.255.255. The address 224.0.0.0 is not assigned to any group and is used by IP multicast computers. The address 224.0.0.1 is used for query messages and is assigned to the permanent group of all IP hosts (including gateways). All hosts must join the 224.0.0.1 group in order to participate in IGMP. The address 224.0.0.2 is assigned to the multicast routers group.

The ZyWALL supports both IGMP version 1 (**IGMP-v1**) and IGMP version 2 (**IGMP-v2**). At start up, the ZyWALL queries all directly connected networks to gather group membership. After that, the ZyWALL periodically updates this information. IP multicasting can be enabled/disabled on the ZyWALL LAN and/or WAN interfaces in the web configurator (**LAN**; **WAN**). Select **None** to disable IP multicasting on these interfaces.

5.4 Configuring IP

Click **LAN** to open the **IP** screen.

Figure 5-1 IP

The following table describes the labels in this screen.

Table 5-1 IP

LABEL	DESCRIPTION
DHCP Server	DHCP (Dynamic Host Configuration Protocol, RFC 2131 and RFC 2132) allows individual clients (computers) to obtain TCP/IP configuration at startup from a server. Leave the DHCP Server check box selected unless your ISP instructs you to do otherwise. Clear it to disable the ZyWALL acting as a DHCP server. When configured as a server, the ZyWALL provides TCP/IP configuration for the clients. If not, DHCP service is disabled and you must have another DHCP server on your LAN, or else the computers must be manually configured. When set as a server, fill in the rest of the DHCP setup fields.
IP Pool Starting Address	This field specifies the first of the contiguous addresses in the IP address pool.

Table 5-1 IP

LABEL	DESCRIPTION
Pool Size	This field specifies the size, or count of the IP address pool.
<p>DNS Servers Assigned by DHCP Server</p> <p>The ZyWALL passes a DNS (Domain Name System) server IP address (in the order you specify here) to the DHCP clients. The ZyWALL only passes this information to the LAN DHCP clients when you select the DHCP Server check box. When you clear the DHCP Server check box, DHCP service is disabled and you must have another DHCP sever on your LAN, or else the computers must have their DNS server addresses manually configured.</p>	
First DNS Server Second DNS Server Third DNS Server	<p>Select From ISP if your ISP dynamically assigns DNS server information (and the ZyWALL's WAN IP address). The field to the right displays the (read-only) DNS server IP address that the ISP assigns.</p> <p>Select User-Defined if you have the IP address of a DNS server. Enter the DNS server's IP address in the field to the right. If you chose User-Defined, but leave the IP address set to 0.0.0.0, User-Defined changes to None after you click Apply. If you set a second choice to User-Defined, and enter the same IP address, the second User-Defined changes to None after you click Apply.</p> <p>Select DNS Relay to have the ZyWALL act as a DNS proxy. The ZyWALL's LAN IP address displays in the field to the right (read-only). The ZyWALL tells the DHCP clients on the LAN that the ZyWALL itself is the DNS server. When a computer on the LAN sends a DNS query to the ZyWALL, the ZyWALL forwards the query to the ZyWALL's system DNS server (configured in the SYSTEM General screen) and relays the response back to the computer. You can only select DNS Relay for one of the three servers; if you select DNS Relay for a second or third DNS server, that choice changes to None after you click Apply.</p> <p>Select None if you do not want to configure DNS servers. If you do not configure a DNS server, you must know the IP address of a computer in order to access it.</p>
LAN TCP/IP	
IP Address	Type the IP address of your ZyWALL in dotted decimal notation 192.168.1.1 (factory default).
IP Subnet Mask	The subnet mask specifies the network number portion of an IP address. Your ZyWALL will automatically calculate the subnet mask based on the IP address that you assign. Unless you are implementing subnetting, use the subnet mask computed by the ZyWALL 255.255.255.0.

Table 5-1 IP

LABEL	DESCRIPTION
RIP Direction	RIP (Routing Information Protocol, RFC1058 and RFC 1389) allows a router to exchange routing information with other routers. The RIP Direction field controls the sending and receiving of RIP packets. Select the RIP direction from Both/In Only/Out Only/None . When set to Both or Out Only , the ZyWALL will broadcast its routing table periodically. When set to Both or In Only , it will incorporate the RIP information that it receives; when set to None , it will not send any RIP packets and will ignore any RIP packets received. Both is the default.
RIP Version	The RIP Version field controls the format and the broadcasting method of the RIP packets that the ZyWALL sends (it recognizes both formats when receiving). RIP-1 is universally supported but RIP-2 carries more information. RIP-1 is probably adequate for most networks, unless you have an unusual network topology. Both RIP-2B and RIP-2M sends the routing data in RIP-2 format; the difference being that RIP-2B uses subnet broadcasting while RIP-2M uses multicasting. Multicasting can reduce the load on non-router machines since they generally do not listen to the RIP multicast address and so will not receive the RIP packets. However, if one router uses multicasting, then all routers on your network must use multicasting, also. By default, RIP direction is set to Both and the Version set to RIP-1 .
Multicast	Select IGMP V-1 or IGMP V-2 or None . IGMP (Internet Group Multicast Protocol) is a network-layer protocol used to establish membership in a Multicast group - it is not used to carry user data. IGMP version 2 (RFC 2236) is an improvement over version 1 (RFC 1112) but IGMP version 1 is still in wide use. If you would like to read more detailed information about interoperability between IGMP version 2 and version 1, please see <i>sections 4 and 5 of RFC 2236</i> .
Windows Networking (NetBIOS over TCP/IP): NetBIOS (Network Basic Input/Output System) are TCP or UDP broadcast packets that enable a computer to connect to and communicate with a LAN. For some dial-up services such as PPPoE or PPTP, NetBIOS packets cause unwanted calls. However it may sometimes be necessary to allow NetBIOS packets to pass through to the WAN in order to find a computer on the WAN.	
Allow From LAN to WAN	Select this option to forward NetBIOS packets from the LAN port to the WAN port.
Allow From LAN to DMZ	Select this option to forward NetBIOS packets from the LAN port to the DMZ port. (Not all ZyWALL models have a DMZ port.)
Apply	Click Apply to save your changes back to the ZyWALL.
Reset	Click Reset to begin configuring this screen afresh.

5.5 Configuring Static DHCP

This table allows you to assign IP addresses on the LAN to specific individual computers based on their MAC Addresses.

Every Ethernet device has a unique MAC (Media Access Control) address. The MAC address is assigned at the factory and consists of six pairs of hexadecimal characters, for example, 00:A0:C5:00:00:02.

To change your ZyWALL's Static DHCP settings, click **LAN**, then the **Static DHCP** tab. The screen appears as shown.

#	MAC Address	IP Address
1		0.0.0.0
2		0.0.0.0
3		0.0.0.0
4		0.0.0.0
5		0.0.0.0
6		0.0.0.0
7		0.0.0.0
8		0.0.0.0

Figure 5-2 Static DHCP

The following table describes the labels in this screen.

Table 5-2 Static DHCP

LABEL	DESCRIPTION
#	This is the index number of the Static IP table entry (row).
MAC Address	Type the MAC address (with colons) of a computer on your LAN.
IP Address	This field specifies the size, or count of the IP address pool.
Apply	Click Apply to save your changes back to the ZyWALL.
Reset	Click Reset to begin configuring this screen afresh.

5.6 Configuring IP Alias

IP Alias allows you to partition a physical network into different logical networks over the same Ethernet interface. The ZyWALL supports three logical LAN interfaces via its single physical Ethernet interface with the ZyWALL itself as the gateway for each LAN network.

When you use IP alias, you can also configure firewall rules to control access between the LAN's logical networks (subnets).

The following figure shows a LAN divided into subnets A, B, and C.



Figure 5-3 Physical Network

Figure 5-4 Partitioned Logical Networks

To change your ZyWALL's IP Alias settings, click **LAN**, then the **IP Alias** tab. The screen appears as shown.

Make sure that the subnets of the logical networks do not overlap.

The screenshot shows the LAN configuration interface with three tabs: IP, Static DHCP, and IP Alias. The IP Alias tab is active, displaying two sections for IP Alias 1 and IP Alias 2. Each section includes a checkbox, IP Address, IP Subnet Mask, RIP Direction, and RIP Version fields. The IP Address and IP Subnet Mask fields are set to 0.0.0.0. The RIP Direction is set to None and the RIP Version is set to RIP-1. There are Apply and Reset buttons at the bottom.

Figure 5-5 IP Alias

The following table describes the labels in this screen.

Table 5-3 IP Alias

LABEL	DESCRIPTION
IP Alias 1,2	Select the check box to configure another LAN network for the ZyWALL.
IP Address	Enter the IP address of your ZyWALL in dotted decimal notation.
IP Subnet Mask	Your ZyWALL will automatically calculate the subnet mask based on the IP address that you assign. Unless you are implementing subnetting, use the subnet mask computed by the ZyWALL.
RIP Direction	RIP (Routing Information Protocol, RFC1058 and RFC 1389) allows a router to exchange routing information with other routers. The RIP Direction field controls the sending and receiving of RIP packets. Select the RIP direction from Both/In Only/Out Only/None . When set to Both or Out Only , the ZyWALL will broadcast its routing table periodically. When set to Both or In Only , it will incorporate the RIP information that it receives; when set to None , it will not send any RIP packets and will ignore any RIP packets received.

Table 5-3 IP Alias

LABEL	DESCRIPTION
RIP Version	The RIP Version field controls the format and the broadcasting method of the RIP packets that the ZyWALL sends (it recognizes both formats when receiving). RIP-1 is universally supported but RIP-2 carries more information. RIP-1 is probably adequate for most networks, unless you have an unusual network topology. Both RIP-2B and RIP-2M sends the routing data in RIP-2 format; the difference being that RIP-2B uses subnet broadcasting while RIP-2M uses multicasting. Multicasting can reduce the load on non-router machines since they generally do not listen to the RIP multicast address and so will not receive the RIP packets. However, if one router uses multicasting, then all routers on your network must use multicasting, also. By default, RIP direction is set to Both and the Version set to RIP-1 .
Apply	Click Apply to save your changes back to the ZyWALL.
Reset	Click Reset to begin configuring this screen afresh.

Chapter 6

Wireless LAN Screens

*This chapter discusses how to configure Wireless LAN on the ZyWALL. See the chapter on Authentication Server for the **Local User Database** and **RADIUS** screens.*

6.1 Wireless LAN Overview

This section introduces the wireless LAN (WLAN) and some basic scenarios.

6.1.1 Additional Installation Requirements for Using 802.1x

- A computer with an IEEE 802.11b wireless LAN card.
- A computer equipped with a web browser (with JavaScript enabled) and/or Telnet.
- A wireless client computer must be running IEEE 802.1x-compliant software. Currently, this is offered in Windows XP.
- An optional network RADIUS server for remote user authentication and accounting.

6.2 Wireless LAN Basics

This section provides background information on WLAN.

6.2.1 Channel

IEEE 802.11b wireless devices use radio frequencies called channels. Choose the radio channel depending on your geographical area. Adjacent Access Points (APs) should use different channels to reduce crosstalk. Crosstalk occurs when radio signals from access points overlap and cause interference that degrades performance.

6.2.2 ESS ID

Extended Service Set (ESS) is defined as one or more APs acting as a bridge between a wired LAN and the associated wireless clients. The ESS ID is a unique ID given to the APs and the wireless clients that participate in the same wireless network. You can think of the ESS ID as being similar to a workgroup name in a Microsoft network.

6.2.3 RTS/CTS

A hidden node occurs when two stations are within range of the same access point, but are not within range of each other. The following figure illustrates a hidden node. Both stations (STA) are within range of the access point (AP) or wireless gateway, but out-of-range of each other, so they cannot “hear” each other, that is they do not know if the channel is currently being used. Therefore, they are considered hidden from each other.

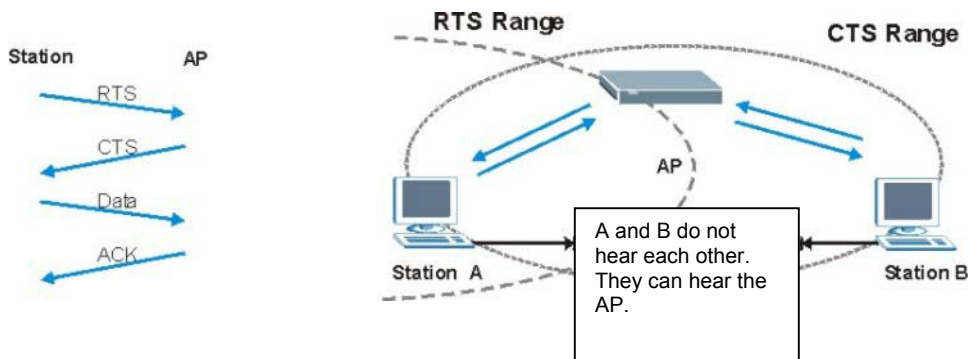

Figure 6-1 RTS Threshold

When station A sends data to the ZyWALL, it might not know that the station B is already using the channel. If these two stations send data at the same time, collisions may occur when both sets of data arrive at the AP at the same time, resulting in a loss of messages for both stations.

RTS/CTS is designed to prevent collisions due to hidden nodes. An **RTS/CTS** defines the biggest size data frame you can send before an RTS (Request To Send)/CTS (Clear to Send) handshake is invoked.

When a data frame exceeds the **RTS/CTS** value you set (between 0 to 2432 bytes), the station that wants to transmit this frame must first send an RTS (Request To Send) message to the AP for permission to send it. The AP then responds with a CTS (Clear to Send) message to all other stations within its range to notify them to defer their transmission. It also reserves and confirms with the requesting station the time frame for the requested transmission.

Stations can send frames smaller than the specified **RTS/CTS** directly to the AP without the RTS (Request To Send)/CTS (Clear to Send) handshake.

You should only configure **RTS/CTS** if the possibility of hidden nodes exists on your network and the “cost” of resending large frames is more than the extra network overhead involved in the RTS (Request To Send)/CTS (Clear to Send) handshake.

If the **RTS/CTS** value is greater than the **Fragmentation Threshold** value (see next), then the RTS (Request To Send)/CTS (Clear to Send) handshake will never occur as data frames will be fragmented before they reach **RTS/CTS** size.

Enabling the RTS Threshold causes redundant network overhead that could negatively affect the throughput performance instead of providing a remedy.

6.2.4 Fragmentation Threshold

A **Fragmentation Threshold** is the maximum data fragment size (between 256 and 2432 bytes) that can be sent in the wireless network before the ZyWALL will fragment the packet into smaller data frames.

A large **Fragmentation Threshold** is recommended for networks not prone to interference while you should set a smaller threshold for busy networks or networks that are prone to interference.

If the **Fragmentation Threshold** value is smaller than the **RTS/CTS** value (see previously) you set then the RTS (Request To Send)/CTS (Clear to Send) handshake will never occur as data frames will be fragmented before they reach **RTS Threshold** size.

6.3 Wireless Security

Wireless security is vital to your network to protect wireless communication between wireless clients, access points and other wireless.

The figure below shows the possible wireless security levels on your ZyWALL. The highest security level is EAP (Extensible Authentication Protocol) authentication. It requires interaction with a RADIUS (Remote Authentication Dial In User Service) server either on the WAN or your LAN to provide authentication service for wireless clients.

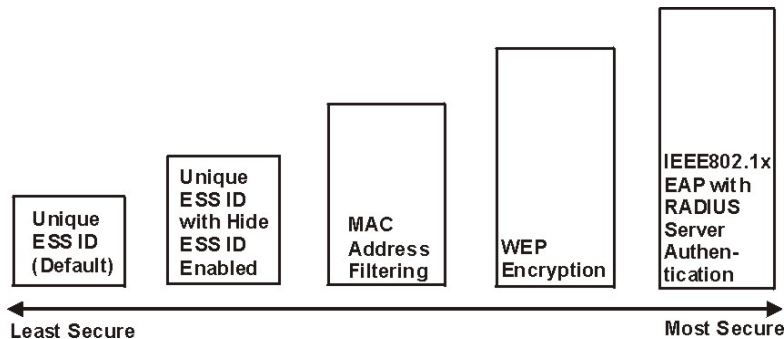

Figure 6-2 ZyWALL Wireless Security Levels

If you do not enable any wireless security on your ZyWALL, your network is accessible to any wireless networking device that is within range.

Use the ZyWALL web configurator to configurator to set up your wireless LAN security settings. Refer to the chapter on using the ZyWALL web configurator to see how to access the web configurator.

6.3.1 WEP

WEP provides a mechanism for encrypting data using encryption keys. Both the AP and the wireless stations must use the same WEP key to encrypt and decrypt data. Your ZyWALL allows you to configure up to four 64-bit or 128-bit WEP keys, but only one key can be enabled at any one time.

6.4 Configuring Wireless LAN

If you are configuring the ZyWALL from a computer connected to the wireless LAN and you change the ZyWALL's ESSID or WEP settings, you will lose your wireless connection when you press Apply to confirm. You must then change the wireless settings of your computer to match the ZyWALL's new settings.

Click **WIRELESS LAN** to open the **Wireless** screen.

Figure 6-3 Wireless

The following table describes the labels in this screen.

Table 6-1 Wireless

LABEL	DESCRIPTION
Enable Wireless LAN	The wireless LAN is turned off (No) by default, before you enable the wireless LAN you should configure some security by setting MAC filters and/or 802.1x security; otherwise your wireless LAN will be vulnerable upon enabling it. Select the check box to enable the wireless LAN.
ESSID	The ESSID (Extended Service Set IDentity) identifies the AP to which the wireless stations associate. Wireless stations associating to the AP must have the same ESSID. Enter a descriptive name.
Hide ESSID	Select Yes to hide the ESSID in the outgoing beacon frame so a station cannot obtain the ESSID through passive scanning.
Channel ID	This allows you to set the operating frequency/channel depending on your particular region. Select a channel from the drop-down list box. CH01 2412 MHz / CH02 2417 MHz ~ CH11 2462 MHz (North America/FCC) CH01 2412 MHz / CH02 2417 MHz ~ CH13 2472 MHz (Europe CE/ ETSI) CH01 2412 MHz / CH02 2417 MHz ~ Ch14 2484 MHz (Japan) CH10 2457 MHz / CH11 2462 MHz (Spain) CH10 2457 MHz / CH11 2462 MHz ~ CH13 2472 MHz (France)
RTS Threshold	(Request To Send) The threshold (number of bytes) for enabling RTS/CTS handshake. Data with its frame size larger than this value will perform the RTS/CTS handshake. Setting this attribute to be larger than the maximum MSDU (MAC service data unit) size turns off the RTS/CTS handshake. Setting this attribute to zero turns on the RTS/CTS handshake. Enter a value between 0 and 2432 .
Frag. Threshold	The threshold (number of bytes) for the fragmentation boundary for directed messages. It is the maximum data fragment size that can be sent. Enter a value between 256 and 2432 .
WEP	WEP (Wired Equivalent Privacy) provides data encryption to prevent unauthorized wireless stations from accessing data transmitted over the wireless network. Select Disable to allow wireless clients to communicate with the access points without any data encryption. Select 64-bit WEP or 128-bit WEP to enable data encryption. Although WEP is functional at 5.5 and 11 Mbps, there is significant performance degradation when using WEP at these rates.

Table 6-1 Wireless

LABEL	DESCRIPTION
Key 1 to Key 4	If you chose 64-bit WEP in the WEP Encryption field, then enter any 5 characters (ASCII string) or 10 hexadecimal characters ("0-9", "A-F") preceded by 0x for each key. If you chose 128-bit WEP in the WEP Encryption field, then enter 13 characters (ASCII string) or 26 hexadecimal characters ("0-9", "A-F") preceded by 0x for each key. There are four data encryption keys to secure your data from eavesdropping by unauthorized wireless users. The values for the keys must be set up exactly the same on the access points as they are on the wireless client computers.
Apply	Click Apply to save your changes back to the ZyWALL.
Reset	Click Reset to begin configuring this screen afresh.

6.5 Configuring MAC Filter

The MAC filter screen allows you to configure the ZyWALL to give exclusive access to specific devices (**Allow Association**) or exclude specific devices from accessing the ZyWALL (**Deny Association**). Every Ethernet device has a unique MAC (Media Access Control) address. The MAC address is assigned at the factory and consists of six pairs of hexadecimal characters, for example, 00:A0:C5:00:00:02. You need to know the MAC address of the devices to configure this screen.

To change your ZyWALL's MAC Filter settings, click **WIRELESS LAN**, then the **MAC Filter** tab. The screen appears as shown.

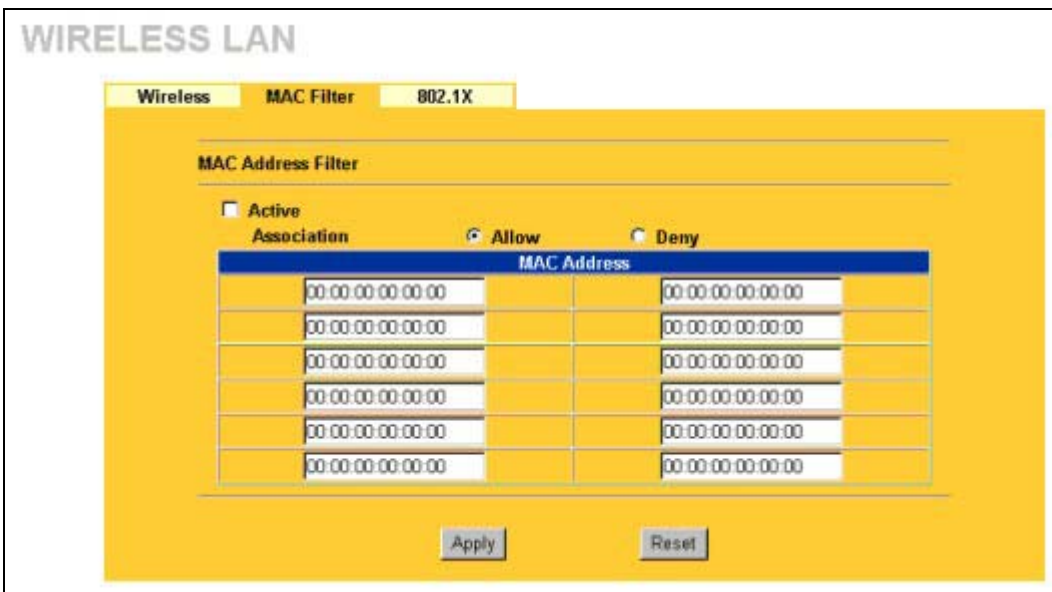

Figure 6-4 MAC Address Filter

The following table describes the labels in this menu.

Table 6-2 MAC Address Filter

LABEL	DESCRIPTION
Active	Enable MAC address filtering to have the router allow or deny access to wireless stations based on MAC addresses. Disable MAC address filtering to have the router not perform MAC filtering on the wireless stations.
Filter Action	Define the filter action for the list of MAC addresses in the MAC address filter table. Select Deny Association to block access to the router, MAC addresses not listed will be allowed to access the router. Select Allow Association to permit access to the router, MAC addresses not listed will be denied access to the router.
MAC Address	Enter the MAC addresses (in XX:XX:XX:XX:XX:XX format) of the client computers that are allowed or denied access to the ZyWALL in these address fields.
Apply	Click Apply to save your changes back to the ZyWALL.
Reset	Click Reset to begin configuring this screen afresh.

6.6 802.1x Overview

The IEEE 802.1x standard outlines enhanced security methods for both the authentication of wireless stations and encryption key management. Authentication can be done using the local user database internal to the ZyWALL or an external RADIUS server for an unlimited number of users.

6.7 Configuring 802.1X

To change your ZyWALL's Authentication settings, click **WIRELESS LAN**, then the **802.1X** tab. The screen appears as shown.

Figure 6-5 802.1X Authentication

The following table describes the labels in this screen.

Table 6-3 802.1X Authentication

LABEL	DESCRIPTION
Authentication Type	Select Authentication Required to authenticate all wireless clients before they can access the wired network. Select No Authentication Required to allow all wireless clients to access your wired network without authentication. Select No Access to deny all wireless clients access to your wired network.
Reauthentication Period	Specify the time interval between the RADIUS server's authentication checks of wireless users connected to the network. This field is activated only when you select Authentication Required in the Authentication Type field.
Apply	Click Apply to save your changes back to the ZyWALL.

Table 6-3 802.1X Authentication

LABEL	DESCRIPTION
Reset	Click Reset to begin configuring this screen afresh.

Part III:

DMZ and WAN

This part covers configuration of the DMZ and WAN screens.

Chapter 7

DMZ Screens

This chapter describes how to configure the ZyWALL's DMZ.

7.1 DMZ Overview

The DeMilitarized Zone (DMZ) auto-negotiating 10/100 Mbps Ethernet port provides a way for public servers (Web, e-mail, FTP, etc.) to be visible to the outside world (while still being protected from DoS (Denial of Service) attacks such as SYN flooding and Ping of Death). These public servers can also still be accessed from the secure LAN.

By default the firewall allows traffic between the WAN and the DMZ, traffic from the DMZ to the LAN is denied, and traffic from the LAN to the DMZ is allowed. Internet users can have access to host servers on the DMZ but no access to the LAN, unless special filter rules allowing access were configured by the administrator or the user is an authorized remote user.

It is highly recommended that you connect all of your public servers to the DMZ port. If you have more than one public server, connect a hub to the DMZ port.

It is also highly recommended that you keep all sensitive information off of the public servers connected to the DMZ port. Store sensitive information on LAN computers.

7.2 DMZ Addresses

You can assign public or private IP addresses to computers connected to the DMZ port.

With public IP addresses, the WAN and DMZ ports must use public IP addresses that are on separate subnets. See the appendices for information on IP subnetting.

If the DMZ computers use private IP addresses, go to the **WAN IP** screen and select **SUA Only** or **Full Feature** in the **Network Address Translation** field. Configure NAT mapping rules for the private IP addresses of the computers on the DMZ

7.3 Configuring DMZ

From the **MAIN MENU**, click **DMZ**. The screen appears as shown next.

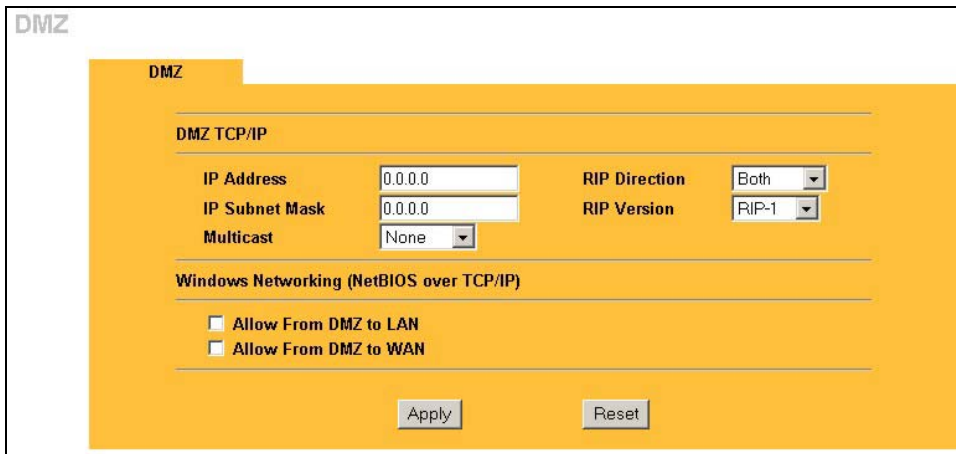

Figure 7-1 DMZ (ZyWALL 100)

The following table describes the labels in this screen.

Table 7-1 DMZ

LABEL	DESCRIPTION
DMZ TCP/IP	
IP Address	Type the IP address of your ZyWALL in dotted decimal notation 192.168.1.1 (factory default).
IP Subnet Mask	The subnet mask specifies the network number portion of an IP address. Your ZyWALL will automatically calculate the subnet mask based on the IP address that you assign. Unless you are implementing subnetting, use the subnet mask computed by the ZyWALL 255.255.255.0.
RIP Direction	RIP (Routing Information Protocol, RFC1058 and RFC 1389) allows a router to exchange routing information with other routers. The RIP Direction field controls the sending and receiving of RIP packets. Select the RIP direction from Both/In Only/Out Only/None . When set to Both or Out Only , the ZyWALL will broadcast its routing table periodically. When set to Both or In Only , it will incorporate the RIP information that it receives; when set to None , it will not send any RIP packets and will ignore any RIP packets received. Both is the default.

Table 7-1 DMZ

LABEL	DESCRIPTION
RIP Version	The RIP Version field controls the format and the broadcasting method of the RIP packets that the ZyWALL sends (it recognizes both formats when receiving). RIP-1 is universally supported but RIP-2 carries more information. RIP-1 is probably adequate for most networks, unless you have an unusual network topology. Both RIP-2B and RIP-2M sends the routing data in RIP-2 format; the difference being that RIP-2B uses subnet broadcasting while RIP-2M uses multicasting. Multicasting can reduce the load on non-router machines since they generally do not listen to the RIP multicast address and so will not receive the RIP packets. However, if one router uses multicasting, then all routers on your network must use multicasting, also. By default, RIP direction is set to Both and the Version set to RIP-1 .
Multicast	Select IGMP V-1 or IGMP V-2 or None . IGMP (Internet Group Multicast Protocol) is a network-layer protocol used to establish membership in a Multicast group - it is not used to carry user data. IGMP version 2 (RFC 2236) is an improvement over version 1 (RFC 1112) but IGMP version 1 is still in wide use. If you would like to read more detailed information about interoperability between IGMP version 2 and version 1, please see <i>sections 4 and 5 of RFC 2236</i> .
Windows Networking (NetBIOS over TCP/IP)	
Allow from DMZ to LAN	Click this option to forward NetBIOS packets from the DMZ port to the LAN port.
Allow from DMZ to WAN	Click this option to forward NetBIOS packets from the DMZ port to the WAN port.
Apply	Click Apply to save your changes back to the ZyWALL.
Reset	Click Reset to begin configuring this screen afresh.

Chapter 8

WAN Screens

This chapter describes how to configure WAN settings.

8.1 WAN Overview

See the *Wizard Setup* chapter for more information on the fields in the WAN screens.

8.2 TCP/IP Priority (Metric)

The metric represents the "cost of transmission". A router determines the best route for transmission by choosing a path with the lowest "cost". RIP routing uses hop count as the measurement of cost, with a minimum of "1" for directly connected networks. The number must be between "1" and "15"; a number greater than "15" means the link is down. The smaller the number, the lower the "cost".

The metric sets the priority for the ZyWALL's routes to the Internet. If any two of the default routes have the same metric, the ZyWALL uses the following pre-defined priorities:

1. Normal route: designated by the ISP (see *section 8.5*) or a static route (see the IP Static Route Setup chapter)
2. Traffic-redirect route (see *section 8.8*)
3. Dial-backup route (see *section 8.9*)

For example, if the normal route has a metric of "1" and the traffic-redirect route has a metric of "2" and dial-backup route has a metric of "3", then the normal route acts as the primary default route. If the normal route fails to connect to the Internet, the ZyWALL tries the traffic-redirect route next. In the same manner, the ZyWALL uses the dial-backup route if the traffic-redirect route also fails.

If you want the dial-backup route to take first priority over the traffic-redirect route or even the normal route, all you need to do is set the dial-backup route's metric to "1" and the others to "2" (or greater).

8.3 Configuring Route

Click **WAN** to open the **Route** screen.

Figure 8-1 WAN Setup: Route

The following table describes the labels in this screen.

Table 8-1 WAN Setup: Route

LABEL	DESCRIPTION
WAN Traffic Redirect Dial Backup	The default WAN connection is "1" as your broadband connection via the WAN port should always be your preferred method of accessing the WAN. The default priority of the routes is WAN , Traffic Redirect and then Dial Backup (dial backup does not apply to all ZyWALL models): You have two choices for an auxiliary connection in the event that your regular WAN connection goes down. If Dial Backup is preferred to Traffic Redirect , then type "14" in the Dial Backup Priority (metric) field (and leave the Traffic Redirect Priority (metric) at the default of "15").
Apply	Click Apply to save your changes back to the ZyWALL.
Reset	Click Reset to begin configuring this screen afresh.

8.4 Configuring WAN ISP

To change your ZyWALL's WAN ISP settings, click **WAN**, then the **WAN ISP** tab. The screen differs by the encapsulation.

8.4.1 Ethernet Encapsulation

The screen shown next is for **Ethernet** encapsulation.

The screenshot shows the WAN configuration page with the 'WAN ISP' tab selected. The 'ISP Parameters for Internet Access' section contains the following fields:

- Encapsulation:** A dropdown menu set to 'Ethernet'.
- Service Type:** A dropdown menu set to 'RR-Toshiba'.
- User Name:** A text input field.
- Password:** A text input field with masked characters.
- Retype to Confirm:** A text input field with masked characters.
- Login Server IP Address:** A text input field containing '0.0.0.0'.

At the bottom of the form are 'Apply' and 'Reset' buttons.

Figure 8-2 Ethernet Encapsulation

The following table describes the labels in this screen.

Table 8-2 Ethernet Encapsulation

LABEL	DESCRIPTION
Encapsulation	You must choose the Ethernet option when the WAN port is used as a regular Ethernet.
Service Type	Choose from Standard , Telstra (RoadRunner Telstra authentication method), RR-Manager (Roadrunner Manager authentication method), RR-Toshiba (Roadrunner Toshiba authentication method) or Telia Login . The following fields do not appear with the Standard service type.
User Name	Type the user name given to you by your ISP.
Password	Type the password associated with the user name above.
Retype to Confirm	Type the password again to make sure that you have entered it correctly.
Login Server IP Address	Type the authentication server IP address here if your ISP gave you one.
Login Server	This field only applies when you select Telia Login in the Service Type field. Type the domain name of the Telia login server, for example "login1.telia.com".

Table 8-2 Ethernet Encapsulation

LABEL	DESCRIPTION
Relogin Every (min)	This field only applies when you select Telia Login in the Service Type field. The Telia server logs the ZyWALL out if the ZyWALL does not log in periodically. Type the number of minutes from 1 to 59 (30 default) for the ZyWALL to wait between logins.
Apply	Click Apply to save your changes back to the ZyWALL.
Reset	Click Reset to begin configuring this screen afresh.

8.4.2 PPPoE Encapsulation

The ZyWALL supports PPPoE (Point-to-Point Protocol over Ethernet). PPPoE is an IETF Draft standard (RFC 2516) specifying how a personal computer (PC) interacts with a broadband modem (DSL, cable, wireless, etc.) connection. The **PPPoE** option is for a dial-up connection using PPPoE.

For the service provider, PPPoE offers an access and authentication method that works with existing access control systems (for example Radius). PPPoE provides a login and authentication method that the existing Microsoft Dial-Up Networking software can activate, and therefore requires no new learning or procedures for Windows users.

One of the benefits of PPPoE is the ability to let you access one of multiple network services, a function known as dynamic service selection. This enables the service provider to easily create and offer new IP services for individuals.

Operationally, PPPoE saves significant effort for both you and the ISP or carrier, as it requires no specific configuration of the broadband modem at the customer site.

By implementing PPPoE directly on the ZyWALL (rather than individual computers), the computers on the LAN do not need PPPoE software installed, since the ZyWALL does that part of the task. Furthermore, with NAT, all of the LANs' computers will have access.

The screen shown next is for **PPPoE** encapsulation.

The screenshot shows the WAN configuration page with the following tabs: Route, WAN ISP (selected), WAN IP, WAN MAC, Traffic Redirect, and Dial Backup. The main section is titled "ISP Parameters for Internet Access" and contains the following fields:

- Encapsulation: A dropdown menu set to "PPPoE over Ethernet".
- Service Name: A text input field with "(Optional)" to its right.
- User Name: A text input field.
- Password: A text input field with masked characters.
- Retype to Confirm: A text input field with masked characters.
- Nailed-Up Connection: A checkbox.
- Idle Timeout: A text input field set to "100" with "(Seconds)" to its right.

At the bottom of the form are "Apply" and "Reset" buttons.

Figure 8-3 PPPoE Encapsulation

The following table describes the labels in this screen.

Table 8-3 PPPoE Encapsulation

LABEL	DESCRIPTION
ISP Parameters for Internet Access	
Encapsulation	The PPPoE choice is for a dial-up connection using PPPoE. The router supports PPPoE (Point-to-Point Protocol over Ethernet). PPPoE is an IETF Draft standard (RFC 2516) specifying how a personal computer (PC) interacts with a broadband modem (i.e. xDSL, cable, wireless, etc.) connection. Operationally, PPPoE saves significant effort for both the end user and ISP/carrier, as it requires no specific configuration of the broadband modem at the customer site. By implementing PPPoE directly on the router rather than individual computers, the computers on the LAN do not need PPPoE software installed, since the router does that part of the task. Further, with NAT, all of the LAN's computers will have access.
Service Name	Type the PPPoE service name provided to you. PPPoE uses a service name to identify and reach the PPPoE server.
User Name	Type the user name given to you by your ISP.
Password	Type the password associated with the User Name above.

Table 8-3 PPPoE Encapsulation

LABEL	DESCRIPTION
Retype to Confirm	Type your password again to make sure that you have entered it correctly.
Nailed-Up Connection	Select Nailed-Up Connection if you do not want the connection to time out.
Idle Timeout	This value specifies the time in seconds that elapses before the router automatically disconnects from the PPPoE server.
Apply	Click Apply to save your changes back to the ZyWALL.
Reset	Click Reset to begin configuring this screen afresh.

8.4.3 PPTP Encapsulation

Point-to-Point Tunneling Protocol (PPTP) is a network protocol that enables secure transfer of data from a remote client to a private server, creating a Virtual Private Network (VPN) using TCP/IP-based networks. PPTP supports on-demand, multi-protocol and virtual private networking over public networks, such as the Internet.

The screen shown next is for **PPTP** encapsulation.

The screenshot shows the WAN configuration page with the 'WAN ISP' tab selected. The 'ISP Parameters for Internet Access' section includes a dropdown for 'Encapsulation' set to 'PPTP', text boxes for 'User Name', 'Password', and 'Retype to Confirm', a checkbox for 'Nailed-Up Connection', and a numeric field for 'Idle Timeout' set to '100'. The 'PPTP Configuration' section includes text boxes for 'My IP Address', 'My IP Subnet Mask', and 'Server IP Address', all set to '0.0.0.0', and a text box for 'Connection ID/Name'. 'Apply' and 'Reset' buttons are at the bottom.

Figure 8-4 PPTP Encapsulation

The following table describes the labels in this screen.

Table 8-4 PPTP Encapsulation

LABEL	DESCRIPTION
ISP Parameters for Internet Access	
Encapsulation	Point-to-Point Tunneling Protocol (PPTP) is a network protocol that enables secure transfer of data from a remote client to a private server, creating a Virtual Private Network (VPN) using TCP/IP-based networks. PPTP supports on-demand, multi-protocol, and virtual private networking over public networks, such as the Internet. The ZyWALL supports only one PPTP server connection at any given time. To configure a PPTP client, you must configure the User Name and Password fields for a PPP connection and the PPTP parameters for a PPTP connection.
User Name	Type the user name given to you by your ISP.
Password	Type the password associated with the User Name above.

Table 8-4 PPTP Encapsulation

LABEL	DESCRIPTION
Retype to Confirm	Type your password again to make sure that you have entered it correctly.
Nailed-up Connection	Select Nailed-Up Connection if you do not want the connection to time out.
Idle Timeout	This value specifies the time in seconds that elapses before the ZyWALL automatically disconnects from the PPTP server.
PPTP Configuration	
My IP Address	Type the (static) IP address assigned to you by your ISP.
My IP Subnet Mask	Your ZyWALL will automatically calculate the subnet mask based on the IP address that you assign. Unless you are implementing subnetting, use the subnet mask computed by the ZyWALL.
Server IP Address	Type the IP address of the PPTP server.
Connection ID/Name	Type your identification name for the PPTP server.
Apply	Click Apply to save your changes back to the ZyWALL.
Reset	Click Reset to begin configuring this screen afresh.

8.5 Configuring WAN IP

To change your ZyWALL's WAN IP settings, click **WAN**, then the **WAN IP** tab. This screen varies according to the type of encapsulation you select.

If your ISP did *not* assign you a fixed IP address, click **Get automatically from ISP (Default)**; otherwise click **Use fixed IP Address** and enter the IP address in the following field.

Figure 8-5 IP Setup

The following table describes the labels in this screen.

Table 8-5 IP Setup

LABEL	DESCRIPTION
WAN IP Address Assignment	
Get automatically from ISP	Select this option If your ISP did not assign you a fixed IP address. This is the default selection.
Use fixed IP address	Select this option If the ISP assigned a fixed IP address.
IP Address	Enter your WAN IP address in this field if you selected Use Fixed IP Address .
IP Subnet Mask	Enter the IP subnet mask (if your ISP gave you one) in this field if you selected Use Fixed IP Address .

Table 8-5 IP Setup

LABEL	DESCRIPTION
Gateway IP Address	Enter the gateway IP address (if your ISP gave you one) in this field if you selected Use Fixed IP Address .
Network Address Translation	<p>Network Address Translation (NAT) allows the translation of an Internet protocol address used within one network (for example a private IP address used in a local network) to a different IP address known within another network (for example a public IP address used on the Internet).</p> <p>Choose None to disable NAT.</p> <p>Choose SUA Only if you have a single public IP address. SUA (Single User Account) is a subset of NAT that supports two types of mapping: Many-to-One and Server.</p> <p>Choose Full Feature if you have multiple public IP addresses. Full Feature mapping types include: One-to-One, Many-to-One (SUA/PAT), Many-to-Many Overload, Many- One-to-One and Server. When you select Full Feature you must configure at least one address mapping set!</p> <p>For more information about NAT refer to the <i>NAT</i> chapter in this <i>User's Guide</i>.</p>
Metric (PPPoE and PPTP only)	<p>This field sets this route's priority among the routes the ZyWALL uses.</p> <p>The metric represents the "cost of transmission". A router determines the best route for transmission by choosing a path with the lowest "cost". RIP routing uses hop count as the measurement of cost, with a minimum of "1" for directly connected networks. The number must be between "1" and "15"; a number greater than "15" means the link is down. The smaller the number, the lower the "cost".</p>
Private (PPPoE and PPTP only)	This parameter determines if the ZyWALL will include the route to this remote node in its RIP broadcasts. If set to Yes, this route is kept private and not included in RIP broadcast. If No, the route to this remote node will be propagated to other hosts through RIP broadcasts.
RIP Direction	<p>RIP (Routing Information Protocol) allows a router to exchange routing information with other routers. The RIP Direction field controls the sending and receiving of RIP packets.</p> <p>Choose Both, None, In Only or Out Only.</p> <p>When set to Both or Out Only, the ZyWALL will broadcast its routing table periodically.</p> <p>When set to Both or In Only, the ZyWALL will incorporate RIP information that it receives.</p> <p>When set to None, the ZyWALL will not send any RIP packets and will ignore any RIP packets received.</p> <p>By default, RIP Direction is set to Both.</p>

Table 8-5 IP Setup

LABEL	DESCRIPTION
RIP Version	<p>The RIP Version field controls the format and the broadcasting method of the RIP packets that the ZyWALL sends (it recognizes both formats when receiving).</p> <p>Choose RIP-1, RIP-2B or RIP-2M.</p> <p>RIP-1 is universally supported; but RIP-2 carries more information. RIP-1 is probably adequate for most networks, unless you have an unusual network topology. Both RIP-2B and RIP-2M sends the routing data in RIP-2 format; the difference being that RIP-2B uses subnet broadcasting while RIP-2M uses multicasting. Multicasting can reduce the load on non-router machines since they generally do not listen to the RIP multicast address and so will not receive the RIP packets. However, if one router uses multicasting, then all routers on your network must use multicasting, also. By default, the RIP Version field is set to RIP-1.</p>
Multicast	<p>Choose None (default), IGMP-V1 or IGMP-V2. IGMP (Internet Group Multicast Protocol) is a network-layer protocol used to establish membership in a Multicast group - it is not used to carry user data. IGMP version 2 (RFC 2236) is an improvement over version 1 (RFC 1112) but IGMP version 1 is still in wide use. If you would like to read more detailed information about interoperability between IGMP version 2 and version 1, please see sections 4 and 5 of RFC 2236.</p>
Windows Networking (NetBIOS over TCP/IP): NetBIOS (Network Basic Input/Output System) are TCP or UDP broadcast packets that enable a computer to connect to and communicate with a LAN. For some dial-up services such as PPPoE or PPTP, NetBIOS packets cause unwanted calls.	
Allow From WAN to LAN	Select this option to forward NetBIOS packets from the WAN port to the LAN port.
Allow From WAN to DMZ	Select this option to forward NetBIOS packets from the WAN port to the DMZ port. (Not all ZyWALL models have a DMZ port.)
Allow Trigger Dial	Select this option to allow NetBIOS packets to initiate calls.
Apply	Click Apply to save your changes back to the ZyWALL.
Reset	Click Reset to begin configuring this screen afresh.

8.6 Configuring WAN MAC

To change your ZyWALL's WAN MAC settings, click **WAN**, then the **WAN MAC** tab. The screen appears as shown.



Figure 8-6 MAC Setup

The MAC address screen allows users to configure the WAN port's MAC Address by either using the factory default or cloning the MAC address from a computer on your LAN. Choose **Factory Default** to select the factory assigned default MAC Address.

Otherwise, click **Spoof this computer's MAC address - IP Address** and enter the IP address of the computer on the LAN whose MAC you are cloning. Once it is successfully configured, the address will be copied to the rom file (ZyNOS configuration file). It will not change unless you change the setting or upload a different ROM file.

8.7 Traffic Redirect

Traffic redirect forwards WAN traffic to a backup gateway when the ZyWALL cannot connect to the Internet through its normal gateway. Connect the backup gateway on the WAN so that the ZyWALL still provides firewall protection. This feature is not available on all models.

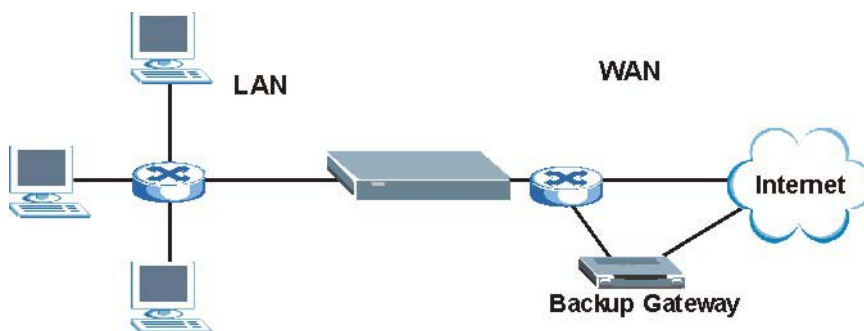

Figure 8-7 Traffic Redirect WAN Setup

The following network topology allows you to avoid triangle route security issues (see the *Appendices*) when the backup gateway is connected to the LAN or DMZ. Use IP alias to configure the LAN into two or three logical networks with the ZyWALL itself as the gateway for each LAN network. Put the protected LAN in one subnet (Subnet 1 in the following figure) and the backup gateway in another subnet (Subnet 2). Configure a LAN to LAN/ZyWALL firewall rule that forwards packets from the protected LAN (Subnet 1) to the backup gateway (Subnet 2).

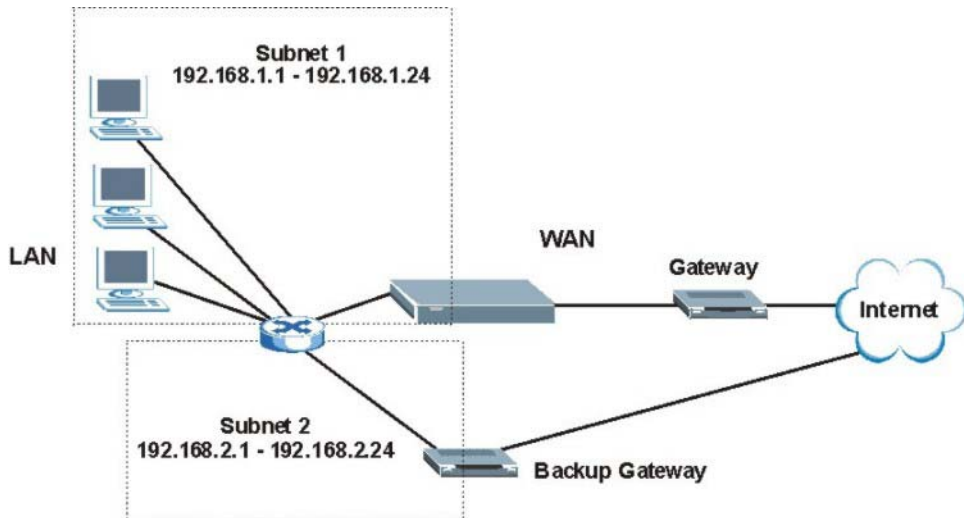

Figure 8-8 Traffic Redirect LAN Setup

8.8 Configuring Traffic Redirect

To change your ZyWALL's Traffic Redirect settings, click **WAN**, then the **Traffic Redirect** tab. The screen appears as shown.

The screenshot shows the 'WAN' configuration page with the 'Traffic Redirect' tab selected. The configuration options are as follows:

Field	Value	Unit
Active	<input type="checkbox"/>	
Backup Gateway IP Address	0.0.0.0	
Metric	14	
Check WAN IP Address	0.0.0.0	
Fall Tolerance	2	
Period	5	(Seconds)
Timeout	3	(Seconds)

Figure 8-9 Traffic Redirect

The following table describes the labels in this screen.

Table 8-6 Traffic Redirect

LABEL	DESCRIPTION
Active	Select this check box to have the ZyWALL use traffic redirect if the normal WAN connection goes down.
Backup Gateway IP Address	Type the IP address of your backup gateway in dotted decimal notation. The ZyWALL automatically forwards traffic to this IP address if the ZyWALL's Internet connection terminates.
Metric	This field sets this route's priority among the routes the ZyWALL uses. The metric represents the "cost of transmission". A router determines the best route for transmission by choosing a path with the lowest "cost". RIP routing uses hop count as the measurement of cost, with a minimum of "1" for directly connected networks. The number must be between "1" and "15"; a number greater than "15" means the link is down. The smaller the number, the lower the "cost".
Check WAN IP Address	Configuration of this field is optional. If you do not enter an IP address here, the ZyWALL will use the default gateway IP address. Configure this field to test your ZyWALL's WAN accessibility. Type the IP address of a reliable nearby computer (for example, your ISP's DNS server address). If you are using PPTP or PPPoE Encapsulation, type "0.0.0.0" to configure the ZyWALL to check the PVC (Permanent Virtual Circuit) or PPTP tunnel.

Table 8-6 Traffic Redirect

LABEL	DESCRIPTION
Fail Tolerance	Type the number of times your ZyWALL may attempt and fail to connect to the Internet before traffic is forwarded to the backup gateway.
Period (sec)	Type the number of seconds for the ZyWALL to wait between checks to see if it can connect to the WAN IP address (Check WAN IP Address field) or default gateway. Allow more time if your destination IP address handles lots of traffic.
Timeout (sec)	Type the number of seconds for your ZyWALL to wait for a ping response from the IP Address in the Check WAN IP Address field before it times out. The WAN connection is considered "down" after the ZyWALL times out the number of times specified in the Fail Tolerance field. Use a higher value in this field if your network is busy or congested.
Apply	Click Apply to save your changes back to the ZyWALL.
Reset	Click Reset to begin configuring this screen afresh.

8.9 Configuring Dial Backup

To change your ZyWALL's Dial Backup settings, click **WAN**, then the **Dial Backup** tab. The screen appears as shown.

WAN

Route WAN ISP WAN IP WAN MAC **Traffic Redirect** Dial Backup

Enable Dial Backup

Basic Settings

Login Name

Password

Retype to Confirm

Authentication Type

Primary Phone Number

Secondary Phone Number Optional

Dial Backup Port Speed

AT Command Initial String

Advanced Modem Setup

TCP/IP Options

Priority (Metric) 1(Highest) ~ 15(Lowest)

Get IP Address Automatically from Remote Server

Use Fixed IP Address

My WAN IP Address

Remote IP Subnet Mask

Remote Node IP Address

Enable SUA

Enable RIP

RIP Version

RIP Direction

Broadcast Dial Backup Route

Enable Multicast

Multicast Version

PPP Options

PPP Encapsulation

Enable Compression

Budget

Always On

Configure Budget

Allocated Budget minutes

Period Hours

Idle Timeout Seconds

Figure 8-10 Dial Backup Setup

The following table describes the labels in this screen.

Table 8-7Dial Backup Setup

LABEL	DESCRIPTION
Enable Dial Backup	Select this check box to turn on dial backup.
Basic Settings	
Login Name	Type the login name assigned by your ISP.
Password	Type the password assigned by your ISP.
Retype to Confirm	Type your password again to make sure that you have entered it correctly.
Authentication Type	<p>Use the drop-down list box to select an authentication protocol for outgoing calls. Options are:</p> <p>CHAP/PAP - Your ZyWALL accepts either CHAP or PAP when requested by this remote node.</p> <p>CHAP - Your ZyWALL accepts CHAP only.</p> <p>PAP - Your ZyWALL accept PAP only.</p>
Primary/ Secondary Phone Number	Type the first (primary) phone number from the ISP for this remote node. If the Primary Phone number is busy or does not answer, your ZyWALL dials the Secondary Phone number if available. Some areas require dialing the pound sign # before the phone number for local calls. Include a # symbol at the beginning of the phone numbers as required.
Dial Backup Port Speed	Use the drop-down list box to select the speed of the connection between the Dial Backup port and the external device. Available speeds are: 9600, 19200, 38400, 57600, 115200 or 230400 bps.
AT Command Initial String	Type the AT command string to initialize the WAN device. Consult the manual of your WAN device connected to your Dial Backup port for specific AT commands.
Advanced Modem Setup	Click this button to display the Advanced Setup screen and edit the details of your dial backup setup.
TCP/IP Options	
Priority (Metric)	<p>This field sets this route's priority among the three routes the ZyWALL uses (normal, traffic redirect and dial backup). Type a number (1 to 15) to set the priority of the dial backup route for data transmission. The smaller the number, the higher the priority.</p> <p>If the three routes have the same metrics, the priority of the routes is as follows: WAN, Traffic Redirect, Dial Backup.</p>

Table 8-7Dial Backup Setup

LABEL	DESCRIPTION
Get IP Address Automatically from Remote Server	Type the login name assigned by your ISP for this remote node.
Used Fixed IP Address	Select this check box if your ISP assigned you a fixed IP address, then enter the IP address in the following field.
ZyWALL WAN IP Address	Leave the field set to 0.0.0.0 (default) to have the ISP or other remote router dynamically (automatically) assign your WAN IP address if you do not know it. Type your WAN IP address here if you know it (static). This is the address assigned to your local ZyWALL, not the remote router.
Remote IP Subnet Mask	Leave this field set to 0.0.0.0 (default) to have the ISP or other remote router dynamically send its subnet mask if you do not know it. Type the remote gateway's subnet mask here if you know it (static).
Remote Node IP Address	Leave this field set to 0.0.0.0 (default) to have the ISP or other remote router dynamically (automatically) send its IP address if you do not know it. Type the remote gateway's IP address here if you know it (static).
Enable SUA	<p>Network Address Translation (NAT) allows the translation of an Internet protocol address used within one network to a different IP address known within another network.</p> <p>SUA (Single User Account) is a subset of NAT that supports two types of mapping: Many-to-One and Server. When you select this option the ZyWALL will use Address Mapping Set 255 in the SMT (see the section on menu 15.1 for more information).</p> <p>Select the check box to enable SUA. Clear the check box to disable SUA so the ZyWALL does not perform any NAT mapping for the dial backup connection.</p>
Enable RIP	Select this check box to turn on RIP (Routing Information Protocol), which allows a router to exchange routing information with other routers.

Table 8-7Dial Backup Setup

LABEL	DESCRIPTION
RIP Version	<p>The RIP Version field controls the format and the broadcasting method of the RIP packets that the ZyWALL sends (it recognizes both formats when receiving). Choose RIP-1, RIP-2B or RIP-2M.</p> <p>RIP-1 is universally supported; but RIP-2 carries more information. RIP-1 is probably adequate for most networks, unless you have an unusual network topology. Both RIP-2B and RIP-2M sends the routing data in RIP-2 format; the difference being that RIP-2B uses subnet broadcasting while RIP-2M uses multicasting. Multicasting can reduce the load on non-router machines since they generally do not listen to the RIP multicast address and so will not receive the RIP packets. However, if one router uses multicasting, then all routers on your network must use multicasting, also.</p>
RIP Direction	<p>RIP (Routing Information Protocol) allows a router to exchange routing information with other routers. The RIP Direction field controls the sending and receiving of RIP packets.</p> <p>Choose Both, In Only or Out Only.</p> <p>When set to Both or Out Only, the ZyWALL will broadcast its routing table periodically.</p> <p>When set to Both or In Only, the ZyWALL will incorporate RIP information that it receives.</p>
Broadcast Dial Backup Route	Select this check box to forward the backup route broadcasts to the WAN.
Enable Multicast	Select this check box to turn on IGMP (Internet Group Multicast Protocol). IGMP is a network-layer protocol used to establish membership in a Multicast group - it is not used to carry user data.
Multicast Version	Select IGMP-v1 or IGMP-v2 . IGMP version 2 (RFC 2236) is an improvement over version 1 (RFC 1112) but IGMP version 1 is still in wide use. If you would like to read more detailed information about interoperability between IGMP version 2 and version 1, please see <i>sections 4 and 5 of RFC 2236</i> .
PPP Options	
PPP Encapsulation	Select CISCO PPP from the drop-down list box if your dial backup WAN device uses Cisco PPP encapsulation, otherwise select Standard PPP .
Enable Compression	Select this check box to turn on stac compression.
Budget	
Always On	Select this check box to have the dial backup connection on all of the time.

Table 8-7Dial Backup Setup

LABEL	DESCRIPTION
Configure Budget	Select this check box to have the dial backup connection on during the time that you select.
Allocated Budget	Type the amount of time (in minutes) that the dial backup connection can be used during the time configured in the Period field. Set an amount that is less than the time period configured in the Period field.
Period	Type the time period (in hours) for how often the budget should be reset. For example, to allow calls to this remote node for a maximum of 10 minutes every hour, set the Allocated Budget to 10 (minutes) and the Period to 1 (hour).
Idle Timeout	Type the number of seconds of idle time (when there is no traffic from the ZyWALL to the remote node) for the ZyWALL to wait before it automatically disconnects the dial backup connection. This option applies only when the ZyWALL initiates the call. The dial backup connection never times out if you set this field to "0" (it is the same as selecting Always On).
Apply	Click Apply to save your changes back to the ZyWALL.
Reset	Click Reset to begin configuring this screen afresh.

8.10 Advanced Modem Setup

8.10.1 AT Command Strings

For regular telephone lines, the default "Dial" string tells the modem that the line uses tone dialing. "ATDT" is the command for a switch that requires tone dialing. If your switch requires pulse dialing, change the string to "ATDP".

For ISDN lines, there are many more protocols and operational modes. Please consult the documentation of your TA. You may need additional commands in both "Dial" and "Init" strings.

8.10.2 DTR Signal

The majority of WAN devices default to hanging up the current call when the DTR (Data Terminal Ready) signal is dropped by the DTE. When the "Drop DTR When Hang Up" check box is selected, the ZyWALL uses this hardware signal to force the WAN device to hang up, in addition to issuing the drop command "ATH".

8.10.3 Response Strings

The response strings tell the ZyWALL the tags, or labels, immediately preceding the various call parameters sent from the WAN device. The response strings have not been standardized; please consult the documentation of your WAN device to find the correct tags.

8.11 Configuring Advanced Modem Setup

Click the **Edit** button in the **Dial Backup** screen to display the **Advanced Setup** screen shown next.

Consult the manual of your WAN device connected to your dial backup port for specific AT commands.

The screenshot shows the 'ADVANCED SETUP' configuration screen. It is divided into three main sections:

- AT Command Strings:**
 - Dial: atdt
 - Drop: atdt +++ ATDT gth
 - Answer: atd
 - Drop DTR When Hang Up
- AT Response Strings:**
 - CLID: NUMBER
 - Called ID: (empty field)
 - Speed: CONNECT
- Call Control:**
 - Dial Timeout (sec): 60
 - Retry Count: 0
 - Retry Interval (sec): 10
 - Drop Timeout (sec): 20
 - Call Back Delay (sec): 15

At the bottom of the screen, there are two buttons: 'Apply' and 'Cancel'.

Figure 8-11 Advanced Setup

The following table describes the labels in this screen.

Table 8-8 Advanced Setup

LABEL	DESCRIPTION	EXAMPLE
AT Command Strings		
Dial	Type the AT Command string to make a call.	atdt
Drop	Type the AT Command string to drop a call. "~" represents a one second wait, for example, "~+++~ath" can be used if your modem has a slow response time.	~+++~ath
Answer	Type the AT Command string to answer a call.	ata
Drop DTR When Hang Up	Select this check box to have the ZyWALL drop the DTR (Data Terminal Ready) signal after the "AT Command String: Drop" is sent out.	
AT Response Strings		
CLID	Type the keyword that precedes the CLID (Calling Line Identification) in the AT response string. This lets the ZyWALL capture the CLID in the AT response string that comes from the WAN device. CLID is required for CLID authentication.	NMBR
Called ID	Type the keyword preceding the dialed number.	
Speed	Type the keyword preceding the connection speed.	CONNECT
Call Control		
Dial Timeout (sec)	Type a number of seconds for the ZyWALL to try to set up an outgoing call before timing out (stopping).	60
Retry Count	Type a number of times for the ZyWALL to retry a busy or no-answer phone number before blacklisting the number.	0
Retry Interval (sec)	Type a number of seconds for the ZyWALL to wait before trying another call after a call has failed. This applies before a phone number is blacklisted.	10
Drop Timeout (sec)	Type the number of seconds for the ZyWALL to wait before dropping the DTR signal if it does not receive a positive disconnect confirmation.	20
Call Back Delay (sec)	Type a number of seconds for the ZyWALL to wait between dropping a callback request call and dialing the corresponding callback call.	15

Table 8-8 Advanced Setup

LABEL	DESCRIPTION	EXAMPLE
Apply	Click Apply to save your changes back to the ZyWALL.	
Reset	Click Reset to begin configuring this screen afresh.	

Part IV:

NAT and Static Route

This part covers Network Address Translation and setting up static routes.

Chapter 9

Network Address Translation (NAT)

Screens

This chapter discusses how to configure NAT on the ZyWALL.

9.1 NAT Overview

NAT (Network Address Translation - NAT, RFC 1631) is the translation of the IP address of a host in a packet. For example, the source address of an outgoing packet, used within one network is changed to a different IP address known within another network.

9.1.1 NAT Definitions

Inside/outside denotes where a host is located relative to the ZyWALL. For example, the computers of your subscribers are the inside hosts, while the web servers on the Internet are the outside hosts.

Global/local denotes the IP address of a host in a packet as the packet traverses a router. For example, the local address refers to the IP address of a host when the packet is in the local network, while the global address refers to the IP address of the host when the same packet is traveling in the WAN side.

Note that inside/outside refers to the location of a host, while global/local refers to the IP address of a host used in a packet. Thus, an inside local address (ILA) is the IP address of an inside host in a packet when the packet is still in the local network, while an inside global address (IGA) is the IP address of the same inside host when the packet is on the WAN side. The following table summarizes this information.

Table 9-1 NAT Definitions

TERM	DESCRIPTION
Inside	This refers to the host on the LAN.
Outside	This refers to the host on the WAN.
Local	This refers to the packet address (source or destination) as the packet travels on the LAN.
Global	This refers to the packet address (source or destination) as the packet travels on the WAN.

NAT never changes the IP address (either local or global) of an outside host.

9.1.2 What NAT Does

In the simplest form, NAT changes the source IP address in a packet received from a subscriber (the inside local address) to another (the inside global address) before forwarding the packet to the WAN side. When the response comes back, NAT translates the destination address (the inside global address) back to the inside local address before forwarding it to the original inside host. Note that the IP address (either local or global) of an outside host is never changed.

The global IP addresses for the inside hosts can be either static or dynamically assigned by the ISP. In addition, you can designate servers (for example a web server and a telnet server) on your local network and make them accessible to the outside world. Although you can make designated servers on the LAN accessible to the outside world, it is strongly recommended that you attach those servers to the DMZ port instead. If you do not define any servers (for Many-to-One and Many-to-Many Overload mapping), NAT offers the additional benefit of firewall protection. With no servers defined, your ZyWALL filters out all incoming inquiries, thus preventing intruders from probing your network. For more information on IP address translation, refer to *RFC 1631, The IP Network Address Translator (NAT)*.

9.1.3 How NAT Works

Each packet has two addresses – a source address and a destination address. For outgoing packets, the ILA (Inside Local Address) is the source address on the LAN, and the IGA (Inside Global Address) is the source address on the WAN. For incoming packets, the ILA is the destination address on the LAN, and the IGA is the destination address on the WAN. NAT maps private (local) IP addresses to globally unique ones required for communication with hosts on other networks. It replaces the original IP source address (and TCP or UDP source port numbers for Many-to-One and Many-to-Many Overload NAT mapping) in each packet and then forwards it to the Internet. The ZyWALL keeps track of the original addresses and port numbers so incoming reply packets can have their original values restored. The following figure illustrates this.

Table 9-2 NAT Table Example

INSIDE LOCAL IP ADDRESS	INSIDE GLOBAL IP ADDRESS
192.168.1.10	IGA 1
192.168.1.11	IGA 2
192.168.1.12	IGA 3
192.168.1.13	IGA 4

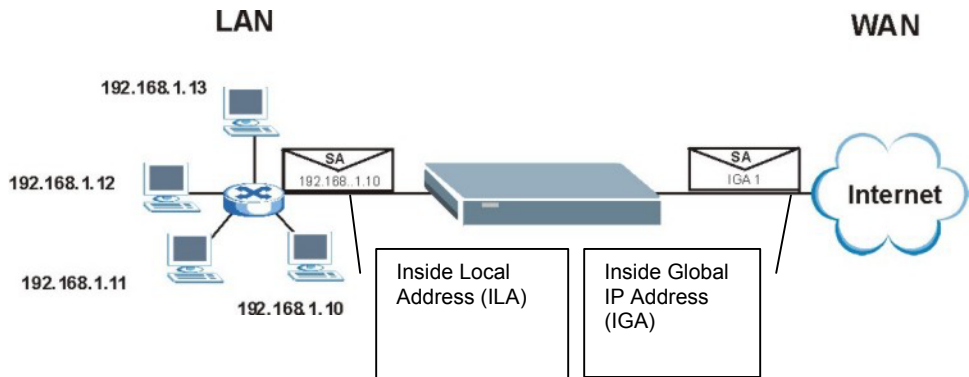

Figure 9-1 How NAT Works

9.1.4 NAT Application

The following figure illustrates a possible NAT application, where three inside LANs (logical LANs using IP Alias) behind the ZyWALL can communicate with three distinct WAN networks. More examples follow at the end of this chapter.

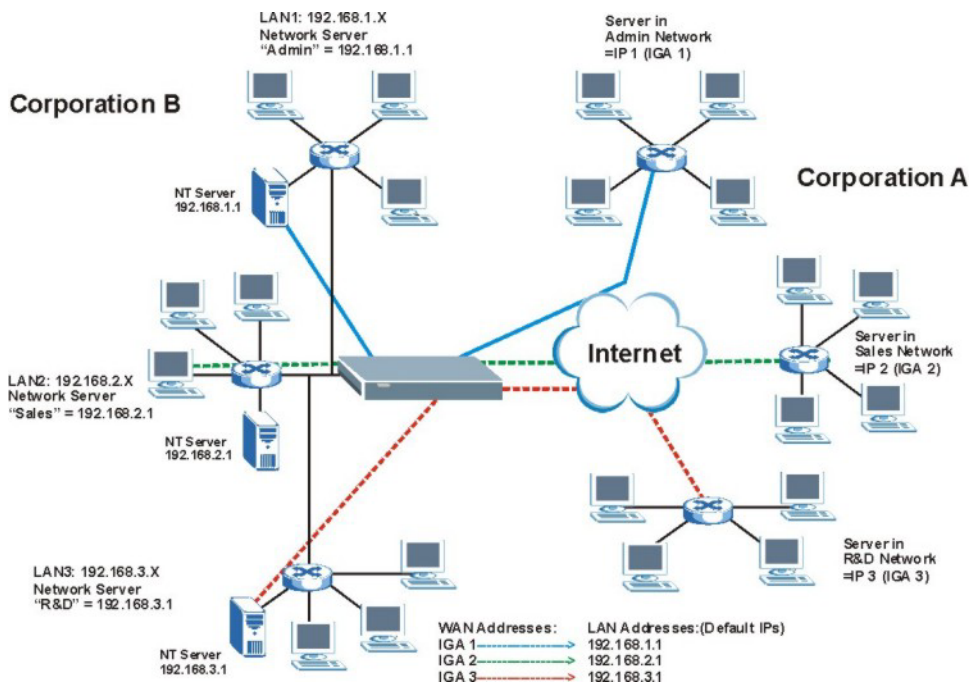

Figure 9-2 NAT Application With IP Alias

9.1.5 NAT Mapping Types

NAT supports five types of IP/port mapping. They are:

- **One to One:** In One-to-One mode, the ZyWALL maps one local IP address to one global IP address.
- **Many to One:** In Many-to-One mode, the ZyWALL maps multiple local IP addresses to one global IP address. This is equivalent to SUA (i.e., PAT, port address translation), ZyXEL's Single User Account feature (the SUA Only option).
- **Many to Many Overload:** In Many-to-Many Overload mode, the ZyWALL maps the multiple local IP addresses to shared global IP addresses.
- **Many One to One:** In Many-One-to-One mode, the ZyWALL maps each local IP address to a unique global IP address.

- **Server:** This type allows you to specify inside servers of different services behind the NAT to be accessible to the outside world although, it is highly recommended that you use the DMZ port for these servers instead.

Port numbers do not change for One-to-One and Many-One-to-One NAT mapping types.

The following table summarizes these types.

Table 9-3 NAT Mapping Types

TYPE	IP MAPPING	SMT ABBREVIATION
One-to-One	ILA1↔ IGA1	1-1
Many-to-One (SUA/PAT)	ILA1↔ IGA1 ILA2↔ IGA1 ...	M-1
Many-to-Many Overload	ILA1↔ IGA1 ILA2↔ IGA2 ILA3↔ IGA1 ILA4↔ IGA2 ...	M-M Ov
Many-One-to-One	ILA1↔ IGA1 ILA2↔ IGA2 ILA3↔ IGA3 ...	M-1-1
Server	Server 1 IP↔ IGA1 Server 2 IP↔ IGA1 Server 3 IP↔ IGA1	Server

9.2 Using NAT

You must create a firewall rule in addition to setting up SUA/NAT, to allow traffic from the WAN to be forwarded through the ZyWALL.

9.2.1 SUA (Single User Account) Versus NAT

SUA (Single User Account) is a ZyNOS implementation of a subset of NAT that supports two types of mapping, **Many-to-One** and **Server**. The ZyWALL also supports **Full Feature** NAT to map multiple global

IP addresses to multiple private LAN IP addresses of clients or servers using mapping types. Select either **SUA Only** or **Full Feature** in **WAN IP**.

Selecting **SUA Only** means (latent) multiple WAN-to-LAN and WAN-to-DMZ multiple address translation. That means that computers on your DMZ with public IP addresses will still have to undergo NAT mapping if you're using **SUA Only** NAT mapping. If this is not your intention, then select **Full Feature** NAT and don't configure NAT mapping rules to those computers with public IP addresses on the DMZ.

9.3 SUA Server

A SUA server set is a list of inside (behind NAT on the LAN) servers, for example, web or FTP, that you can make visible to the outside world even though SUA makes your whole inside network appear as a single computer to the outside world. The DMZ port provides additional safety for connecting your publicly accessible servers. This makes the LAN more secure by physically separating it from your public servers.

You may enter a single port number or a range of port numbers to be forwarded, and the local IP address of the desired server. The port number identifies a service; for example, web service is on port 80 and FTP on port 21. In some cases, such as for unknown services or where one server can support more than one service (for example both FTP and web service), it might be better to specify a range of port numbers. You can allocate a server IP address that corresponds to a port or a range of ports.

Many residential broadband ISP accounts do not allow you to run any server processes (such as a Web or FTP server) from your location. Your ISP may periodically check for servers and may suspend your account if it discovers any active services at your location. If you are unsure, refer to your ISP.

9.3.1 Default Server IP Address

If you do not assign a Default Server IP Address, the ZyWALL discards all packets received for ports that are not specified here or in the remote management setup.

In addition to the servers for specified services, NAT supports a default server IP address. A default server receives packets from ports that are not specified in this screen.

9.3.2 Port Forwarding: Services and Port Numbers

The most often used port numbers are shown in the following table. Please refer to RFC 1700 for further information about port numbers. Please also refer to the Supporting CD for more examples and details on SUA/NAT.

Table 9-4 Services and Port Numbers

SERVICES	PORT NUMBER
ECHO	7

Table 9-4 Services and Port Numbers

SERVICES	PORT NUMBER
FTP (File Transfer Protocol)	21
SMTP (Simple Mail Transfer Protocol)	25
DNS (Domain Name System)	53
Finger	79
HTTP (Hyper Text Transfer protocol or WWW, Web)	80
POP3 (Post Office Protocol)	110
NNTP (Network News Transport Protocol)	119
SNMP (Simple Network Management Protocol)	161
SNMP trap	162
PPTP (Point-to-Point Tunneling Protocol)	1723

9.3.3 Configuring Servers Behind SUA (Example)

Let's say you want to assign ports 21-25 to one server (A in the example), port 80 to another (B in the example) and assign a default server IP address of 192.168.1.35 to a third (C in the example). You assign the LAN IP addresses and the ISP assigns the WAN IP address. The NAT network appears as a single host on the Internet.

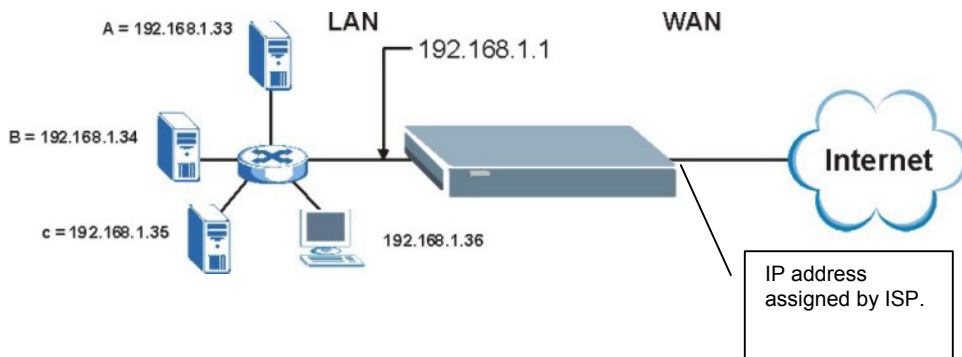

Figure 9-3 Multiple Servers Behind NAT Example

9.4 Configuring SUA Server

If you do not assign a Default Server IP Address, the ZyWALL discards all packets received for ports that are not specified in this screen or remote management.

Click **SUA/NAT** to open the **SUA Server** screen.

Refer to *Table 9-4* for port numbers commonly used for particular services.

SUA/NAT

SUA Server **Addr Mapping** Trigger Port

Default Server 0.0.0.0

#	Active	Name	Start Port	End Port	Server IP Address
1	<input type="checkbox"/>		0	0	0.0.0.0
2	<input type="checkbox"/>		0	0	0.0.0.0
3	<input type="checkbox"/>		0	0	0.0.0.0
4	<input type="checkbox"/>		0	0	0.0.0.0
5	<input type="checkbox"/>		0	0	0.0.0.0
6	<input type="checkbox"/>		0	0	0.0.0.0
7	<input type="checkbox"/>		0	0	0.0.0.0
8	<input type="checkbox"/>		0	0	0.0.0.0
9	<input type="checkbox"/>		0	0	0.0.0.0
10	<input type="checkbox"/>		0	0	0.0.0.0

Apply Reset

Figure 9-4 SUA Server

The following table describes the labels in this screen.

Table 9-5 SUA Server

LABEL	DESCRIPTION
Default Server	In addition to the servers for specified services, NAT supports a default server. A default server receives packets from ports that are not specified in this screen. If you do not assign a default server IP address, then all packets received for ports not specified in this screen or remote management will be discarded.
#	Number of an individual SUA server entry.
Active	Select this check box to enable the SUA server entry. Clear this checkbox to disallow forwarding of these ports to an inside server without having to delete the entry.
Name	Enter a name to identify this port-forwarding rule.
Start Port	Enter a port number here. To forward only one port, enter it again in the End Port field.
End Port	To specify a range of ports, enter the last port to be forwarded in the End Port field.

Table 9-5 SUA Server

LABEL	DESCRIPTION
Server IP Address	Enter the inside IP address of the server here.
Apply	Click Apply to save your changes back to the ZyWALL.
Reset	Click Reset to begin configuring this screen afresh.

9.5 Configuring Address Mapping

Ordering your rules is important because the ZyWALL applies the rules in the order that you specify. When a rule matches the current packet, the ZyWALL takes the corresponding action and the remaining rules are ignored. If there are any empty rules before your new configured rule, your configured rule will be pushed up by that number of empty rules. For example, if you have already configured rules 1 to 6 in your current set and now you configure rule number 9. In the set summary screen, the new rule will be rule 7, not 9. Now if you delete rule 4, rules 5 to 7 will be pushed up by 1 rule, so old rules 5, 6 and 7 become new rules 4, 5 and 6.

To change your ZyWALL's Address Mapping settings, click **SUA/NAT**, then the **Address Mapping** tab. The screen appears as shown.

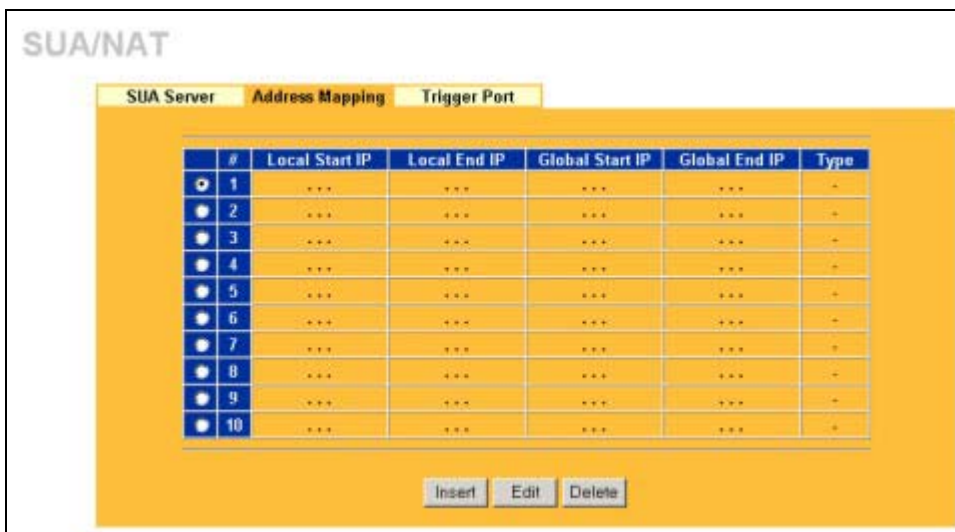
**Figure 9-5 Address Mapping**

The following table describes the labels in this screen.

Table 9-6 Address Mapping

LABEL	DESCRIPTION
Local Start IP	This refers to the Inside Local Address (ILA), which is the starting local IP address. If the rule is for all local IP addresses, then this field displays 0.0.0.0 as the Local Start IP address. Local IP addresses are N/A for Server port mapping.
Local End IP	This is the end Inside Local Address (ILA). If the rule is for all local IP addresses, then this field displays 255.255.255.255 as the Local End IP address. This field is N/A for One-to-One and Server mapping types.
Global Start IP	This refers to the Inside Global IP Address (IGA). 0.0.0.0 is for a dynamic IP address from your ISP with Many-to-One and Server mapping types.
Global End IP	This is the ending Inside Global Address (IGA), which is the starting global IP address. This field is N/A for One-to-One , Many-to-One and Server mapping types.
Type	<ol style="list-style-type: none"> 1. One-to-One mode maps one local IP address to one global IP address. Note that port numbers do not change for the One-to-one NAT mapping type. 2. Many-to-One mode maps multiple local IP addresses to one global IP address. This is equivalent to SUA (i.e., PAT, port address translation), ZyXEL's Single User Account feature that previous ZyXEL routers supported only. 3. Many-to-Many Overload mode maps multiple local IP addresses to shared global IP addresses. 4. Many One-to-One mode maps each local IP address to unique global IP addresses. 5. Server allows you to specify inside servers of different services behind the NAT to be accessible to the outside world.
Edit	Select the radio button next to a rule and click Edit to go to the Address Mapping Edit screen for that rule.
Delete	Select the radio button next to a rule and click Delete to delete the address mapping rule.
Insert	Click Insert to insert a new mapping rule before an existing one.

9.5.1 Address Mapping Edit

To edit an Address Mapping rule, click the **Edit** button to display the screen shown next.

Figure 9-6 Address Mapping Edit

The following table describes the labels in this screen.

Table 9-7 Address Mapping Edit

LABEL	DESCRIPTION
Type	<p>Choose the port mapping type from one of the following.</p> <ol style="list-style-type: none"> 1. One-to-One: One-to-one mode maps one local IP address to one global IP address. Note that port numbers do not change for One-to-one NAT mapping type. 2. Many-to-One: Many-to-One mode maps multiple local IP addresses to one global IP address. This is equivalent to SUA (i.e., PAT, port address translation), ZyXEL's Single User Account feature. 3. Many-to-Many Ov (Overload): Many-to-Many Overload mode maps multiple local IP addresses to shared global IP addresses. 4. Many One-to-One: Many One-to-one mode maps each local IP address to unique global IP addresses. 5. Server: This type allows you to specify inside servers of different services behind the NAT to be accessible to the outside world.
Local Start IP	This is the starting Inside Local IP Address (ILA). Local IP addresses are N/A for Server port mapping.
Local End IP	<p>This is the end Inside Local IP Address (ILA). If your rule is for all local IP addresses, then enter 0.0.0.0 as the Local Start IP address and 255.255.255.255 as the Local End IP address.</p> <p>This field is N/A for One-to-One and Server mapping types.</p>
Global Start IP	This is the starting Inside Global IP Address (IGA). Enter 0.0.0.0 here if you have a dynamic IP address from your ISP.

Table 9-7 Address Mapping Edit

LABEL	DESCRIPTION
Global End IP	This is the ending Inside Global IP Address (IGA). This field is N/A for One-to-One , Many-to-One and Server mapping types.
Apply	Click Apply to save your changes back to the ZyWALL.
Reset	Click Reset to begin configuring this screen afresh.

9.6 Trigger Port Forwarding

Some services use a dedicated range of ports on the client side and a dedicated range of ports on the server side. With regular port forwarding you set a forwarding port in NAT to forward a service (coming in from the server on the WAN) to the IP address of a computer on the client side (LAN). The problem is that port forwarding only forwards a service to a single LAN IP address. In order to use the same service on a different LAN computer, you have to manually replace the LAN computer's IP address in the forwarding port with another LAN computer's IP address,

Trigger port forwarding solves this problem by allowing computers on the LAN to dynamically take turns using the service. The ZyWALL records the IP address of a LAN computer that sends traffic to the WAN to request a service with a specific port number and protocol (a "trigger" port). When the ZyWALL's WAN port receives a response with a specific port number and protocol ("incoming" port), the ZyWALL forwards the traffic to the LAN IP address of the computer that sent the request. After that computer's connection for that service closes, another computer on the LAN can use the service in the same manner. This way you do not need to configure a new IP address each time you want a different LAN computer to use the application.

9.6.1 Trigger Port Forwarding Example

The following is an example of trigger port forwarding.

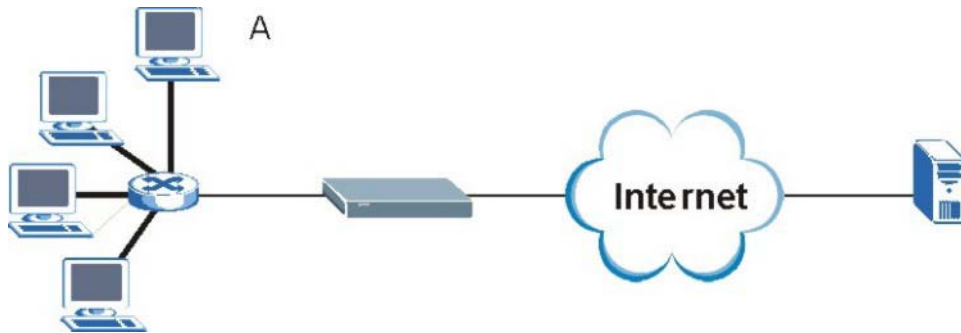

Figure 9-7 Trigger Port Forwarding Process: Example

1. Jane (A) requests a file from the Real Audio server (port 7070).
2. Port 7070 is a “trigger” port and causes the ZyWALL to record Jane’s computer IP address. The ZyWALL associates Jane’s computer IP address with the "incoming" port range of 6970-7170.
3. The Real Audio server responds using a port number ranging between 6970-7170.
4. The ZyWALL forwards the traffic to Jane’s computer IP address.
5. Only Jane can connect to the Real Audio server until the connection is closed or times out. The ZyWALL times out in three minutes with UDP (User Datagram Protocol) or two hours with TCP/IP (Transfer Control Protocol/Internet Protocol).

9.6.2 Two Points To Remember About Trigger Ports

1. Trigger events only happen on data that is going coming from inside the ZyWALL and going to the outside.
2. If an application needs a continuous data stream, that port (range) will be tied up so that another computer on the LAN can’t trigger it.

9.7 Configuring Trigger Port Forwarding

To change your ZyWALL’s trigger port settings, click **SUA/NAT** and the **Trigger Port** tab. The screen appears as shown.

Only one LAN computer can use a trigger port (range) at a time.

SUA/NAT

SUA Server Address Mapping **Trigger Port**

#	Name	Incoming		Trigger	
		Start Port	End Port	Start Port	End Port
1		0	0	0	0
2		0	0	0	0
3		0	0	0	0
4		0	0	0	0
5		0	0	0	0
6		0	0	0	0
7		0	0	0	0
8		0	0	0	0
9		0	0	0	0
10		0	0	0	0
11		0	0	0	0
12		0	0	0	0

Apply Reset

Figure 9-8 Trigger Port

The following table describes the labels in this screen.

Table 9-8 Trigger Port

LABEL	DESCRIPTION
No.	This is the rule index number (read-only).
Name	Type a unique name (up to 15 characters) for identification purposes. All characters are permitted - including spaces.
Incoming	Incoming is a port (or a range of ports) that a server on the WAN uses when it sends out a particular service. The ZyWALL forwards the traffic with this port (or range of ports) to the client computer on the LAN that requested the service.
Start Port	Type a port number or the starting port number in a range of port numbers.
End Port	Type a port number or the ending port number in a range of port numbers.
Trigger	The trigger port is a port (or a range of ports) that causes (or triggers) the ZyWALL to record the IP address of the LAN computer that sent the traffic to a server on the WAN.

Table 9-8 Trigger Port

LABEL	DESCRIPTION
Start Port	Type a port number or the starting port number in a range of port numbers.
End Port	Type a port number or the ending port number in a range of port numbers.
Apply	Click Apply to save your changes back to the ZyWALL.
Reset	Click Reset to begin configuring this screen afresh.

Chapter 10

Static Route Screens

This chapter shows you how to configure static routes for your ZyWALL.

10.1 Static Route Overview

Each remote node specifies only the network to which the gateway is directly connected, and the ZyWALL has no knowledge of the networks beyond. For instance, the ZyWALL knows about network N2 in the following figure through remote node router R1. However, the ZyWALL is unable to route a packet to network N3 because it doesn't know that there is a route through the same remote node router R1 (via gateway router R2). The static routes are for you to tell the ZyWALL about the networks beyond the remote nodes.

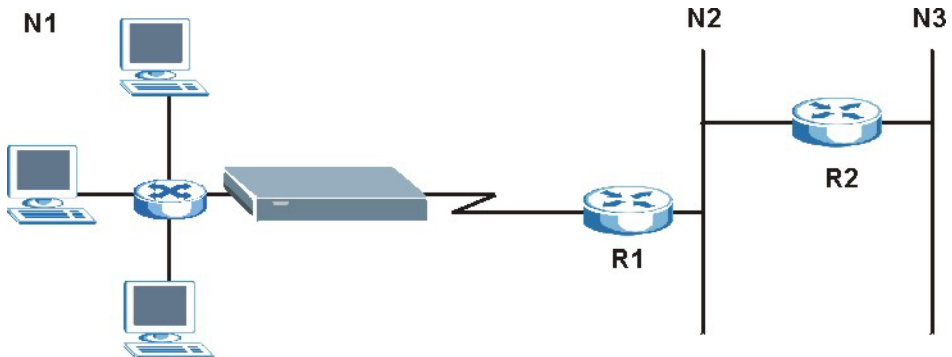

Figure 10-1 Example of Static Routing Topology

10.2 Configuring IP Static Route

Click **STATIC ROUTE** to open the **IP Static Route** screen.



Figure 10-2 IP Static Route

The following table describes the labels in this screen.

Table 10-1 IP Static Route

LABEL	DESCRIPTION
#	Number of an individual static route.
Name	Name that describes or identifies this route.
Active	This field shows whether this static route is active (Yes) or not (No).
Destination	This parameter specifies the IP network address of the final destination. Routing is always based on network number.
Gateway	This is the IP address of the gateway. The gateway is an immediate neighbor of your ZyWALL that will forward the packet to the destination. On the LAN, the gateway must be a router on the same segment as your ZyWALL; over the WAN, the gateway must be the IP address of one of the remote nodes.
Edit	Click a static route index number and then click Edit to set up a static route on the ZyWALL.

10.2.1 Configuring a Static Route Entry

Select a static route index number and click **Edit**. The screen shown next appears. Fill in the required information for each static route.

Figure 10-3 Edit IP Static Route

The following table describes the labels in this screen.

Table 10-2 Edit IP Static Route

LABEL	DESCRIPTION
Route Name	Enter the name of the IP static route. Leave this field blank to delete this static route.
Active	This field allows you to activate/deactivate this static route.
Destination IP Address	This parameter specifies the IP network address of the final destination. Routing is always based on network number. If you need to specify a route to a single host, use a subnet mask of 255.255.255.255 in the subnet mask field to force the network number to be identical to the host ID.
IP Subnet Mask	Enter the IP subnet mask here.
Gateway IP Address	Enter the IP address of the gateway. The gateway is an immediate neighbor of your ZyWALL that will forward the packet to the destination. On the LAN, the gateway must be a router on the same segment as your ZyWALL; over the WAN, the gateway must be the IP address of one of the Remote Nodes.

Table 10-2 Edit IP Static Route

LABEL	DESCRIPTION
Metric	Metric represents the “cost” of transmission for routing purposes. IP routing uses hop count as the measurement of cost, with a minimum of 1 for directly connected networks. Enter a number that approximates the cost for this link. The number need not be precise, but it must be between 1 and 15. In practice, 2 or 3 is usually a good number.
Private	This parameter determines if the ZyWALL will include this route to a remote node in its RIP broadcasts. Select this check box to keep this route private and not included in RIP broadcasts. Clear this checkbox to propagate this route to other hosts through RIP broadcasts.
Apply	Click Apply to save your changes back to the ZyWALL.
Reset	Click Reset to begin configuring this screen afresh.

Part V:

Firewall and Content Filtering

This part introduces firewalls in general and the ZyWALL firewall. It also explains how to configure the ZyWALL firewall and content filtering.

Chapter 11

Firewalls

This chapter gives some background information on firewalls and introduces the ZyWALL firewall.

11.1 Firewall Overview

Originally, the term *firewall* referred to a construction technique designed to prevent the spread of fire from one room to another. The networking term “firewall” is a system or group of systems that enforces an access-control policy between two networks. It may also be defined as a mechanism used to protect a trusted network from an untrusted network. Of course, firewalls cannot solve every security problem. A firewall is *one* of the mechanisms used to establish a network security perimeter in support of a network security policy. It should never be the *only* mechanism or method employed. For a firewall to guard effectively, you must design and deploy it appropriately. This requires integrating the firewall into a broad information-security policy. In addition, specific policies must be implemented within the firewall itself.

11.2 Types of Firewalls

There are three main types of firewalls:

1. Packet Filtering Firewalls
2. Application-level Firewalls
3. Stateful Inspection Firewalls

11.2.1 Packet Filtering Firewalls

Packet filtering firewalls restrict access based on the source/destination computer network address of a packet and the type of application.

11.2.2 Application-level Firewalls

Application-level firewalls restrict access by serving as proxies for external servers. Since they use programs written for specific Internet services, such as HTTP, FTP and telnet, they can evaluate network packets for valid application-specific data. Application-level gateways have a number of general advantages over the default mode of permitting application traffic directly to internal hosts:

- i. Information hiding prevents the names of internal systems from being made known via DNS to outside systems, since the application gateway is the only host whose name must be made known to outside systems.
- ii. Robust authentication and logging pre-authenticates application traffic before it reaches internal hosts and causes it to be logged more effectively than if it were logged with standard host logging. Filtering rules at the packet filtering router can be less complex than they would be if the router needed to filter application traffic and direct it to a number of specific systems. The router need only allow application traffic destined for the application gateway and reject the rest.

11.2.3 Stateful Inspection Firewalls

Stateful inspection firewalls restrict access by screening data packets against defined access rules. They make access control decisions based on IP address and protocol. They also "inspect" the session data to assure the integrity of the connection and to adapt to dynamic protocols. These firewalls generally provide the best speed and transparency; however, they may lack the granular application level access control or caching that some proxies support. See *section 11.5* for more information on Stateful Inspection.

Firewalls, of one type or another, have become an integral part of standard security solutions for enterprises.

11.3 Introduction to ZyXEL's Firewall

The ZyWALL firewall is a stateful inspection firewall and is designed to protect against Denial of Service attacks when activated (in SMT menu 21.2 or in the web configurator). The ZyWALL's purpose is to allow a private Local Area Network (LAN) to be securely connected to the Internet. The ZyWALL can be used to prevent theft, destruction and modification of data, as well as log events, which may be important to the security of your network. The ZyWALL also has packet-filtering capabilities.

The ZyWALL is installed between the LAN and a broadband modem connecting to the Internet. This allows it to act as a secure gateway for all data passing between the Internet and the LAN.

The ZyWALL has one Ethernet WAN port and one Ethernet LAN port, which are used to physically separate the network into two areas.

- ❑ The WAN (Wide Area Network) port attaches to the broadband modem (cable or ADSL) connecting to the Internet.
- ❑ The LAN (Local Area Network) port attaches to a network of computers, which needs security from the outside world. These computers will have access to Internet services such as e-mail, FTP, and the World Wide Web. However, "inbound access" will not be allowed unless the remote host is authorized to use a specific service.

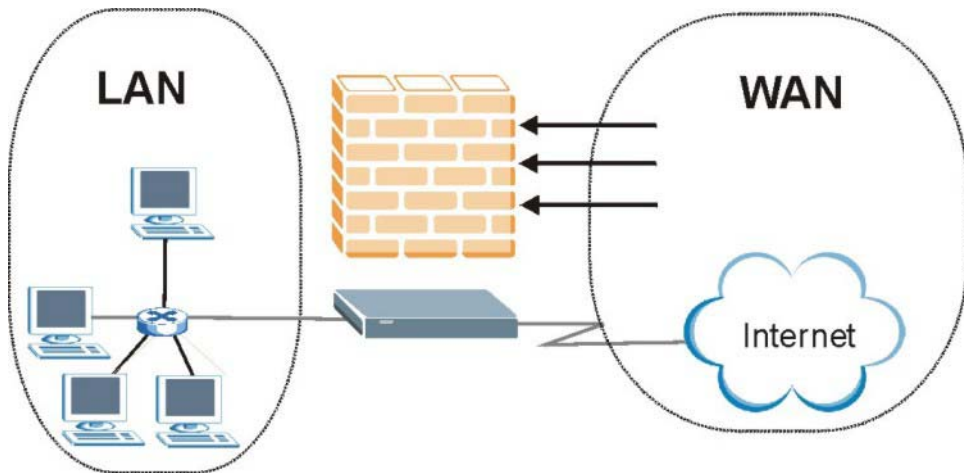

Figure 11-1 ZyWALL Firewall Application

11.4 Denial of Service

Denials of Service (DoS) attacks are aimed at devices and networks with a connection to the Internet. Their goal is not to steal information, but to disable a device or network so users no longer have access to network resources. The ZyWALL is pre-configured to automatically detect and thwart all known DoS attacks.

11.4.1 Basics

Computers share information over the Internet using a common language called TCP/IP. TCP/IP, in turn, is a set of application protocols that perform specific functions. An “extension number”, called the "TCP port" or "UDP port" identifies these protocols, such as HTTP (Web), FTP (File Transfer Protocol), POP3 (E-mail), etc. For example, Web traffic by default uses TCP port 80.

When computers communicate on the Internet, they are using the client/server model, where the server "listens" on a specific TCP/UDP port for information requests from remote client computers on the network. For example, a Web server typically listens on port 80. Please note that while a computer may be intended for use over a single port, such as Web on port 80, other ports are also active. If the person configuring or managing the computer is not careful, a hacker could attack it over an unprotected port.

Some of the most common IP ports are:

Table 11-1 Common IP Ports

21	FTP	53	DNS
23	Telnet	80	HTTP
25	SMTP	110	POP3

11.4.2 Types of DoS Attacks

There are four types of DoS attacks:

1. Those that exploit bugs in a TCP/IP implementation.
 2. Those that exploit weaknesses in the TCP/IP specification.
 3. Brute-force attacks that flood a network with useless data.
 4. IP Spoofing.
1. **"Ping of Death"** and **"Teardrop"** attacks exploit bugs in the TCP/IP implementations of various computer and host systems.
 - 1-a Ping of Death uses a "ping" utility to create an IP packet that exceeds the maximum 65,536 bytes of data allowed by the IP specification. The oversize packet is then sent to an unsuspecting system. Systems may crash, hang or reboot.
 - 1-b Teardrop attack exploits weaknesses in the reassembly of IP packet fragments. As data is transmitted through a network, IP packets are often broken up into smaller chunks. Each fragment looks like the original IP packet except that it contains an offset field that says, for instance, "This fragment is carrying bytes 200 through 400 of the original (non fragmented) IP packet." The Teardrop program creates a series of IP fragments with overlapping offset fields. When these fragments are reassembled at the destination, some systems will crash, hang, or reboot.
 2. Weaknesses in the TCP/IP specification leave it open to **"SYN Flood"** and **"LAND"** attacks. These attacks are executed during the handshake that initiates a communication session between two applications.

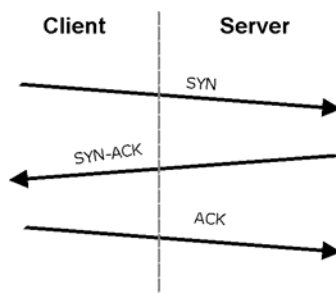

Figure 11-2 Three-Way Handshake

Under normal circumstances, the application that initiates a session sends a SYN (synchronize) packet to the receiving server. The receiver sends back an ACK (acknowledgment) packet and its own SYN, and then the initiator responds with an ACK (acknowledgment). After this handshake, a connection is established.

2-a **SYN Attack** floods a targeted system with a series of SYN packets. Each packet causes the targeted system to issue a SYN-ACK response. While the targeted system waits for the ACK that follows the SYN-ACK, it queues up all outstanding SYN-ACK responses on what is known as a backlog queue. SYN-ACKs are moved off the queue only when an ACK comes back or when an internal timer (which is set at relatively long intervals) terminates the three-way handshake. Once the queue is full, the system will ignore all incoming SYN requests, making the system unavailable for legitimate users.

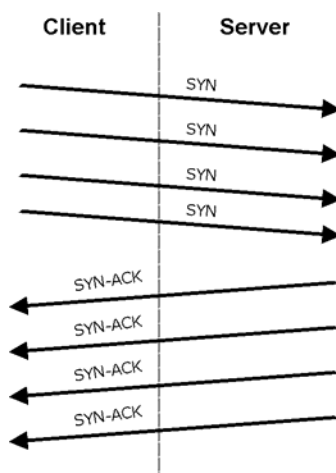

Figure 11-3 SYN Flood

2-b In a **LAND Attack**, hackers flood SYN packets into the network with a spoofed source IP address of the targeted system. This makes it appear as if the host computer sent the packets to itself, making the system unavailable while the target system tries to respond to itself.

3. A **brute-force** attack, such as a "Smurf" attack, targets a feature in the IP specification known as directed or subnet broadcasting, to quickly flood the target network with useless data. A Smurf hacker floods a router with Internet Control Message Protocol (ICMP) echo request packets (pings). Since the destination IP address of each packet is the broadcast address of the network, the router will broadcast the ICMP echo request packet to all hosts on the network. If there are numerous hosts, this will create a large amount of ICMP echo request and response traffic. If a hacker chooses to spoof the source IP address of the ICMP echo request packet, the resulting ICMP traffic will not only clog up the "intermediary" network, but will also congest the network of the spoofed source IP address, known as the "victim" network. This flood of broadcast traffic consumes all available bandwidth, making communications impossible.

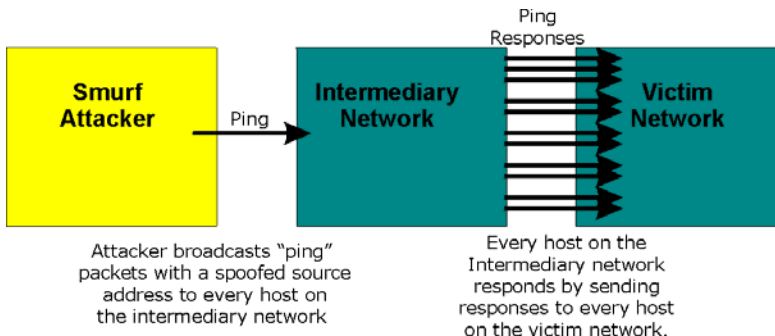

Figure 11-4 Smurf Attack

❑ ICMP Vulnerability

ICMP is an error-reporting protocol that works in concert with IP. The following ICMP types trigger an alert:

Table 11-2 ICMP Commands That Trigger Alerts

5	REDIRECT
13	TIMESTAMP_REQUEST
14	TIMESTAMP_REPLY
17	ADDRESS_MASK_REQUEST
18	ADDRESS_MASK_REPLY

❑ Illegal Commands (NetBIOS and SMTP)

The only legal NetBIOS commands are the following - all others are illegal.

Table 11-3 Legal NetBIOS Commands

MESSAGE:
REQUEST:
POSITIVE:
NEGATIVE:
RETARGET:
KEEPALIVE:

All SMTP commands are illegal except for those displayed in the following tables.

Table 11-4 Legal SMTP Commands

AUTH	DATA	EHLO	ETRN	EXPN	HELO	HELP	MAIL	NOOP
QUIT	RCPT	RSET	SAML	SEND	SOML	TURN	VERFY	

Traceroute

Traceroute is a utility used to determine the path a packet takes between two endpoints. Sometimes when a packet filter firewall is configured incorrectly an attacker can traceroute the firewall gaining knowledge of the network topology inside the firewall.

- Often, many DoS attacks also employ a technique known as "**IP Spoofing**" as part of their attack. IP Spoofing may be used to break into systems, to hide the hacker's identity, or to magnify the effect of the DoS attack. IP Spoofing is a technique used to gain unauthorized access to computers by tricking a router or firewall into thinking that the communications are coming from within the trusted network. To engage in IP spoofing, a hacker must modify the packet headers so that it appears that the packets originate from a trusted host and should be allowed through the router or firewall. The ZyWALL blocks all IP Spoofing attempts.

11.5 Stateful Inspection

With stateful inspection, fields of the packets are compared to packets that are already known to be trusted. For example, if you access some outside service, the proxy server remembers things about your original request, like the port number and source and destination addresses. This "remembering" is called *saving the state*. When the outside system responds to your request, the firewall compares the received packets with the saved state to determine if they are allowed in. The ZyWALL uses stateful packet inspection to protect the private LAN from hackers and vandals on the Internet. By default, the ZyWALL's stateful inspection allows all communications to the Internet that originate from the LAN, and blocks all traffic to the LAN that originates from the Internet. In summary, stateful inspection:

- ❑ Allows all sessions originating from the LAN (local network) to the WAN (Internet).
- ❑ Denies all sessions originating from the WAN to the LAN.

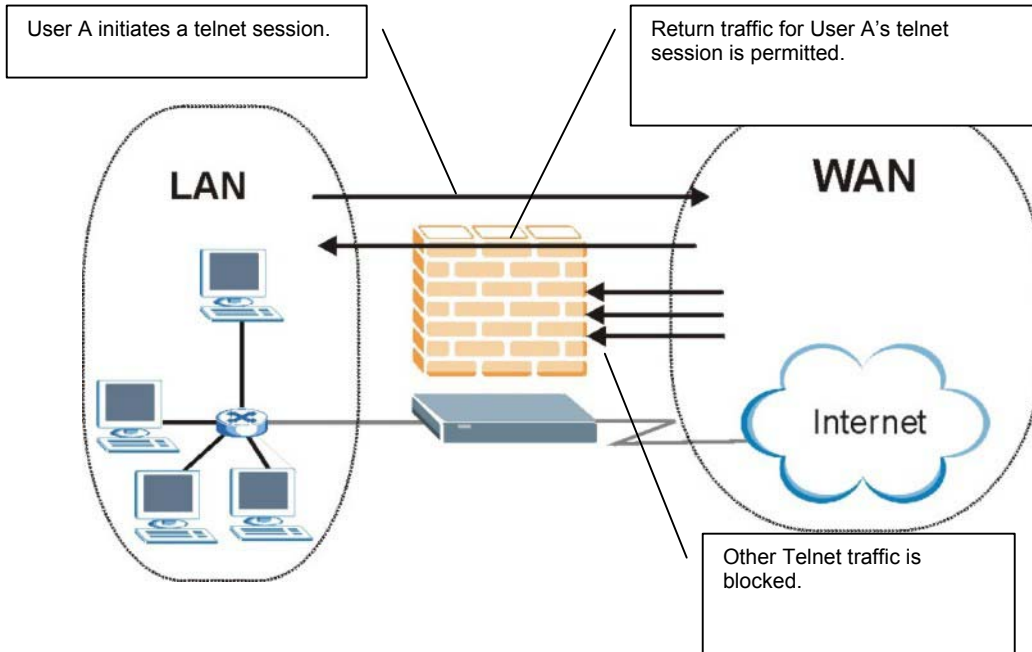

Figure 11-5 Stateful Inspection

The previous figure shows the ZyWALL's default firewall rules in action as well as demonstrates how stateful inspection works. User A can initiate a Telnet session from within the LAN and responses to this request are allowed. However other Telnet traffic initiated from the WAN is blocked.

11.5.1 Stateful Inspection Process

In this example, the following sequence of events occurs when a TCP packet leaves the LAN network through the firewall's WAN interface. The TCP packet is the first in a session, and the packet's application layer protocol is configured for a firewall rule inspection:

1. The packet travels from the firewall's LAN to the WAN.
2. The packet is evaluated against the interface's existing outbound access list, and the packet is permitted (a denied packet would simply be dropped at this point).

3. The packet is inspected by the firewall to determine and record information about the state of the packet's connection. This information is recorded in a new state table entry created for the new connection. If there is not a firewall rule for this packet and it is not an attack, then **Firewall Summary** screen's **Action for packets that don't match firewall rules** field determines the action for this packet.
4. Based on the obtained state information, a firewall rule creates a temporary access list entry that is inserted at the beginning of the WAN interface's inbound extended access list. This temporary access list entry is designed to permit inbound packets of the same connection as the outbound packet just inspected.
5. The outbound packet is forwarded out through the interface.
6. Later, an inbound packet reaches the interface. This packet is part of the connection previously established with the outbound packet. The inbound packet is evaluated against the inbound access list, and is permitted because of the temporary access list entry previously created.
7. The packet is inspected by a firewall rule, and the connection's state table entry is updated as necessary. Based on the updated state information, the inbound extended access list temporary entries might be modified, in order to permit only packets that are valid for the current state of the connection.
8. Any additional inbound or outbound packets that belong to the connection are inspected to update the state table entry and to modify the temporary inbound access list entries as required, and are forwarded through the interface.
9. When the connection terminates or times out, the connection's state table entry is deleted and the connection's temporary inbound access list entries are deleted.

11.5.2 Stateful Inspection and the ZyWALL

Additional rules may be defined to extend or override the default rules. For example, a rule may be created which will:

- i. Block all traffic of a certain type, such as IRC (Internet Relay Chat), from the LAN to the Internet.
- ii. Allow certain types of traffic from the Internet to specific hosts on the LAN.
- iii. Allow access to a Web server to everyone but competitors.
- iv. Restrict use of certain protocols, such as Telnet, to authorized users on the LAN.

These custom rules work by evaluating the network traffic's Source IP address, Destination IP address, IP protocol type, and comparing these to rules set by the administrator.

The ability to define firewall rules is a very powerful tool. Using custom rules, it is possible to disable all firewall protection or block all access to the Internet. Use extreme caution when creating or deleting firewall rules. Test changes after creating them to make sure they work correctly.

Below is a brief technical description of how these connections are tracked. Connections may either be defined by the upper protocols (for instance, TCP), or by the ZyWALL itself (as with the "virtual connections" created for UDP and ICMP).

11.5.3 TCP Security

The ZyWALL uses state information embedded in TCP packets. The first packet of any new connection has its SYN flag set and its ACK flag cleared; these are "initiation" packets. All packets that do not have this flag structure are called "subsequent" packets, since they represent data that occurs later in the TCP stream.

If an initiation packet originates on the WAN, this means that someone is trying to make a connection from the Internet into the LAN. Except in a few special cases (see "Upper Layer Protocols" shown next), these packets are dropped and logged.

If an initiation packet originates on the LAN, this means that someone is trying to make a connection from the LAN to the Internet. Assuming that this is an acceptable part of the security policy (as is the case with the default policy), the connection will be allowed. A cache entry is added which includes connection information such as IP addresses, TCP ports, sequence numbers, etc.

When the ZyWALL receives any subsequent packet (from the Internet or from the LAN), its connection information is extracted and checked against the cache. A packet is only allowed to pass through if it corresponds to a valid connection (that is, if it is a response to a connection which originated on the LAN).

11.5.4 UDP/ICMP Security

UDP and ICMP do not themselves contain any connection information (such as sequence numbers). However, at the very minimum, they contain an IP address pair (source and destination). UDP also contains port pairs, and ICMP has type and code information. All of this data can be analyzed in order to build "virtual connections" in the cache.

For instance, any UDP packet that originates on the LAN will create a cache entry. Its IP address and port pairs will be stored. For a short period of time, UDP packets from the WAN that have matching IP and UDP information will be allowed back in through the firewall.

A similar situation exists for ICMP, except that the ZyWALL is even more restrictive. Specifically, only outgoing echoes will allow incoming echo replies, outgoing address mask requests will allow incoming address mask replies, and outgoing timestamp requests will allow incoming timestamp replies. No other ICMP packets are allowed in through the firewall, simply because they are too dangerous and contain too

little tracking information. For instance, ICMP redirect packets are never allowed in, since they could be used to reroute traffic through attacking machines.

11.5.5 Upper Layer Protocols

Some higher layer protocols (such as FTP and RealAudio) utilize multiple network connections simultaneously. In general terms, they usually have a "control connection" which is used for sending commands between endpoints, and then "data connections" which are used for transmitting bulk information.

Consider the FTP protocol. A user on the LAN opens a control connection to a server on the Internet and requests a file. At this point, the remote server will open a data connection from the Internet. For FTP to work properly, this connection must be allowed to pass through even though a connection from the Internet would normally be rejected.

In order to achieve this, the ZyWALL inspects the application-level FTP data. Specifically, it searches for outgoing "PORT" commands, and when it sees these; it adds a cache entry for the anticipated data connection. This can be done safely, since the PORT command contains address and port information, which can be used to uniquely identify the connection.

Any protocol that operates in this way must be supported on a case-by-case basis. You can use the web configurator's Custom Ports feature to do this.

11.6 Guidelines For Enhancing Security With Your Firewall

1. Change the default password via SMT or web configurator.
2. Think about access control *before* you connect a console port to the network in any way, including attaching a modem to the port. Be aware that a break on the console port might give unauthorized individuals total control of the firewall, even with access control configured.
3. Limit who can telnet into your router.
4. Don't enable any local service (such as SNMP or NTP) that you don't use. Any enabled service could present a potential security risk. A determined hacker might be able to find creative ways to misuse the enabled services to access the firewall or the network.
5. For local services that are enabled, protect against misuse. Protect by configuring the services to communicate only with specific peers, and protect by configuring rules to block packets for the services at specific interfaces.
6. Protect against IP spoofing by making sure the firewall is active.
7. Keep the firewall in a secured (locked) room.

11.7 Packet Filtering Vs Firewall

Below are some comparisons between the ZyWALL's filtering and firewall functions.

11.7.1 Packet Filtering:

- ❑ The router filters packets as they pass through the router's interface according to the filter rules you designed.
- ❑ Packet filtering is a powerful tool, yet can be complex to configure and maintain, especially if you need a chain of rules to filter a service.
- ❑ Packet filtering only checks the header portion of an IP packet.

When To Use Filtering

1. To block/allow LAN packets by their MAC addresses.
2. To block/allow special IP packets which are neither TCP nor UDP, nor ICMP packets.
3. To block/allow both inbound (WAN to LAN) and outbound (LAN to WAN) traffic between the specific inside host/network "A" and outside host/network "B". If the filter blocks the traffic from A to B, it also blocks the traffic from B to A. Filters cannot distinguish traffic originating from an inside host or an outside host by IP address.
4. To block/allow IP trace route.

11.7.2 Firewall

- ❑ The firewall inspects packet contents as well as their source and destination addresses. Firewalls of this type employ an inspection module, applicable to all protocols, that understands data in the packet is intended for other layers, from the network layer (IP headers) up to the application layer.
- ❑ The firewall performs stateful inspection. It takes into account the state of connections it handles so that, for example, a legitimate incoming packet can be matched with the outbound request for that packet and allowed in. Conversely, an incoming packet masquerading as a response to a nonexistent outbound request can be blocked.
- ❑ The firewall uses session filtering, i.e., smart rules, that enhance the filtering process and control the network session rather than control individual packets in a session.
- ❑ The firewall provides e-mail service to notify you of routine reports and when alerts occur.

When To Use The Firewall

1. To prevent DoS attacks and prevent hackers cracking your network.

2. A range of source and destination IP addresses as well as port numbers can be specified within one firewall rule making the firewall a better choice when complex rules are required.
3. To selectively block/allow inbound or outbound traffic between inside host/networks and outside host/networks. Remember that filters cannot distinguish traffic originating from an inside host or an outside host by IP address.
4. The firewall performs better than filtering if you need to check many rules.
5. Use the firewall if you need routine e-mail reports about your system or need to be alerted when attacks occur.
6. The firewall can block specific URL traffic that might occur in the future. The URL can be saved in an Access Control List (ACL) database.

Chapter 12

Firewall Screens

This chapter shows you how to configure your ZyWALL firewall.

12.1 Access Methods

The web configurator is, by far, the most comprehensive firewall configuration tool your ZyWALL has to offer. For this reason, it is recommended that you configure your firewall using the web configurator. SMT screens allow you to activate the firewall. CLI commands provide limited configuration options and are only recommended for advanced users, please refer to the *Appendices* for firewall CLI commands.

12.2 Firewall Policies Overview

Firewall rules are grouped based on the direction of travel of packets to which they apply:

- LAN to LAN/ZyWALL
- LAN to WAN
- LAN to DMZ
- WAN to LAN
- WAN to WAN/ZyWALL
- WAN to DMZ
- DMZ to LAN
- DMZ to WAN
- DMZ to DMZ/ZyWALL

DMZ is not available on all models.

By default, the ZyWALL's stateful packet inspection allows packets traveling in the following directions:

- LAN to LAN/ZyWALL
This allows computers on the LAN to manage the ZyWALL and communicate between networks or subnets connected to the LAN interface.
- LAN to WAN
- LAN to DMZ
- WAN to DMZ
- DMZ to WAN

By default, the ZyWALL's stateful packet inspection blocks packets traveling in the following directions:

- WAN to LAN
- WAN to WAN/ZyWALL

This prevents computers on the WAN from using the ZyWALL as a gateway to communicate with other computers on the WAN and/or managing the ZyWALL.

- DMZ to LAN
- DMZ to DMZ/ZyWALL

This prevents computers on the DMZ from communicating between networks or subnets connected to the DMZ interface and/or managing the ZyWALL.

You may define additional rules and sets or modify existing ones but please exercise extreme caution in doing so.

If you configure firewall rules without a good understanding of how they work, you might inadvertently introduce security risks to the firewall and to the protected network. Make sure you test your rules after you configure them.

For example, you may create rules to:

- ◆ Block certain types of traffic, such as IRC (Internet Relay Chat), from the LAN to the Internet.
- ◆ Allow certain types of traffic, such as Lotus Notes database synchronization, from specific hosts on the Internet to specific hosts on the LAN.
- ◆ Allow everyone except your competitors to access a Web server.
- ◆ Restrict use of certain protocols, such as Telnet, to authorized users on the LAN.

These custom rules work by comparing the Source IP address, Destination IP address and IP protocol type of network traffic to rules set by the administrator. Your customized rules take precedence and override the ZyWALL's default rules.

12.3 Rule Logic Overview

Study these points carefully before configuring rules.

12.3.1 Rule Checklist

1. State the intent of the rule. For example, "This restricts all IRC access from the LAN to the Internet." Or, "This allows a remote Lotus Notes server to synchronize over the Internet to an inside Notes server."
2. Is the intent of the rule to forward or block traffic?
3. What direction of traffic does the rule apply to (refer to 12.2)?
4. What IP services will be affected?

5. What computers on the LAN or DMZ are to be affected (if any)?
6. What computers on the Internet will be affected? The more specific, the better. For example, if traffic is being allowed from the Internet to the LAN, it is better to allow only certain machines on the Internet to access the LAN.

12.3.2 Security Ramifications

Once the logic of the rule has been defined, it is critical to consider the security ramifications created by the rule:

1. Does this rule stop LAN users from accessing critical resources on the Internet? For example, if IRC is blocked, are there users that require this service?
2. Is it possible to modify the rule to be more specific? For example, if IRC is blocked for all users, will a rule that blocks just certain users be more effective?
3. Does a rule that allows Internet users access to resources on the LAN create a security vulnerability? For example, if FTP ports (TCP 20, 21) are allowed from the Internet to the LAN, Internet users may be able to connect to computers with running FTP servers.
4. Does this rule conflict with any existing rules?

Once these questions have been answered, adding rules is simply a matter of plugging the information into the correct fields in the web configurator screens.

12.3.3 Key Fields For Configuring Rules

Action

Should the action be to **Block** or **Forward**?

“Block” means the firewall silently discards the packet.

Service

Select the service from the **Service** scrolling list box. If the service is not listed, it is necessary to first define it. See *section 12.10* for more information on predefined services.

Source Address

What is the connection’s source address; is it on the LAN, DMZ or WAN? Is it a single IP, a range of IPs or a subnet?

Destination Address

What is the connection's destination address; is it on the LAN, DMZ or WAN? Is it a single IP, a range of IPs or a subnet?

12.4 Connection Direction Examples

This section describes examples for firewall rules for connections going from LAN to WAN and from WAN to LAN. Rules for the DMZ work in a similar fashion.

LAN to LAN/ZyWALL, WAN to WAN/ZyWALL and DMZ to DMZ/ZyWALL rules apply to packets coming in on the associated interface (LAN, WAN, or DMZ respectively). LAN to LAN/ZyWALL means policies for LAN-to-ZyWALL (the policies for managing the ZyWALL through the LAN interface) and policies for LAN-to-LAN (the policies that control routing between two subnets on the LAN). Similarly, WAN to WAN/ZyWALL and DMZ to DMZ/ZyWALL policies apply in the same way to the WAN and DMZ ports.

12.4.1 LAN to WAN Rules

The default rule for LAN to WAN traffic is that all users on the LAN are allowed non-restricted access to the WAN. When you configure a LAN to WAN rule, you in essence want to limit some or all users from accessing certain services on the WAN. See the following figure.

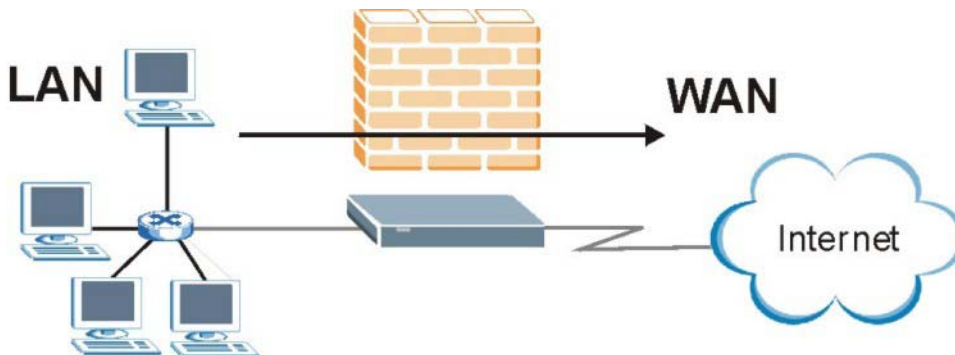

Figure 12-1 LAN to WAN Traffic

12.4.2 WAN to LAN Rules

The default rule for WAN to LAN traffic blocks all incoming connections (WAN to LAN). If you wish to allow certain WAN users to have access to your LAN, you will need to create custom rules to allow it.

See the following figure.

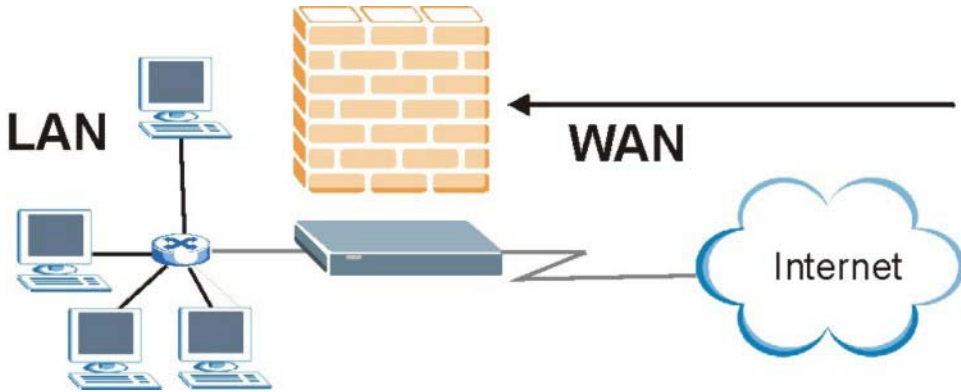

Figure 12-2 WAN to LAN Traffic

12.5 Bandwidth Management - Lite

Bandwidth management lite allows you to use firewall rules to perform basic bandwidth management.

You can apply bandwidth management to firewall rules based on applications, IP addresses (including individual IP addresses, ranges or subnets) or a combination of the two.

You can use bandwidth management to guarantee bandwidth for delay-sensitive applications such as Voice-over-IP (VoIP). You can also limit the bandwidth used by bandwidth-hungry applications (or individuals) by allocating the maximum bandwidth for traffic that matches a firewall rule.

Enable bandwidth management in the **BM Global Setting** screen and apply bandwidth management to individual firewall rules in the **Firewall Edit Rule** screen (go to the **Summary** screen and click **Insert** to create a new rule or select an existing rule's radio button and click **Edit** to edit the rule).

12.6 Bandwidth Management Usage Examples

These examples show bandwidth management allotments on a WAN interface that is configured for 10Mbps.

12.6.1 Application-based Bandwidth Management Example

The bandwidth classes in the following example are based solely on application. Each bandwidth class (VoIP, Web, FTP, E-mail and Video) is allotted 128 Kbps.

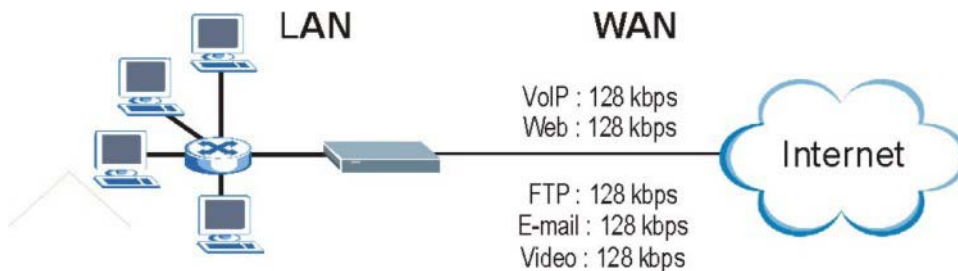

Figure 12-3 Application-based Bandwidth Management Example

12.6.2 Subnet-based Bandwidth Management Example

The following example uses bandwidth classes based solely on LAN subnets. Each bandwidth class (Subnet A and Subnet B) is allotted 320 Kbps.

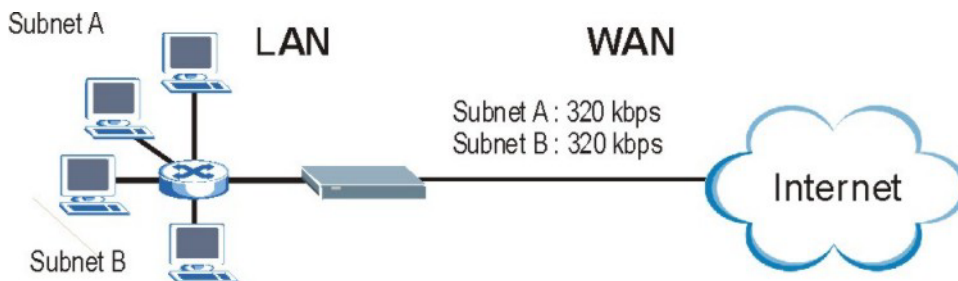

Figure 12-4 Subnet-based Bandwidth Management Example

12.6.3 Application and Subnet-based Bandwidth Management Example

The following example uses bandwidth classes based on LAN subnets and applications (specific applications in each subnet are allotted bandwidth).

Table 12-1 Application and Subnet-based Bandwidth Management Example

TRAFFIC TYPE	FROM SUBNET A	FROM SUBNET B
VoIP	64 Kbps	64 Kbps
Web	64 Kbps	64 Kbps
FTP	64 Kbps	64 Kbps

Table 12-1 Application and Subnet-based Bandwidth Management Example

TRAFFIC TYPE	FROM SUBNET A	FROM SUBNET B
E-mail	64 Kbps	64 Kbps
Video	64 Kbps	64 Kbps

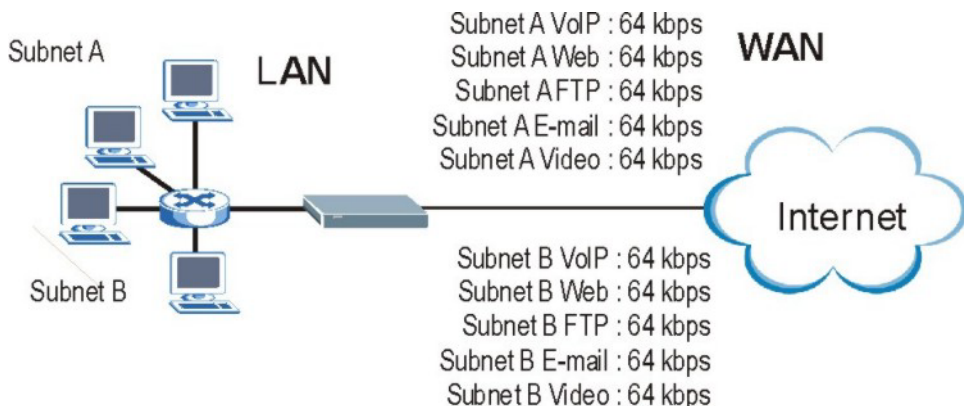
**Figure 12-5 Application and Subnet-based Bandwidth Management Example**

12.7 Alerts

Alerts are reports on events, such as attacks, that you may want to know about right away. You can choose to generate an alert when an attack is detected in the **Attack Alert** screen (*Figure 12-16* - check the **Generate alert when attack detected** checkbox) or when a rule is matched in the **Edit Rule** screen (see *Figure 12-7*).

Configure the **Log Settings** screen to have the ZyWALL send an immediate e-mail message to you when an event generates an alert. Refer to the chapter on logs for details.

12.8 Configuring Firewall

The ordering of your rules is very important as rules are applied in turn.

Click **FIREWALL** to open the **Summary** screen. Enable (or activate) the firewall by selecting the **Enable Firewall** check box as seen in the following screen.

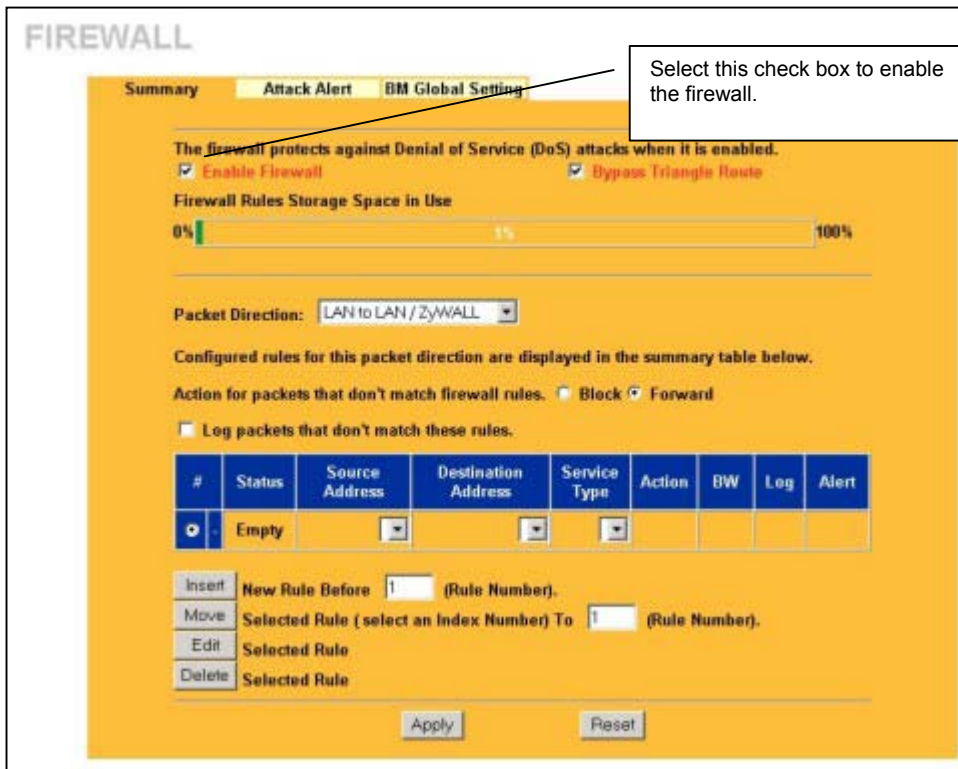

Figure 12-6 Firewall Summary

The following table describes the labels in this screen.

Table 12-2 Firewall Summary

LABEL	DESCRIPTION
Enable Firewall	Select this check box to activate the firewall. The ZyWALL performs access control and protects against Denial of Service (DoS) attacks when the firewall is activated.
Bypass Triangle Route	Select this check box to have the ZyWALL firewall ignore the use of triangle route topology on the network. See the <i>Appendices</i> for more on triangle route topology.
Firewall Rules Storage Space in Use	This read-only bar shows how much of the ZyWALL's memory for recording firewall rules it is currently using. When you are using 80% or less of the storage space, the bar is green. When the amount of space used is over 80%, the bar is red.

Table 12-2 Firewall Summary

LABEL	DESCRIPTION
Packet Direction	Use the drop-down list box to select a direction of travel of packets (LAN to LAN/ZyWALL , LAN to WAN , LAN to DMZ , WAN to WAN/ZyWALL , WAN to LAN , WAN to DMZ , DMZ to DMZ/ZyWALL , DMZ to LAN or DMZ to WAN) for which you want to configure firewall rules.
Block/Forward	Use the option buttons to select whether to Block (silently discard) or Forward (allow the passage of) packets that are traveling in the selected direction.
Log	Select the check box to create a log (when the above action is taken) for packets that are traveling in the selected direction and do not match any of the rules below.
The following read-only fields summarize the rules you have created that apply to traffic traveling in the selected packet direction. The firewall rules that you configure (summarized below) take priority over the general firewall action settings above.	
Index	This is your firewall rule number. The ordering of your rules is important as rules are applied in turn. The Move field below allows you to reorder your rules.
Status	This field displays whether a firewall is turned on (Active) or not (Inactive). Rules that have not been configured display Empty .
Source Address	This drop-down list box displays the source addresses or ranges of addresses to which this firewall rule applies. Please note that a blank source or destination address is equivalent to Any .
Destination Address	This drop-down list box displays the destination addresses or ranges of addresses to which this firewall rule applies. Please note that a blank source or destination address is equivalent to Any .
Service Type	This drop-down list box displays the services to which this firewall rule applies. Please note that a blank service type is equivalent to Any . See <i>Table 12-7</i> for more information.
Action	This is the specified action for that rule, either Block or Forward . Note that Block means the firewall silently discards the packet.
BW	This field shows the maximum bandwidth (in kilobits per second) that the ZyWALL allocates to the traffic that matches this firewall rule. This field displays N/A if the rule does not have bandwidth management enabled.
Log	This field shows you if a log is created for packets that match the rule (Match), don't match the rule (Not Match), both (Both) or no log is created (None).
Alert	This field tells you whether this rule generates an alert (Yes) or not (No) when the rule is matched.

Table 12-2 Firewall Summary

LABEL	DESCRIPTION
Insert	Type the index number for where you want to put a rule. For example, if you type “6”, your new rule becomes number 6 and the previous rule 6 (if there is one) becomes rule 7. Click Insert to display this screen and refer to the following table for information on the fields.
Move	Select a rule’s Index option button and type a number for where you want to put that rule. Click Move to move the rule to the number that you typed. The ordering of your rules is important as they are applied in order of their numbering.
Rule to (Rule Number)	Click a rule’s option button and type the number for where you want to put that rule.
Edit	Click Edit to create or edit a rule.
Delete	Click Delete to delete an existing firewall rule. Note that subsequent firewall rules move up by one when you take this action.
Apply	Click Apply to save your changes back to the ZyWALL.
Reset	Click Reset to begin configuring this screen afresh.

12.8.1 Configuring Firewall Rules

Follow these directions to create a new rule.

- Step 1.** In the **Summary** screen, type the index number for where you want to put the rule. For example, if you type “6”, your new rule becomes number 6 and the previous rule 6 (if there is one) becomes rule 7.
- Step 2.** Click **Insert** to display this screen and refer to the following table for information on the fields.

Figure 12-7 Firewall Edit Rule

The following table describes the labels in this screen.

Table 12-3 Firewall Edit Rule

LABEL	DESCRIPTION
Active	Check the Active check box to have the ZyWALL use this rule. Leave it unchecked if you do not want the ZyWALL to use the rule after you apply it
Packet Direction	Use the drop-down list box to select the direction of packet travel to which you want to apply this firewall rule.
Source Address	Click SrcAdd to add a new address, SrcEdit to edit an existing one or SrcDelete to delete one. Please see the next section for more information on adding and editing source addresses.

Table 12-3 Firewall Edit Rule

LABEL	DESCRIPTION
Destination Address	Click DestAdd to add a new address, DestEdit to edit an existing one or DestDelete to delete one. Please see the following section on adding and editing destination addresses.
Available/ Selected Services	Please see <i>Table 12-7</i> for more information on services available. Highlight a service from the Available Services box on the left, then click >> to add it to the Selected Services box on the right. To remove a service, highlight it in the Selected Services box on the right, then click <<.
Custom Port	
Add	Click this button to bring up the screen that you use to configure a new custom service that is not in the predefined list of services.
Edit	Select a custom service (denoted by an “*”) from the Available Services list and click this button to edit the service.
Delete	Select a custom service (denoted by an “*”) from the Available Services list and click this button to remove the service.
Action for Matched Packets	Use the drop down list box to select whether to discard (Block) or allow the passage of (Forward) packets that match this rule.
Log	This field determines if a log is created for packets that match the rule (Match), don't match the rule (Not Match), both (Both) or no log is created (None). Go to the Log Settings page and select the Access Control logs category to have the ZyWALL record these logs.
Alert	Check the Alert check box to determine that this rule generates an alert when the rule is matched.
Apply Bandwidth Management	<p>Select this check box to have the ZyWALL apply bandwidth management to traffic that matches this firewall rule. Bandwidth for traffic that matches this firewall rule is limited to the amount that you configure in the Bandwidth for This Rule field. The ZyWALL gives traffic that matches this firewall rule priority over traffic that does not match a firewall rule with bandwidth management.</p> <p>To have the ZyWALL apply bandwidth management, you must also enable bandwidth management in the BM Global Setting screen.</p>

Table 12-3 Firewall Edit Rule

LABEL	DESCRIPTION
<p>Bandwidth for This Rule</p>	<p>Enter the maximum amount of bandwidth (in Kbps) that you want to allocate for the traffic that matches this firewall rule. The traffic that matches this rule cannot use more bandwidth than you specify here.</p> <p>The ZyWALL applies bandwidth management to traffic that it forwards out through an interface. The ZyWALL does not control the bandwidth of traffic that comes into an interface.</p> <p>Bandwidth management applies to all traffic flowing out of the router through the interface, regardless of the traffic's source.</p> <p>Traffic redirect or IP alias may cause LAN-to-LAN or DMZ-to-DMZ traffic to pass through the ZyWALL and be managed by bandwidth management.</p> <p>For LAN to WAN and WAN to LAN rules, the amount of bandwidth that you configure applies separately to LAN to WAN traffic and WAN to LAN traffic. For example, configure a LAN to WAN rule for 64kbps and the ZyWALL allocates 64 kbps for traffic that it forwards from the LAN to the WAN and 64 kbps for traffic that it forwards from the WAN to the LAN.</p> <p>For LAN to LAN/ZyWALL rules, the amount of bandwidth that you configure applies to the traffic that the ZyWALL forwards from the LAN or the ZyWALL to the LAN.</p> <p>For WAN to WAN/ZyWALL rules, the amount of bandwidth that you configure applies to the traffic that the ZyWALL forwards from the WAN or the ZyWALL to the WAN.</p> <p>The minimum bandwidth for an individual firewall rule is 2 kbps. 20 kbps to 20,000 kbps is recommended.</p> <p>The sum of the bandwidth allotments for firewall rules that apply to the WAN port (WAN to LAN, LAN to WAN, WAN to WAN / ZyWALL) must be less than or equal to the WAN Port Speed that you configure in the BM Global Setting screen.</p> <p>The sum of the bandwidth allotments for firewall rules that apply to the LAN port (LAN to WAN, WAN to LAN, LAN to LAN / ZyWALL) must be less than or equal to 100,000 kbps (you cannot configure the bandwidth management global setting for the LAN port speed).</p>
Apply	Click Apply to save your customized settings and exit this screen.
Cancel	Click Cancel to exit this screen without saving,

12.8.2 Configuring Source and Destination Addresses

To add a new source or destination address, click **SrcAdd** or **DestAdd** from the previous screen. To edit an existing source or destination address, select it from the box and click **SrcEdit** or **DestEdit** from the previous screen. Either action displays the following screen.

Figure 12-8 Source and Destination Addresses Add/Edit

The following table describes the labels in this screen.

Table 12-4 Source and Destination Addresses Add/Edit

LABEL	DESCRIPTION
Address Type	Do you want your rule to apply to packets with a particular (single) IP, a range of IP addresses (e.g., 192.168.1.10 to 192.169.1.50), a subnet or any IP address? Select an option from the drop-down list box that includes: Single Address , Range Address , Subnet Address and Any Address .
Start IP Address	Enter the single IP address or the starting IP address in a range here.
End IP Address	Enter the ending IP address in a range here.
Subnet Mask	Enter the subnet mask here, if applicable.
Apply	Click Apply to save your customized settings and exit this screen.
Cancel	Click Cancel to exit this screen without saving.

12.8.3 Configuring Custom Ports

Configure customized ports for services not predefined by the ZyWALL (see *section 12.10* for a list of predefined services). For a comprehensive list of port numbers and services, visit the IANA (Internet Assigned Number Authority) web site.

Click the **Add** button under **Custom Port** while editing a firewall to configure a custom port. This displays the following screen.

Figure 12-9 Custom Port Create/Edit

The following table describes the labels in this screen.

Table 12-5 Custom Port Create/Edit

LABEL	DESCRIPTION
Service Name	Enter a unique name for your custom port.
Service Type	Choose the IP port (TCP , UDP or Both) that defines your customized port from the drop down list box.
Port Configuration Type	Click Single to specify one port only or Range to specify a span of ports that define your customized service.
Port Number	Enter a single port number or the range of port numbers that define your customized service.
Apply	Click Apply to save your customized settings and exit this screen.
Cancel	Click Cancel to exit this screen without saving,

12.8.4 Bandwidth for Traffic that Does Not Match Firewall Rules

Use one of the following methods to configure the ZyWALL to allow bandwidth for traffic that does not match firewall rules with bandwidth management enabled.

1. Set the bandwidth management global WAN port speed to less than the speed of the broadband device connected to the WAN port.
2. Configure the firewall rules so that the sum of their bandwidth allotments is less than or equal to the bandwidth management global setting.

- a. For firewall rules that apply to the WAN port (WAN to LAN, LAN to WAN, WAN to WAN / ZyWALL), you can configure the WAN port's bandwidth management global setting in the following screen.
- b. For firewall rules that apply to the LAN port (LAN to WAN, WAN to LAN, LAN to LAN / ZyWALL), the LAN port's bandwidth management global setting is fixed at 100,000 kbps.

12.8.5 Configuring BM Global Settings

To change your ZyWALL's global bandwidth management settings, click **Firewall**, then the **BM Global Setting** tab. The screen appears as shown.



Figure 12-10 BM Global Setting

The following table describes the labels in this screen.

Table 12-6 BM Global Setting

LABEL	DESCRIPTION
Enable Bandwidth Management	<p>Select this check box to have the ZyWALL apply bandwidth management to traffic going out through the ZyWALL's WAN or LAN port.</p> <p>Enable bandwidth management to give traffic that matches firewall rules that use bandwidth management priority over traffic that does not match a firewall rule that uses bandwidth management.</p> <p>Enable bandwidth management to be able to control the maximum amounts of bandwidth that can be used by traffic that matches firewall rules that are configured for bandwidth management.</p>

Table 12-6 BM Global Setting

LABEL	DESCRIPTION
WAN Port Speed	<p>Enter the amount of bandwidth in kbps (2 to 100,000) that you want to allocate for traffic that matches LAN to WAN, WAN to LAN and WAN to WAN / ZyWALL firewall rules with bandwidth management enabled.</p> <p>The recommendation is to set this speed to be equal to or less than the speed of the broadband device connected to the WAN port. For example, set the speed to 1000 Kbps (or less) if the broadband device connected to the WAN port has an upstream speed of 1000 Kbps.</p> <p>If you have already configured firewall rules (that apply to the WAN port) with bandwidth allotments, you must set this field to be equal to or greater than the sum of the firewall rules' bandwidth allotments.</p>
Apply	Click Apply to save your customized settings and exit this screen.
Reset	Click Reset to begin configuring this screen afresh.

12.9 Example Firewall Rule

The following Internet firewall rule example allots 64Kbps for a hypothetical “My Service” connection from the Internet to IP addresses 10.0.0.10 to 10.0.0.15 on the LAN.

- Step 1.** Click the **Firewall** link and then the **Summary** tab.
- Step 2.** In the **Summary** screen, type the index number for where you want to put the rule. For example, if you type “6”, your new rule becomes number 6 and the previous rule 6 (if there is one) becomes rule 7.
- Step 3.** Click **Insert** to display the firewall rule configuration screen.

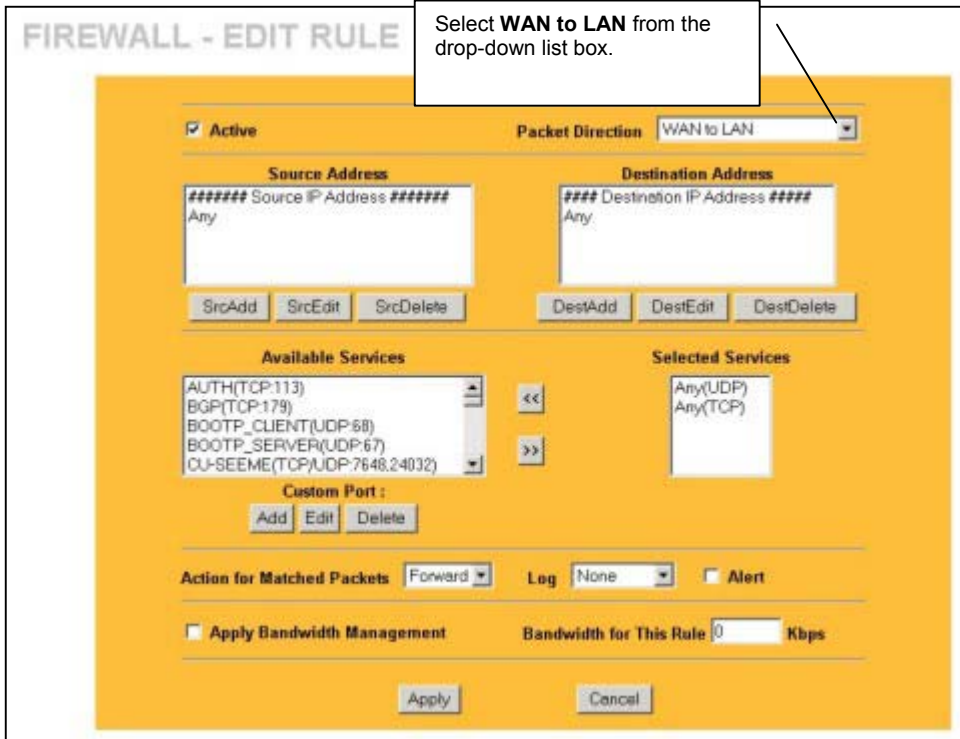

Figure 12-11 Firewall Edit Rule Screen

Step 4. Select Any in the Destination Address box and then click **DestEdit**.

Step 5. Configure the **Firewall Rule Edit IP** screen as follows and click **Apply**.



Figure 12-12 Firewall Rule Edit IP Example

- Step 6.** In the firewall rule configuration screen, click **Add** under **Custom Port** to open the **Edit Custom Port** screen. Configure it as follows and click **Apply**.



The screenshot shows the 'FIREWALL - EDIT RULE - EDIT CUSTOM PORT' configuration window. It features a yellow background and the following fields and controls:

- Service Name:** A text input field containing 'My Service'.
- Service Type:** A dropdown menu set to 'TCP/UDP'.
- Port Configuration:**
 - Type:** Two radio buttons, with 'Single' selected and 'Range' unselected.
 - Port Number:** Two input fields, the first containing '123' and the second containing '0'.
- Buttons:** 'Apply' and 'Cancel' buttons at the bottom.

Figure 12-13 Edit Custom Port Example

- Step 8.** The firewall rule configuration screen displays, use the arrows between **Available Services** and **Selected Services** to configure it as shown in the following screen.
- Step 9.** Select the **Apply Bandwidth Management** check box and configure the **Bandwidth for This Rule** field to "64".
- Step 10.** Click **Apply** when you are done.

Custom ports show up with an “*” before their names in the Services list box and the Rule Summary list box. Click Apply after you’ve created your custom port.

The screenshot shows the 'FIREWALL - EDIT RULE' configuration interface. The 'Active' checkbox is checked. The 'Packet Direction' is set to 'WAN to LAN'. The 'Source Address' is 'Any'. The 'Destination Address' is '10.0.0.10 - 10.0.0.15'. The 'Available Services' list includes 'BOOTP_CLIENT(UDP:68)'. The 'Selected Services' list includes '*My Service(TCP,UDP:123)'. The 'Custom Port' section has 'Add', 'Edit', and 'Delete' buttons. The 'Action for Matched Packets' is 'Forward', 'Log' is 'None', and 'Alert' is unchecked. The 'Apply Bandwidth Management' checkbox is checked, and the 'Bandwidth for This Rule' is set to '64 Kbps'. The 'Apply' and 'Cancel' buttons are at the bottom.

This is the address range of the "MyService" servers.

Select this check box.

This is your "MyService" custom port.

Type "64" in this field.

Click **Apply** when finished.

Figure 12-14 My Service Rule Configuration

On completing the configuration procedure for this Internet firewall rule, the **Rule Summary** screen should look like the following. Remember to click **Apply** when you have finished configuring your rule(s) to save your settings back to the ZyWALL.

The screenshot shows the 'FIREWALL' configuration interface. The 'Summary' tab is selected. The main area is yellow and contains the following information:

- Summary: The firewall protects against Denial of Service (DoS) attacks when it is enabled.
- Enable Firewall: (checked)
- Bypass Triangle Route: (checked)
- Firewall Rules Storage Space In Use: 0% (0% bar) to 100% (100% bar)
- Packet Direction: WAN to LAN (dropdown menu)
- Configured rules for this packet direction are displayed in the summary table below.
- Action for packets that don't match firewall rules: Block Forward
- Log packets that don't match these rules: (checked)

#	Status	Source Address	Destination Address	Service Type	Action	BW	Log	Alert
1	Active	Any	10.0.0.10 - 10.0.0.15	*My Service(TCP/UDP:123)	Forward	64	None	No
2	Inactive	Any	Any	NetBIOS(TCP/UDP:137**139,445)	Forward	N/A	None	No

Below the table are buttons for 'Insert', 'Move', 'Edit', and 'Delete', each followed by 'Selected Rule'. At the bottom are 'Apply' and 'Reset' buttons.

Rule 1: Allows a "My Service" connection from the WAN to IP addresses 10.0.0.10 through 10.0.0.15 on the LAN.

Click **Apply** to save your settings back to the ZyWALL.

Figure 12-15 My Service Example Rule Summary

12.10 Predefined Services

The **Available Services** list box in the **Edit Rule** screen (see *Figure 12-7*) displays all predefined services that the ZyWALL already supports. Next to the name of the service, two fields appear in brackets. The first field indicates the IP protocol type (TCP, UDP, or ICMP). The second field indicates the IP port number that

defines the service. (Note that there may be more than one IP protocol type. For example, look at the default configuration labeled “(DNS)”. (UDP/TCP:53) means UDP port 53 and TCP port 53. Custom services may also be configured using the **Custom Ports** function discussed later.

Table 12-7 Predefined Services

SERVICE	DESCRIPTION
AIM/New-ICQ(TCP:5190)	AOL's Internet Messenger service, used as a listening port by ICQ.
AUTH(TCP:113)	Authentication protocol used by some servers.
BGP(TCP:179)	Border Gateway Protocol.
BOOTP_CLIENT(UDP:68)	DHCP Client.
BOOTP_SERVER(UDP:67)	DHCP Server.
CU-SEEME(TCP/UDP:7648, 24032)	A popular videoconferencing solution from White Pines Software.
DNS(UDP/TCP:53)	Domain Name Server, a service that matches web names (e.g. www.zyxel.com) to IP numbers.
FINGER(TCP:79)	Finger is a UNIX or Internet related command that can be used to find out if a user is logged on.
FTP(TCP:20.21)	File Transfer Program, a program to enable fast transfer of files, including large files that may not be possible by e-mail.
H.323(TCP:1720)	NetMeeting uses this protocol.
HTTP(TCP:80)	Hyper Text Transfer Protocol - a client/server protocol for the world wide web.
HTTPS(TCP:443)	HTTPS is a secured http session often used in e-commerce.
ICQ(UDP:4000)	This is a popular Internet chat program.
IKE(UDP:500)	The Internet Key Exchange algorithm is used for key distribution and management.
IPSEC_TUNNEL(AH:0)	The IPSEC AH (Authentication Header) tunneling protocol uses this service.
IPSEC_TUNNEL(ESP:0)	The IPSEC ESP (Encapsulation Security Protocol) tunneling protocol uses this service.
IRC(TCP/UDP:6667)	This is another popular Internet chat program.

Table 12-7 Predefined Services

SERVICE	DESCRIPTION
MSN Messenger(TCP:1863)	Microsoft Networks' messenger service uses this protocol.
MULTICAST(IGMP:0)	Internet Group Multicast Protocol is used when sending packets to a specific group of hosts.
NEW-ICQ(TCP:5190)	An Internet chat program.
NEWS(TCP:144)	A protocol for news groups.
NFS(UDP:2049)	Network File System - NFS is a client/server distributed file service that provides transparent file sharing for network environments.
NNTP(TCP:119)	Network News Transport Protocol is the delivery mechanism for the USENET newsgroup service.
PING(ICMP:0)	Packet Internet Groper is a protocol that sends out ICMP echo requests to test whether or not a remote host is reachable.
POP3(TCP:110)	Post Office Protocol version 3 lets a client computer get e-mail from a POP3 server through a temporary connection (TCP/IP or other).
PPTP(TCP:1723)	Point-to-Point Tunneling Protocol enables secure transfer of data over public networks. This is the control channel.
PPTP_TUNNEL(GRE:0)	Point-to-Point Tunneling Protocol enables secure transfer of data over public networks. This is the data channel.
RCMD(TCP:512)	Remote Command Service.
REAL_AUDIO(TCP:7070)	A streaming audio service that enables real time sound over the web.
REXEC(TCP:514)	Remote Execution Daemon.
RLOGIN(TCP:513)	Remote Login.
RTELNET(TCP:107)	Remote Telnet.
RTSP(TCP/UDP:554)	The Real Time Streaming (media control) Protocol (RTSP) is a remote control for multimedia on the Internet.
SFTP(TCP:115)	Simple File Transfer Protocol.
SMTP(TCP:25)	Simple Mail Transfer Protocol is the message-exchange standard for the Internet. SMTP enables you to move messages from one e-mail server to another.
SNMP(TCP/UDP:161)	Simple Network Management Program.

Table 12-7 Predefined Services

SERVICE	DESCRIPTION
SNMP-TRAPS(TCP/UDP:162)	Traps for use with the SNMP (RFC:1215).
SQL-NET(TCP:1521)	Structured Query Language is an interface to access data on many different types of database systems, including mainframes, midrange systems, UNIX systems and network servers.
SSH(TCP/UDP:22)	Secure Shell Remote Login Program.
STRM WORKS(UDP:1558)	Stream Works Protocol.
SYSLOG(UDP:514)	Syslog allows you to send system logs to a UNIX server.
TACACS(UDP:49)	Login Host Protocol used for (Terminal Access Controller Access Control System).
TELNET(TCP:23)	Telnet is the login and terminal emulation protocol common on the Internet and in UNIX environments. It operates over TCP/IP networks. Its primary function is to allow users to log into remote host systems.
TFTP(UDP:69)	Trivial File Transfer Protocol is an Internet file transfer protocol similar to FTP, but uses the UDP (User Datagram Protocol) rather than TCP (Transmission Control Protocol).
VDOLIVE(TCP:7000)	Another videoconferencing solution.

12.11 Configuring Attack Alert

Attack alerts are the first defense against DOS attacks. In the **Attack Alert** screen, shown later, you may choose to generate an alert whenever an attack is detected. For DoS attacks, the ZyWALL uses thresholds to determine when to drop sessions that do not become fully established. These thresholds apply globally to all sessions.

You can use the default threshold values, or you can change them to values more suitable to your security requirements.

12.11.1 Threshold Values

Tune these parameters when something is not working and after you have checked the firewall counters. These default values should work fine for normal small offices with ADSL bandwidth. Factors influencing choices for threshold values are:

1. The maximum number of opened sessions.

2. The minimum capacity of server backlog in your LAN network.
3. The CPU power of servers in your LAN network.
4. Network bandwidth.
5. Type of traffic for certain servers.

If your network is slower than average for any of these factors (especially if you have servers that are slow or handle many tasks and are often busy), then the default values should be reduced.

You should make any changes to the threshold values before you continue configuring firewall rules.

12.11.2 Half-Open Sessions

An unusually high number of half-open sessions (either an absolute number or measured as the arrival rate) could indicate that a Denial of Service attack is occurring. For TCP, "half-open" means that the session has not reached the established state—the TCP three-way handshake has not yet been completed (see *Figure 11-2*). For UDP, "half-open" means that the firewall has detected no return traffic.

The ZyWALL measures both the total number of existing half-open sessions and the rate of session establishment attempts. Both TCP and UDP half-open sessions are counted in the total number and rate measurements. Measurements are made once a minute.

When the number of existing half-open sessions rises above a threshold (**max-incomplete high**), the ZyWALL starts deleting half-open sessions as required to accommodate new connection requests. The ZyWALL continues to delete half-open requests as necessary, until the number of existing half-open sessions drops below another threshold (**max-incomplete low**).

When the rate of new connection attempts rises above a threshold (**one-minute high**), the ZyWALL starts deleting half-open sessions as required to accommodate new connection requests. The ZyWALL continues to delete half-open sessions as necessary, until the rate of new connection attempts drops below another threshold (**one-minute low**). The rate is the number of new attempts detected in the last one-minute sample period.

TCP Maximum Incomplete and Blocking Time

An unusually high number of half-open sessions with the same destination host address could indicate that a Denial of Service attack is being launched against the host.

Whenever the number of half-open sessions with the same destination host address rises above a threshold (**TCP Maximum Incomplete**), the ZyWALL starts deleting half-open sessions according to one of the following methods:

1. If the **Blocking Time** timeout is 0 (the default), then the ZyWALL deletes the oldest existing half-open session for the host for every new connection request to the host. This ensures that the number of half-open sessions to a given host will never exceed the threshold.

- If the **Blocking Time** timeout is greater than 0, then the ZyWALL blocks all new connection requests to the host giving the server time to handle the present connections. The ZyWALL continues to block all new connection requests until the **Blocking Time** expires.

The ZyWALL also sends alerts whenever **TCP Maximum Incomplete** is exceeded. The global values specified for the threshold and timeout apply to all TCP connections. Click the **Attack Alert** tab to bring up the next screen.

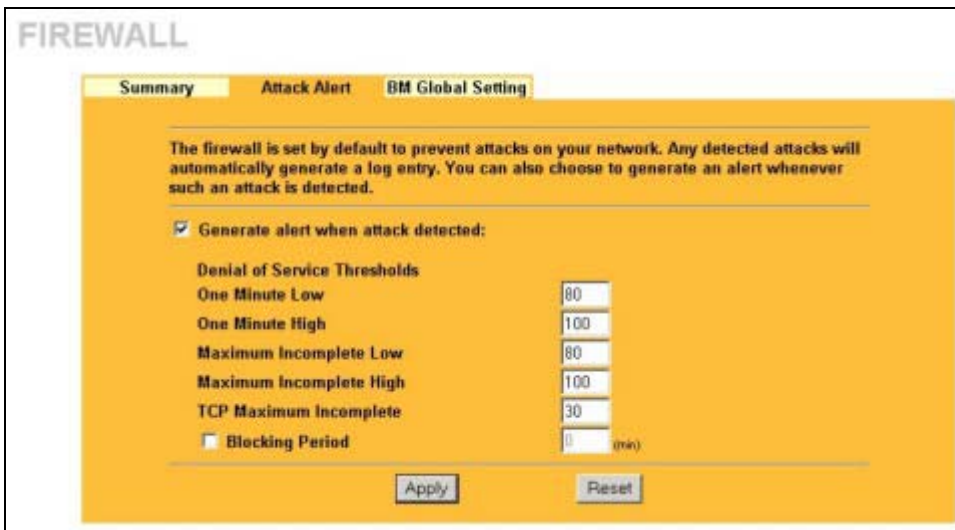

Figure 12-16 Attack Alert

The following table describes the labels in this screen.

Table 12-8 Attack Alert

LABEL	DESCRIPTION	DEFAULT VALUES
Generate alert when attack detected	A detected attack automatically generates a log entry. Check this box to generate an alert (as well as a log) whenever an attack is detected. See the chapter on logs for more information on logs and alerts.	
Denial of Service Thresholds		

Table 12-8 Attack Alert

LABEL	DESCRIPTION	DEFAULT VALUES
One Minute Low	This is the rate of new half-open sessions that causes the firewall to stop deleting half-open sessions. The ZyWALL continues to delete half-open sessions as necessary, until the rate of new connection attempts drops below this number.	80 existing half-open sessions.
One Minute High	This is the rate of new half-open sessions that causes the firewall to start deleting half-open sessions. When the rate of new connection attempts rises above this number, the ZyWALL deletes half-open sessions as required to accommodate new connection attempts.	100 half-open sessions per minute. The above numbers cause the ZyWALL to start deleting half-open sessions when more than 100 session establishment attempts have been detected in the last minute, and to stop deleting half-open sessions when fewer than 80 session establishment attempts have been detected in the last minute.
Maximum Incomplete Low	This is the number of existing half-open sessions that causes the firewall to stop deleting half-open sessions. The ZyWALL continues to delete half-open requests as necessary, until the number of existing half-open sessions drops below this number.	80 existing half-open sessions.
Maximum Incomplete High	This is the number of existing half-open sessions that causes the firewall to start deleting half-open sessions. When the number of existing half-open sessions rises above this number, the ZyWALL deletes half-open sessions as required to accommodate new connection requests. Do not set Maximum Incomplete High to lower than the current Maximum Incomplete Low number.	100 existing half-open sessions. The above values causes the ZyWALL to start deleting half-open sessions when the number of existing half-open sessions rises above 100, and to stop deleting half-open sessions with the number of existing half-open sessions drops below 80.

Table 12-8 Attack Alert

LABEL	DESCRIPTION	DEFAULT VALUES
TCP Maximum Incomplete	This is the number of existing half-open TCP sessions with the same destination host IP address that causes the firewall to start dropping half-open sessions to that same destination host IP address. Enter a number between 1 and 256. As a general rule, you should choose a smaller number for a smaller network, a slower system or limited bandwidth.	10 existing half-open TCP sessions (30 in the ZyWALL 10W, 30W and 100).
Blocking Time	When TCP Maximum Incomplete is reached you can choose if the next session should be allowed or blocked. If you check Blocking Time any new sessions will be blocked for the length of time you specify in the next field (min) and all old incomplete sessions will be cleared during this period. If you want strong security, it is better to block the traffic for a short time, as it will give the server some time to digest the loading.	Select this check box to specify a number in minutes (min) text box.
(min)	Enter the length of Blocking Time in minutes.	0
Apply	Click Apply to save your changes back to the ZyWALL.	
Reset	Click Reset to begin configuring this screen afresh.	

Chapter 13

Content Filtering Screens

This chapter provides an overview of content filtering.

13.1 Content Filtering Overview

Content filtering allows you to block certain web features, such as Cookies, and/or restrict specific websites. With content filtering, you can do the following:

13.1.1 Restrict Web Features

The ZyWALL can block web features such as ActiveX controls, Java applets, cookies and disable web proxies.

13.1.2 Create a Filter List

You can select categories, such as pornography or racial intolerance, to block from a pre-defined list.

13.1.3 Filter Specific Web Sites

Your ZyWALL can block or allow access to specific web sites based on their URLs or based on certain key words contained in web site content.

13.2 General Content Filter Configuration

Click **CONTENT FILTER** to open the **CONTENT FILTERING** screen. The **General** tab displays as shown. Use this screen to enable content filtering, configure a schedule, and create a denial message. You can also choose specific computers to be included in or excluded from the content filtering configuration.

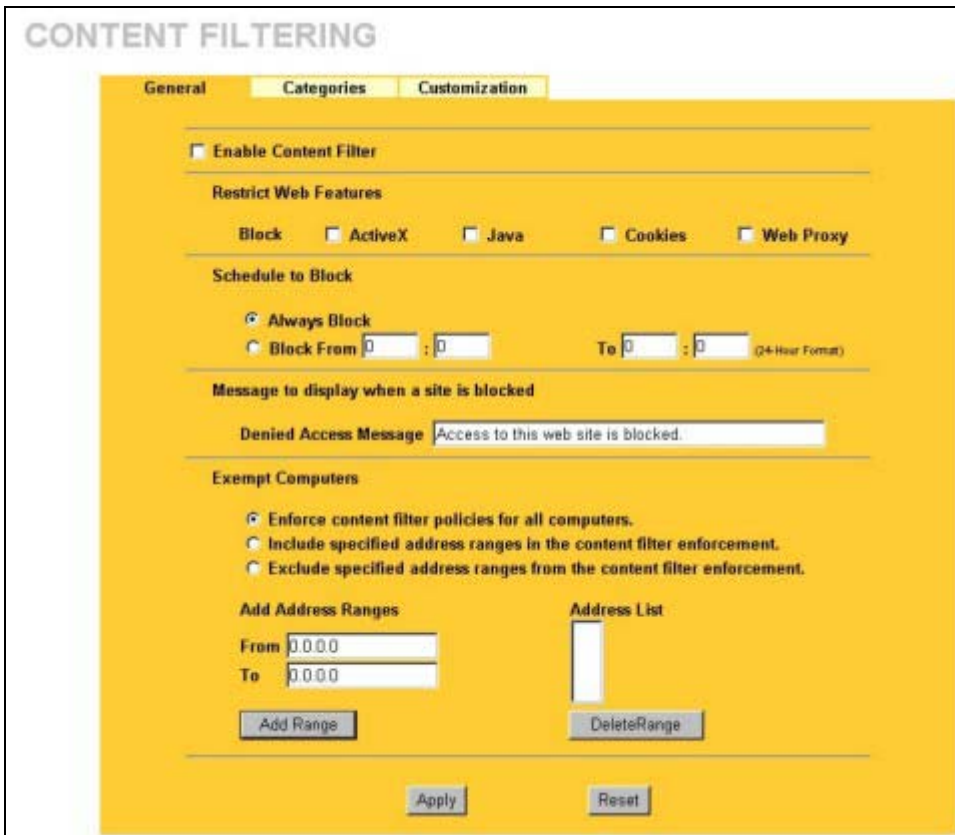

Figure 13-1 Content Filtering General

The following table describes the labels in this screen.

Table 13-1 Content Filtering General

LABEL	DESCRIPTION
Enable Content Filter	Select this check box to enable the content filter.
Restricted Web Features	Select the check box(es) to restrict a feature. When you download a page containing a restricted feature, that part of the web page will appear blank or grayed out.

Table 13-1 Content Filtering General

LABEL	DESCRIPTION
Block ActiveX	Active X is a tool for building dynamic and active web pages and distributed object applications. When you visit an ActiveX web site, ActiveX controls are downloaded to your browser, where they remain in case you visit the site again.
Java	Java is a programming language and development environment for building downloadable Web components or Internet and intranet business applications of all kinds.
Cookies	Cookies are files stored on a computer's hard drive. Some web servers use them to track usage and provide service based on ID.
Web Proxy	A server that acts as an intermediary between a user and the Internet to provide security, administrative control, and caching service. When a proxy server is located on the WAN it is possible for LAN users to circumvent content filtering by pointing to this proxy server.
Schedule to Block	Content filtering scheduling only applies to the Filter List, Customized sites and Keywords. Restricted web server data, such as ActiveX, Java, Cookies and Web Proxy are not affected.
Always Block	Click this option button to have content filtering always active with Time of Day limitations not enforced. This is enabled by default.
Block From/To	Click this option button to have content filtering only active during the time interval specified. In the Block From and To fields, enter the time period, in 24-hour format, during which content filtering will be enforced. The ZyWALL does not perform content filtering if you set both of these fields to 0 (the default).
Message to display when a site is blocked	
Denied Access Message	Enter a message to be displayed when a user tries to access a restricted web site. The default message is "Please contact your network administrator!!"
Exempt Computers	
Enforce content filter policies for all computers	Select this checkbox to have all users on your LAN follow content filter policies (default).
Include specified address ranges in the content filter enforcement	Select this checkbox to have a specific range of users on your LAN follow content filter policies.

Table 13-1 Content Filtering General

LABEL	DESCRIPTION
Exclude specified address ranges from the content filter enforcement	Select this checkbox to exempt a specific range of users on your LAN from content filter policies.
Add Address Ranges	
From	Type the beginning IP address (in dotted decimal notation) of the specific range of users on your LAN.
To	Type the ending IP address (in dotted decimal notation) of the specific range of users on your LAN, then click Add Range .
Address List	This text field shows the address ranges that are blocked.
Add Range	Click Add Range after you have filled in the From and To fields above.
Delete Range	Click Delete Range after you select the range of addresses you wish to delete.
Apply	Click Apply to save your changes back to the ZyWALL.
Reset	Click Reset to begin configuring this screen afresh.

13.3 Content Filtering with an External Server

Your ZyWALL uses an application services company that provides outsourced content filtering. If you enable the content filter, your ZyWALL will have access to an external database, which contains dynamically updated ratings of millions of web sites. The content filtering lookup process is described below.

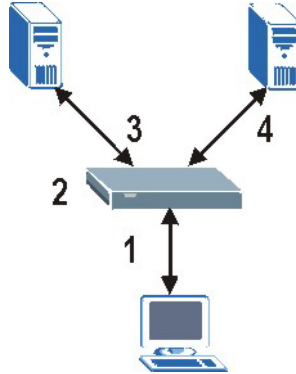

Figure 13-2 Content Filtering Lookup Procedure

- Step 1.** A computer sends an HTTP request to a web server.
- Step 2.** The ZyWALL looks up the web site in its local database. If an attempt to access the web site was made in the past, a record of that web site's rating will be in the ZyWALL's cache. The ZyWALL either blocks or forwards the request based on the rating policy you configure.

If the ZyWALL doesn't have a record of the web site, it will query the lookup server and simultaneously send the request to the web server.

- Step 3.** The lookup server sends the rating information back to the ZyWALL, which then either forwards or blocks the web content. The web site address is then also stored in the ZyWALL's content filtering cache.

13.4 A Procedure to Enable External Database Content Filtering

The following is an example procedure for using external database content filtering.

- Step 1.** Enable content filtering in the **Content Filtering General** screen.
- Step 2.** In the **Content Filtering Categories** screen, register for external database content filtering.
- Step 3.** In the **Content Filtering Categories** screen, select **Enable External Database Content Filtering**.
- Step 4.** In the **Content Filtering Categories** screen, select **Block Matched Web Pages**.
- Step 5.** In the **Content Filtering Categories** screen, select categories to block.

13.5 Checking Content Filtering Activation

After you register for content filtering, the web site displays a registration successful web page. This does not mean the content filtering is active yet. You need to wait up to ten minutes for the content filtering to be activated.

Since there will be no activation notice, do the following:

- Step 1.** Go to your device's web configurator's **Content Filtering, Categories** screen.
- Step 2.** Select at least one category and click **Apply**.
- Step 3.** Enter a valid URL or IP address of a web site in the **Test if Web site is blocked** field and click the **Test Against Internet Server** button.
When content filtering is active, you should see an access blocked or access forwarded message. An error message displays if content filtering is not active.

13.6 Configuring Categories

To register for and configure category-based content filtering, click **CONTENT FILTER**, and then the **Categories** tab. The screen appears as shown.

CONTENT FILTERING

General
Categories
Customization

Enable External Database Content Filtering

<input checked="" type="checkbox"/> Block	<input checked="" type="checkbox"/> Log	Matched Web Pages
<input checked="" type="checkbox"/> Block	<input checked="" type="checkbox"/> Log	Unrated Web Pages
<input checked="" type="checkbox"/> Block	<input checked="" type="checkbox"/> Log	When Content Filter Server Is Unavailable
		Content Filter Server Unavailable Timeout <input style="width: 50px;" type="text" value="10"/> (1-30 seconds)

Select Categories

Select All Categories Clear All Categories

<input type="checkbox"/> Adult/Mature Content Intimate	<input type="checkbox"/> Pornography	<input type="checkbox"/> Sex Education
<input type="checkbox"/> Apparel/Swimsuit	<input type="checkbox"/> Nudity	<input type="checkbox"/> Alcohol/Tobacco
<input type="checkbox"/> Illegal/Questionable	<input type="checkbox"/> Gambling	<input type="checkbox"/> Violence/Hate/Racism
<input type="checkbox"/> Weapons	<input type="checkbox"/> Abortion	<input type="checkbox"/> Arts/Entertainment
<input type="checkbox"/> Business/Economy	<input type="checkbox"/> Cult/Occult	<input type="checkbox"/> Illegal Drugs

Test Web Site Attribute:

Test if Web site is blocked (Domain name or IP Address)

Registration and Reports

Click [Register](#) to register for external content filtering. You can use a trial application or register your iCard's PIN. You can also view and update your registration status or view content filtering reports.

Registration Status: **Unregistered**

Figure 13-3 Content Filtering Categories

The following table describes the labels in this screen.

Table 13-2 Content Filtering Categories

LABEL	DESCRIPTION
Enable External Database Content Filtering	Enable external database content filtering to have the ZyWALL check an external database to find to which category a requested web page belongs. The ZyWALL then blocks or forwards access to the web page depending on the configuration of the rest of this page.
Matched Web Pages	<p>Select Block to prevent users from accessing web pages that match the categories that you select below.</p> <p>When external database content filtering blocks access to a web page, it displays the denied access message that you configured in the Content Filtering General screen along with the category of the blocked web page.</p> <p>Select Log to record attempts to access prohibited web pages.</p>
Unrated Web Pages	<p>Select Block to prevent users from accessing web pages that the external database content filtering has not categorized.</p> <p>When the external database content filtering blocks access to a web page, it displays the denied access message that you configured in the Content Filtering General screen along with the category of the blocked web page.</p> <p>Select Log to record attempts to access web pages that are not categorized.</p>
When Content Filter Server Is Unavailable	<p>Select Block to block access to any requested web page if the external content filtering database is unavailable. The following are possible causes:</p> <p>There is no response from the external content filtering database within the time period specified in the Content Filter Server Unavailable Timeout field.</p> <p>The ZyWALL is not able to resolve the domain name of the external content filtering database.</p> <p>There is an error response from the external content filtering database (this can be caused by an expired content filtering registration).</p> <p>Select Log to record attempts to access web pages that occur when the external content filtering database is unavailable.</p>
Content Filter Server Unavailable Timeout	Specify a number of seconds (1 to 30) for the ZyWALL to wait for a response from the external content filtering server. If there is still no response by the time this period expires, the ZyWALL blocks or allows access to the requested web page based on the setting in the Block When Content Server Filter Is Unavailable field.
Select Categories	

Table 13-2 Content Filtering Categories

LABEL	DESCRIPTION
Select All Categories	Select this check box to restrict access to all site categories listed below.
Clear All Categories	Select this check box to clear the selected categories below.
Adult/Mature Content	Selecting this category excludes pages that contain material of adult nature that does not necessarily contain excessive violence, sexual content, or nudity. These pages include very profane or vulgar content and pages that are not appropriate for children.
Pornography	Selecting this category excludes pages that contain sexually explicit material for the purpose of arousing a sexual or prurient interest.
Sex Education	Selecting this category excludes pages that provide graphic information (sometimes graphic) on reproduction, sexual development, safe sex practices, sexuality, birth control, and sexual development. It also includes pages that offer tips for better sex as well as products used for sexual enhancement.
Intimate Apparel/Swimsuit	Selecting this category excludes pages that contain images or offer the sale of swimsuits or intimate apparel or other types of suggestive clothing. It does not include pages selling undergarments as a subsection of other products offered.
Nudity	Selecting this category excludes pages containing nude or seminude depictions of the human body. These depictions are not necessarily sexual in intent or effect, but may include pages containing nude paintings or photo galleries of artistic nature. This category also includes nudist or naturist pages that contain pictures of nude individuals.
Alcohol/Tobacco	Selecting this category excludes pages that promote or offer the sale alcohol/tobacco products, or provide the means to create them. It also includes pages that glorify, tout, or otherwise encourage the consumption of alcohol/tobacco. It does not include pages that sell alcohol or tobacco as a subset of other products.
Illegal/Questionable	Selecting this category excludes pages that advocate or give advice on performing illegal acts such as service theft, evading law enforcement, fraud, burglary techniques and plagiarism. It also includes pages that provide or sell questionable educational materials, such as term papers.
Gambling	Selecting this category excludes pages where a user can place a bet or participate in a betting pool (including lotteries) online. It also includes pages that provide information, assistance, recommendations, or training on placing bets or participating in games of chance. It does not include pages that sell gambling related products or machines. It also does not include pages for offline casinos and hotels (as long as those pages do not meet one of the above requirements).

Table 13-2 Content Filtering Categories

LABEL	DESCRIPTION
Violence/Hate/Racism	Selecting this category excludes pages that depict extreme physical harm to people or property, or that advocate or provide instructions on how to cause such harm. It also includes pages that advocate, depict hostility or aggression toward, or denigrate an individual or group on the basis of race, religion, gender, nationality, ethnic origin, or other characteristics.
Weapons	Selecting this category excludes pages that sell, review, or describe weapons such as guns, knives or martial arts devices, or provide information on their use, accessories, or other modifications. It does not include pages that promote collecting weapons, or groups that either support or oppose weapons use.
Abortion	Selecting this category excludes pages that provide information or arguments in favor of or against abortion, describe abortion procedures, offer help in obtaining or avoiding abortion, or provide information on the effects, or lack thereof, of abortion.
Arts/Entertainment	Selecting this category excludes pages that promote and provide information about motion pictures, videos, television, music and programming guides, books, comics, movie theatres, galleries, artists or reviews on entertainment.
Business/Economy	Selecting this category excludes pages devoted to business firms, business information, economics, marketing, business management and entrepreneurship. This does not include pages that perform services that are defined in another category (such as Information Technology companies, or companies that sell travel services).
Cult/Occult	Selecting this category excludes pages that promote or offer methods, means of instruction, or other resources to affect or influence real events through the use of spells, curses, magic powers and satanic or supernatural beings.
Illegal Drugs	Selecting this category excludes pages that promote, offer, sell, supply, encourage or otherwise advocate the illegal use, cultivation, manufacture, or distribution of drugs, pharmaceuticals, intoxicating plants or chemicals and their related paraphernalia.
Education	Selecting this category excludes pages that offer educational information, distance learning and trade school information or programs. It also includes pages that are sponsored by schools, educational facilities, faculty, or alumni groups.
Cultural Institutions	Selecting this category excludes pages sponsored by cultural institutions, or those that provide information about museums, galleries, and theaters (not movie theaters). It includes groups such as 4H and the Boy Scouts of America.

Table 13-2 Content Filtering Categories

LABEL	DESCRIPTION
Financial Services	Selecting this category excludes pages that provide or advertise banking services (online or offline) or other types of financial information, such as loans. It does not include pages that offer market information, brokerage or trading services.
Brokerage/Trading	Selecting this category excludes pages that provide or advertise trading of securities and management of investment assets (online or offline). It also includes insurance pages, as well as pages that offer financial investment strategies, quotes, and news.
Games	Selecting this category excludes pages that provide information and support game playing or downloading, video games, computer games, electronic games, tips, and advice on games or how to obtain cheat codes. It also includes pages dedicated to selling board games as well as journals and magazines dedicated to game playing. It includes pages that support or host online sweepstakes and giveaways.
Government/Legal	Selecting this category excludes pages sponsored by or which provide information on government, government agencies and government services such as taxation and emergency services. It also includes pages that discuss or explain laws of various governmental entities.
Military	Selecting this category excludes pages that promote or provide information on military branches or armed services.
Political/Activist Groups	Selecting this category excludes pages sponsored by or which provide information on political parties, special interest groups, or any organization that promotes change or reform in public policy, public opinion, social practice, or economic activities.
Health	Selecting this category excludes pages that provide advice and information on general health such as fitness and well-being, personal health or medical services, drugs, alternative and complimentary therapies, medical information about ailments, dentistry, optometry, general psychiatry, self-help, and support organizations dedicated to a disease or condition.
Computers/Internet	Selecting this category excludes pages that sponsor or provide information on computers, technology, the Internet and technology-related organizations and companies.
Hacking/Proxy Avoidance	Pages providing information on illegal or questionable access to or the use of communications equipment/software, or provide information on how to bypass proxy server features or gain access to URLs in any way that bypasses the proxy server.

Table 13-2 Content Filtering Categories

LABEL	DESCRIPTION
Search Engines/Portals	Selecting this category excludes pages that support searching the Internet, indices, and directories.
Web Communications	Selecting this category excludes pages that allow or offer Web-based communication via e-mail, chat, instant messaging, message boards, etc.
Job Search/Careers	Selecting this category excludes pages that provide assistance in finding employment, and tools for locating prospective employers.
News/Media	Selecting this category excludes pages that primarily report information or comments on current events or contemporary issues of the day. It also includes radio stations and magazines. It does not include pages that can be rated in other categories.
Personals/Dating	Selecting this category excludes pages that promote interpersonal relationships.
Reference	Selecting this category excludes pages containing personal, professional, or educational reference, including online dictionaries, maps, census, almanacs, library catalogues, genealogy-related pages and scientific information.
Chat/Instant Messaging	Selecting this category excludes pages that provide chat or instant messaging capabilities or client downloads.
Email	Selecting this category excludes pages offering web-based email services, such as online email reading, e-cards, and mailing list services.
Newsgroups	Selecting this category excludes pages that offer access to Usenet news groups or other messaging or bulletin board systems.
Religion	Selecting this category excludes pages that promote and provide information on conventional or unconventional religious or quasi-religious subjects, as well as churches, synagogues, or other houses of worship. It does not include pages containing alternative religions such as Wicca or witchcraft (Cult/Occult) or atheist beliefs (Political/Activist Groups).
Shopping	Selecting this category excludes pages that provide or advertise the means to obtain goods or services. It does not include pages that can be classified in other categories (such as vehicles or weapons).
Auctions	Selecting this category excludes pages that support the offering and purchasing of goods between individuals. This does not include classified advertisements.
Real Estate	Selecting this category excludes pages that provide information on renting, buying, or selling real estate or properties.

Table 13-2 Content Filtering Categories

LABEL	DESCRIPTION
Society/Lifestyle	Selecting this category excludes pages providing information on matters of daily life. This does not include pages relating to entertainment, sports, jobs, sex or pages promoting alternative lifestyles such as homosexuality. Personal homepages fall within this category if they cannot be classified in another category.
Gay/Lesbian	Selecting this category excludes pages that provide information, promote, or cater to gay and lesbian lifestyles. This does not include pages that are sexually oriented.
Restaurants/Dining/Food	Selecting this category excludes pages that list, review, discuss, advertise and promote food, catering, dining services, cooking and recipes.
Sports/Recreation/Hobbies	Selecting this category excludes pages that promote or provide information about spectator sports, recreational activities, or hobbies. This includes pages that discuss or promote camping, gardening, and collecting.
Travel	Selecting this category excludes pages that promote or provide opportunity for travel planning, including finding and making travel reservations, vehicle rentals, descriptions of travel destinations, or promotions for hotels or casinos.
Vehicles	Selecting this category excludes pages that provide information on or promote vehicles, boats, or aircraft, including pages that support online purchase of vehicles or parts.
Humor/Jokes	Selecting this category excludes pages that primarily focus on comedy, jokes, fun, etc. This may include pages containing jokes of adult or mature nature. Pages containing humorous Adult/Mature content also have an Adult/Mature category rating.
Streaming Media/MP3	Selecting this category excludes pages that sell, deliver, or stream music or video content in any format, including pages that provide downloads for such viewers.
Software Downloads	Selecting this category excludes pages that are dedicated to the electronic download of software packages, whether for payment or at no charge.
Pay to Surf	Selecting this category excludes pages that pay users in the form of cash or prizes, for clicking on or reading specific links, email, or web pages.
For Kids	Selecting this category excludes pages designed specifically for children.
Web Advertisements	Selecting this category excludes pages that provide online advertisements or banners. This does not include advertising servers that serve adult-oriented advertisements.

Table 13-2 Content Filtering Categories

LABEL	DESCRIPTION
Web Hosting	Selecting this category excludes pages of organizations that provide top-level domain pages, as well as web communities or hosting services.
Advanced/Basic	Click Advanced to see an expanded list of categories, or click Basic to see a smaller list.
Test Web Site Attribute	
Test if Web site is blocked	You can check whether or not the content filter currently blocks any given web page. Enter a web page address in the text box.
Test Against Local Cache	Click this button to test whether or not the web page above is saved in the ZyWALL's database of restricted web pages.
Test Against Internet Server	Click this button to test whether or not the web page above is saved in the external content filter server's database of restricted web pages.
Registration and Reports	
Registration Status	<p>This read-only field displays Registered if you have successfully registered the ZyWALL for category-based content filtering (using an external database).</p> <p>This field displays Unregistered if you have not successfully registered the ZyWALL or your registration has expired.</p> <hr/> <p style="text-align: center;">This field only displays whether or not you have successfully registered, not whether or not content filtering is active. See <i>section 13.5</i> for how to check the content filtering activation.</p> <hr/>

Table 13-2 Content Filtering Categories

LABEL	DESCRIPTION
Register	<p>Click Register to go to a web site where you can register for category-based content filtering (using an external database). You can use a trial application or register your iCard's PIN. Refer to the web site's on-line help for details.</p> <hr/> <p style="text-align: center;">The web site displays a registration successful web page. It may take up to another ten minutes for content filtering to be activated. See <i>section 13.5</i> for how to check the content filtering activation.</p> <hr/> <p>You can manage your registration status or view content filtering reports after you register this device.</p> <p>You cannot access the web site if you have enabled content filtering in the Content Filtering General screen and blocked access to web pages that use Java.</p>
Apply	Click Apply to save your changes back to the ZyWALL.
Reset	Click Reset to begin configuring this screen afresh.

13.7 Configuring Customization

To customize the content filter list by adding or removing specific sites from the filter list on your ZyWALL, click **CONTENT FILTER**, then the **Customization** tab. The screen appears as shown.

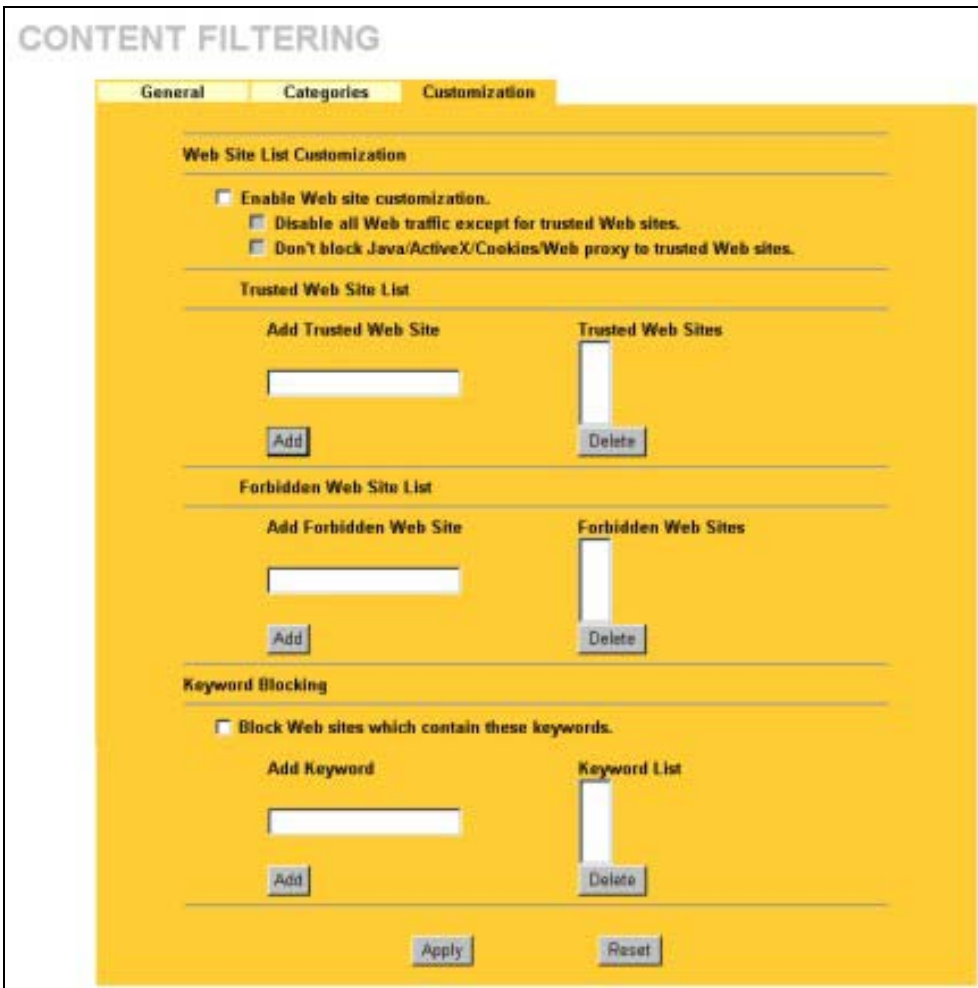

Figure 13-4 Content Filtering Customization

The following table describes the labels in this screen.

Table 13-3 Content Filtering Customization

LABEL	DESCRIPTION
WEB Site List Customization	

Table 13-3 Content Filtering Customization

LABEL	DESCRIPTION
Enable WEB site customization	Select this check box to allow Trusted Domain web sites and block Forbidden Domain web sites. Content filter list customization may be enabled and disabled without re-entering the site names.
Disable all web traffic except for trusted Web sites	When this box is selected, the ZyWALL only allows Web access to sites on the Trusted Web Site list. If they are chosen carefully, this is the most effective way to block objectionable material.
Don't block Java/ActiveX/Cookies/Web proxy to trusted Web sites	When this box is selected, the ZyWALL will permit Java, ActiveX and Cookies from sites on the Trusted Web Site list to the LAN. In certain cases, it may be desirable to allow Java, ActiveX or Cookies from sites that are known and trusted.
Trusted Web Site List	These are sites that you want to allow access to, regardless of their content rating, can be allowed by adding them to this list. You can enter up to 32 entries.
Add Trusted Web Site	Enter host names such as "www.good-site.com" into this text field. Do not enter the complete URL of the site – that is, do not include "http://". All sub domains are allowed. For example, entering "zyxel.com" also allows "www.zyxel.com", "partner.zyxel.com", "press.zyxel.com", etc.
Trusted Web Sites	This list displays the trusted web sites already added.
Add	Click this button when you have finished adding the host name in the text field above.
Delete	Select a web site name from the Trusted Web Site List , and then click this button to delete it from that list.
Forbidden Web Site List	Sites that you want to block access to, regardless of their content rating, can be allowed by adding them to this list. You can enter up to 32 entries.
Add Forbidden Web Site	Enter host names such as "www.bad-site.com" into this text field. Do not enter the complete URL of the site – that is, do not include "http://". All sub domains are allowed. For example, entering "bad-site.com" also blocks "www.bad-site.com", "partner.bad-site.com", "press.bad-site.com", etc.
Forbidden Web Sites	This list displays the forbidden web sites already added.
Add	Click this button when you have finished adding the host name in the text field above.
Delete	Select a web site name from the Forbidden Web Site List , and then click this button to delete it from that list.

Table 13-3 Content Filtering Customization

LABEL	DESCRIPTION
Keyword Blocking	Keyword Blocking allows you to block websites that contain certain keywords.
Block Web sites which contain these keywords	Select this checkbox to enable keyword blocking.
Add Keyword	Enter a keyword to block.
Keyword List	This list displays the keywords already added.
Add	Click this button when you have finished adding the key words field above.
Delete	Select a keyword from the Keyword List , and then click this button to delete it from that list.
Apply	Click Apply to save your changes back to the ZyWALL.
Reset	Click Reset to begin configuring this screen afresh.

Part VI:

VPN/IPSec

This part provides information on how to configure Virtual Private Networks.

Chapter 14

Introduction to IPSec

This chapter introduces the basics of IPSec VPNs.

14.1 VPN Overview

A VPN (Virtual Private Network) provides secure communications between sites without the expense of leased site-to-site lines. A secure VPN is a combination of tunneling, encryption, authentication, access control and auditing technologies/services used to transport traffic over the Internet or any insecure network that uses the TCP/IP protocol suite for communication.

14.1.1 IPSec

Internet Protocol Security (IPSec) is a standards-based VPN that offers flexible solutions for secure data communications across a public network like the Internet. IPSec is built around a number of standardized cryptographic techniques to provide confidentiality, data integrity and authentication at the IP layer.

14.1.2 Security Association

A Security Association (SA) is a contract between two parties indicating what security parameters, such as keys and algorithms they will use.

14.1.3 Other Terminology

➤ Encryption

Encryption is a mathematical operation that transforms data from "plaintext" (readable) to "ciphertext" (scrambled text) using a "key". The key and clear text are processed by the encryption operation, which leads to the data scrambling that makes encryption secure. Decryption is the opposite of encryption: it is a mathematical operation that transforms "ciphertext" to plaintext. Decryption also requires a key.

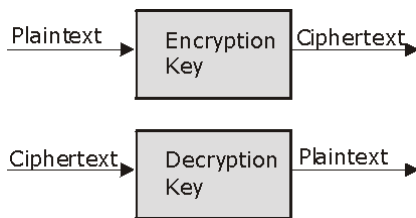

Figure 14-1 Encryption and Decryption

➤ **Data Confidentiality**

The IPSec sender can encrypt packets before transmitting them across a network.

➤ **Data Integrity**

The IPSec receiver can validate packets sent by the IPSec sender to ensure that the data has not been altered during transmission.

➤ **Data Origin Authentication**

The IPSec receiver can verify the source of IPSec packets. This service depends on the data integrity service.

14.1.4 VPN Applications

The ZyWALL supports the following VPN applications.

➤ **Linking Two or More Private Networks Together**

Connect branch offices and business partners over the Internet with significant cost savings and improved performance when compared to leased lines between sites.

➤ **Accessing Network Resources When NAT Is Enabled**

When NAT is enabled, remote users are not able to access hosts on the LAN unless the host is designated a public LAN server for that specific protocol. Since the VPN tunnel terminates inside the LAN, remote users will be able to access all computers that use private IP addresses on the LAN.

➤ **Unsupported IP Applications**

A VPN tunnel may be created to add support for unsupported emerging IP applications.

14.2 IPSec Architecture

The overall IPSec architecture is shown as follows.

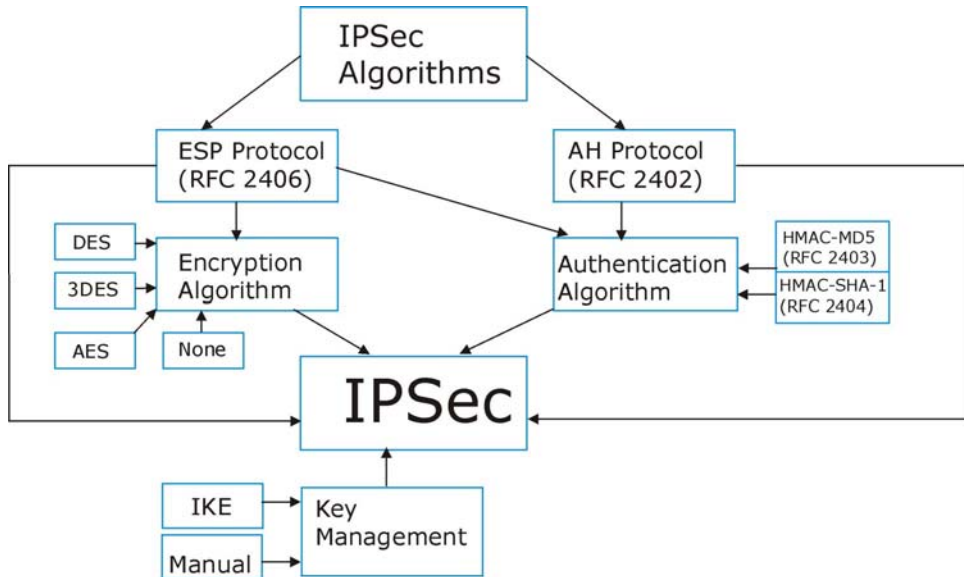

Figure 14-2 IPsec Architecture

14.2.1 IPsec Algorithms

The **ESP** (Encapsulating Security Payload) Protocol (RFC 2406) and **AH** (Authentication Header) protocol (RFC 2402) describe the packet formats and the default standards for packet structure (including implementation algorithms).

The Encryption Algorithm describes the use of encryption techniques such as DES (Data Encryption Standard), AES (Advanced Encryption Standard) and Triple DES algorithms.

The Authentication Algorithms, HMAC-MD5 (RFC 2403) and HMAC-SHA-1 (RFC 2404), provide an authentication mechanism for the **AH** and **ESP** protocols. Please see *section 15.2* for more information.

14.2.2 Key Management

Key management allows you to determine whether to use IKE (ISAKMP) or manual key configuration in order to set up a VPN.

14.3 Encapsulation

The two modes of operation for IPsec VPNs are **Transport** mode and **Tunnel** mode.

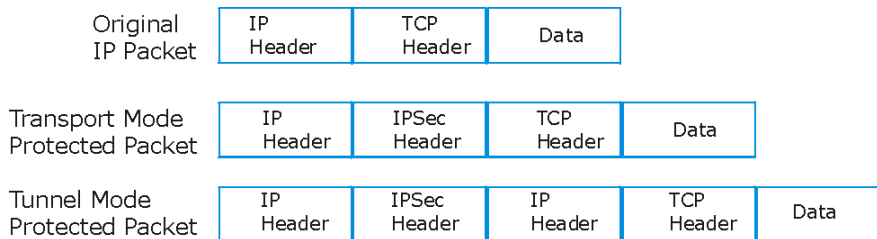

Figure 14-3 Transport and Tunnel Mode IPsec Encapsulation

14.3.1 Transport Mode

Transport mode is used to protect upper layer protocols and only affects the data in the IP packet. In **Transport** mode, the IP packet contains the security protocol (**AH** or **ESP**) located after the original IP header and options, but before any upper layer protocols contained in the packet (such as TCP and UDP). With **ESP**, protection is applied only to the upper layer protocols contained in the packet. The IP header information and options are not used in the authentication process. Therefore, the originating IP address cannot be verified for integrity against the data.

With the use of **AH** as the security protocol, protection is extended forward into the IP header to verify the integrity of the entire packet by use of portions of the original IP header in the hashing process.

14.3.2 Tunnel Mode

Tunnel mode encapsulates the entire IP packet to transmit it securely. A **Tunnel** mode is required for gateway services to provide access to internal systems. **Tunnel** mode is fundamentally an IP tunnel with authentication and encryption. This is the most common mode of operation. **Tunnel** mode is required for gateway to gateway and host to gateway communications. **Tunnel** mode communications have two sets of IP headers:

- **Outside header:** The outside IP header contains the destination IP address of the VPN gateway.
- **Inside header:** The inside IP header contains the destination IP address of the final system behind the VPN gateway. The security protocol appears after the outer IP header and before the inside IP header.

14.4 IPsec and NAT

Read this section if you are running IPsec on a host computer behind the ZyWALL.

NAT is incompatible with the **AH** protocol in both **Transport** and **Tunnel** mode. An IPsec VPN using the **AH** protocol digitally signs the outbound packet, both data payload and headers, with a hash value appended to the packet. When using **AH** protocol, packet contents (the data payload) are not encrypted.

A NAT device in between the IPsec endpoints will rewrite either the source or destination address with one of its own choosing. The VPN device at the receiving end will verify the integrity of the incoming packet by computing its own hash value, and complain that the hash value appended to the received packet doesn't

match. The VPN device at the receiving end doesn't know about the NAT in the middle, so it assumes that the data has been maliciously altered.

IPSec using **ESP** in **Tunnel** mode encapsulates the entire original packet (including headers) in a new IP packet. The new IP packet's source address is the outbound address of the sending VPN gateway, and its destination address is the inbound address of the VPN device at the receiving end. When using **ESP** protocol with authentication, the packet contents (in this case, the entire original packet) are encrypted. The encrypted contents, but not the new headers, are signed with a hash value appended to the packet.

Tunnel mode **ESP** with authentication is compatible with NAT because integrity checks are performed over the combination of the "original header plus original payload," which is unchanged by a NAT device.

Transport mode **ESP** with authentication is not compatible with NAT, although NAT traversal provides a way to use **Transport** mode **ESP** when there is a NAT router between the IPSec endpoints (see *section 15.7* for details).

Table 14-1 VPN and NAT

SECURITY PROTOCOL	MODE	NAT
AH	Transport	N
AH	Tunnel	N
ESP	Transport	N
ESP	Tunnel	Y

Chapter 15

VPN Screens

This chapter introduces the VPN Web Configurator. See the Logs chapter for information on viewing logs and the Appendices for IPSec log descriptions.

15.1 VPN/IPSec Overview

Use the screens documented in this chapter to configure rules for VPN connections and manage VPN connections.

15.2 IPSec Algorithms

The **ESP** and **AH** protocols are necessary to create a Security Association (SA), the foundation of an IPSec VPN. An SA is built from the authentication provided by the **AH** and **ESP** protocols. The primary function of key management is to establish and maintain the SA between systems. Once the SA is established, the transport of data may commence.

15.2.1 AH (Authentication Header) Protocol

AH protocol (RFC 2402) was designed for integrity, authentication, sequence integrity (replay resistance), and non-repudiation but not for confidentiality, for which the **ESP** was designed.

In applications where confidentiality is not required or not sanctioned by government encryption restrictions, an **AH** can be employed to ensure integrity. This type of implementation does not protect the information from dissemination but will allow for verification of the integrity of the information and authentication of the originator.

15.2.2 ESP (Encapsulating Security Payload) Protocol

The **ESP** protocol (RFC 2406) provides encryption as well as some of the services offered by **AH**. **ESP** authenticating properties are limited compared to the **AH** due to the non-inclusion of the IP header information during the authentication process. However, **ESP** is sufficient if only the upper layer protocols need to be authenticated.

An added feature of the **ESP** is payload padding, which further protects communications by concealing the size of the packet being transmitted.

Table 15-1 AH and ESP

ESP	AH
DES (default) Data Encryption Standard (DES) is a widely used method of data encryption using a secret key. DES applies a 56-bit key to each 64-bit block of data.	MD5 (default) MD5 (Message Digest 5) produces a 128-bit digest to authenticate packet data.
3DES Triple DES (3DES) is a variant of DES, which iterates three times with three separate keys (3 x 56 = 168 bits), effectively doubling the strength of DES.	SHA1 SHA1 (Secure Hash Algorithm) produces a 160-bit digest to authenticate packet data.
AES Advanced Encryption Standard is a newer method of data encryption that also uses a secret key. This implementation of AES applies a 128-bit key to 128-bit blocks of data. AES is faster than 3DES.	
Select DES for minimal security and 3DES or AES for maximum. Select NULL to set up a tunnel without encryption.	Select MD5 for minimal security and SHA-1 for maximum security.

15.3 My IP Address

My IP Address is the WAN IP address of the ZyWALL. The ZyWALL has to rebuild the VPN tunnel if the **My IP Address** changes after setup.

The following applies if this field is configured as **0.0.0.0**:

- The ZyWALL uses the current ZyWALL WAN IP address (static or dynamic) to set up the VPN tunnel.
- If the WAN connection goes down, the ZyWALL uses the dial backup IP address for the VPN tunnel when using dial backup or the LAN IP address when using traffic redirect. See the chapter on WAN for details on dial backup and traffic redirect.

15.4 Secure Gateway Address

Secure Gateway Address is the WAN IP address or domain name of the remote IPSec router (secure gateway).

If the remote secure gateway has a static WAN IP address, enter it in the **Secure Gateway Address** field. You may alternatively enter the remote secure gateway's domain name (if it has one) in the **Secure Gateway Address** field.

You can also enter a remote secure gateway's domain name in the **Secure Gateway Address** field if the remote secure gateway has a dynamic WAN IP address and is using DDNS. The ZyWALL has to rebuild the VPN tunnel each time the remote secure gateway's WAN IP address changes (there may be a delay until the DDNS servers are updated with the remote gateway's new WAN IP address).

15.4.1 Dynamic Secure Gateway Address

If the remote secure gateway has a dynamic WAN IP address and does not use DDNS, enter 0.0.0.0 as the secure gateway's address. In this case only the remote secure gateway can initiate SAs. This may be useful for telecommuters initiating a VPN tunnel to the company network. See *section 15.18* for configuration examples.

The Secure Gateway IP Address may be configured as 0.0.0.0 only when using IKE key management and not Manual key management.

15.5 VPN Rules Screen

The following figure helps explain the main fields in the web configurator.

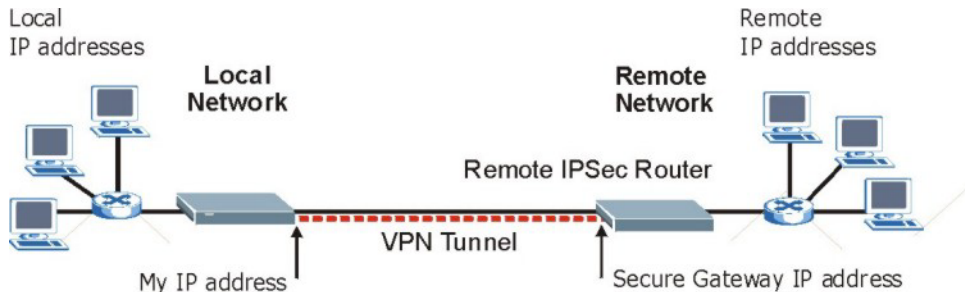

Figure 15-1 IPsec VPN Rules Fields

Local and remote IP addresses must be static.

Click **VPN Rules** to open the **VPN Rules** screen. This is a read-only summary of your IPsec rules (tunnels). Edit or create an IPsec rule by selecting an index number and then clicking **Edit** to configure the associated submenus.

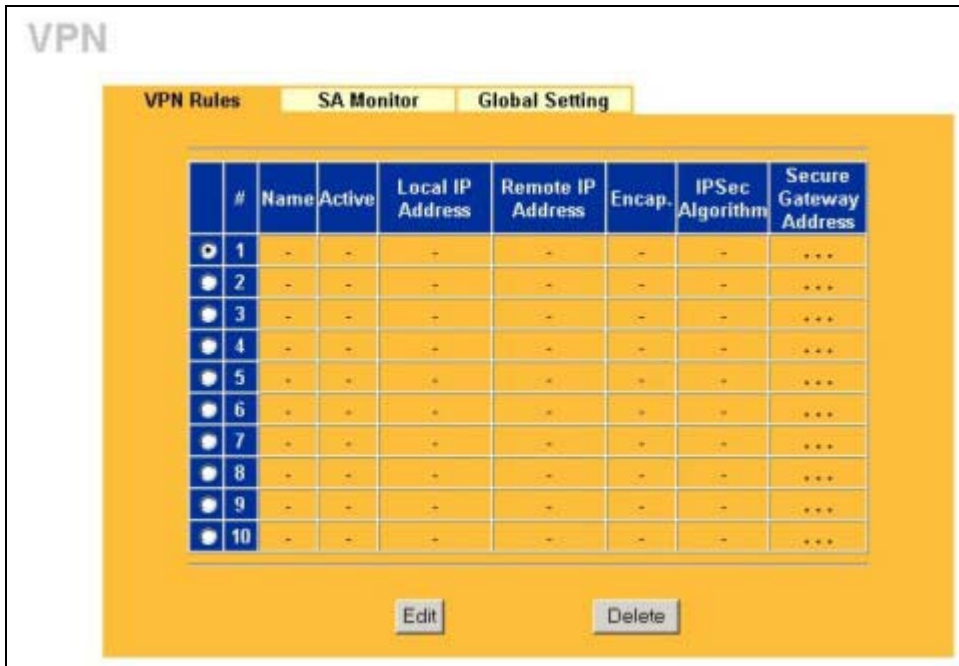

Figure 15-2 VPN Rules

The following table describes the labels in this screen.

Table 15-2 VPN Rules

LABEL	DESCRIPTION
#	The VPN policy index number
Name	This field displays the identification name for this VPN policy.
Active	This field displays whether the VPN policy is active or not. A Yes signifies that this VPN policy is active. No signifies that this VPN policy is not active.

Table 15-2 VPN Rules

LABEL	DESCRIPTION
Local Address	<p>This is the IP address(es) of computer(s) on your local network behind your ZyWALL.</p> <p>The same (static) IP address is displayed twice when the Local Address Type field in the Configure-IKE (or Manual) screen is configured to Single Address.</p> <p>The beginning and ending (static) IP addresses, in a range of computers are displayed when the Local Address Type field in the Configure-IKE (or Manual) screen is configured to Range Address.</p> <p>A (static) IP address and a subnet mask are displayed when the Local Address Type field in the Configure-IKE (or Manual) screen is configured to Subnet Address.</p>
Remote Address	<p>This is the IP address(es) of computer(s) on the remote network behind the remote IPsec router.</p> <p>This field displays N/A when the Secure Gateway Addr field displays 0.0.0.0. In this case only the remote IPsec router can initiate the VPN.</p> <p>The same (static) IP address is displayed twice when the Remote Address Type field in the Configure-IKE (or Manual) screen is configured to Single Address.</p> <p>The beginning and ending (static) IP addresses, in a range of computers are displayed when the Remote Address Type field in the Configure-IKE (or Manual) screen is configured to Range Address.</p> <p>A (static) IP address and a subnet mask are displayed when the Remote Address Type field in the Configure-IKE (or Manual) screen is configured to Subnet Address.</p>
Encap	This field displays Tunnel or Transport mode (Tunnel is the default selection).
IPsec Algorithm	<p>This field displays the security protocols used for an SA.</p> <p>Both AH and ESP increase ZyWALL processing requirements and communications latency (delay).</p>
Secure Gateway Addr	This is the static WAN IP address or URL of the remote IPsec router. This field displays 0.0.0.0 when you configure the Secure Gateway Addr field in the Configure-IKE screen to 0.0.0.0 .
<p>Select the radio button next to a VPN index number and then click Edit to edit a specific VPN policy. Click the radio button next to an empty VPN policy index number and then Edit to add a new VPN policy.</p> <p>Select the radio button next to a VPN policy number you want to delete and then click Delete. When a VPN policy is deleted, subsequent policies do not move up in the page list.</p>	

15.6 Keep Alive

When you initiate an IPSec tunnel with keep alive enabled, the ZyWALL automatically renegotiates the tunnel when the IPSec SA lifetime period expires (see *section 15.12* for more on the IPSec SA lifetime). In effect, the IPSec tunnel becomes an “always on” connection after you initiate it. Both IPSec routers must have a ZyWALL-compatible keep alive feature enabled in order for this feature to work.

If the ZyWALL has its maximum number of simultaneous IPSec tunnels connected to it and they all have keep alive enabled, then no other tunnels can take a turn connecting to the ZyWALL because the ZyWALL never drops the tunnels that are already connected. Check *Table 1-1 Model Specific Features* in chapter 1 to see how many simultaneous IPSec SAs your ZyWALL model can support.

When there is outbound traffic with no inbound traffic, the ZyWALL automatically drops the tunnel after two minutes.

15.7 NAT Traversal

NAT traversal allows you to set up a VPN connection when there are NAT routers between IPSec routers A and B.

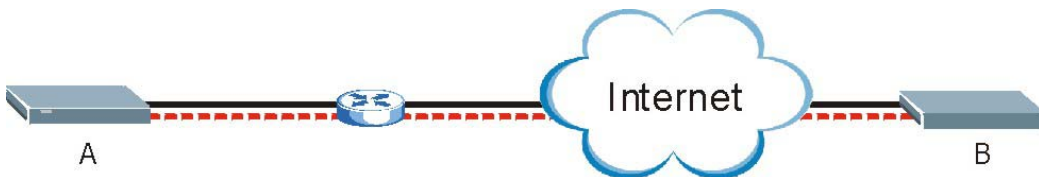

Figure 15-3 NAT Router Between IPSec Routers

Normally you cannot set up a VPN connection with a NAT router between the two IPSec routers because the NAT router changes the header of the IPSec packet. In the previous figure, IPSec router A sends an IPSec packet in an attempt to initiate a VPN. The NAT router changes the IPSec packet’s header so it does not match the header for which IPSec router B is checking. Therefore, IPSec router B does not respond and the VPN connection cannot be built.

NAT traversal solves the problem by adding a UDP port 500 header to the IPSec packet. The NAT router forwards the IPSec packet with the UDP port 500 header unchanged. IPSec router B checks the UDP port 500 header and responds. IPSec routers A and B build a VPN connection.

15.7.1 NAT Traversal Configuration

For NAT traversal to work you must:

- Use ESP security protocol (in either transport or tunnel mode).

- Use IKE keying mode.
- Enable NAT traversal on both IPSec endpoints.

In order for IPSec router A (see the figure) to receive an initiating IPSec packet from IPSec router B, set the NAT router to forward UDP port 500 to IPSec router A.

15.7.2 X-Auth (Extended Authentication)

Extended authentication provides added security by allowing you to use usernames and passwords for VPN connections. This is especially helpful when multiple ZyWALLs use one VPN rule to connect to a single ZyWALL. An attacker cannot make a VPN connection without a valid username and password.

The extended authentication server checks the user names and passwords of the extended authentication clients before completing the IPSec connection (see also the *Authentication Server* part).

A ZyWALL can be an extended authentication server for some VPN connections and an extended authentication client for other VPN connections.

15.7.3 DNS Server for IPSec VPN

In cases where you want to use domain names to access Intranet servers on a remote network that has a DNS server, you must identify that DNS server. You cannot use DNS servers on the LAN or from the ISP since these DNS servers cannot resolve domain names to private IP addresses on the remote network.

The following figure depicts an example where three VPN tunnels are created from ZyWALL A; one to branch office 2, one to branch office 3 and another to headquarters. In order to access computers that use private domain names on the headquarters (HQ) network, the ZyWALL at branch office 1 uses the Intranet DNS server in headquarters. The DNS server feature for VPN does not work with Windows 2000 or Windows XP.

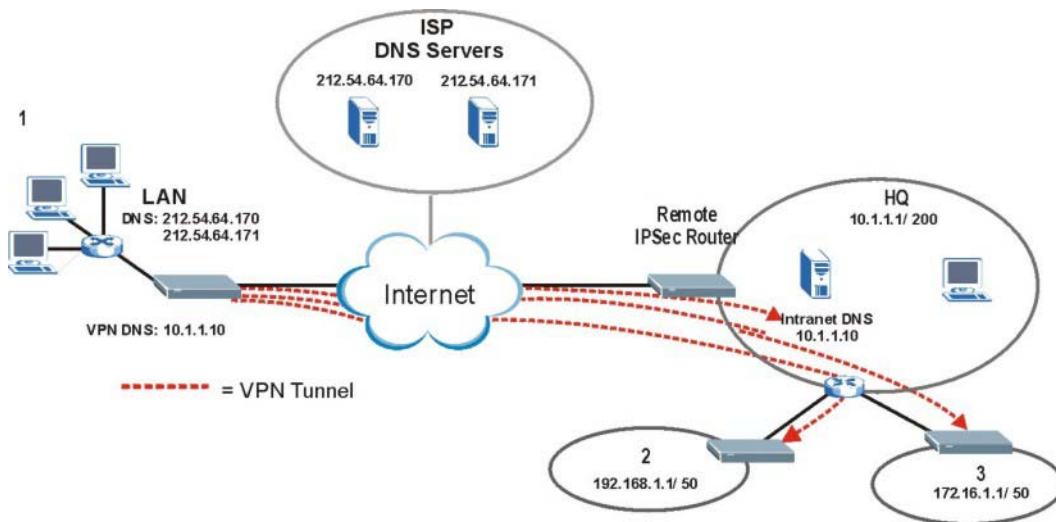

Figure 15-4 VPN Host using Intranet DNS Server Example

If you do not specify an Intranet DNS server on the remote network, then the VPN host must use IP addresses to access the computers on the remote network.

15.8 ID Type and Content

With aggressive negotiation mode (see *section 15.12.2*), the ZyWALL identifies incoming SAs by ID type and content since this identifying information is not encrypted. This enables the ZyWALL to distinguish between multiple rules for SAs that connect from remote IPSec routers that have dynamic WAN IP addresses. Telecommuters can use separate passwords to simultaneously connect to the ZyWALL from IPSec routers with dynamic IP addresses (see *section 15.18.2* for a telecommuter configuration example).

Regardless of the ID type and content configuration, the ZyWALL does not allow you to save multiple active rules with overlapping local and remote IP addresses.

With main mode (see *section 15.12.2*), the ID type and content are encrypted to provide identity protection. In this case the ZyWALL can only distinguish between up to 12 different incoming SAs that connect from remote IPSec routers that have dynamic WAN IP addresses. The ZyWALL can distinguish up to 12 incoming SAs because you can select between three encryption algorithms (DES, 3DES and AES), two authentication algorithms (MD5 and SHA1) and two key groups (DH1 and DH2) when you configure a VPN rule (see *section 15.13*). The ID type and content act as an extra level of identification for incoming SAs.

The type of ID can be a domain name, an IP address or an e-mail address. The content is the IP address, domain name, or e-mail address.

Table 15-3 Local ID Type and Content Fields

LOCAL ID TYPE	CONTENT
IP	Type the IP address of your computer or leave the field blank to have the ZyWALL automatically use its own IP address.
DNS	Type a domain name (up to 31 characters) by which to identify this ZyWALL.
E-mail	Type an e-mail address (up to 31 characters) by which to identify this ZyWALL.
The domain name or e-mail address that you use in the Content field is used for identification purposes only and does not need to be a real domain name or e-mail address.	

Table 15-4 Peer ID Type and Content Fields

PEER ID TYPE	CONTENT
IP	Type the IP address of the computer with which you will make the VPN connection or leave the field blank to have the ZyWALL automatically use the address in the Secure Gateway field.
DNS	Type a domain name (up to 31 characters) by which to identify the remote IPSec router.
E-mail	Type an e-mail address (up to 31 characters) by which to identify the remote IPSec router.
The domain name or e-mail address that you use in the Content field is used for identification purposes only and does not need to be a real domain name or e-mail address. The domain name also does not have to match the remote router's IP address or what you configure in the Secure Gateway Addr field below.	

15.8.1 ID Type and Content Examples

Two IPSec routers must have matching ID type and content configuration in order to set up a VPN tunnel. The two ZyWALLs in this example can complete negotiation and establish a VPN tunnel.

Table 15-5 Matching ID Type and Content Configuration Example

ZYWALL A	ZYWALL B
Local ID type: E-mail	Local ID type: IP
Local ID content: tom@yourcompany.com	Local ID content: 1.1.1.2

Table 15-5 Matching ID Type and Content Configuration Example

ZYWALL A	ZYWALL B
Peer ID type: IP	Peer ID type: E-mail
Peer ID content: 1.1.1.2	Peer ID content: tom@yourcompany.com

The two ZyWALLs in this example cannot complete their negotiation because ZyWALL B's **Local ID type** is **IP**, but ZyWALL A's **Peer ID type** is set to **E-mail**. An "ID mismatched" message displays in the IPSEC LOG.

Table 15-6 Mismatching ID Type and Content Configuration Example

ZYWALL A	ZYWALL B
Local ID type: IP	Local ID type: IP
Local ID content: 1.1.1.10	Local ID content: 1.1.1.10
Peer ID type: E-mail	Peer ID type: IP
Peer ID content: aa@yahoo.com	Peer ID content: N/A

15.9 Pre-Shared Key

A pre-shared key identifies a communicating party during a phase 1 IKE negotiation (see *section 15.12* for more on IKE phases). It is called "pre-shared" because you have to share it with another party before you can communicate with them over a secure connection.

15.10 Certificates

The ZyWALL can use certificates to authenticate the devices attempting to form a VPN connection. See the *Certificates* part for more on certificates and public-private keys.

15.11 Editing VPN Policies

Click **Edit** in the **VPN Rules** screen to edit a VPN policy.

VPN - VPN RULE - EDIT

Active Keep alive NAT Traversal

Name
 Key Management
 Negotiation Mode

Enable Extended Authentication
 Server Mode (Search [Local User](#) first then [RADIUS](#))
 Client Mode
 User Name
 Password

Local
 Address Type
 Starting IP Address
 Ending IP Address / Subnet Mask

Remote
 Address Type
 Starting IP Address
 Ending IP Address / Subnet Mask

DNS Server (for IPsec VPN)

Authentication Method
 Pre-Shared Key
 Certificate
 Local ID Type
 Content
 Peer ID Type
 Content

My IP Address
Secure Gateway Address
 Encapsulation Mode

ESP AH
 Encryption Algorithm Authentication Algorithm
 Authentication Algorithm

Figure 15-5 VPN IKE

The following table describes the labels in this screen.

Table 15-7 VPN IKE

LABEL	DESCRIPTION
Active	Select this check box to activate this VPN tunnel. This option determines whether a VPN rule is applied before a packet leaves the firewall.
Keep Alive	Enable keep alive to have the ZyWALL automatically re-initiate the SA after the SA lifetime times out, even if there is no traffic. The remote IPSec router must also have keep alive enabled in order for this feature to work.
NAT Traversal	<p>Select this check box to enable NAT traversal. NAT traversal allows you to set up a VPN connection when there are NAT routers between the two IPSec routers.</p> <p>The remote IPSec router must also have NAT traversal enabled.</p> <p>You can use NAT traversal with ESP protocol using Transport or Tunnel mode, but not with AH protocol nor with manual key management. In order for an IPSec router behind a NAT router to receive an initiating IPSec packet, set the NAT router to forward UDP port 500 to the IPSec router behind the NAT router.</p>
Name	Type up to 32 characters to identify this VPN policy. You may use any character, including spaces, but the ZyWALL drops trailing spaces.
Key Management	Select IKE or Manual Key from the drop-down list box. IKE provides more protection so it is generally recommended. Manual Key is a useful option for troubleshooting.
Negotiation Mode	Select Main or Aggressive from the drop-down list box. Multiple SAs connecting through a secure gateway must have the same negotiation mode.
Enable Extended Authentication	Select this check box to activate extended authentication. Use extended authentication to limit which remote IPSec routers with certificates can use this VPN connection.
Server Mode	<p>Select Server Mode to have this ZyWALL authenticate extended authentication clients that request this VPN connection.</p> <p>You must also configure the extended authentication clients' usernames and passwords in the auth server's local user database or a RADIUS server (see the <i>Authentication Server</i> part).</p> <p>Click Local User to go to the Local User Database screen where you can view and/or edit the list of users and passwords. Click RADIUS to go to the RADIUS screen where you can configure the ZyWALL to check an external RADIUS server.</p> <p>During authentication, if the extended authentication server does not find the extended authentication clients' user name in its internal user database and an external RADIUS server has been enabled, it attempts to authenticate the client through the RADIUS server.</p>

Table 15-7 VPN IKE

LABEL	DESCRIPTION
Client Mode	Select Client Mode to have your ZyWALL use a username and password when initiating this VPN connection to the extended authentication server ZyWALL. Only a VPN extended authentication client can initiate this VPN connection.
User Name	Enter a user name for your ZyWALL to be authenticated by the external extended authentication server. The user name can be up to 31 case-sensitive ASCII characters, but spaces are not allowed. You must enter a user name and password when you select client mode.
Password	Enter the corresponding password for the above user name. The password can be up to 31 case-sensitive ASCII characters, but spaces are not allowed.
Local	<p>Local IP addresses must be static and correspond to the remote IPSec router's configured remote IP addresses.</p> <p>Two active SAs can have the same configured local or remote IP address, but not both. You can configure multiple SAs between the same local and remote IP addresses, as long as only one is active at any time.</p> <p>In order to have more than one active rule with the Secure Gateway Address field set to 0.0.0.0, the ranges of the local IP addresses cannot overlap between rules.</p> <p>If you configure an active rule with 0.0.0.0 in the Secure Gateway Address field and the LAN's full IP address range as the local IP address, then you cannot configure any other active rules with the Secure Gateway Addr field set to 0.0.0.0.</p>
Address Type	Use the drop-down menu to choose Single Address , Range Address , or Subnet Address . Select Single Address for a single IP address. Select Range Address for a specific range of IP addresses. Select Subnet Address to specify IP addresses on a network by their subnet mask.
Starting IP Address	When the Address Type field is configured to Single Address , enter a (static) IP address on the LAN behind your ZyWALL. When the Address Type field is configured to Range Address , enter the beginning (static) IP address, in a range of computers on your LAN behind your ZyWALL. When the Address Type field is configured to Subnet Address , this is a (static) IP address on the LAN behind your ZyWALL.
Ending IP Address / Subnet Mask	When the Address Type field is configured to Single Address , this field is N/A. When the Address Type field is configured to Range Address , enter the end (static) IP address, in a range of computers on the LAN behind your ZyWALL. When the Address Type field is configured to Subnet Address , this is a subnet mask on the LAN behind your ZyWALL.

Table 15-7 VPN IKE

LABEL	DESCRIPTION
Remote	<p>Remote IP addresses must be static and correspond to the remote IPSec router's configured local IP addresses. The remote fields do not apply when the Secure Gateway Address field is configured to 0.0.0.0. In this case only the remote IPSec router can initiate the VPN.</p> <p>Two active SAs can have the same configured local or remote IP address, but not both. You can configure multiple SAs between the same local and remote IP addresses, as long as only one is active at any time.</p>
Address Type	<p>Use the drop-down menu to choose Single Address, Range Address, or Subnet Address. Select Single Address with a single IP address. Select Range Address for a specific range of IP addresses. Select Subnet Address to specify IP addresses on a network by their subnet mask.</p>
Starting IP Address	<p>When the Address Type field is configured to Single Address, enter a (static) IP address on the network behind the remote IPSec router. When the Address Type field is configured to Range Address, enter the beginning (static) IP address, in a range of computers on the network behind the remote IPSec router. When the Address Type field is configured to Subnet Address, enter a (static) IP address on the network behind the remote IPSec router.</p>
Ending IP Address / Subnet Mask	<p>When the Address Type field is configured to Single Address, this field is N/A. When the Address Type field is configured to Range Address, enter the end (static) IP address, in a range of computers on the network behind the remote IPSec router. When the Address Type field is configured to Subnet Address, enter a subnet mask on the network behind the remote IPSec router.</p>
DNS Server (for IPSec VPN)	<p>If there is a private DNS server that services the VPN, type its IP address here. The ZyWALL assigns this additional DNS server to the ZyWALL's DHCP clients that have IP addresses in this IPSec rule's range of local addresses.</p> <p>A DNS server allows clients on the VPN to find other computers and servers on the VPN by their (private) domain names.</p>
Authentication Method	<p>Select Pre-Shared Key to use a pre-shared key to identify the ZyWALL and the remote IPSec router. A pre-shared key identifies a communicating party during a phase 1 IKE negotiation. It is called "pre-shared" because you have to share it with another party before you can communicate with them over a secure connection.</p> <p>Select Certificate to identify the ZyWALL and the remote IPSec router by certificates.</p>

Table 15-7 VPN IKE

LABEL	DESCRIPTION
Pre-shared Key	<p>Type your pre-shared key in this field.</p> <p>Type from 8 to 31 case-sensitive ASCII characters or from 16 to 62 hexadecimal ("0-9", "A-F") characters. You must precede a hexadecimal key with a "0x" (zero x), which is not counted as part of the 16 to 62 character range for the key. For example, in "0x0123456789ABCDEF", "0x" denotes that the key is hexadecimal and "0123456789ABCDEF" is the key itself.</p> <p>Both ends of the VPN tunnel must use the same pre-shared key. You will receive a "PYLD_MALFORMED" (payload malformed) packet if the same pre-shared key is not used on both ends.</p>
Certificate	<p>Select the certificate to use for this VPN tunnel. You must have certificates already configured in the My Certificates screen (Click My Certificates and see the <i>Certificates</i> part for details).</p>
Local ID Type	<p>Select IP to identify this ZyWALL by its IP address. Select DNS to identify this ZyWALL by a domain name. Select E-mail to identify this ZyWALL by an e-mail address.</p> <p>You do not configure the local ID type and content when you set Authentication Method to Certificate. The ZyWALL takes them from the certificate you select.</p>
Content	<p>When you select IP in the Local ID Type field, type the IP address of your computer. The ZyWALL uses the IP address in the My IP Address field if you configure the local Content field to 0.0.0.0 or leave it blank.</p> <p>It is recommended that you type an IP address other than 0.0.0.0 in the local Content field or use the DNS or E-mail ID type in the following situations.</p> <ul style="list-style-type: none"> ➤ When there is a NAT router between the two IPSec routers. ➤ When you want the remote IPSec router to be able to distinguish between VPN connection requests that come in from IPSec routers with dynamic WAN IP addresses. <p>With DNS or E-mail in the Local ID Type field, type a domain name or e-mail address by which to identify this ZyWALL. Use up to 31 ASCII characters including spaces, although trailing spaces are truncated. The domain name or e-mail address is for identification purposes only and can be any string.</p>

Table 15-7 VPN IKE

LABEL	DESCRIPTION
Peer ID Type	<p>Select from the following when you set Authentication Method to Pre-Shared Key.</p> <ul style="list-style-type: none"> ➤ Select IP to identify the remote IPSec router by its IP address. ➤ Select DNS to identify the remote IPSec router by a domain name. ➤ Select E-mail to identify the remote IPSec router by an e-mail address. <p>Select from the following when you set Authentication Method to Certificate.</p> <ul style="list-style-type: none"> ➤ Select IP to identify the remote IPSec router by an IP address. The IP address must be the same as in the subject alternative name field of the certificate that the remote IPSec router uses for this VPN connection. ➤ Select DNS to identify the remote IPSec router by a domain name. The domain name must be the same as in the subject alternative name field of the certificate that the remote IPSec router uses for this VPN connection. ➤ Select E-mail to identify the remote IPSec router by an e-mail address. The e-mail address must be the same as in the subject alternative name field of the certificate that the remote IPSec router uses for this VPN connection. ➤ Select Subject Name to identify the remote IPSec router by a subject name when the certificate that the peer uses for this VPN connection does not contain a subject alternative name (such as IP or E-mail). The subject name must be the same as in the subject name field of the certificate that the remote IPSec router uses for this VPN connection. ➤ Select Any to have the ZyWALL ignore the Peer ID Type and Content. <p>When you select IP, DNS, E-mail or Subject Name, only one remote IPSec router can use this VPN connection with your ZyWALL.</p> <p>When you select Any, the ZyWALL accepts VPN connection attempts from any remote IPSec router that uses a valid certificate issued by one of the ZyWALL's trusted certification authorities. Although the remote IPSec router would still need to have the rest of the VPN settings properly configured. Use extended authentication to limit which remote IPSec routers with certificates can use this VPN connection.</p>

Table 15-7 VPN IKE

LABEL	DESCRIPTION	
Content	Peer ID Type	Peer ID Content when you set Authentication Method to Pre-Shared Key .
	IP	Type the IP address of the computer with which you will make the VPN connection. If you configure this field to 0.0.0.0 or leave it blank, the ZyWALL will use the address in the Secure Gateway Address field.
	DNS or E-Mail	Type a domain name or e-mail address by which to identify the remote IPsec router. Use up to 31 ASCII characters including spaces, although trailing spaces are truncated. The domain name or e-mail address is for identification purposes only and can be any string.
	<p>It is recommended that you type an IP address other than 0.0.0.0 or use the DNS or E-mail Peer ID Type with the following situations:</p> <ul style="list-style-type: none"> ➤ There is a NAT router between the two IPsec routers. ➤ You want the ZyWALL to distinguish between VPN connection requests coming in from remote IPsec routers with dynamic WAN IP addresses. 	
	Peer ID Type	Peer ID Content when you set Authentication Method to Certificate .
	IP	Type the same IP address as the subject alternative name field of the certificate the remote IPsec router will use for this VPN connection. If you configure this field as 0.0.0.0 or leave it blank, the ZyWALL uses the address in the Secure Gateway Address field. The ZyWALL checks the peer ID content against the IP address in the subject alternative name field of the remote IPsec router's certificate that it uses for this VPN connection.
	DNS or E-Mail	Type the same domain name or e-mail address as the subject alternative name field of the certificate the remote IPsec router will use for this VPN connection.
	Subject Name	Type the subject name of the certificate the remote IPsec router will use for this VPN connection.
	Any	The peer Content field is not available.
	<p>With Pre-Shared Key or Certificate, if you use IP as the peer ID type and configure the content as 0.0.0.0 (or blank) and the Secure Gateway Address is also configured as 0.0.0.0, the ZyWALL does not check the peer's ID content.</p> <p>Regardless of how you configure the ID Type and Content fields, active rules cannot have overlapping local and remote IP address ranges.</p>	

Table 15-7 VPN IKE

LABEL	DESCRIPTION
My IP Address	<p>Enter the WAN IP address of your ZyWALL. The VPN tunnel has to be rebuilt if this IP address changes.</p> <p>The following applies if this field is configured as 0.0.0.0:</p> <ul style="list-style-type: none"> ➤ The ZyWALL uses the current ZyWALL WAN IP address (static or dynamic) to set up the VPN tunnel. ➤ If the WAN connection goes down, the ZyWALL uses the dial backup IP address for the VPN tunnel when using dial backup or the LAN IP address when using traffic redirect. See the chapter on WAN for details on dial backup and traffic redirect.
Secure Gateway Address	<p>Type the WAN IP address or the URL (up to 31 characters) of the IPSec router with which you're making the VPN connection. Set this field to 0.0.0.0 if the remote IPSec router has a dynamic WAN IP address (the Key Management field must be set to IKE).</p> <p>In order to have more than one active rule with the Secure Gateway Address field set to 0.0.0.0, the ranges of the local IP addresses cannot overlap between rules.</p> <p>If you configure an active rule with 0.0.0.0 in the Secure Gateway Address field and the LAN's full IP address range as the local IP address, then you cannot configure any other active rules with the Secure Gateway Address field set to 0.0.0.0.</p>
Encapsulation Mode	Select Tunnel mode or Transport mode from the drop-down list box.
ESP	Select ESP if you want to use ESP (Encapsulation Security Payload). The ESP protocol (RFC 2406) provides encryption as well as some of the services offered by AH. If you select ESP here, you must select options from the Encryption Algorithm and Authentication Algorithm fields.
AH	Select AH if you want to use AH (Authentication Header Protocol). The AH protocol (RFC 2402) was designed for integrity, authentication, sequence integrity (replay resistance), and non-repudiation but not for confidentiality, for which the ESP was designed. If you select AH here, you must select options from the Authentication Algorithm field.

Table 15-7 VPN IKE

LABEL	DESCRIPTION
Encryption Algorithm	<p>Select DES, 3DES, AES or NULL from the drop-down list box.</p> <p>The ZyWALL and the remote IPSec router generate an encryption key from the Diffie-Hellman key exchange. The DES encryption algorithm uses a 56-bit key. Triple DES (3DES) is a variation on DES that uses a 168-bit key. As a result, 3DES is more secure than DES. It also requires more processing power, resulting in increased latency and decreased throughput. AES uses a 128-bit key. AES is faster than 3DES and provides a similar level of security.</p> <p>Select NULL to set up a tunnel without encryption. When you select NULL, you do not enter an encryption key.</p>
Authentication Algorithm	<p>Select SHA1 or MD5 from the drop-down list box. MD5 (Message Digest 5) and SHA1 (Secure Hash Algorithm) are hash algorithms used to authenticate packet data. The SHA1 algorithm is generally considered stronger than MD5, but is slower. Select MD5 for minimal security and SHA-1 for maximum security.</p>
Advanced	Click Advanced to configure more detailed settings of your IKE key management.
Apply	Click Apply to save your changes back to the ZyWALL.
Reset	Click Reset to begin configuring this screen afresh.

15.12 IKE Phases

There are two phases to every IKE (Internet Key Exchange) negotiation – phase 1 (Authentication) and phase 2 (Key Exchange). A phase 1 exchange establishes an IKE SA and the second one uses that SA to negotiate SAs for IPSec.

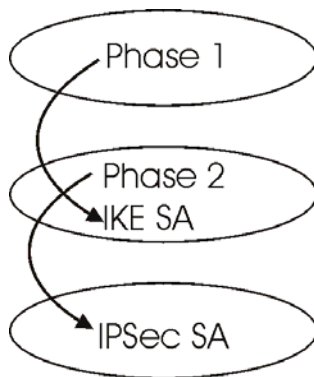

Figure 15-6 Two Phases to Set Up the IPSec SA

In phase 1 you must:

- Choose a negotiation mode.
- Authenticate the connection by entering a pre-shared key.
- Choose an encryption algorithm.
- Choose an authentication algorithm.
- Choose a Diffie-Hellman public-key cryptography key group (**DH1** or **DH2**).
- Set the IKE SA lifetime. This field allows you to determine how long an IKE SA should stay up before it times out. An IKE SA times out when the IKE SA lifetime period expires. If an IKE SA times out when an IPSec SA is already established, the IPSec SA stays connected.

In phase 2 you must:

- Choose which protocol to use (**ESP** or **AH**) for the IKE key exchange.
- Choose an encryption algorithm.
- Choose an authentication algorithm
- Choose whether to enable Perfect Forward Secrecy (PFS) using Diffie-Hellman public-key cryptography – see *section 15.12.4*. Select **None** (the default) to disable PFS.
- Choose **Tunnel** mode or **Transport** mode.
- Set the IPSec SA lifetime. This field allows you to determine how long the IPSec SA should stay up before it times out. The ZyWALL automatically renegotiates the IPSec SA if there is traffic when the IPSec SA lifetime period expires. The ZyWALL also automatically renegotiates the IPSec SA if both IPSec routers have keep alive enabled, even if there is no traffic. If an IPSec SA times out, then the IPSec router must renegotiate the SA the next time someone attempts to send traffic.

15.12.1 Extended Authentication and IKE

Extended authentication inserts a new exchange between IKE phases 1 and 2 for client authentication.

15.12.2 Negotiation Mode

The phase 1 **Negotiation Mode** you select determines how the Security Association (SA) will be established for each connection through IKE negotiations.

- **Main Mode** ensures the highest level of security when the communicating parties are negotiating authentication (phase 1). It uses 6 messages in three round trips: SA negotiation, Diffie-Hellman exchange and an exchange of nonces (a nonce is a random number). This mode features identity protection (your identity is not revealed in the negotiation).
- **Aggressive Mode** is quicker than **Main Mode** because it eliminates several steps when the communicating parties are negotiating authentication (phase 1). However the trade-off is that faster speed limits its negotiating power and it also does not provide identity protection. It is useful in remote access situations where the address of the initiator is not known by the responder and both parties want to use pre-shared key authentication.

15.12.3 Diffie-Hellman (DH) Key Groups

Diffie-Hellman (DH) is a public-key cryptography protocol that allows two parties to establish a shared secret over an unsecured communications channel. Diffie-Hellman is used within IKE SA setup to establish session keys. 768-bit (Group 1 - **DH1**) and 1024-bit (Group 2 – **DH2**) Diffie-Hellman groups are supported. Upon completion of the Diffie-Hellman exchange, the two peers have a shared secret, but the IKE SA is not authenticated. For authentication, use pre-shared keys.

15.12.4 Perfect Forward Secrecy (PFS)

Enabling PFS means that the key is transient. The key is thrown away and replaced by a brand new key using a new Diffie-Hellman exchange for each new IPSec SA setup. With PFS enabled, if one key is compromised, previous and subsequent keys are not compromised, because subsequent keys are not derived from previous keys. The (time-consuming) Diffie-Hellman exchange is the trade-off for this extra security.

This may be unnecessary for data that does not require such security, so PFS is disabled (**None**) by default in the ZyWALL. Disabling PFS means new authentication and encryption keys are derived from the same root secret (which may have security implications in the long run) but allows faster SA setup (by bypassing the Diffie-Hellman key exchange).

15.13 Configuring Advanced IKE Settings

Select **Advanced** at the bottom of the **VPN IKE** screen. This is the **VPN IKE- Advanced** screen as shown next.

VPN - VPN RULE - EDIT - ADVANCED

Protocol
Enable Replay Detection
Local Port
 Start
 End
Remote Port
 Start
 End

Phase 1
 Negotiation Mode
 Encryption Algorithm
 Authentication Algorithm
 SA Life Time (Seconds)
 Key Group

Phase 2
 Active Protocol
 Encryption Algorithm
 Authentication Algorithm
 SA Life Time (Seconds)
 Encapsulation
 Perfect Forward Secrecy(PFS)

Figure 15-7 VPN IKE: Advanced

The following table describes the labels in this screen.

Table 15-8 VPN IKE: Advanced

LABEL	DESCRIPTION
Protocol	Enter 1 for ICMP, 6 for TCP, 17 for UDP, etc. 0 is the default and signifies any protocol.

Table 15-8 VPN IKE: Advanced

LABEL	DESCRIPTION
Enable Replay Detection	As a VPN setup is processing intensive, the system is vulnerable to Denial of Service (DoS) attacks. The IPsec receiver can detect and reject old or duplicate packets to protect against replay attacks. Select YES from the drop-down menu to enable replay detection, or select NO to disable it.
Local Port Start	"0" is the default and signifies any port. Type a port number from 0 to 65535. Some of the most common IP ports are: 21, FTP; 53, DNS; 23, Telnet; 80, HTTP; 25, SMTP; 110, POP3.
Local Port End	Type a port number in this field to define a port range. This port number must be greater than that specified in the previous field. If Local Port Start is left at 0, Local Port End will also remain at 0.
Remote Port Start	Type up to 32 characters to identify this VPN policy. You may use any character, including spaces, but the ZyWALL drops trailing spaces.
Remote Port End	Enter a port number in this field to define a port range. This port number must be greater than that specified in the previous field. If Remote Port Start is left at 0, Remote Port End will also remain at 0.
Phase 1	
Negotiation Mode	Select Main or Aggressive from the drop-down list box. Multiple SAs connecting through a secure gateway must have the same negotiation mode.
Encryption Algorithm	Select DES , 3DES or AES from the drop-down list box. The ZyWALL and the remote IPsec router generate an encryption key from the Diffie-Hellman key exchange. The DES encryption algorithm uses a 56-bit key. Triple DES (3DES) is a variation on DES that uses a 168-bit key. As a result, 3DES is more secure than DES . It also requires more processing power, resulting in increased latency and decreased throughput. AES uses a 128-bit key. AES is faster than 3DES and provides a similar level of security.
Authentication Algorithm	Select SHA1 or MD5 from the drop-down list box. MD5 (Message Digest 5) and SHA1 (Secure Hash Algorithm) are hash algorithms used to authenticate packet data. The SHA1 algorithm is generally considered stronger than MD5 , but is slower. Select MD5 for minimal security and SHA-1 for maximum security.
SA Life Time (seconds)	Define the length of time before an IKE SA automatically renegotiates in this field. It may range from 60 to 3,000,000 seconds (almost 35 days). A short SA Life Time increases security by forcing the two VPN gateways to update the encryption and authentication keys. However, every time the VPN tunnel renegotiates, all users accessing remote resources are temporarily disconnected.

Table 15-8 VPN IKE: Advanced

LABEL	DESCRIPTION
Key Group	You must choose a key group for phase 1 IKE setup. DH1 (default) refers to Diffie-Hellman Group 1 a 768 bit random number. DH2 refers to Diffie-Hellman Group 2 a 1024 bit (1Kb) random number.
Phase 2	
Active Protocol	Use the drop-down list box to choose from ESP or AH .
Encryption Algorithm	<p>Select DES, 3DES, AES or NULL from the drop-down list box.</p> <p>The ZyWALL and the remote IPsec router generate an encryption key from the Diffie-Hellman key exchange. The DES encryption algorithm uses a 56-bit key. Triple DES (3DES) is a variation on DES that uses a 168-bit key. As a result, 3DES is more secure than DES. It also requires more processing power, resulting in increased latency and decreased throughput. AES uses a 128-bit key. AES is faster than 3DES and provides a similar level of security.</p> <p>Select NULL to set up a tunnel without encryption. When you select NULL, you do not enter an encryption key.</p>
Authentication Algorithm	Select SHA1 or MD5 from the drop-down list box. MD5 (Message Digest 5) and SHA1 (Secure Hash Algorithm) are hash algorithms used to authenticate packet data. The SHA1 algorithm is generally considered stronger than MD5 , but is slower. Select MD5 for minimal security and SHA-1 for maximum security.
SA Life Time (seconds)	<p>Define the length of time before an IKE SA automatically renegotiates in this field. It may range from 60 to 3,000,000 seconds (almost 35 days).</p> <p>A short SA Life Time increases security by forcing the two VPN gateways to update the encryption and authentication keys. However, every time the VPN tunnel renegotiates, all users accessing remote resources are temporarily disconnected.</p>
Encapsulation	Select Tunnel mode or Transport mode from the drop-down list box.
Perfect Forward Secrecy (PFS)	Perfect Forward Secrecy (PFS) is disabled (NONE) by default in phase 2 IPsec SA setup. This allows faster IPsec setup, but is not so secure. Choose DH1 or DH2 from the drop-down list box to enable PFS. DH1 refers to Diffie-Hellman Group 1 a 768 bit random number. DH2 refers to Diffie-Hellman Group 2 a 1024 bit (1Kb) random number (more secure, yet slower).
Apply	Click Apply to save your changes back to the ZyWALL and return to the Configure-IKE screen.
Cancel	Click Cancel to return to the Configure-IKE screen without saving your changes.

15.14 Manual Key Setup

Manual key management is useful if you have problems with **IKE** key management.

15.14.1 Security Parameter Index (SPI)

An SPI is used to distinguish different SAs terminating at the same destination and using the same IPSec protocol. This data allows for the multiplexing of SAs to a single gateway. The **SPI** (Security Parameter Index) along with a destination IP address uniquely identify a particular Security Association (SA). The **SPI** is transmitted from the remote VPN gateway to the local VPN gateway. The local VPN gateway then uses the network, encryption and key values that the administrator associated with the SPI to establish the tunnel.

Current ZyXEL implementation assumes identical outgoing and incoming SPIs.

15.15 Configuring Manual Key

You only configure **VPN Manual Key** when you select **Manual** in the **Key Management** field on the **VPN IKE** screen. This is the **VPN Manual Key** screen as shown next.

VPN - MANUAL KEY

Active

Name

Key Management

Local :

Address Type

Starting IP Address

Ending IP Address / Subnet Mask

Remote :

Address Type

Starting IP Address

Ending IP Address / Subnet Mask

DNS Server (for IPsec VPN)

My IP Address

Secure Gateway Address

SPI

Encapsulation Mode

ESP AH

Encryption Algorithm Authentication Algorithm

Authentication Algorithm

Encryption Key

Authentication Key

Figure 15-8 VPN Manual Key

The following table describes the labels in this screen.

Table 15-9 VPN Manual Key

LABEL	DESCRIPTION
Active	Select this check box to activate this VPN policy.
Name	Type up to 32 characters to identify this VPN policy. You may use any character, including spaces, but the ZyWALL drops trailing spaces.
Key Management	Select IKE or Manual Key from the drop-down list box. Manual is a useful option for troubleshooting if you have problems using IKE key management.

Table 15-9 VPN Manual Key

LABEL	DESCRIPTION
Local	<p>Local IP addresses must be static and correspond to the remote IPSec router's configured remote IP addresses.</p> <p>Two active SAs cannot have the local and remote IP address(es) both the same. Two active SAs can have the same local or remote IP address, but not both. You can configure multiple SAs between the same local and remote IP addresses, as long as only one is active at any time.</p>
Address Type	<p>Use the drop-down list box to choose Single Address, Range Address, or Subnet Address. Select Single Address for a single IP address. Select Range Address for a specific range of IP addresses. Select Subnet Address to specify IP addresses on a network by their subnet mask.</p>
Starting IP Address	<p>When the Address Type field is configured to Single Address, enter a (static) IP address on the LAN behind your ZyWALL. When the Address Type field is configured to Range Address, enter the beginning (static) IP address, in a range of computers on the LAN behind your ZyWALL. When the Address Type field is configured to Subnet Address, this is a (static) IP address on the LAN behind your ZyWALL.</p>
Ending IP Address/Subnet Mask	<p>When the Address Type field is configured to Single Address, this field is N/A. When the Address Type field is configured to Range Address, enter the end (static) IP address, in a range of computers on the LAN behind your ZyWALL. When the Address Type field is configured to Subnet Address, this is a subnet mask on the LAN behind your ZyWALL.</p>
Remote	<p>Remote IP addresses must be static and correspond to the remote IPSec router's configured local IP addresses.</p> <p>Two active SAs cannot have the local and remote IP address(es) both the same. Two active SAs can have the same local or remote IP address, but not both. You can configure multiple SAs between the same local and remote IP addresses, as long as only one is active at any time.</p>
Address Type	<p>Use the drop-down list box to choose Single Address, Range Address, or Subnet Address. Select Single Address with a single IP address. Select Range Address for a specific range of IP addresses. Select Subnet Address to specify IP addresses on a network by their subnet mask.</p>
Starting IP Address	<p>When the Address Type field is configured to Single Address, enter a (static) IP address on the network behind the remote IPSec router. When the Addr Type field is configured to Range Address, enter the beginning (static) IP address, in a range of computers on the network behind the remote IPSec router. When the Address Type field is configured to Subnet Address, enter a (static) IP address on the network behind the remote IPSec router.</p>

Table 15-9 VPN Manual Key

LABEL	DESCRIPTION
Ending IP Address/Subnet Mask	When the Address Type field is configured to Single Address , this field is N/A. When the Address Type field is configured to Range Address , enter the end (static) IP address, in a range of computers on the network behind the remote IPsec router. When the Address Type field is configured to Subnet Address , enter a subnet mask on the network behind the remote IPsec router.
DNS Server (for IPsec VPN)	If there is a private DNS server that services the VPN, type its IP address here. The ZyWALL assigns this additional DNS server to the ZyWALL's DHCP clients that have IP addresses in this IPsec rule's range of local addresses. A DNS server allows clients on the VPN to find other computers and servers on the VPN by their (private) domain names.
My IP Address	Enter the WAN IP address of your ZyWALL. The ZyWALL uses its current WAN IP address (static or dynamic) in setting up the VPN tunnel if you leave this field as 0.0.0.0 . The VPN tunnel has to be rebuilt if this IP address changes.
Secure Gateway Addr	Type the WAN IP address or the URL (up to 31 characters) of the IPsec router with which you're making the VPN connection.
SPI	Type a number (base 10) from 1 to 999999 for the Security Parameter Index.
Encapsulation Mode	Select Tunnel mode or Transport mode from the drop-down list box.
ESP	Select ESP if you want to use ESP (Encapsulation Security Payload). The ESP protocol (RFC 2406) provides encryption as well as some of the services offered by AH. If you select ESP here, you must select options from the Encryption Algorithm and Authentication Algorithm fields.
AH	Select AH if you want to use AH (Authentication Header Protocol). The AH protocol (RFC 2402) was designed for integrity, authentication, sequence integrity (replay resistance), and non-repudiation but not for confidentiality, for which the ESP was designed. If you select AH here, you must select options from the Authentication Algorithm field.
Encryption Algorithm	Select DES , 3DES or NULL from the drop-down list box. When you use DES or 3DES , both sender and receiver must know the Encryption Key , which can be used to encrypt and decrypt the messages. The DES encryption algorithm uses a 56-bit key. Triple DES (3DES) is a variation on DES that uses a 168-bit key. As a result, 3DES is more secure than DES . It also requires more processing power, resulting in increased latency and decreased throughput. Select NULL to set up a tunnel without encryption. When you select NULL , you do not enter an encryption key.

Table 15-9 VPN Manual Key

LABEL	DESCRIPTION
Authentication Algorithm	When you use SHA1 or MD5 , both sender and receiver must know the Authentication Key , which can be used to generate and verify a message authentication code. Select SHA1 or MD5 from the drop-down list box. MD5 (Message Digest 5) and SHA1 (Secure Hash Algorithm) are hash algorithms used to authenticate packet data. The SHA1 algorithm is generally considered stronger than MD5 , but is slower. Select MD5 for minimal security and SHA-1 for maximum security.
Encryption Key	This field only applies when you select ESP . With DES , type a unique key 8 ASCII characters long. With 3DES , type a unique key 24 ASCII characters long. Any characters may be used, including spaces, but trailing spaces are truncated.
Authentication Key	Type a unique authentication key to be used by IPSec if applicable. Enter 16 characters for MD5 authentication or 20 characters for SHA-1 authentication. Any characters may be used, including spaces, but trailing spaces are truncated.
Apply	Click Apply to save your changes back to the ZyWALL.
Cancel	Click Cancel to begin configuring this screen afresh.

15.16 Viewing SA Monitor

In the web configurator, click **VPN** and the **SA Monitor** tab. Use this screen to display and manage active VPN connections.

A Security Association (SA) is the group of security settings related to a specific VPN tunnel. This screen displays active VPN connections. Use **Refresh** to display active VPN connections. This screen is read-only. The following table describes the fields in this tab.

When there is outbound traffic but no inbound traffic, the SA times out automatically after two minutes. A tunnel with no outbound or inbound traffic is "idle" and does not timeout until the SA lifetime period expires. See section 15.6 on keep alive to have the ZyWALL renegotiate an IPSec SA when the SA lifetime expires, even if there is no traffic.

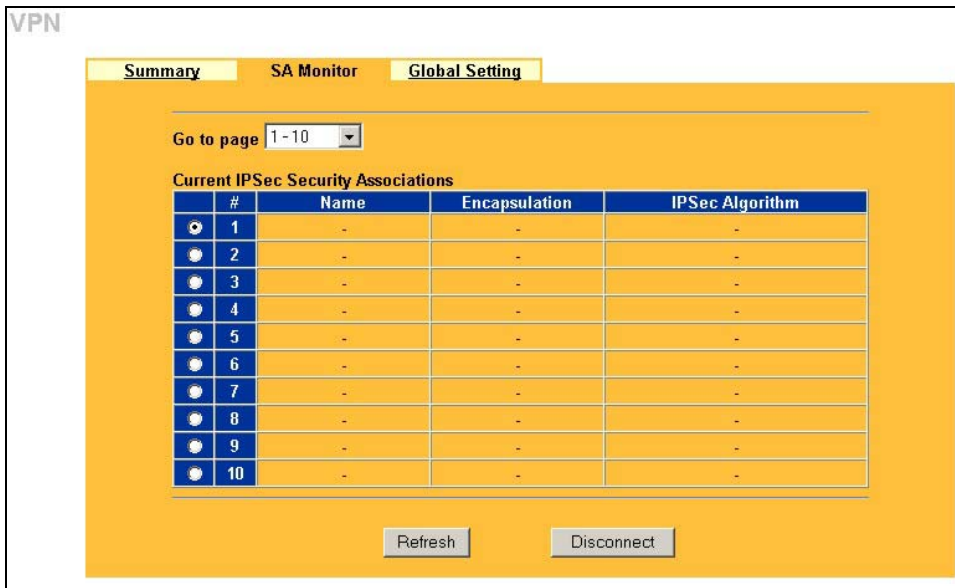

Figure 15-9 SA Monitor (ZyWALL 100)

The following table describes the labels in this screen.

Table 15-10 SA Monitor

LABEL	DESCRIPTION
Go to page	Choose the range of rules from the drop-down list box to display the summary page for the selected rules. Not all ZyWALL models have this Go to page feature.
#	This is the security association index number.
Name	This field displays the identification name for this VPN policy.
Encapsulation	This field displays Tunnel or Transport mode.
IPsec Algorithm	This field displays the security protocols used for an SA. Both AH and ESP increase ZyWALL processing requirements and communications latency (delay).
Previous Page (if applicable)	Click Previous Page to view more items in the summary (not all ZyWALL models have this feature).
Refresh	Click Refresh to display the current active VPN connection(s).

Table 15-10 SA Monitor

LABEL	DESCRIPTION
Disconnect	Select a security association index number that you want to disconnect and then click Disconnect .
Next Page	Click Next Page to view more items in the summary (not all ZyWALL models have this feature).

15.17 Configuring Global Setting

To change your ZyWALL's Global Settings, click **VPN**, then the **Global Setting** tab. The screen appears as shown.

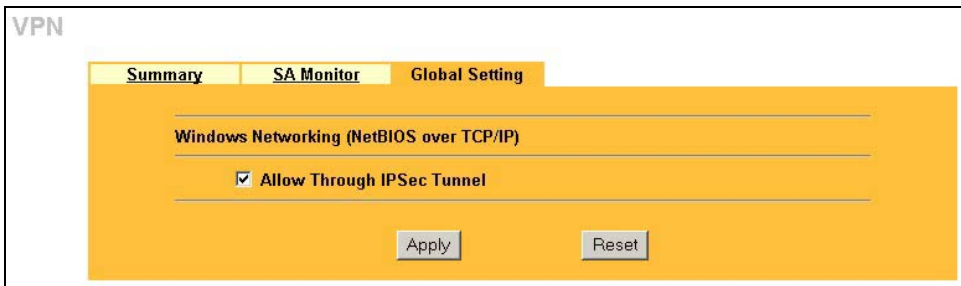
**Figure 15-10 Global Setting**

The following table describes the labels in this screen.

Table 15-11 Global Setting

LABEL	DESCRIPTION
Windows Networking (NetBIOS over TCP/IP)	NetBIOS (Network Basic Input/Output System) are TCP or UDP broadcast packets that enable a computer to find other computers. It may sometimes be necessary to allow NetBIOS packets to pass through VPN tunnels in order to allow local computers to find computers on the remote network and vice versa.
Allow Through IP/Sec Tunnel	Select this check box to send NetBIOS packets through the VPN connection.
Apply	Click Apply to save your changes back to the ZyWALL.
Reset	Click Reset to begin configuring this screen afresh.

15.18 Telecommuter VPN/IPSec Examples

The following examples show how multiple telecommuters can make VPN connections to a single ZyWALL at headquarters. The telecommuters use IPSec routers with dynamic WAN IP addresses. The ZyWALL at headquarters has a static public IP address.

15.18.1 Telecommuters Sharing One VPN Rule Example

See the following figure and table for an example configuration that allows multiple telecommuters (A, B and C in the figure) to use one VPN rule to simultaneously access a ZyWALL at headquarters (HQ in the figure). The telecommuters do not have domain names mapped to the WAN IP addresses of their IPSec routers. The telecommuters must all use the same IPSec parameters but the local IP addresses (or ranges of addresses) should not overlap.

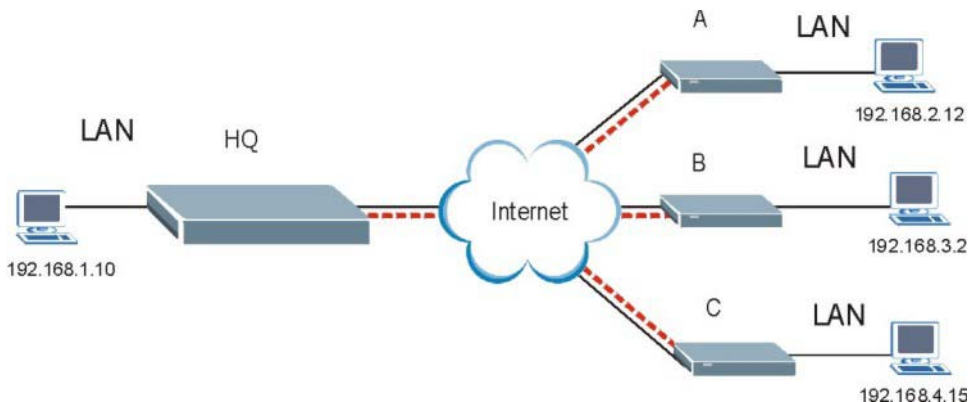

Figure 15-11 Telecommuters Sharing One VPN Rule Example

Table 15-12 Telecommuters Sharing One VPN Rule Example

FIELDS	HEADQUARTERS	TELECOMMUTERS
My IP Address:	Public static IP address	0.0.0.0 (dynamic IP address assigned by the ISP)
Secure Gateway IP Address:	0.0.0.0 With this IP address only the telecommuter can initiate the IPSec tunnel.	Public static IP address
Local IP Address:	192.168.1.10	Telecommuter A: 192.168.2.12 Telecommuter B: 192.168.3.2 Telecommuter C: 192.168.4.15

Table 15-12 Telecommuters Sharing One VPN Rule Example

FIELDS	HEADQUARTERS	TELECOMMUTERS
Remote IP Address:	0.0.0.0 (N/A)	192.168.1.10

15.18.2 Telecommuters Using Unique VPN Rules Example

In this example the telecommuters (A, B and C in the figure) use IPSec routers with domain names that are mapped to their dynamic WAN IP addresses (use Dynamic DNS to do this).

With aggressive negotiation mode (see *section 15.12.2*), the ZyWALL can use the ID types and contents to distinguish between VPN rules. Telecommuters can each use a separate VPN rule to simultaneously access a ZyWALL at headquarters. They can use different IPSec parameters. The local IP addresses (or ranges of addresses) of the rules configured on the ZyWALL at headquarters can overlap. The local IP addresses of the rules configured on the telecommuters' IPSec routers should not overlap.

See the following table and figure for an example where three telecommuters each use a different VPN rule for a VPN connection with a ZyWALL located at headquarters. The ZyWALL at headquarters (HQ in the figure) identifies each incoming SA by its ID type and content and uses the appropriate VPN rule to establish the VPN connection.

The ZyWALL at headquarters can also initiate VPN connections to the telecommuters since it can find the telecommuters by resolving their domain names.

**Figure 15-12 Telecommuters Using Unique VPN Rules Example**

Table 15-13 Telecommuters Using Unique VPN Rules Example

HEADQUARTERS	TELECOMMUTERS
All Headquarters Rules:	All Telecommuter Rules:
My IP Address: bigcompanyhq.com	My IP Address 0.0.0.0
Local IP Address: 192.168.1.10	Secure Gateway Address: bigcompanyhq.com
Local ID Type: E-mail	Remote IP Address: 192.168.1.10
Local ID Content: bob@bigcompanyhq.com	Peer ID Type: E-mail
	Peer ID Content: bob@bigcompanyhq.com
Headquarters ZyWALL Rule 1:	Telecommuter A (telecommutera.dydns.org)
Peer ID Type: IP	Local ID Type: IP
Peer ID Content: 192.168.2.12	Local ID Content: 192.168.2.12
Secure Gateway Address: telecommuter1.com	Local IP Address: 192.168.2.12
Remote Address 192.168.2.12	
Headquarters ZyWALL Rule 2:	Telecommuter B (telecommuterb.dydns.org)
Peer ID Type: DNS	Local ID Type: DNS
Peer ID Content: telecommuterb.com	Local ID Content: telecommuterb.com
Secure Gateway Address: telecommuterb.com	Local IP Address: 192.168.3.2
Remote Address 192.168.3.2	
Headquarters ZyWALL Rule 3:	Telecommuter C (telecommuterc.dydns.org)
Peer ID Type: E-mail	Local ID Type: E-mail
Peer ID Content: myVPN@myplace.com	Local ID Content: myVPN@myplace.com
Secure Gateway Address: telecommuterc.com	Local IP Address: 192.168.4.15
Remote Address 192.168.4.15	

15.19VPN and Remote Management

If a VPN tunnel uses Telnet, FTP, WWW, SNMP, DNS or ICMP, then you should configure remote management (**REMOTE MGNT**) to allow access for that service.

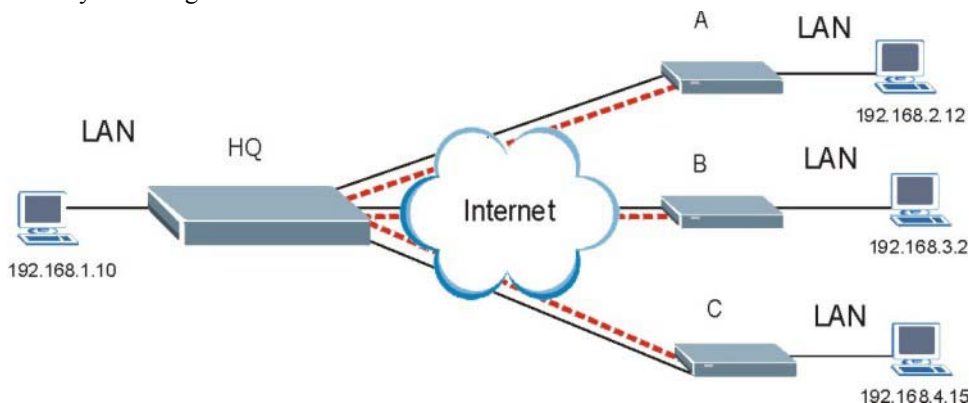
Part VII:

Certificates

This part provides information and configuration instructions for public-key certificates.

Chapter 16

Certificates

This chapter gives background information about public-key certificates and explains how to use them.

16.1 Certificates Overview

The ZyWALL can use certificates (also called digital IDs) to authenticate users. Certificates are based on public-private key pairs. A certificate contains the certificate owner's identity and public key. Certificates provide a way to exchange public keys for use in authentication.

A Certification Authority (CA) issues certificates and guarantees the identity of each certificate owner. There are commercial certification authorities like CyberTrust or VeriSign and government certification authorities. You can use the ZyWALL to generate certification requests that contain identifying information and public keys and then send the certification requests to a certification authority.

In public-key encryption and decryption, each host has two keys. One key is public and can be made openly available; the other key is private and must be kept secure. Public-key encryption in general works as follows.

1. Tim wants to send a private message to Jenny. Tim generates a public key pair. What is encrypted with one key can only be decrypted using the other.
2. Tim keeps the private key and makes the public key openly available.
3. Tim uses his private key to encrypt the message and sends it to Jenny.
4. Jenny receives the message and uses Tim's public key to decrypt it.
5. Additionally, Jenny uses her own private key to encrypt a message and Tim uses Jenny's public key to decrypt the message.

The ZyWALL uses certificates based on public-key cryptology to authenticate users attempting to establish a connection, not to encrypt the data that you send after establishing a connection. The method used to secure the data that you send through an established connection depends on the type of connection. For example, a VPN tunnel might use the triple DES encryption algorithm.

The certification authority uses its private key to sign certificates. Anyone can then use the certification authority's public key to verify the certificates.

A certification path is the hierarchy of certification authority certificates that validate a certificate. The ZyWALL does not trust a certificate if any certificate on its path has expired or been revoked.

Certification authorities maintain directory servers with databases of valid and revoked certificates. A directory of certificates that have been revoked before the scheduled expiration is called a CRL (Certificate Revocation List). The ZyWALL can check a peer's certificate against a directory server's list of revoked certificates. The framework of servers, software, procedures and policies that handles keys is called PKI (public-key infrastructure).

16.1.1 Advantages of Certificates

Certificates offer the following benefits.

- The ZyWALL only has to store the certificates of the certification authorities that you decide to trust, no matter how many devices you need to authenticate.
- Key distribution is simple and very secure since you can freely distribute public keys and you never need to transmit private keys.

16.2 Self-signed Certificates

Until public-key infrastructure becomes more mature, it may not be available in some areas. You can have the ZyWALL act as a certification authority and sign its own certificates.

16.3 Configuration Summary

This section summarizes how to manage certificates on the ZyWALL.

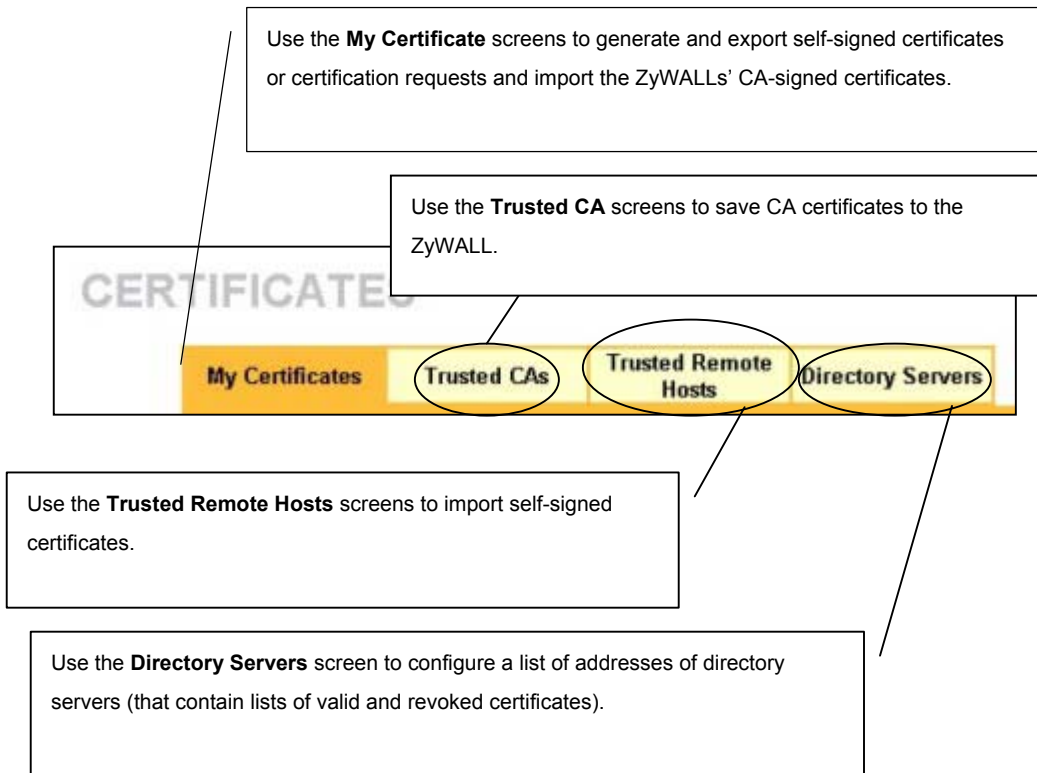

Figure 16-1 Certificate Configuration Overview

16.4 My Certificates

Click **CERTIFICATES**, **My Certificates** to open the ZyWALL's summary list of certificates and certification requests. Certificates display in black and certification requests display in gray. See the following figure.

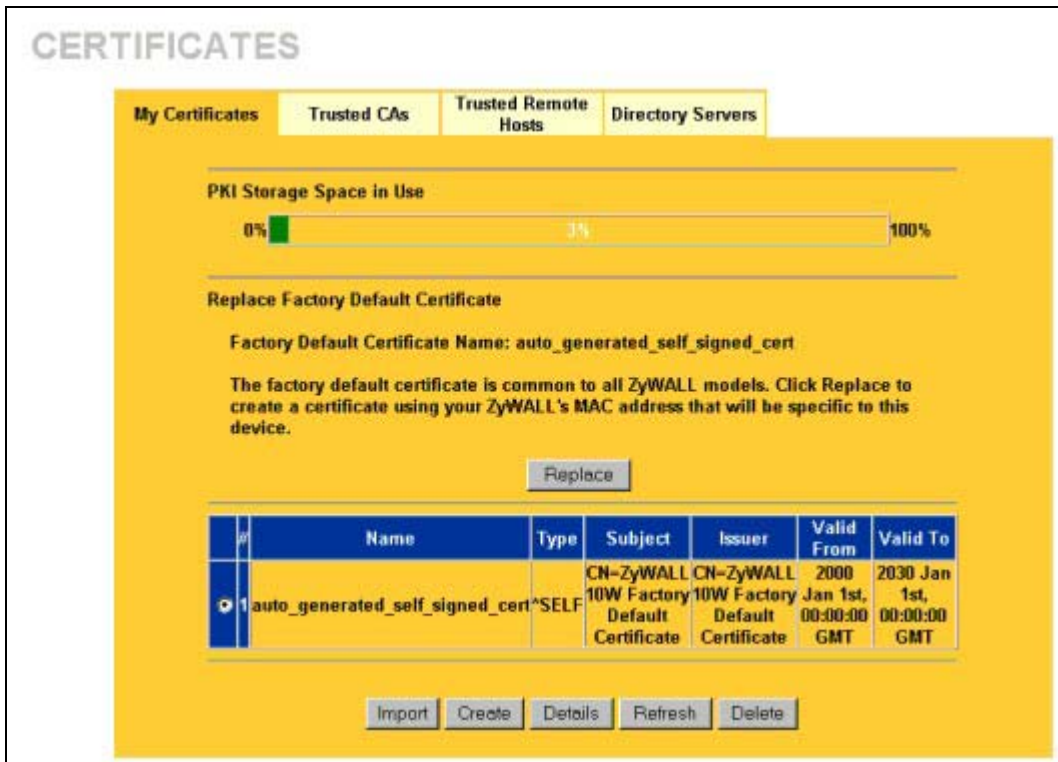

Figure 16-2 My Certificates

The following table describes the labels in this screen.

Table 16-1 My Certificates

LABEL	DESCRIPTION
PKI Storage Space in Use	This bar displays the percentage of the ZyWALL's PKI storage space that is currently in use. When you are using 80% or less of the storage space, the bar is green. When the amount of space used is over 80%, the bar is red. When the bar is red, you should consider deleting expired or unnecessary certificates before adding more certificates.

Table 16-1 My Certificates

LABEL	DESCRIPTION
Replace	This button displays when the ZyWALL has the factory default certificate. The factory default certificate is common to all ZyWALLs that use certificates. ZyXEL recommends that you use this button to replace the factory default certificate with one that uses your ZyWALL's MAC address.
#	This field displays the certificate index number. The certificates are listed in alphabetical order.
Name	This field displays the name used to identify this certificate. It is recommended that you give each certificate a unique name.
Type	<p>This field displays what kind of certificate this is.</p> <p>REQ represents a certification request and is not yet a valid certificate. Send a certification request to a certification authority, which then issues a certificate. Use the My Certificate Import screen to import the certificate and replace the request.</p> <p>SELF represents a self-signed certificate.</p> <p>*SELF represents the default self-signed certificate, which the ZyWALL uses to sign imported trusted remote host certificates.</p> <p>CERT represents a certificate issued by a certification authority.</p>
Subject	This field displays identifying information about the certificate's owner, such as CN (Common Name), OU (Organizational Unit or department), O (Organization or company) and C (Country). It is recommended that each certificate have unique subject information.
Issuer	This field displays identifying information about the certificate's issuing certification authority, such as a common name, organizational unit or department, organization or company and country. With self-signed certificates, this is the same information as in the Subject field.
Valid From	This field displays the date that the certificate becomes applicable. The text displays in red and includes a "Not Yet Valid!" message if the certificate has not yet become applicable.
Valid To	This field displays the date that the certificate expires. The text displays in red and includes an "Expiring!" or "Expired!" message if the certificate is about to expire or has already expired.
Import	Click Import to open a screen where you can save the certificate that you have enrolled from a certification authority from your computer to the ZyWALL.
Create	Click Create to go to the screen where you can have the ZyWALL generate a certificate or a certification request.

Table 16-1 My Certificates

LABEL	DESCRIPTION
Details	Select the radio button next to a certificate's index number and then click Details to open a screen with an in-depth list of information about that certificate.
Refresh	Click this button to display the current validity status of the certificates.
Delete	<p>Select the radio button next to the index number of a certificate that you want to delete and then click Delete to remove that certificate.</p> <p>You cannot delete a certificate that one or more features is configured to use.</p> <p>Do the following to delete a certificate that shows *SELF in the Type field.</p> <ol style="list-style-type: none"> 1. Make sure that no other features, such as HTTPS, VPN, SSH ... are configured to use the *SELF certificate. 2. Click the details icon next to another self-signed certificate (see the section on the Create button if you need to create a self-signed certificate). 3. Select the Default self-signed certificate which signs the imported remote host certificates check box. 4. Click Apply to save the changes and return to the My Certificates screen. 5. The certificate that originally showed *SELF displays SELF and you can delete it now. <p>Note that subsequent certificates move up by one when you take this action.</p>

16.5 Certificate File Formats

The certification authority certificate that you want to import has to be in one of these file formats:

- Binary X.509: This is an ITU-T recommendation that defines the formats for X.509 certificates.
- PEM (Base-64) encoded X.509: This Privacy Enhanced Mail format uses 64 ASCII characters to convert a binary X.509 certificate into a printable form.
- Binary PKCS#7: This is a standard that defines the general syntax for data (including digital signatures) that may be encrypted. The ZyWALL currently allows the importation of a PKS#7 file that contains a single certificate.
- PEM (Base-64) encoded PKCS#7: This Privacy Enhanced Mail (PEM) format uses 64 ASCII characters to convert a binary PKCS#7 certificate into a printable form.

16.6 Importing a Certificate

Click **CERTIFICATES**, **My Certificates** and then **Import** to open the **My Certificate Import** screen. Follow the instructions in this screen to save an existing certificate to the ZyWALL, see the following figure.

- 1. You can only import a certificate that matches a corresponding certification request that was generated by the ZyWALL.**
- 2. The certificate you import replaces the corresponding request in the My Certificates screen.**
- 3. You must remove any spaces from the certificate's filename before you can import it.**



Figure 16-3 My Certificate Import

The following table describes the labels in this screen.

Table 16-2 My Certificate Import

LABEL	DESCRIPTION
File Path	Type in the location of the file you want to upload in this field or click Browse to find it.
Browse	Click Browse to find the certificate file you want to upload.
Apply	Click Apply to save the certificate on the ZyWALL.
Cancel	Click Cancel to quit and return to the My Certificates screen.

16.7 Creating a Certificate

Click **CERTIFICATES**, **My Certificates** and then **Create** to open the **My Certificate Create** screen. Use this screen to have the ZyWALL create a self-signed certificate, enroll a certificate with a certification authority or generate a certification request, see the following figure.

CERTIFICATES - MY CERTIFICATE - CREATE

Certificate Name

Subject Information

Common Name

Host IP Address

Host Domain Name

E-Mail

Organizational Unit

Organization

Country

Key Length bits

Create a self-signed certificate

Create a certification request and save it locally for later manual enrollment

Create a certification request and enroll for a certificate immediately online

Enrollment Protocol

CA Server Address

CA Certificate [\(See Trusted CAs\)](#)

Request Authentication

Reference Number

Key

Figure 16-4 My Certificate Create

The following table describes the labels in this screen.

Table 16-3 My Certificate Create

LABEL	DESCRIPTION
Certificate Name	Type up to 31 ASCII characters (not including spaces) to identify this certificate.

Table 16-3 My Certificate Create

LABEL	DESCRIPTION
Subject Information	Use these fields to record information that identifies the owner of the certificate. You do not have to fill in every field, although the Common Name is mandatory. The certification authority may add fields (such as a serial number) to the subject information when it issues a certificate. It is recommended that each certificate have unique subject information.
Common Name	Select a radio button to identify the certificate's owner by IP address, domain name or e-mail address. Type the IP address (in dotted decimal notation), domain name or e-mail address in the field provided. The domain name or e-mail address can be up to 31 ASCII characters. The domain name or e-mail address is for identification purposes only and can be any string.
Organizational Unit	Type up to 127 characters to identify the organizational unit or department to which the certificate owner belongs. You may use any character, including spaces, but the ZyWALL drops trailing spaces.
Organization	Type up to 127 characters to identify the company or group to which the certificate owner belongs. You may use any character, including spaces, but the ZyWALL drops trailing spaces.
Country	Type up to 127 characters to identify the nation where the certificate owner is located. You may use any character, including spaces, but the ZyWALL drops trailing spaces.
Key Length	Select a number from the drop-down list box to determine how many bits the key should use (512 to 2048). The longer the key, the more secure it is. A longer key also uses more PKI storage space.
These radio buttons deal with how and when the certificate is to be generated.	
Create a self-signed certificate	Select Create a self-signed certificate to have the ZyWALL generate the certificate and act as the Certification Authority (CA) itself. This way you do not need to apply to a certification authority for certificates.
Create a certification request and save it locally for later manual enrollment	<p>Select Create a certification request and save it locally for later manual enrollment to have the ZyWALL generate and store a request for a certificate. Use the My Certificate Details screen to view the certification request and copy it to send to the certification authority.</p> <p>Copy the certification request from the My Certificate Details screen (see section 16.8) and then send it to the certification authority.</p>

Table 16-3 My Certificate Create

LABEL	DESCRIPTION
Create a certification request and enroll for a certificate immediately online	<p>Select Create a certification request and enroll for a certificate immediately online to have the ZyWALL generate a request for a certificate and apply to a certification authority for a certificate.</p> <p>You must have the certification authority's certificate already imported in the Trusted CAs screen.</p> <p>When you select this option, you must select the certification authority's enrollment protocol and the certification authority's certificate from the drop-down list boxes and enter the certification authority's server address. You also need to fill in the Reference Number and Key if the certification authority requires them.</p>
Enrollment Protocol	<p>Select the certification authority's enrollment protocol from the drop-down list box.</p> <p>Simple Certificate Enrollment Protocol (SCEP) is a TCP-based enrollment protocol that was developed by VeriSign and Cisco.</p> <p>Certificate Management Protocol (CMP) is a TCP-based enrollment protocol that was developed by the Public Key Infrastructure X.509 working group of the Internet Engineering Task Force (IETF) and is specified in RFC 2510.</p>
CA Server Address	Enter the IP address (or URL) of the certification authority server.
CA Certificate	<p>Select the certification authority's certificate from the CA Certificate drop-down list box.</p> <p>You must have the certification authority's certificate already imported in the Trusted CAs screen. Click Trusted CAs to go to the Trusted CAs screen where you can view (and manage) the ZyWALL's list of certificates of trusted certification authorities.</p>
Request Authentication	When you select Create a certification request and enroll for a certificate immediately online , the certification authority may want you to include a reference number and key to identify you when you send a certification request. Fill in both the Reference Number and the Key fields if your certification authority uses CMP enrollment protocol. Just fill in the Key field if your certification authority uses the SECP enrollment protocol.
Reference Number	Type the reference number that the certification authority gave you.
Key	Type the key that the certification authority gave you.
Apply	Click Apply to begin certificate or certification request generation.
Cancel	Click Cancel to quit and return to the My Certificates screen.

After you click **Apply** in the **My Certificate Create** screen, you see a screen that tells you the ZyWALL is generating the self-signed certificate or certification request.

After the ZyWALL successfully enrolls a certificate or generates a certification request or a self-signed certificate, you see a screen with a **Return** button that takes you back to the **My Certificates** screen.

If you configured the **My Certificate Create** screen to have the ZyWALL enroll a certificate and the certificate enrollment is not successful, you see a screen with a **return** button that takes you back to the **My Certificate Create** screen. Click **Return** and check your information in the **My Certificate Create** screen. Make sure that the certification authority information is correct and that your Internet connection is working properly if you want the ZyWALL to enroll a certificate online.

16.8 My Certificate Details

Click **CERTIFICATES**, and then **My Certificates** to open the **My Certificates** screen (see *Figure 16-2*). Select a certificate's radio button and click **Details** to open the **My Certificate Details** screen. You can use this screen to view in-depth certificate information and change the certificate's name. In the case of a self-signed certificate, you can set it to be the one that the ZyWALL uses to sign the trusted remote host certificates that you import to the ZyWALL.

CERTIFICATES - MY CERTIFICATE - DETAILS

Name

Property
 Default self-signed certificate which signs the imported remote host certificates.

Certification Path

Certificate Information

Type	Self-signed X.509 Certificate
Version	V3
Serial Number	946684801
Subject	CN=ZyWALL 10W
Issuer	CN=ZyWALL 10W
Signature Algorithm	rsa-pkcs1-sha1
Valid From	2000 Jan 1st, 00:00:00 GMT
Valid To	2030 Jan 1st, 00:00:00 GMT
Key Algorithm	rsaEncryption (512 bits)
Subject Alternative Name	EMAIL=replace.this@auto_generated.cert
Key Usage	DigitalSignature, KeyEncipherment, KeyCertSign
Basic Constraint	Subject Type=CA, Path Length Constraint=1
MD5 Fingerprint	68:f3:3e:af:42:06:c0:03:fa:98:64:b7:d1:22:f2:b2
SHA1 Fingerprint	98:d3:9e:b0:ee:d7:3a:ab:ba:a5:79:3a:fd:35:1b:de:a6:21:31:56

Certificate in PEM (Base-64) Encoded Format

```
-----BEGIN CERTIFICATE-----
MIIBcTCCARugAwIBAgIEOG1DgTANBgkqhkiG9w0BAQUFADAVMRMwEQYDVQQDEwp
aeVdBTEwgMTBXMjB4XDQwMDEwMTAwMDAwMFoXDQwMDEwMTAwMDAwMFoWFjETMB
EGA1UEAxMKWn1XQUxMIDEwVzBcMAOGCSqGSIb3DQEBAQUAA0sAMEgCQQDQdWHm9
AgcFbY1I1S91aCBb5VgaDDOpd0xdVkBBykLUhcsFnRTZ11+S61315WBxYKdvDjw
unCR1BhoXeaVgLvDAgMBAAGjUzBRMA4GA1UdDwEBAAQEAwICpDARBgNVHREEJDA
igSByZXBsYWN1LnRoZXNAYXV0by5nZW51cmFOZUwQuY2VydDAsBgNVHRMBAQECD
AGAQH/AgEBMAOGCSqGSIb3DQEBBQUAA0EArmXtbAC2KHdQ1e10qy5R04R1dcDU
hQ74TcSiE7WsyqAE2oJcH4DASUbmouu8Xg6IPhvcIPYx7VZfcgydcGLiW==
-----END CERTIFICATE-----
```

Figure 16-5 My Certificate Details

The following table describes the labels in this screen.

Table 16-4 My Certificate Details

LABEL	DESCRIPTION
Name	This field displays the identifying name of this certificate. If you want to change the name, type up to 31 characters to identify this certificate. You may use any character (not including spaces).
Property Default self-signed certificate which signs the imported remote host certificates.	<p>Select this check box to have the ZyWALL use this certificate to sign the trusted remote host certificates that you import to the ZyWALL. This check box is only available with self-signed certificates.</p> <p>If this check box is already selected, you cannot clear it in this screen, you must select this check box in another self-signed certificate's details screen. This automatically clears the check box in the details screen of the certificate that was previously set to sign the imported trusted remote host certificates.</p>
Certification Path	<p>Click the Refresh button to have this read-only text box display the hierarchy of certification authorities that validate the certificate (and the certificate itself).</p> <p>If the issuing certification authority is one that you have imported as a trusted certification authority, it may be the only certification authority in the list (along with the certificate itself). If the certificate is a self-signed certificate, the certificate itself is the only one in the list. The ZyWALL does not trust the certificate and displays "Not trusted" in this field if any certificate on the path has expired or been revoked.</p>
Refresh	Click Refresh to display the certification path.
Certificate Information	These read-only fields display detailed information about the certificate.
Type	This field displays general information about the certificate. "CA-signed" means that a Certification Authority signed the certificate. "Self-signed" means that the certificate's owner signed the certificate (not a certification authority). "X.509" means that this certificate was created and signed according to the ITU-T X.509 recommendation that defines the formats for public-key certificates.
Version	This field displays the X.509 version number.
Serial Number	This field displays the certificate's identification number given by the certification authority or generated by the ZyWALL.
Subject	This field displays information that identifies the owner of the certificate, such as Common Name (CN), Organizational Unit (OU), Organization (O) and Country (C).

Table 16-4 My Certificate Details

LABEL	DESCRIPTION
Issuer	<p>This field displays identifying information about the certificate's issuing certification authority, such as Common Name, Organizational Unit, Organization and Country.</p> <p>With self-signed certificates, this is the same as the Subject Name field.</p>
Signature Algorithm	<p>This field displays the type of algorithm that was used to sign the certificate. The ZyWALL uses rsa-pkcs1-sha1 (RSA public-private key encryption algorithm and the SHA1 hash algorithm). Some certification authorities may use ras-pkcs1-md5 (RSA public-private key encryption algorithm and the MD5 hash algorithm).</p>
Valid From	<p>This field displays the date that the certificate becomes applicable. The text displays in red and includes a "Not Yet Valid!" message if the certificate has not yet become applicable.</p>
Valid To	<p>This field displays the date that the certificate expires. The text displays in red and includes an "Expiring!" or "Expired!" message if the certificate is about to expire or has already expired.</p>
Key Algorithm	<p>This field displays the type of algorithm that was used to generate the certificate's key pair (the ZyWALL uses RSA encryption) and the length of the key set in bits (1024 bits for example).</p>
Subject Alternative Name	<p>This field displays the certificate owner's IP address (IP), domain name (DNS) or e-mail address (EMAIL).</p>
Key Usage	<p>This field displays for what functions the certificate's key can be used. For example, "DigitalSignature" means that the key can be used to sign certificates and "KeyEncipherment" means that the key can be used to encrypt text.</p>
Basic Constraint	<p>This field displays general information about the certificate. For example, "Subject Type=CA" means that this is a certification authority's certificate and "Path Length Constraint=1" means that there can only be one certification authority in the certificate's path.</p>
CRL Distribution Points	<p>This field displays how many directory servers with lists of revoked certificates the issuing certification authority of this certificate makes available. This field also displays the domain names or IP addresses of the servers.</p>
MD5 Fingerprint	<p>This is the certificate's message digest that the ZyWALL calculated using the MD5 algorithm.</p>
SHA1 Fingerprint	<p>This is the certificate's message digest that the ZyWALL calculated using the SHA1 algorithm.</p>

Table 16-4 My Certificate Details

LABEL	DESCRIPTION
Certificate in PEM (Base-64) Encoded Format	<p>This read-only text box displays the certificate or certification request in Privacy Enhanced Mail (PEM) format. PEM uses 64 ASCII characters to convert the binary certificate into a printable form.</p> <p>You can copy and paste a certification request into a certification authority's web page, an e-mail that you send to the certification authority or a text editor and save the file on a management computer for later manual enrollment.</p> <p>You can copy and paste a certificate into an e-mail to send to friends or colleagues or you can copy and paste a certificate into a text editor and save the file on a management computer for later distribution (via floppy disk for example).</p>
Export	Click this button and then Save in the File Download screen. The Save As screen opens, browse to the location that you want to use and click Save .
Apply	Click Apply to save your changes back to the ZyWALL. You can only change the name, except in the case of a self-signed certificate, which you can also set to be the default self-signed certificate that signs the imported trusted remote host certificates.
Cancel	Click Cancel to quit and return to the My Certificates screen.

16.9 Trusted CAs

Click **CERTIFICATES**, **Trusted CAs** to open the **Trusted CAs** screen. This screen displays a summary list of certificates of the certification authorities that you have set the ZyWALL to accept as trusted. The ZyWALL accepts any valid certificate signed by a certification authority on this list as being trustworthy; thus you do not need to import any certificate that is signed by one of these certification authorities. See the following figure.

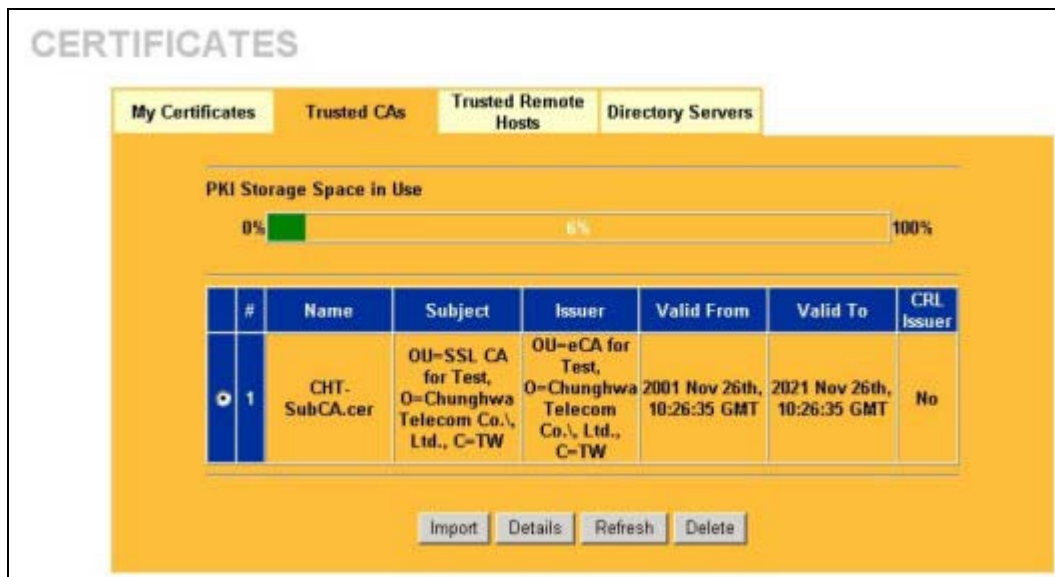

Figure 16-6 Trusted Cas

The following table describes the labels in this screen.

Table 16-5 Trusted CAs

LABEL	DESCRIPTION
PKI Storage Space in Use	This bar displays the percentage of the ZyWALL's PKI storage space that is currently in use. When you are using 80% or less of the storage space, the bar is green. When the amount of space used is over 80%, the bar is red. When the bar is red, you should consider deleting expired or unnecessary certificates before adding more certificates.
#	This field displays the certificate index number. The certificates are listed in alphabetical order.
Name	This field displays the name used to identify this certificate.
Subject	This field displays identifying information about the certificate's owner, such as CN (Common Name), OU (Organizational Unit or department), O (Organization or company) and C (Country). It is recommended that each certificate have unique subject information.

Table 16-5 Trusted CAs

LABEL	DESCRIPTION
Issuer	This field displays identifying information about the certificate's issuing certification authority, such as a common name, organizational unit or department, organization or company and country. With self-signed certificates, this is the same information as in the Subject field.
Valid From	This field displays the date that the certificate becomes applicable. The text displays in red and includes a "Not Yet Valid!" message if the certificate has not yet become applicable.
Valid To	This field displays the date that the certificate expires. The text displays in red and includes an "Expiring!" or "Expired!" message if the certificate is about to expire or has already expired.
CRL Issuer	This field displays "Yes" if the certification authority issues Certificate Revocation Lists for the certificates that it has issued and you have selected the Issues certificate revocation lists (CRL) check box in the certificate's details screen to have the ZyWALL check the CRL before trusting any certificates issued by the certification authority. Otherwise the field displays "No".
Import	Click Import to open a screen where you can save the certificate of a certification authority that you trust, from your computer to the ZyWALL.
Details	Select the radio button next to a certificate's index number and then click Details to open a screen with an in-depth list of information about that certificate.
Refresh	Click this button to display the current validity status of the certificates.
Delete	Select the radio button next to the index number of a certificate that you want to delete and then click Delete to remove that certificate.

16.10 Importing a Trusted CA's Certificate

Click **CERTIFICATES, Trusted CAs** to open the **Trusted CAs** screen and then click **Import** to open the **Trusted CA Import** screen. Follow the instructions in this screen to save a trusted certification authority's certificate to the ZyWALL, see the following figure.

You must remove any spaces from the certificate's filename before you can import it.]

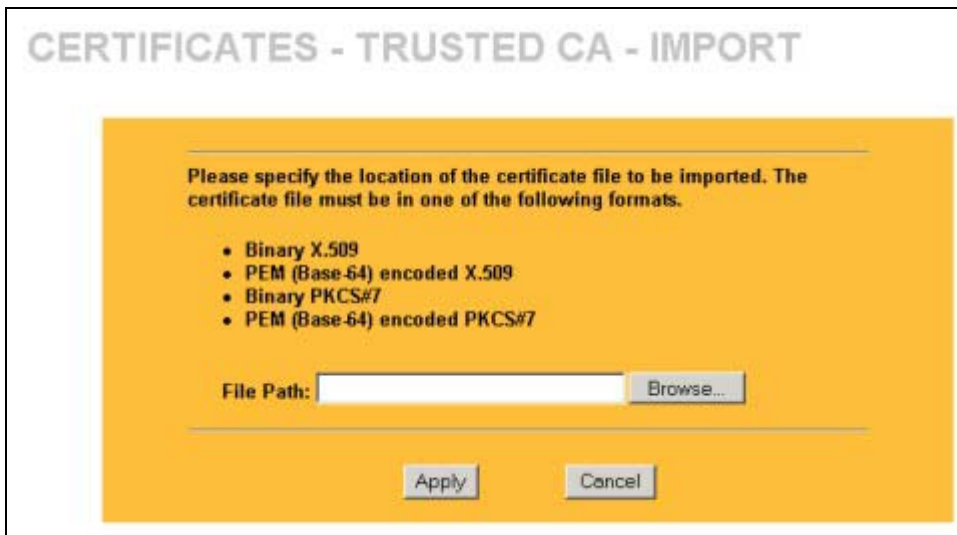

Figure 16-7 Trusted CA Import

The following table describes the labels in this screen.

Figure 16-8 Trusted CA Import

LABEL	DESCRIPTION
File Path	Type in the location of the file you want to upload in this field or click Browse to find it.
Browse	Click Browse to find the certificate file you want to upload.
Apply	Click Apply to save the certificate on the ZyWALL.
Cancel	Click Cancel to quit and return to the Trusted CAs screen.

16.11 Trusted CA Certificate Details

Click **CERTIFICATES**, **Trusted CAs** to open the **Trusted CAs** screen. Select a certificate's radio button and click **Details** to open the **Trusted CA Details** screen. Use this screen to view in-depth information about the certification authority's certificate, change the certificate's name and set whether or not you want the ZyWALL to check a certification authority's list of revoked certificates before trusting a certificate issued by the certification authority.

The following table describes the labels in this screen.

Table 16-6 Trusted CA Details

LABEL	DESCRIPTION
Name	This field displays the identifying name of this certificate. If you want to change the name, type up to 31 characters to identify this key certificate. You may use any character (not including spaces).
Property Check incoming certificates issued by this CA against a CRL	Select this check box to have the ZyWALL check incoming certificates that are issued by this certification authority against a Certificate Revocation List (CRL). Clear this check box to have the ZyWALL not check incoming certificates that are issued by this certification authority against a Certificate Revocation List (CRL).
Certification Path	Click the Refresh button to have this read-only text box display the end entity's certificate and a list of certification authority certificates that shows the hierarchy of certification authorities that validate the end entity's certificate. If the issuing certification authority is one that you have imported as a trusted certification authority, it may be the only certification authority in the list (along with the end entity's own certificate). The ZyWALL does not trust the end entity's certificate and displays "Not trusted" in this field if any certificate on the path has expired or been revoked.
Refresh	Click Refresh to display the certification path.
Certificate Information	These read-only fields display detailed information about the certificate.
Type	This field displays general information about the certificate. "CA-signed" means that a Certification Authority signed the certificate. "Self-signed" means that the certificate's owner signed the certificate (not a certification authority). "X.509" means that this certificate was created and signed according to the ITU-T X.509 recommendation that defines the formats for public-key certificates.
Version	This field displays the X.509 version number.
Serial Number	This field displays the certificate's identification number given by the certification authority.
Subject	This field displays information that identifies the owner of the certificate, such as Common Name (CN), Organizational Unit (OU), Organization (O) and Country (C).

Table 16-6 Trusted CA Details

LABEL	DESCRIPTION
Issuer	<p>This field displays identifying information about the certificate's issuing certification authority, such as Common Name, Organizational Unit, Organization and Country.</p> <p>With self-signed certificates, this is the same information as in the Subject Name field.</p>
Signature Algorithm	<p>This field displays the type of algorithm that was used to sign the certificate. Some certification authorities use rsa-pkcs1-sha1 (RSA public-private key encryption algorithm and the SHA1 hash algorithm). Other certification authorities may use ras-pkcs1-md5 (RSA public-private key encryption algorithm and the MD5 hash algorithm).</p>
Valid From	<p>This field displays the date that the certificate becomes applicable. The text displays in red and includes a "Not Yet Valid!" message if the certificate has not yet become applicable.</p>
Valid To	<p>This field displays the date that the certificate expires. The text displays in red and includes an "Expiring!" or "Expired!" message if the certificate is about to expire or has already expired.</p>
Key Algorithm	<p>This field displays the type of algorithm that was used to generate the certificate's key pair (the ZyWALL uses RSA encryption) and the length of the key set in bits (1024 bits for example).</p>
Subject Alternative Name	<p>This field displays the certificate's owner's IP address (IP), domain name (DNS) or e-mail address (EMAIL).</p>
Key Usage	<p>This field displays for what functions the certificate's key can be used. For example, "DigitalSignature" means that the key can be used to sign certificates and "KeyEncipherment" means that the key can be used to encrypt text.</p>
Basic Constraint	<p>This field displays general information about the certificate. For example, "Subject Type=CA" means that this is a certification authority's certificate and "Path Length Constraint=1" means that there can only be one certification authority in the certificate's path.</p>
CRL Distribution Points	<p>This field displays how many directory servers with Lists of revoked certificates the issuing certification authority of this certificate makes available. This field also displays the domain names or IP addresses of the servers.</p>
MD5 Fingerprint	<p>This is the certificate's message digest that the ZyWALL calculated using the MD5 algorithm. You can use this value to verify with the certification authority (over the phone for example) that this is actually their certificate.</p>

Table 16-6 Trusted CA Details

LABEL	DESCRIPTION
SHA1 Fingerprint	This is the certificate's message digest that the ZyWALL calculated using the SHA1 algorithm. You can use this value to verify with the certification authority (over the phone for example) that this is actually their certificate.
Certificate in PEM (Base-64) Encoded Format	This read-only text box displays the certificate or certification request in Privacy Enhanced Mail (PEM) format. PEM uses 64 ASCII characters to convert the binary certificate into a printable form. You can copy and paste the certificate into an e-mail to send to friends or colleagues or you can copy and paste the certificate into a text editor and save the file on a management computer for later distribution (via floppy disk for example).
Export	Click this button and then Save in the File Download screen. The Save As screen opens, browse to the location that you want to use and click Save .
Apply	Click Apply to save your changes back to the ZyWALL. You can only change the name and/or set whether or not you want the ZyWALL to check the CRL that the certification authority issues before trusting a certificate issued by the certification authority.
Cancel	Click Cancel to quit and return to the Trusted CAs screen.

16.12 Trusted Remote Hosts

Click **CERTIFICATES**, **Trusted Remote Hosts** to open the **Trusted Remote Hosts** screen (see the following figure). This screen displays a list of the certificates of peers that you trust but which are not signed by one of the certification authorities on the **Trusted CAs** screen.

You do not need to add any certificate that is signed by one of the certification authorities on the **Trusted CAs** screen since the ZyWALL automatically accepts any valid certificate signed by a trusted certification authority as being trustworthy.

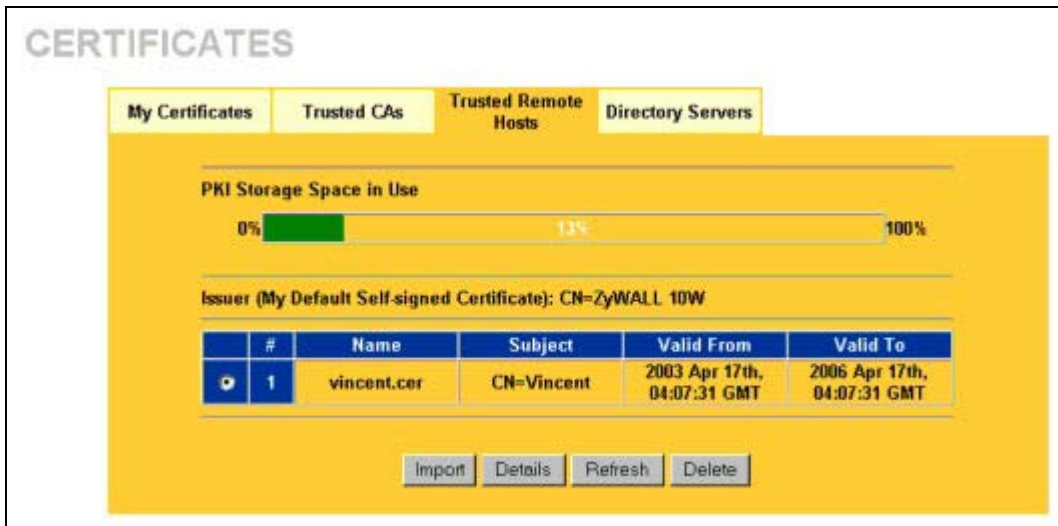

Figure 16-10 Trusted Remote Hosts

The following table describes the labels in this screen.

Table 16-7 Trusted Remote Hosts

LABEL	DESCRIPTION
PKI Storage Space in Use	This bar displays the percentage of the ZyWALL's PKI storage space that is currently in use. When you are using 80% or less of the storage space, the bar is green. When the amount of space used is over 80%, the bar is red. When the bar is red, you should consider deleting expired or unnecessary certificates before adding more certificates.
Issuer (My Default Self-signed Certificate)	This field displays identifying information about the default self-signed certificate on the ZyWALL that the ZyWALL uses to sign the trusted remote host certificates.
#	This field displays the certificate index number. The certificates are listed in alphabetical order.
Name	This field displays the name used to identify this certificate.
Subject	This field displays identifying information about the certificate's owner, such as CN (Common Name), OU (Organizational Unit or department), O (Organization or company) and C (Country). It is recommended that each certificate have unique subject information.

Table 16-7 Trusted Remote Hosts

LABEL	DESCRIPTION
Valid From	This field displays the date that the certificate becomes applicable. The text displays in red and includes a “Not Yet Valid!” message if the certificate has not yet become applicable.
Valid To	This field displays the date that the certificate expires. The text displays in red and includes an “Expiring!” or “Expired!” message if the certificate is about to expire or has already expired.
Import	Click Import to open a screen where you can save the certificate of a remote host (which you trust) from your computer to the ZyWALL.
Details	Select the radio button next to a certificate’s index number and then click Details to open a screen with an in-depth list of information about that certificate.
Refresh	Click this button to display the current validity status of the certificates.
Delete	Select the radio button next to the index number of a certificate that you want to delete and then click Delete to remove that certificate.

16.13 Verifying a Trusted Remote Host’s Certificate

Certificates issued by certification authorities have the certification authority’s signature for you to check. Self-signed certificates only have the signature of the host itself. This means that you must be very careful when deciding to import (and thereby trust) a remote host’s self-signed certificate.

16.13.1 Trusted Remote Host Certificate Fingerprints

A certificate’s fingerprints are message digests calculated using the MD5 or SHA1 algorithms. The following procedure describes how to use a certificate’s fingerprint to verify that you have the remote host’s actual certificate.

Step 1. Browse to where you have the remote host’s certificate saved on your computer.

Step 2. Make sure that the certificate has a “.cer” or “.crt” file name extension.

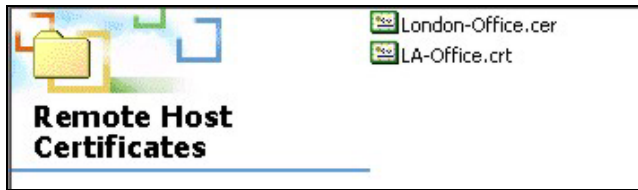

Figure 16-11 Remote Host Certificates

Step 3. Double-click the certificate's icon to open the **Certificate** window. Click the **Details** tab and scroll down to the **Thumbprint Algorithm** and **Thumbprint** fields.

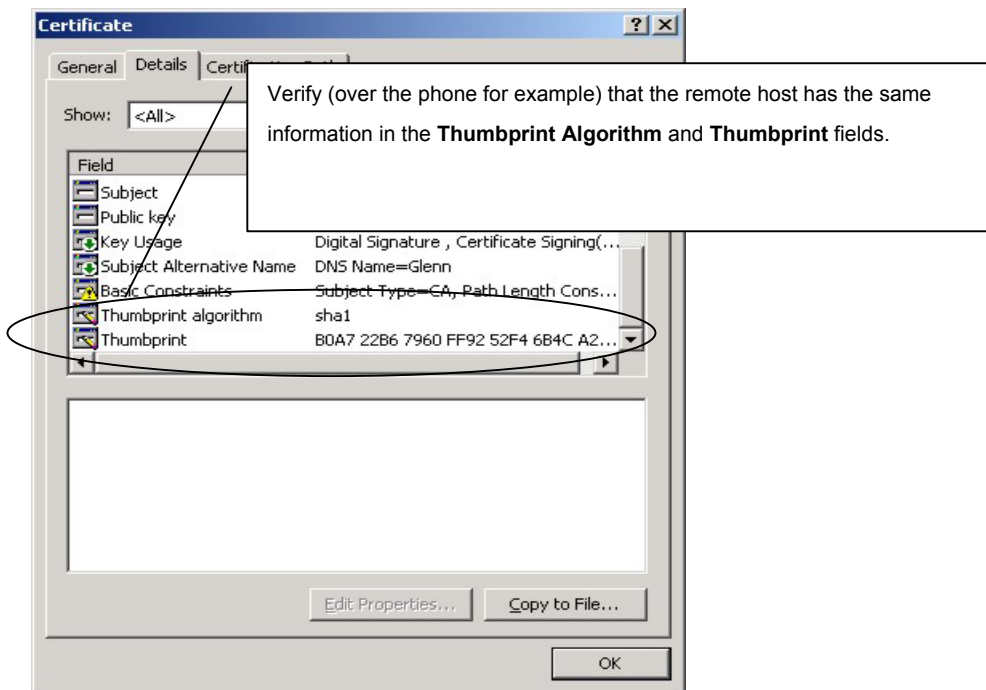

Figure 16-12 Certificate Details

16.14 Importing a Trusted Remote Host's Certificate

Click **CERTIFICATES**, **Trusted Remote Hosts** to open the **Trusted Remote Hosts** screen and then click **Import** to open the **Trusted Remote Host Import** screen. Follow the instructions in this screen to save a trusted host's certificate to the ZyWALL, see the following figure.

The trusted remote host certificate must be a self-signed certificate; and you must remove any spaces from its filename before you can import it.

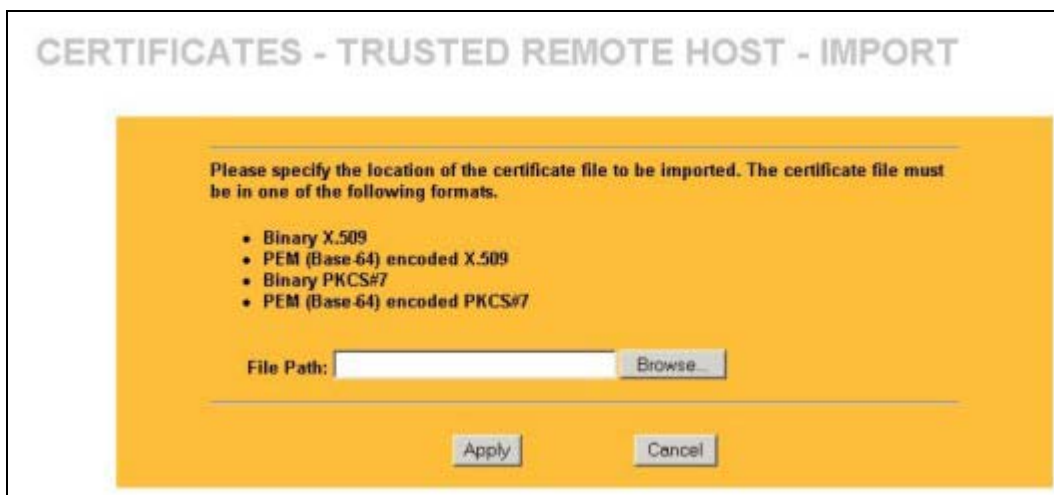

Figure 16-13 Trusted Remote Host Import

The following table describes the labels in this screen.

Table 16-8 Trusted Remote Host Import

LABEL	DESCRIPTION
File Path	Type in the location of the file you want to upload in this field or click Browse to find it.
Browse	Click Browse to find the certificate file you want to upload.
Apply	Click Apply to save the certificate on the ZyWALL.
Cancel	Click Cancel to quit and return to the Trusted Remote Hosts screen.

16.15 Trusted Remote Host Certificate Details

Click **CERTIFICATES**, **Trusted Remote Hosts** to open the **Trusted Remote Hosts** screen. Select a certificate's radio button and click **Details** to open the **Trusted Remote Host Details** screen. You can use this screen to view in-depth information about the trusted remote host's certificate and/or change the certificate's name.

CERTIFICATES - TRUSTED REMOTE HOST - DETAILS

Name

Certification Path

Certificate Information

Type	CA-signed X.509 Certificate
Version	V3
Serial Number	105063885153
Subject	CN=Vincent
Issuer	CN=ZyWALL 10W
Signature Algorithm	rsa-pkcs1-sha1
Valid From	2003 Apr 17th, 04:07:31 GMT
Valid To	2006 Apr 17th, 04:07:31 GMT
Key Algorithm	rsaEncryption (1024 bits)
Subject Alternative Name	DNS=Vincent
Key Usage	DigitalSignature
Basic Constraint	Path Length Constraint=10
MD5 Fingerprint	6b:30:8c:e9:20:f1:12:3b:fe:df:a2:42:b8:03:53:7b
SHA1 Fingerprint	e8:7c:58:19:cb:c8:17:db:bc:03:cd:4e:15:df:c2:9e:5d:66:76:69

Certificate in PEM (Base-64) Encoded Format

```
-----BEGIN CERTIFICATE-----
MIIB1zCCAUGgAwIBAgIFGHZLqWEwDQYJKoZIhvcNAQEFBQAoFTETMBEGA1UEAxM
KWn1XQUxMIDEwVzAeFw0wMzAOMTcwNDMzZmZlbnVjAOMTcwNDMzZmZlbnVjED
AOBgNVBAMTB1ZpbmN1bnQwZDQYJKoZIhvcNAQEBBQADgYOAMIGJAoGBAIOO2
zvdI/JtEVW5s6J6h88+0bpqq6qPCTWT82WqCvKny+iYsEpqtE5rwnLmmtNX1jY+
sA4qyQrBxA2vBfP3nPngSoshNvxgjOp6jK29zrsYz/cBCALQtu61HmoFWUprSx
ALG86Q28BwcjagUAGd44wVv1600iqFS2RSKgAadPAGMBAAGjNzA1MAsGA1UdDw
QEAwIChDASBgNVHREECzAJggdWaW5jZW50bG1Ga1UdEwEBAAQIMAYBAQACAQowD
QYJKoZIhvcNAQEFBQADQQA/VfrBOEymCJqFtZFWUORakhPoOaevr+rriR+0OZki
sCEFC6d06zj2Qb1AUyV/1kb1YVNI1hQ19JtJedbAVFN9
-----
```

Figure 16-14 Trusted Remote Host Details

The following table describes the labels in this screen.

Table 16-9 Trusted Remote Host Details

LABEL	DESCRIPTION
Name	This field displays the identifying name of this certificate. If you want to change the name, type up to 31 characters to identify this key certificate. You may use any character (not including spaces).
Certification Path	Click the Refresh button to have this read-only text box display the end entity's own certificate and a list of certification authority certificates in the hierarchy of certification authorities that validate a certificate's issuing certification authority. For a trusted host, the list consists of the end entity's own certificate and the default self-signed certificate that the ZyWALL uses to sign remote host certificates.
Refresh	Click Refresh to display the certification path.
Certificate Information	These read-only fields display detailed information about the certificate.
Type	This field displays general information about the certificate. With trusted remote host certificates, this field always displays "CA-signed". The ZyWALL is the Certification Authority that signed the certificate. "X.509" means that this certificate was created and signed according to the ITU-T X.509 recommendation that defines the formats for public-key certificates.
Version	This field displays the X.509 version number.
Serial Number	This field displays the certificate's identification number given by the device that created the certificate.
Subject	This field displays information that identifies the owner of the certificate, such as Common Name (CN), Organizational Unit (OU), Organization (O) and Country (C).
Issuer	This field displays identifying information about the default self-signed certificate on the ZyWALL that the ZyWALL uses to sign the trusted remote host certificates.
Signature Algorithm	This field displays the type of algorithm that the ZyWALL used to sign the certificate, which is rsa-pkcs1-sha1 (RSA public-private key encryption algorithm and the SHA1 hash algorithm).
Valid From	This field displays the date that the certificate becomes applicable. The text displays in red and includes a "Not Yet Valid!" message if the certificate has not yet become applicable.
Valid To	This field displays the date that the certificate expires. The text displays in red and includes an "Expiring!" or "Expired!" message if the certificate is about to expire or has already expired.

Table 16-9 Trusted Remote Host Details

LABEL	DESCRIPTION
Key Algorithm	This field displays the type of algorithm that was used to generate the certificate's key pair (the ZyWALL uses RSA encryption) and the length of the key set in bits (1024 bits for example).
Subject Alternative Name	This field displays the certificate's owner's IP address (IP), domain name (DNS) or e-mail address (EMAIL).
Key Usage	This field displays for what functions the certificate's key can be used. For example, "DigitalSignature" means that the key can be used to sign certificates and "KeyEncipherment" means that the key can be used to encrypt text.
Basic Constraint	This field displays general information about the certificate. For example, "Subject Type=CA" means that this is a certification authority's certificate and "Path Length Constraint=1" means that there can only be one certification authority in the certificate's path.
MD5 Fingerprint	This is the certificate's message digest that the ZyWALL calculated using the MD5 algorithm. You cannot use this value to verify that this is the remote host's actual certificate because the ZyWALL has signed the certificate; thus causing this value to be different from that of the remote hosts actual certificate. See <i>section 16.13.1</i> for how to verify a remote host's certificate.
SHA1 Fingerprint	This is the certificate's message digest that the ZyWALL calculated using the SHA1 algorithm. You cannot use this value to verify that this is the remote host's actual certificate because the ZyWALL has signed the certificate; thus causing this value to be different from that of the remote hosts actual certificate. See <i>section 16.13.1</i> for how to verify a remote host's certificate.
MD5 Fingerprint	This field displays the certificate's MD5 hash value. You can use this to verify that you and another individual are dealing with the same certificate.
SHA1 Fingerprint	This field displays the certificate's SHA1 hash value. You can use this to verify that you and another individual are dealing with the same certificate.
Certificate in PEM (Base-64) Encoded Format	<p>This read-only text box displays the certificate or certification request in Privacy Enhanced Mail (PEM) format. PEM uses 64 ASCII characters to convert the binary certificate into a printable form.</p> <p>You can copy and paste the certificate into an e-mail to send to friends or colleagues or you can copy and paste the certificate into a text editor and save the file on a management computer for later distribution (via floppy disk for example).</p>
Export	Click this button and then Save in the File Download screen. The Save As screen opens, browse to the location that you want to use and click Save .

Table 16-9 Trusted Remote Host Details

LABEL	DESCRIPTION
Apply	Click Apply to save your changes back to the ZyWALL. You can only change the name of the certificate.
Cancel	Click Cancel to quit configuring this screen and return to the Trusted Remote Hosts screen.

16.16 Directory Servers

Click **CERTIFICATES**, **Directory Servers** to open the **Directory Servers** screen. This screen displays a summary list of directory servers (that contain lists of valid and revoked certificates) that have been saved into the ZyWALL. If you decide to have the ZyWALL check incoming certificates against the issuing certification authority's list of revoked certificates, the ZyWALL first checks the server(s) listed in the **CRL Distribution Points** field of the incoming certificate. If the certificate does not list a server or the listed server is not available, the ZyWALL checks the servers listed here.

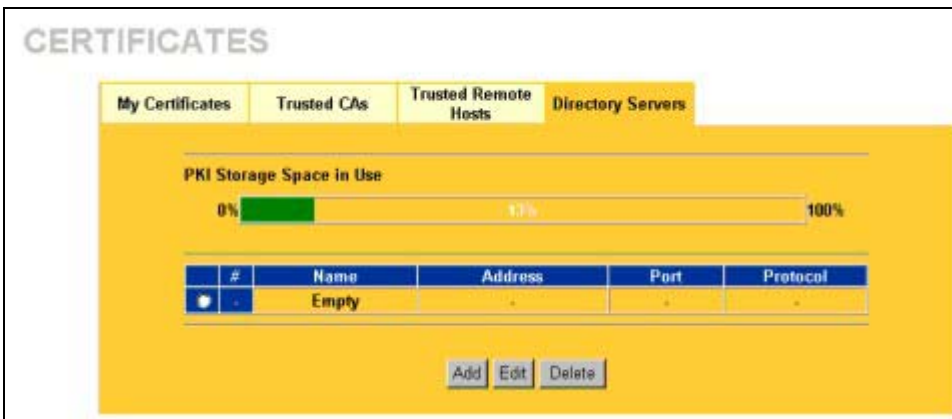
**Figure 16-15 Directory Servers**

The following table describes the labels in this screen.

Table 16-10 Directory Servers

LABEL	DESCRIPTION
PKI Storage Space in Use	This bar displays the percentage of the ZyWALL's PKI storage space that is currently in use. When you are using 80% or less of the storage space, the bar is green. When the amount of space used is over 80%, the bar is red. When the bar is red, you should consider deleting expired or unnecessary certificates before adding more certificates.
#	The index number of the directory server. The servers are listed in alphabetical order.
Name	This field displays the name used to identify this directory server.
Address	This field displays the IP address or domain name of the directory server.
Port	This field displays the port number that the directory server uses.
Protocol	This field displays the protocol that the directory server uses.
Add	Click Add to open a screen where you can configure information about a directory server so that the ZyWALL can access it.
Edit	Select the radio button next to a directory server's index number and then click Edit to open a screen where you can change the information about that directory server.
Delete	Select the radio button next to the index number of a directory server entry that you want to remove and then click Delete to remove that directory server entry.

16.17 Add or Edit a Directory Server

Click **CERTIFICATES, Directory Servers** to open the **Directory Servers** screen. Click **Add** (or **Edit**) to open the following screen. Use this screen to configure information about a directory server that the ZyWALL can access.

CERTIFICATES - DIRECTORY SERVER - ADD

Name

Access Protocol

Server Address

Server Port

Login

Password

Figure 16-16 Directory Server Add

The following table describes the labels in this screen.

Table 16-11 Directory Server Add

LABEL	DESCRIPTION
Name	Type up to 31 ASCII characters (spaces are not permitted) to identify this directory server.
Access Protocol	Use the drop-down list box to select the access protocol used by the directory server. LDAP (Lightweight Directory Access Protocol) is a protocol over TCP that specifies how clients access directories of certificates and lists of revoked certificates. ¹
Server Address	Type the IP address (in dotted decimal notation) or the domain name of the directory server.

¹ At the time of writing, LDAP is the only choice of directory server access protocol.

Table 16-11 Directory Server Add

LABEL	DESCRIPTION
Server Port	<p>This field displays the default server port number of the protocol that you select in the Access Protocol field.</p> <p>You may change the server port number if needed, however you must use the same server port number that the directory server uses.</p> <p>389 is the default server port number for LDAP.</p>
Login	<p>The ZyWALL may need to authenticate itself in order to assess the directory server. Type the login name (up to 31 ASCII characters) from the entity maintaining the directory server (usually a certification authority).</p>
Password	<p>Type the password (up to 31 ASCII characters) from the entity maintaining the directory server (usually a certification authority).</p>
Apply	<p>Click Apply to save your changes back to the ZyWALL.</p>
Cancel	<p>Click Cancel to quit configuring this screen and return to the Directory Servers screen.</p>

Part VIII:

Authentication Server, Remote Management and UPnP

This part provides information and configuration instructions for configuration of the authentication server screens, remote management and Universal Plug and Play.

Chapter 17

Authentication Server

This chapter discusses how to configure the authentication server on the ZyWALL.

17.1 Authentication Server Overview

A ZyWALL set to be a VPN extended authentication server can use either the local user database internal to the ZyWALL or an external RADIUS server for an unlimited number of users. The ZyWALL uses the same local user database for VPN extended authentication and wireless LAN security (see the VPN and wireless LAN chapters).

17.2 Local User Database

By storing user profiles locally on the ZyWALL, your ZyWALL is able to authenticate VPN extended authentication clients or wireless clients without interacting with a network RADIUS server. However, there is a limit on the number of users you may authenticate in this way.

17.3 Configuring Local User Database

To change your ZyWALL's local user list, click **AUTH SERVER**, then the **Local User Database** tab. The screen appears as shown.

AUTH SERVER

Local User Database RADIUS

#	Active	User Name	Password
1	<input type="checkbox"/>		
2	<input type="checkbox"/>		
3	<input type="checkbox"/>		
4	<input type="checkbox"/>		
5	<input type="checkbox"/>		
6	<input type="checkbox"/>		
7	<input type="checkbox"/>		
8	<input type="checkbox"/>		
9	<input type="checkbox"/>		
10	<input type="checkbox"/>		
11	<input type="checkbox"/>		
12	<input type="checkbox"/>		
13	<input type="checkbox"/>		
14	<input type="checkbox"/>		
15	<input type="checkbox"/>		
16	<input type="checkbox"/>		
17	<input type="checkbox"/>		
18	<input type="checkbox"/>		
19	<input type="checkbox"/>		
20	<input type="checkbox"/>		
21	<input type="checkbox"/>		
22	<input type="checkbox"/>		
23	<input type="checkbox"/>		
24	<input type="checkbox"/>		
25	<input type="checkbox"/>		
26	<input type="checkbox"/>		
27	<input type="checkbox"/>		
28	<input type="checkbox"/>		
29	<input type="checkbox"/>		
30	<input type="checkbox"/>		
31	<input type="checkbox"/>		
32	<input type="checkbox"/>		

Apply Reset

Figure 17-1 Local User Database

The following table describes the labels in this screen.

Table 17-1 Local User Database

LABEL	DESCRIPTION
Active	Select this check box to enable the user profile.
User Name	Enter the user name of the user profile.
Password	Enter a password up to 31 characters long for this user profile.
Apply	Click Apply to save your changes back to the ZyWALL.
Reset	Click Reset to begin configuring this screen afresh.

17.3.1 RADIUS

RADIUS is based on a client-server model that supports authentication and accounting, where access point is the client and the server is the RADIUS server. The RADIUS server handles the following tasks among others:

- **Authentication**

Determines the identity of the users.

- **Accounting**

Keeps track of the client's network activity.

RADIUS user is a simple package exchange in which your ZyWALL acts as a message relay between the wireless client and the network RADIUS server.

Types of RADIUS Messages

The following types of RADIUS messages are exchanged between the access point and the RADIUS server for user authentication:

- **Access-Request**

Sent by the ZyWALL requesting authentication.

- **Access-Reject**

Sent by a RADIUS server rejecting access.

- **Access-Accept**

Sent by a RADIUS server allowing access.

- **Access-Challenge**

Sent by a RADIUS server requesting more information in order to allow access. The access point sends a proper response from the user and then sends another Access-Request message.

The following types of RADIUS messages are exchanged between the access point and the RADIUS server for user accounting:

- **Accounting-Request**

Sent by the ZyWALL requesting accounting.

- **Accounting-Response**

Sent by the RADIUS server to indicate that it has started or stopped accounting.

In order to ensure network security, the ZyWALL and the RADIUS server use a shared secret key, which is a password, they both know. The key is not sent over the network. In addition to the shared key, password information exchanged is also encrypted to protect the network from unauthorized access.

17.3.2 EAP Authentication Overview

EAP (Extensible Authentication Protocol) is an authentication protocol that runs on top of the IEEE802.1x transport mechanism in order to support multiple types of user authentication. By using EAP to interact with an EAP-compatible RADIUS server, the access point helps a wireless station and a RADIUS server perform authentication.

The type of authentication you use depends on the RADIUS server or the AP. The ZyWALL supports EAP-TLS and EAP-TTLS with RADIUS. Refer to the *Types of EAP Authentication* appendix for descriptions.

Your ZyWALL supports EAP-MD5 (Message-Digest Algorithm 5) with the local user database.

The following figure shows an overview of authentication when you specify a RADIUS server on your access point.

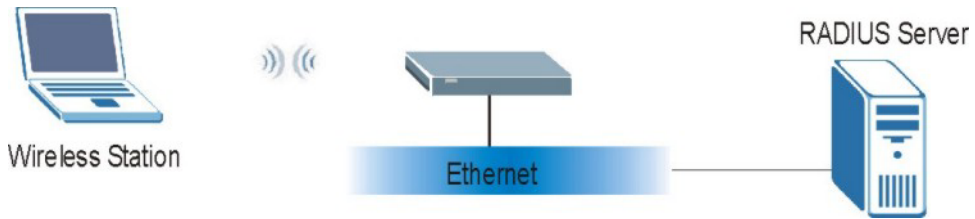

Figure 17-2 EAP Authentication

The details below provide a general description of how IEEE 802.1x EAP authentication works. For an example list of EAP-MD5 authentication steps, see the IEEE 802.1x chapter in the *Appendices*.

- The wireless station sends a “start” message to the ZyWALL.
- The ZyWALL sends a “request identity” message to the wireless station for identity information.
- The wireless station replies with identity information, including username and password.
- The RADIUS server checks the user information against its user profile database and determines whether or not to authenticate the wireless station.

17.4 Configuring RADIUS

Use the **RADIUS** screen if you want to use an external server to perform authentication.

When you use a RADIUS sever for VPN extended authentication, you must configure the RADIUS server to use the MD5-Challenge authentication algorithm.

To set up your ZyWALL’s RADIUS server settings, click **AUTH SERVER**, then the **RADIUS** tab. The screen appears as shown.

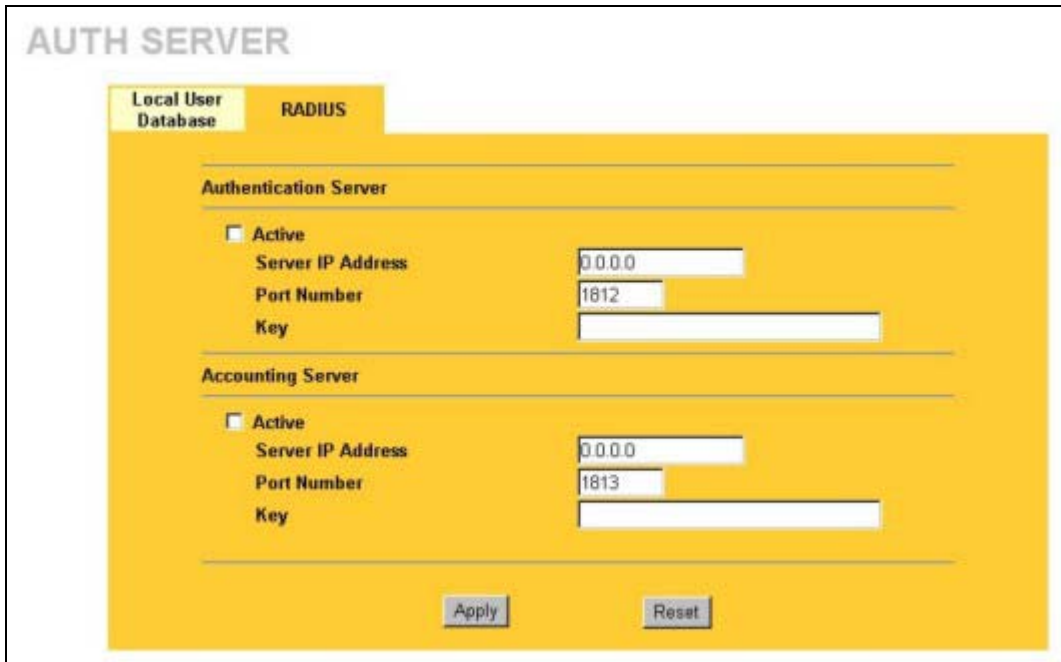

Figure 17-3 RADIUS

The following table describes the labels in this screen.

Table 17-2 RADIUS

LABEL	DESCRIPTION
Authentication Server	
Active	<p>Enable this feature to have the ZyWALL use an external authentication server in performing user authentication.</p> <p>Disable this feature if you will not use an external authentication server. If you disable this feature, you can still set the ZyWALL to perform user authentication using the local user database.</p>
Server Address	<p>Enter the IP address of the external authentication server in dotted decimal notation.</p>

Table 17-2 RADIUS

LABEL	DESCRIPTION
Port Number	<p>The default port of the RADIUS server for authentication is 1812.</p> <p>You need not change this value unless your network administrator instructs you to do so with additional information.</p>
Key	<p>Enter a password (up to 31 alphanumeric characters) as the key to be shared between the external authentication server and the access points.</p> <p>The key is not sent over the network. This key must be the same on the external authentication server and ZyWALL.</p>
Accounting Server	
Active	<p>Enable this feature to do user accounting through an external authentication server.</p>
Server Address	<p>Enter the IP address of the external accounting server in dotted decimal notation.</p>
Port Number	<p>The default port of the RADIUS server for accounting is 1813.</p> <p>You need not change this value unless your network administrator instructs you to do so with additional information.</p>
Key	<p>Enter a password (up to 31 alphanumeric characters) as the key to be shared between the external accounting server and the access points.</p> <p>The key is not sent over the network. This key must be the same on the external accounting server and ZyWALL.</p>
Apply	<p>Click Apply to save your changes back to the ZyWALL.</p>
Reset	<p>Click Reset to begin configuring this screen afresh.</p>

Chapter 18

Remote Management Screens

This chapter provides information on the Remote Management screens.

18.1 Remote Management Overview

Remote management allows you to determine which services/protocols can access which ZyWALL interface (if any) from which computers.

When you configure remote management to allow management from the WAN, you still need to configure a firewall rule to allow access. See the firewall chapters for details on configuring firewall rules.

You may manage your ZyWALL from a remote location via:

- Internet (WAN only)
- ALL (LAN and WAN)
- LAN only,
- Neither (Disable).

When you Choose WAN only or ALL (LAN & WAN), you still need to configure a firewall rule to allow access.

To disable remote management of a service, select **Disable** in the corresponding **Server Access** field.

You may only have one remote management session running at a time. The ZyWALL automatically disconnects a remote management session of lower priority when another remote management session of higher priority starts. The priorities for the different types of remote management sessions are as follows.

1. Console port
2. SSH
3. Telnet
4. HTTPS and HTTP

18.1.1 Remote Management Limitations

Remote management over LAN or WAN will not work when:

1. A filter in SMT menu 3.1 (LAN) or in menu 11.5 (WAN) is applied to block a Telnet, FTP or Web service.
2. You have disabled that service in one of the remote management screens.
3. The IP address in the **Secure Client IP** field does not match the client IP address. If it does not match, the ZyWALL will disconnect the session immediately.
4. There is already another remote management session with an equal or higher priority running. You may only have one remote management session running at one time.
5. There is a firewall rule that blocks it.

18.1.2 Remote Management and NAT

When NAT is enabled:

- Use the ZyWALL's WAN IP address when configuring from the WAN.
- Use the ZyWALL's LAN IP address when configuring from the LAN.

18.1.3 System Timeout

There is a default system timeout of five minutes (three hundred seconds) for either the console port or telnet/web/FTP connections. Your ZyWALL automatically logs you out if you do nothing in this timeout period, except when it is continuously updating the status in menu 24.1. See the **System** screen to change the timeout period in the **Administrator Inactivity Timer** field or use the `sys studio` command.

18.2 Introduction to HTTPS

HTTPS (HyperText Transfer Protocol over Secure Socket Layer, or HTTP over SSL) is a web protocol that encrypts and decrypts web sessions. Secure Socket Layer (SSL) is an application-level protocol that enables secure transactions of data by ensuring confidentiality (an unauthorized party cannot read the transferred

data), authentication (one party can identify the other party) and data integrity (you know if data has been changed).

It relies upon certificates, public keys, and private keys (see the *Certificates chapter* for more information).

HTTPS on the ZyWALL is used so that you may securely access the ZyWALL using the web configurator. The SSL protocol specifies that the SSL server (the ZyWALL) must always authenticate itself to the SSL client (the computer which requests the HTTPS connection with the ZyWALL), whereas the SSL client only should authenticate itself when the SSL server requires it to do so (select **Authenticate Client Certificates** in the **Remote Mngt, WWW** screen). **Authenticate Client Certificates** is optional and if selected means the SSL-client must send the ZyWALL a certificate. You must apply for a certificate for the browser from a CA that is a trusted CA on the ZyWALL.

Please refer to the following figure.

1. HTTPS connection requests from an SSL-aware web browser go to port 443 (by default) on the ZyWALL's WS (web server).
2. HTTP connection requests from a web browser go to port 80 (by default) on the ZyWALL's WS (web server).

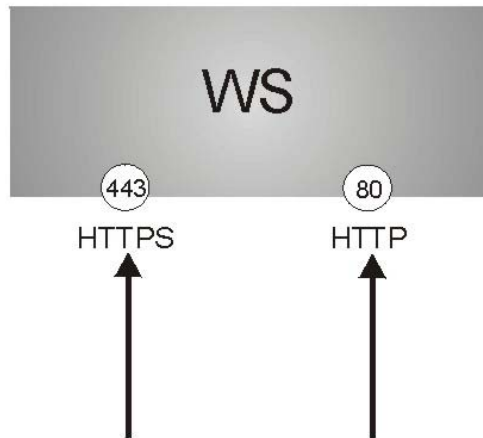

Figure 18-1 HTTPS Implementation

If you disable HTTP Server Access (Disable) in the REMOTE MGNT WWW screen, then the ZyWALL blocks all HTTP connection attempts.

18.3 Configuring WWW

To change your ZyWALL's World Wide Web settings, click **REMOTE MANAGEMENT**, then the **WWW** tab. The screen appears as shown.

Figure 18-2 WWW

The following table describes the labels in this screen.

Table 18-1 WWW

LABEL	DESCRIPTION
HTTPS	

Table 18-1 WWW

LABEL	DESCRIPTION
Server Certificate	Select the Server Certificate that the ZyWALL will use to identify itself. The ZyWALL is the SSL server and must always authenticate itself to the SSL client (the computer which requests the HTTPS connection with the ZyWALL).
Authenticate Client Certificates	Select Authenticate Client Certificates (optional) to require the SSL client to authenticate itself to the ZyWALL by sending the ZyWALL a certificate. To do that the SSL client must have a CA-signed certificate from a CA that has been imported as a trusted CA on the ZyWALL (see the appendix on importing certificates for details).
Server Port	The HTTPS server listens on port 443 by default. If you change the HTTPS server port to a different number on the ZyWALL, for example 8443, then you must notify people who need to access the ZyWALL web configurator to use "https://ZyWALL IP Address:8443" as the URL.
Server Access	Select a ZyWALL interface from Server Access on which incoming HTTPS access is allowed. You can allow only secure web configurator access by setting the HTTP Server Access field to Disable and setting the HTTPS Server Access field to an interface(s).
Secure Client IP Address	A secure client is a "trusted" computer that is allowed to communicate with the ZyWALL using this service. Select All to allow any computer to access the ZyWALL using this service. Choose Selected to just allow the computer with the IP address that you specify to access the ZyWALL using this service.
HTTP	
Server Port	You may change the server port number for a service if needed, however you must use the same port number in order to use that service for remote management.
Server Access	Select the interface(s) through which a computer may access the ZyWALL using this service.
Secure Client IP Address	A secure client is a "trusted" computer that is allowed to communicate with the ZyWALL using this service. Select All to allow any computer to access the ZyWALL using this service. Choose Selected to just allow the computer with the IP address that you specify to access the ZyWALL using this service.
Apply	Click Apply to save your customized settings and exit this screen.
Reset	Click Reset to begin configuring this screen afresh.

18.4 HTTPS Login Example

If you haven't changed the default HTTPS port on the ZyWALL, then in your browser enter "https://ZyWALL IP Address/" as the web site address where "ZyWALL IP Address" is the IP address or domain name of the ZyWALL you wish to access.

18.4.1 Internet Explorer Warning Messages

When you attempt to access the ZyWALL HTTPS server, a Windows dialog box pops up asking if you trust the server certificate. Click **View Certificate** if you want to verify that the certificate is from the ZyWALL.

You see the following **Security Alert** screen in Internet Explorer. Select **Yes** to proceed to the web configurator login screen; if you select **No**, then web configurator access is blocked.



Figure 18-3 Security Alert Dialog Box (Internet Explorer)

18.4.2 Netscape Navigator Warning Messages

When you attempt to access the ZyWALL HTTPS server, a **Website Certified by an Unknown Authority** screen pops up asking if you trust the server certificate. Click **Examine Certificate** if you want to verify that the certificate is from the ZyWALL.

If **Accept this certificate temporarily for this session** is selected, then click **OK** to continue in Netscape.

Select **Accept this certificate permanently** to import the ZyWALL's certificate into the SSL client.



Figure 18-4 Security Certificate Example (Netscape)



Figure 18-5 Security Certificate 2 Example (Netscape)

18.4.3 Avoiding the Browser Warning Messages

The following describes the main reasons that your browser displays warnings about the ZyWALL's HTTPS server certificate and what you can do to avoid seeing the warnings.

- The issuing certificate authority of the ZyWALL's HTTPS server certificate is not one of the browser's trusted certificate authorities. The issuing certificate authority of the ZyWALL's factory default certificate is the ZyWALL itself since the certificate is a self-signed certificate.
 - For the browser to trust a self-signed certificate, import the self-signed certificate into your operating system as a trusted certificate.
 - To have the browser trust the certificates issued by a certificate authority, import the certificate authority's certificate into your operating system as a trusted certificate. Refer to the appendix on importing certificates for details.
- The actual IP address of the HTTPS server (the IP address of the ZyWALL's port that you are trying to access) does not match the common name specified in the ZyWALL's HTTPS server certificate that your browser received. Do the following to check the common name specified in the certificate that your ZyWALL sends to HTTPS clients.

- Step 1.** Click **REMOTE MGNT** and then **WWW**. Write down the name of the certificate displayed in the **Server Certificate** field.
- Step 2.** Click **CERTIFICATES, My Certificates**. Find the certificate and check its **Subject** column. **CN** stands for certificate's common name (see *Figure 18-9* for an example).

Use this procedure to have the ZyWALL use a certificate with a common name that matches the ZyWALL's actual IP address. You cannot use this procedure if you need to access the WAN port and it uses a dynamically assigned IP address.

- Step 1.** Create a new certificate for the ZyWALL that uses the IP address (of the ZyWALL's port that you are trying to access) as the certificate's common name. For example, to use HTTPS to access a LAN port with IP address 192.168.1.1, create a certificate that uses 192.168.1.1 as the common name.
- Step 2.** Go to the remote management **WWW** screen and select the newly created certificate in the **Server Certificate** field. Click **Apply**.

18.4.4 Login Screen

After you accept the certificate, the ZyWALL login screen appears. The lock displayed in the bottom right of the browser status bar denotes a secure connection.



Figure 18-6 Login Screen Example (Internet Explorer)



Figure 18-7 Login Screen Example (Netscape)

Click **Login** and you then see the next screen.

The factory default certificate is a common default certificate for all ZyWALL models.

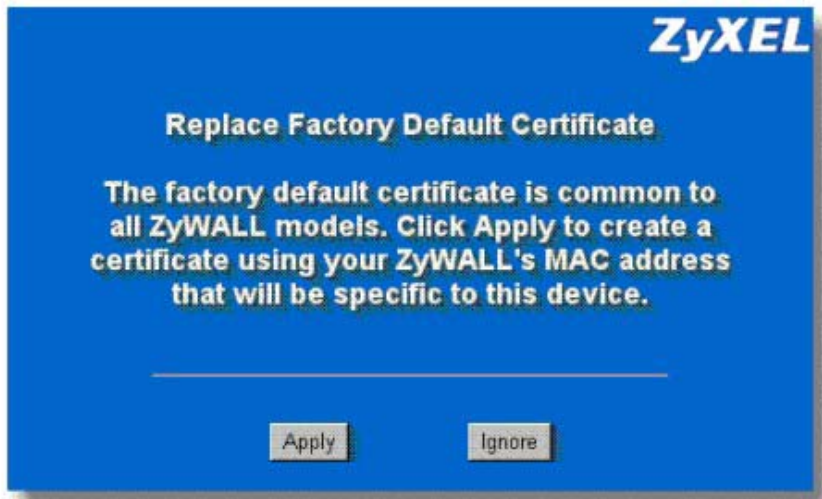



Figure 18-8 Replace Certificate

Click **Apply** in the **Replace Certificate** screen to create a certificate using your ZyWALL's MAC address that will be specific to this device. Click **CERTIFICATES**, **My Certificates** to open the **My Certificates** screen. You will see information similar to that shown in the following figure.

CERTIFICATES

My Certificates Trusted CAs Trusted Remote Hosts Directory Servers

PKI Storage Space in Use

0%  100%

ID	Name	Type	Subject	Issuer	Valid From	Valid To
1	auto_generated_self_signed_cert	SELF	CN=ZyWALL 10W 00A0C5434670	CN=ZyWALL 10W 00A0C5434670	2000 Jan 1st, 00:00:00 GMT	2030 Jan 1st, 00:00:00 GMT

Import Create Details Refresh Delete

Figure 18-9 Device-specific Certificate

Click **Ignore** in the **Replace Certificate** screen to use the common ZyWALL certificate. You will then see this information in the **My Certificates** screen.

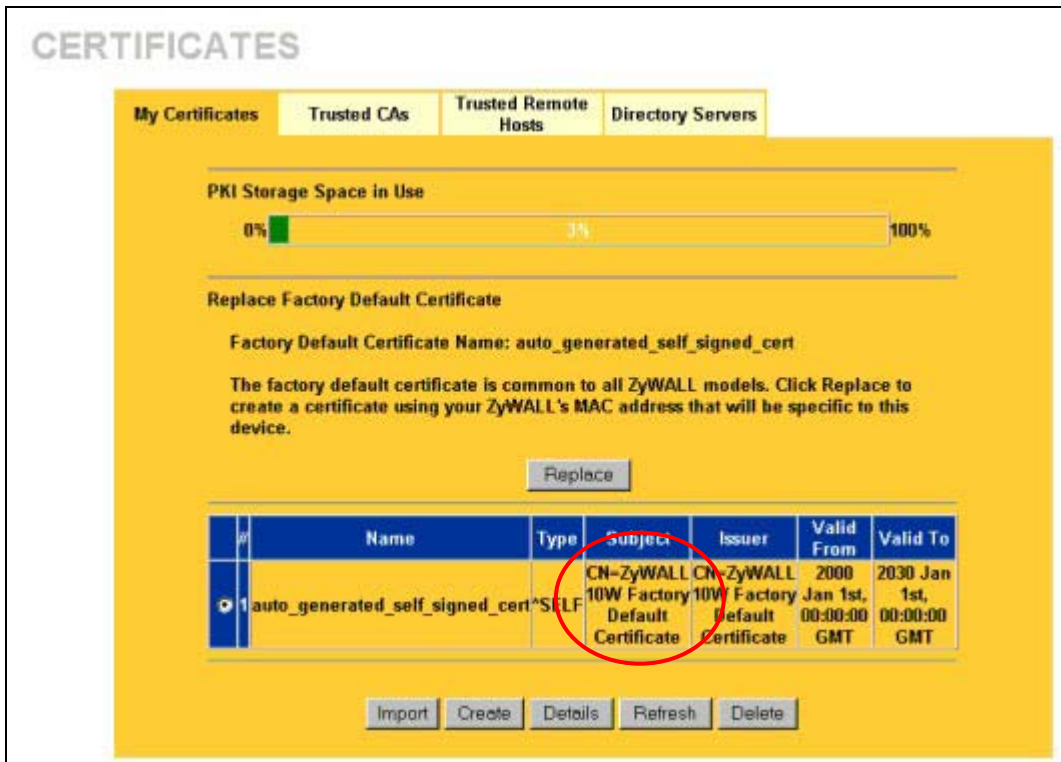

Figure 18-10 Common ZyWALL Certificate

18.5 SSH Overview

Unlike Telnet or FTP, which transmit data in clear text, SSH (Secure Shell) is a secure communication protocol that combines authentication and data encryption to provide secure encrypted communication between two hosts over an unsecured network.



Figure 18-11 SSH Communication Example

18.6 How SSH works

The following table summarizes how a secure connection is established between two remote hosts.

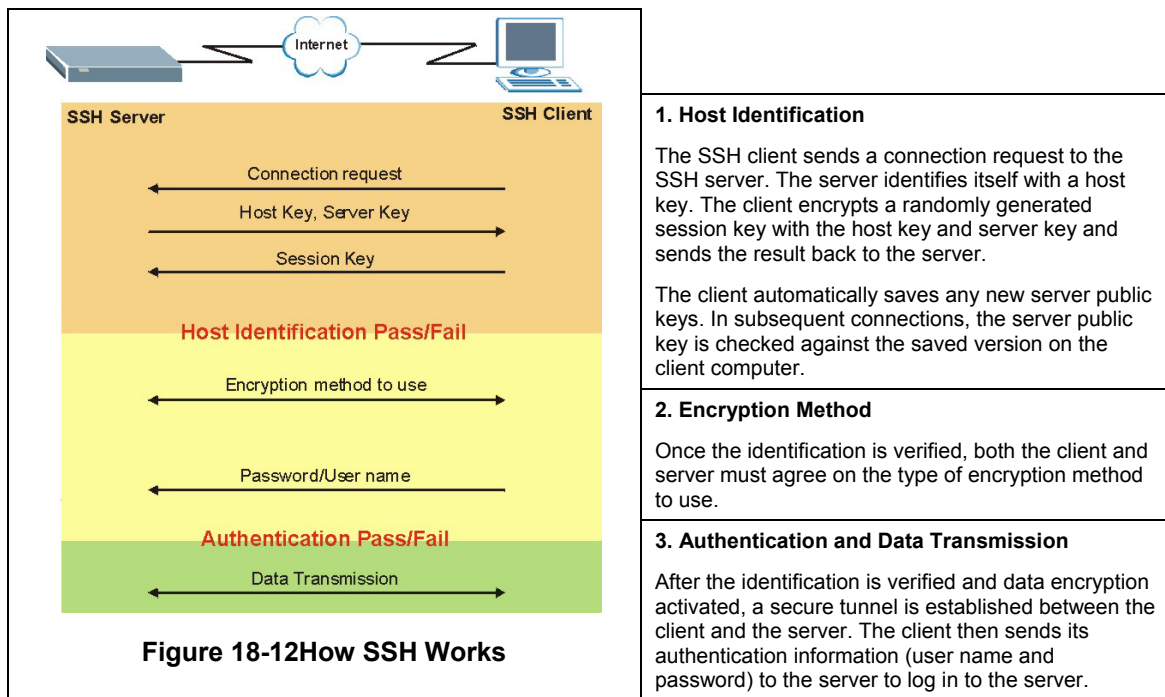

Figure 18-12How SSH Works

18.7 SSH Implementation on the ZyWALL

Your ZyWALL supports SSH version 1.5 using RSA authentication and three encryption methods (DES, 3DES and Blowfish). The SSH server is implemented on the ZyWALL for remote SMT management and file transfer on port 22. Only one SSH connection is allowed at a time.

18.7.1 Requirements for Using SSH

You must install an SSH client program on a client computer (Windows or Linux operating system) that is used to connect to the ZyWALL over SSH.

18.8 Configuring SSH

Click **Remote Management** and then the **SSH** tab. The screen displays as shown.

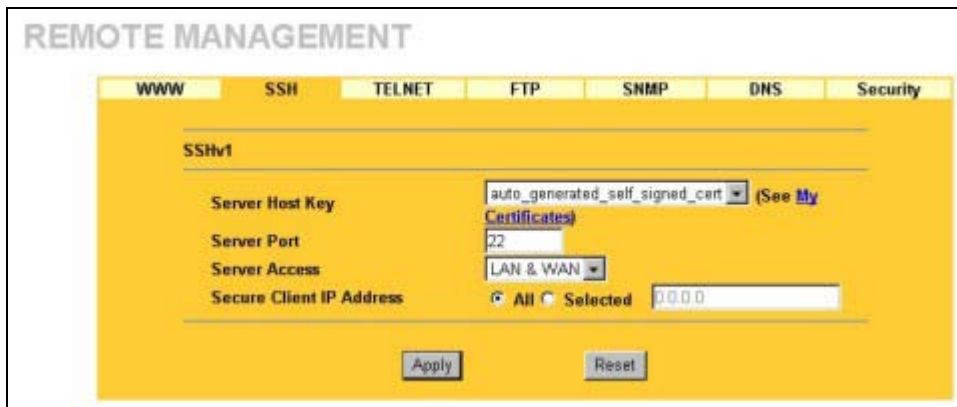

Figure 18-13 Remote Management: SSH

The following table describes the labels in this screen.

Table 18-2 SSH

LABEL	DESCRIPTION	EXAMPLE
Server Host Key	Select the certificate whose corresponding private key is to be used to identify the ZyWALL for SSH connections. You must have certificates already configured in the My Certificates screen (Click My Certificates and see the <i>Certificates</i> part for details).	
Server Port	You may change the server port number for a service if needed, however you must use the same port number in order to use that service for remote management.	22
Server Access	Define the rule for server access by selecting from the drop-down menu. Options are LAN , WAN , LAN&WAN or Disable .	LAN & WAN
Secure Client IP Address	A secure client is a “trusted” computer that is allowed to communicate with the ZyWALL using SSH. Select Selected or All . If you select Selected you must enter an IP address in the field provided. The ZyWALL will check if the client IP address matches the value here when an SSH session is up. If it does not match, the ZyWALL will disconnect the session immediately. Select All if you want to allow computers with any IP address to access the ZyWALL's SSH server.	0.0.0.0
Apply	Click Apply to save your settings.	
Reset	Click Reset to begin configuring this screen afresh.	

It is recommended you disable Telnet and FTP when you configure SSH for secure connection.

18.9 Secure Telnet Using SSH Examples

This section shows two examples using a command interface and a graphical interface SSH client program to remotely access the ZyWALL. The configuration and connection steps are similar for most SSH client programs. Refer to your SSH client program user’s guide.

18.9.1 Example 1: Microsoft Windows

This section describes how to access the ZyWALL using the Secure Shell Client program.

- Step 3.** Launch the SSH client and specify the connection information (IP address, port number or device name) for the ZyWALL.
- Step 4.** Configure the SSH client to accept connection using SSH version 1.
- Step 5.** A window displays prompting you to store the host key in you computer. Click **Yes** to continue.



Figure 18-14 SSH Example 1: Store Host Key

- Step 6.** Enter the password to log in to the ZyWALL. The SMT main menu displays next.

18.9.2 Example 2: Linux

This section describes how to access the ZyWALL using the OpenSSH client program that comes with most Linux distributions.

- Step 1.** Test whether the SSH service is available on the ZyWALL.
Enter “telnet 192.168.1.1 22” at a terminal prompt and press [ENTER]. The computer attempts to connect to port 22 on the ZyWALL (using the default IP address of 192.168.1.1). A message displays indicating the SSH protocol version supported by the ZyWALL.

```
$ telnet 192.168.1.1 22
Trying 192.168.1.1...
Connected to 192.168.1.1.
Escape character is '^]'.
SSH-1.5-1.0.0
```

Figure 18-15 SSH Example 2: Test

Step 2. Enter “ssh -1 192.168.1.1”. This command forces your computer to connect to the ZyWALL using SSH version 1. If this is the first time you are connecting to the ZyWALL using SSH, a message displays prompting you to save the host information of the ZyWALL. Type “yes” and press [ENTER].

Then enter the password to log in to the ZyWALL.

```
$ ssh -1 192.168.1.1
The authenticity of host '192.168.1.1 (192.168.1.1)' can't be established.
RSA1 key fingerprint is 21:6c:07:25:7e:f4:75:80:ec:af:bd:d4:3d:80:53:d1.
Are you sure you want to continue connecting (yes/no)? yes
Warning: Permanently added '192.168.1.1' (RSA1) to the list of known hosts.
Administrator@192.168.1.1's password:
```

Figure 18-16 SSH Example 2: Log in

Step 3. The SMT main menu displays next.

18.10 Secure FTP Using SSH Example

This section shows an example on file transfer using the OpenSSH client program. The configuration and connection steps are similar for other SSH client programs. Refer to your SSH client program user’s guide.

Step 1. Enter “sftp -1 192.168.1.1”. This command forces your computer to connect to the ZyWALL for secure file transfer using SSH version 1. If this is the first time you are connecting to the ZyWALL using SSH, a message displays prompting you to save the host information of the ZyWALL. Type “yes” and press [ENTER].

Step 2. Enter the password to login to the ZyWALL.

Step 3. Use the “put” command to upload a new firmware to the ZyWALL.

```
$ sftp -l 192.168.1.1
Connecting to 192.168.1.1...
The authenticity of host '192.168.1.1 (192.168.1.1)' can't be established.
RSA1 key fingerprint is 21:6c:07:25:7e:f4:75:80:ec:af:bd:d4:3d:80:53:d1.
Are you sure you want to continue connecting (yes/no)? yes
Warning: Permanently added '192.168.1.1' (RSA1) to the list of known hosts.
Administrator@192.168.1.1's password:
sftp> put firmware.bin ras
Uploading firmware.bin to /ras
Read from remote host 192.168.1.1: Connection reset by peer
Connection closed
$
```

Figure 18-17 Secure FTP: Firmware Upload Example

18.11 Telnet

You can configure your ZyWALL for remote Telnet access as shown next. The administrator uses Telnet from a computer on a remote network to access the ZyWALL.

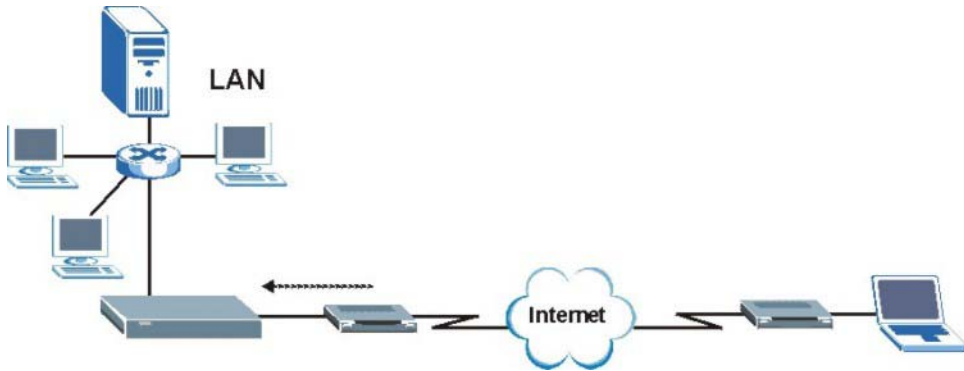

Figure 18-18 Telnet Configuration on a TCP/IP Network

18.12 Configuring TELNET

Click **REMOTE MANAGEMENT** to open the **TELNET** screen.

The screenshot shows the 'REMOTE MANAGEMENT' interface with the 'TELNET' tab selected. The configuration options are as follows:

Field	Value
Server Port	23
Server Access	LAN & WAN
Secure Client IP Address	All Selected, 0.0.0.0

Buttons: Apply, Reset

Figure 18-19 Telnet

The following table describes the labels in this screen.

Table 18-3 Telnet

LABEL	DESCRIPTION
Server Port	You may change the server port number for a service if needed, however you must use the same port number in order to use that service for remote management.
Server Access	Select the interface(s) through which a computer may access the ZyWALL using this service.
Secure Client IP Address	A secure client is a “trusted” computer that is allowed to communicate with the ZyWALL using this service. Select All to allow any computer to access the ZyWALL using this service. Choose Selected to just allow the computer with the IP address that you specify to access the ZyWALL using this service.
Apply	Click Apply to save your customized settings and exit this screen.
Reset	Click Reset to begin configuring this screen afresh.

18.13 Configuring FTP

You can upload and download the ZyWALL’s firmware and configuration files using FTP, please see the chapter on firmware and configuration file maintenance for details. To use this feature, your computer must have an FTP client.

To change your ZyWALL’s FTP settings, click **REMOTE MANAGEMENT**, then the **FTP** tab. The screen appears as shown.

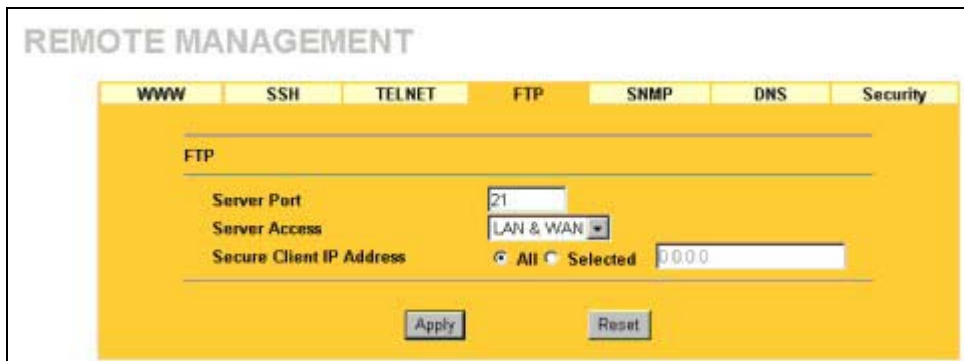

Figure 18-20 FTP

The following table describes the labels in this screen.

Table 18-4 FTP

LABEL	DESCRIPTION
Server Port	You may change the server port number for a service if needed, however you must use the same port number in order to use that service for remote management.
Server Access	Select the interface(s) through which a computer may access the ZyWALL using this service.
Secure Client IP Address	A secure client is a “trusted” computer that is allowed to communicate with the ZyWALL using this service. Select All to allow any computer to access the ZyWALL using this service. Choose Selected to just allow the computer with the IP address that you specify to access the ZyWALL using this service.
Apply	Click Apply to save your customized settings and exit this screen.
Reset	Click Reset to begin configuring this screen afresh.

18.14 Configuring SNMP

Simple Network Management Protocol is a protocol used for exchanging management information between network devices. SNMP is a member of the TCP/IP protocol suite. Your ZyWALL supports SNMP agent functionality, which allows a manager station to manage and monitor the ZyWALL through the network. The

ZyWALL supports SNMP version one (SNMPv1). The next figure illustrates an SNMP management operation. SNMP is only available if TCP/IP is configured.

SNMP is only available if TCP/IP is configured.

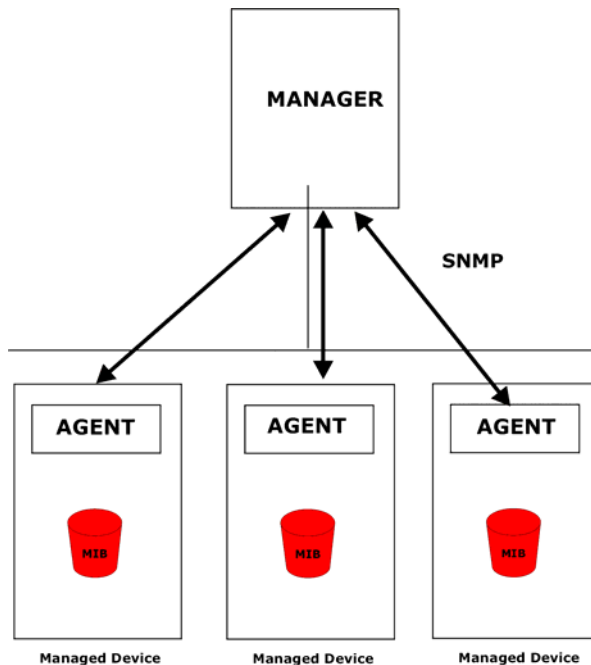

Figure 18-21 SNMP Management Model

An SNMP managed network consists of two main types of component: agents and a manager.

An agent is a management software module that resides in a managed device (the ZyWALL). An agent translates the local management information from the managed device into a form compatible with SNMP. The manager is the console through which network administrators perform network management functions. It executes applications that control and monitor managed devices.

The managed devices contain object variables/managed objects that define each piece of information to be collected about a device. Examples of variables include such as number of packets received, node port status

etc. A Management Information Base (MIB) is a collection of managed objects. SNMP allows a manager and agents to communicate for the purpose of accessing these objects.

SNMP itself is a simple request/response protocol based on the manager/agent model. The manager issues a request and the agent returns responses using the following protocol operations:

- Get - Allows the manager to retrieve an object variable from the agent.
- GetNext - Allows the manager to retrieve the next object variable from a table or list within an agent. In SNMPv1, when a manager wants to retrieve all elements of a table from an agent, it initiates a Get operation, followed by a series of GetNext operations.
- Set - Allows the manager to set values for object variables within an agent.
- Trap - Used by the agent to inform the manager of some events.

18.14.1 Supported MIBs

The ZyWALL supports MIB II that is defined in RFC-1213 and RFC-1215. The focus of the MIBs is to let administrators collect statistical data and monitor status and performance.

18.14.2 SNMP Traps

The ZyWALL will send traps to the SNMP manager when any one of the following events occurs:

Table 18-5 SNMP Traps

TRAP #	TRAP NAME	DESCRIPTION
0	coldStart (defined in <i>RFC-1215</i>)	A trap is sent after booting (power on).
1	warmStart (defined in <i>RFC-1215</i>)	A trap is sent after booting (software reboot).
4	authenticationFailure (defined in <i>RFC-1215</i>)	A trap is sent to the manager when receiving any SNMP get or set requirements with the wrong community (password).
6	whyReboot (defined in ZYXEL-MIB)	A trap is sent with the reason of restart before rebooting when the system is going to restart (warm start).
6a	For intentional reboot :	A trap is sent with the message "System reboot by user!" if reboot is done intentionally, (for example, download new files, CLI command "sys reboot", etc.).

Table 18-5 SNMP Traps

TRAP #	TRAP NAME	DESCRIPTION
6b	For fatal error :	A trap is sent with the message of the fatal code if the system reboots because of fatal errors.

18.14.3 REMOTE MANAGEMENT: SNMP

To change your ZyWALL’s SNMP settings, click **REMOTE MANAGEMENT**, then the **SNMP** tab. The screen appears as shown.

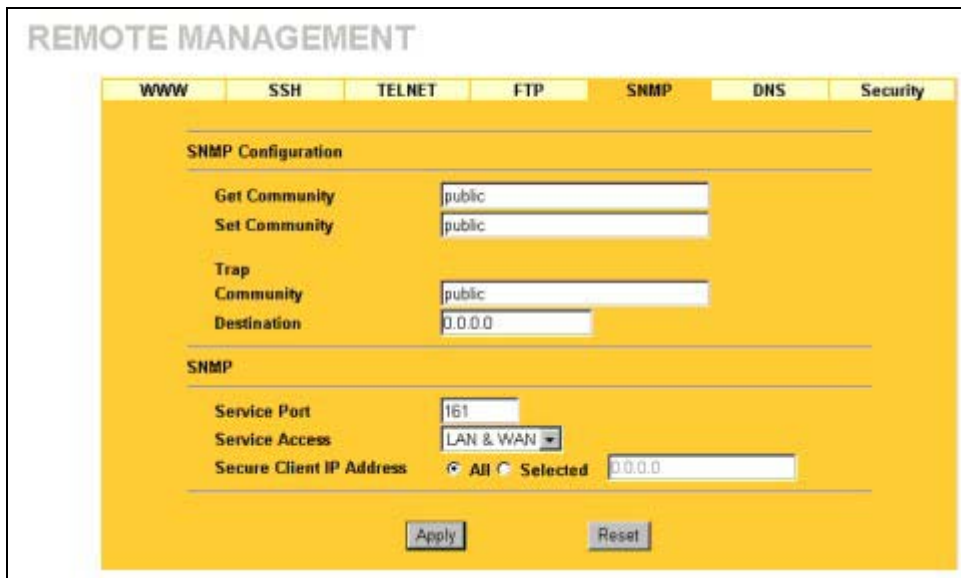

Figure 18-22 SNMP

The following table describes the labels in this screen.

Table 18-6 SNMP

LABEL	DESCRIPTION
SNMP Configuration	

Table 18-6 SNMP

LABEL	DESCRIPTION
Get Community	Enter the Get Community , which is the password for the incoming Get and GetNext requests from the management station. The default is public and allows all requests.
Set Community	Enter the Set community , which is the password for incoming Set requests from the management station. The default is public and allows all requests.
Trusted Host	If you enter a trusted host, your ZyWALL will only respond to SNMP messages from this address. 0.0.0.0 (default) means your ZyWALL will respond to all SNMP messages it receives, regardless of source.
Trap	
Community	Type the trap community, which is the password sent with each trap to the SNMP manager. The default is public and allows all requests.
Destination	Type the IP address of the station to send your SNMP traps to.
SNMP	
Service Port	You may change the server port number for a service if needed, however you must use the same port number in order to use that service for remote management.
Service Access	Select the interface(s) through which a computer may access the ZyWALL using this service.
Secure Client IP Address	<p>A secure client is a “trusted” computer that is allowed to communicate with the ZyWALL using this service.</p> <p>Select All to allow any computer to access the ZyWALL using this service.</p> <p>Choose Selected to just allow the computer with the IP address that you specify to access the ZyWALL using this service.</p>
Apply	Click Apply to save your customized settings and exit this screen.
Reset	Click Reset to begin configuring this screen afresh.

18.15 Configuring DNS

Use DNS (Domain Name System) to map a domain name to its corresponding IP address and vice versa. Refer to the *Internet Access* chapter for more information.

To change your ZyWALL’s DNS settings, click **REMOTE MANAGEMENT**, then the **DNS** tab. The screen appears as shown.

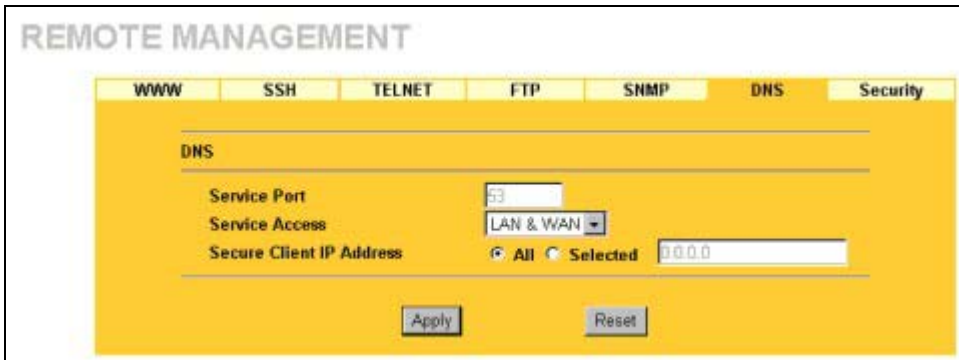

Figure 18-23 DNS

The following table describes the labels in this screen.

Table 18-7 DNS

LABEL	DESCRIPTION
Server Port	The DNS service port number is 53 and cannot be changed here.
Server Access	Select the interface(s) through which a computer may send DNS queries to the ZyWALL.
Secure Client IP Address	A secure client is a “trusted” computer that is allowed to send DNS queries to the ZyWALL. Select All to allow any computer to send DNS queries to the ZyWALL. Choose Selected to just allow the computer with the IP address that you specify to send DNS queries to the ZyWALL.
Apply	Click Apply to save your customized settings and exit this screen.
Reset	Click Reset to begin configuring this screen afresh.

18.16 Configuring Security

To change your ZyWALL’s security settings, click **REMOTE MANAGEMENT**, then the **Security** tab. The screen appears as shown.

If an outside user attempts to probe an unsupported port on your ZyWALL, an ICMP response packet is automatically returned. This allows the outside user to know the ZyWALL exists. The ZyWALL series

support anti-probing, which prevents the ICMP response packet from being sent. This keeps outsiders from discovering your ZyWALL when unsupported ports are probed.

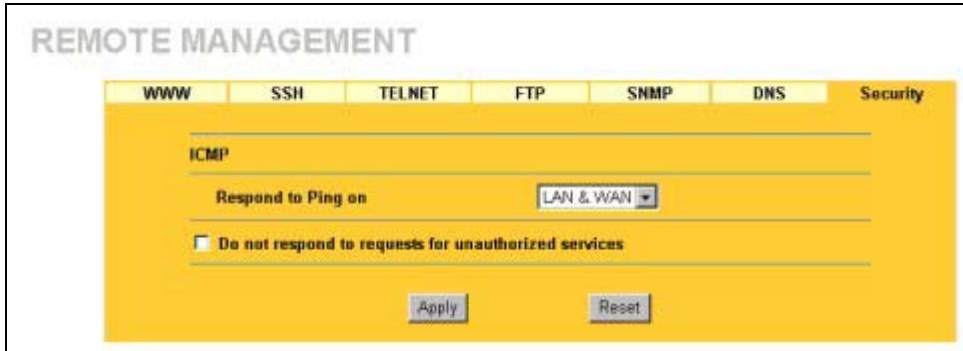

Figure 18-24 Security

The following table describes the labels in this screen.

Table 18-8 Security

LABEL	DESCRIPTION
ICMP	Internet Control Message Protocol is a message control and error-reporting protocol between a host server and a gateway to the Internet. ICMP uses Internet Protocol (IP) datagrams, but the messages are processed by the TCP/IP software and directly apparent to the application user.
Respond to Ping on	The ZyWALL will not respond to any incoming Ping requests when Disable is selected. Select LAN to reply to incoming LAN Ping requests. Select WAN to reply to incoming WAN Ping requests. Otherwise select LAN & WAN (& DMZ if your ZyWALL has a DMZ port) to reply to both incoming LAN and WAN (and DMZ if present) Ping requests.

Table 18-8 Security

LABEL	DESCRIPTION
Do not respond to requests for unauthorized services	<p>Select this option to prevent hackers from finding the ZyWALL by probing for unused ports. If you select this option, the ZyWALL will not respond to port request(s) for unused ports, thus leaving the unused ports and the ZyWALL unseen. By default this option is not selected and the ZyWALL will reply with an ICMP Port Unreachable packet for a port probe on its unused UDP ports, and a TCP Reset packet for a port probe on its unused TCP ports.</p> <p>Note that the probing packets must first traverse the ZyWALL 's firewall mechanism before reaching this anti-probing mechanism. Therefore if the firewall mechanism blocks a probing packet, the ZyWALL reacts based on the firewall policy, which by default, is to send a TCP reset packet for a blocked TCP packet. You can use the command "sys firewall tcprst rst [on off]" to change this policy. When the firewall mechanism blocks a UDP packet, it drops the packet without sending a response packet.</p>
Apply	Click Apply to save your customized settings and exit this screen.
Reset	Click Reset to begin configuring this screen afresh.

Chapter 19

UPnP

This chapter introduces the Universal Plug and Play feature.

19.1 Universal Plug and Play Overview

Universal Plug and Play (UPnP) is a distributed, open networking standard that uses TCP/IP for simple peer-to-peer network connectivity between devices. A UPnP device can dynamically join a network, obtain an IP address, convey its capabilities and learn about other devices on the network. In turn, a device can leave a network smoothly and automatically when it is no longer in use.

19.1.1 How Do I Know If I'm Using UPnP?

UPnP hardware is identified as an icon in the Network Connections folder (Windows XP). Each UPnP compatible device installed on your network will appear as a separate icon. Selecting the icon of a UPnP device will allow you to access the information and properties of that device.

19.1.2 NAT Traversal

UPnP NAT traversal automates the process of allowing an application to operate through NAT. UPnP network devices can automatically configure network addressing, announce their presence in the network to other UPnP devices and enable exchange of simple product and service descriptions. NAT traversal allows the following:

- Dynamic port mapping
- Learning public IP addresses
- Assigning lease times to mappings

Windows Messenger is an example of an application that supports NAT traversal and UPnP.

See the *SUA/NAT* chapter for further information about NAT.

19.1.3 Cautions with UPnP

The automated nature of NAT traversal applications in establishing their own services and opening firewall ports may present network security issues. Network information and configuration may also be obtained and modified by users in some network environments.

All UPnP-enabled devices may communicate freely with each other without additional configuration. Disable UPnP if this is not your intention.

19.2 UPnP and ZyXEL

ZyXEL has achieved UPnP certification from the Universal Plug and Play Forum Creates UPnP™ Implementers Corp. (UIC). ZyXEL's UPnP implementation supports IGD 1.0 (Internet Gateway Device). At the time of writing ZyXEL's UPnP implementation supports Windows Messenger 4.6 and 4.7 while Windows Messenger 5.0 and Xbox are still being tested.

UPnP broadcasts are only allowed on the LAN.

Please see later in this *User's Guide* for examples of installing UPnP in Windows XP and Windows Me as well as an example of using UPnP in Windows.

19.3 Configuring UPnP

Click **UPnP** to display the screen shown next.



Figure 19-1 Configuring UPnP

The following table describes the labels in this screen.

Table 19-1 Configuring UPnP

LABEL	DESCRIPTION
Device Name	This identifies this ZyXEL device in UPnP applications.
Enable the Universal Plug and Play (UPnP) feature	Select this checkbox to activate UPnP. Be aware that anyone could use a UPnP application to open the web configurator's login screen without entering the ZyWALL's IP address (although you must still enter the password to access the web configurator).
Allow users to make configuration changes through UPnP	Select this check box to allow UPnP-enabled applications to automatically configure the ZyWALL so that they can communicate through the ZyWALL, for example by using NAT traversal, UPnP applications automatically reserve a NAT forwarding port in order to communicate with another UPnP enabled device; this eliminates the need to manually configure port forwarding for the UPnP enabled application.
Allow UPnP to pass through firewall	Select this check box to allow traffic from UPnP-enabled applications to bypass the firewall. Clear this check box to have the firewall block all UPnP application packets (for example, MSN packets).
Apply	Click Apply to save your changes back to the ZyWALL.
Reset	Click Reset to begin configuring this screen afresh.

19.4 Displaying UPnP Port Mapping

Click **UPnP** and then **Ports** to open the **UPnP Ports** screen. Use this screen to view the NAT port forwarding entries that UPnP creates on the ZyWALL.

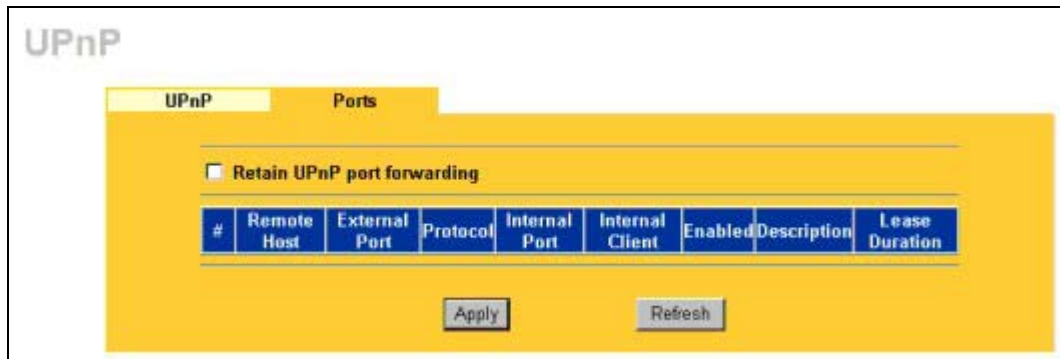

Figure 19-2 UPnP Ports

The following table describes the labels in this screen.

Table 19-2 UPnP Ports

LABEL	DESCRIPTION
Retain UPnP port forwarding	Select this checkbox to have the ZyWALL keep UPnP created NAT port forwarding entries (rules) even after restarting. If you use UPnP and you set a port on your computer to be fixed for a specific service (for example FTP for file transfers), this option allows the ZyWALL to keep a record when your computer uses UPnP to create a NAT forwarding entry for that service.
The following read-only table displays information about the UPnP-created NAT port forwarding entries in the ZyWALL's NAT routing table.	
#	This is the index number of the UPnP-created NAT port forwarding entry.
Remote Host	This field displays the source IP address (on the WAN) of inbound IP packets. Since this is often a wildcard, the field may be blank. When the field is blank, the ZyWALL forwards all traffic sent to the External Port on the WAN interface to the Internal Client on the Internal Port . When this field displays an external IP address, the NAT port forwarding entry has the ZyWALL forward inbound packets to the Internal Client from that IP address only.

Table 19-2 UPnP Ports

LABEL	DESCRIPTION
External Port	This field displays the port number that the ZyWALL “listens” on (on the WAN port) for connection requests destined for the NAT port forwarding entry’s Internal Port and Internal Client . The ZyWALL forwards incoming packets (from the WAN) with this port number to the Internal Client on the Internal Port (on the LAN). If the field displays “0”, the ZyWALL ignores the Internal Port value and forwards requests on all external port numbers (that are otherwise unmapped) to the Internal Client .
Protocol	This field displays the protocol of the NAT port forwarding entry (TCP or UDP).
Internal Port	This field displays the port number on the Internal Client to which the ZyWALL should forward incoming connection requests.
Internal Client	This field displays the DNS host name or IP address of a client on the LAN. Multiple NAT clients can use a single port simultaneously if the Internal Client field is set to 255.255.255.255 for UDP mappings.
Enabled	This field displays whether or not this UPnP-created NAT port forwarding entry is turned on. The UPnP-enabled device that connected to the ZyWALL and configured the UPnP-created NAT port forwarding entry on the ZyWALL determines whether or not the entry is enabled.
Description	This field displays a text explanation of the NAT port forwarding entry.
Lease Duration	This field displays a dynamic port forwarding entry’s time to live (in seconds). It displays “0” if the port mapping is static.
Apply	Click Apply to save your changes back to the ZyWALL.
Refresh	Click Refresh update the screen’s table.

19.5 Installing UPnP in Windows Example

This section shows how to install UPnP in Windows Me and Windows XP.

19.5.1 Installing UPnP in Windows Me

Follow the steps below to install UPnP in Windows Me.

- Step 1.** Click **Start** and **Control Panel**. Double-click **Add/Remove Programs**.
- Step 2.** Click on the **Windows Setup** tab and select **Communication** in the **Components** selection box. Click **Details**.

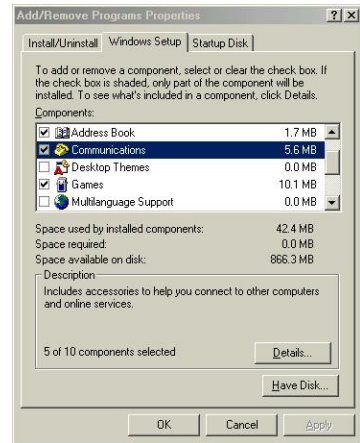

- Step 3.** In the **Communications** window, select the **Universal Plug and Play** check box in the **Components** selection box.

- Step 4.** Click **OK** to go back to the **Add/Remove Programs Properties** window and click **Next**.

- Step 5.** Restart the computer when prompted.

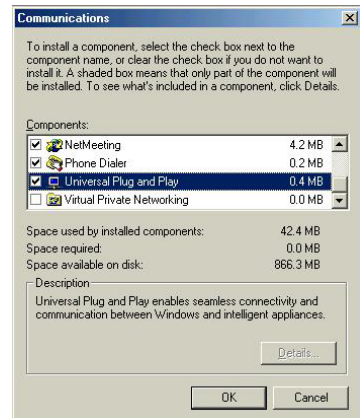

19.5.2 Installing UPnP in Windows XP

Follow the steps below to install UPnP in Windows XP.

- Step 1.** Click **Start** and **Control Panel**.
- Step 2.** Double-click **Network Connections**.
- Step 3.** In the **Network Connections** window, click **Advanced** in the main menu and select **Optional Networking Components ...**.
The **Windows Optional Networking Components Wizard** window displays.

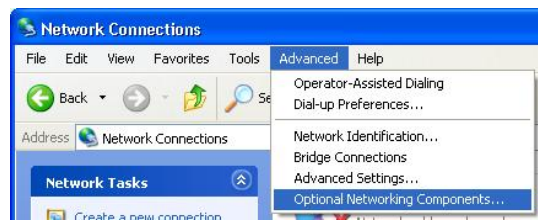

Step 4. Select **Networking Service** in the **Components** selection box and click **Details**.

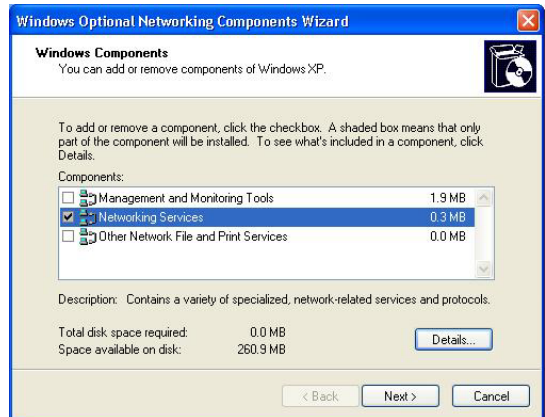

Step 5. In the **Networking Services** window, select the **Universal Plug and Play** check box.

Step 6. Click **OK** to go back to the **Windows Optional Networking Component Wizard** window and click **Next**.

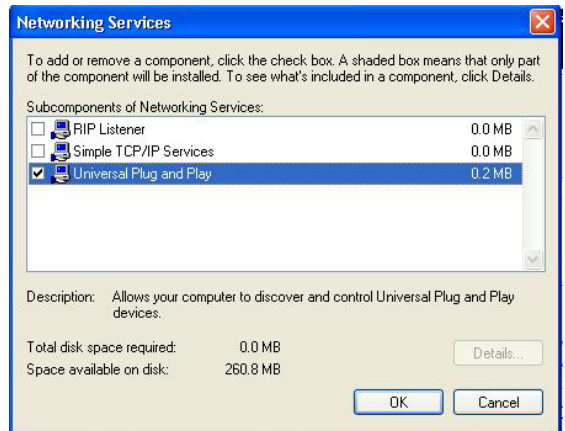

19.6 Using UPnP in Windows XP Example

This section shows you how to use the UPnP feature in Windows XP. You must already have UPnP installed in Windows XP and UPnP activated on the ZyXEL device.

Make sure the computer is connected to a LAN port of the ZyXEL device. Turn on your computer and the ZyXEL device.

19.6.1 Auto-discover Your UPnP-enabled Network Device

Step 1. Click **Start** and **Control Panel**. Double-click **Network Connections**. An icon displays under Internet Gateway.

Step 2. Right-click the icon and select **Properties**.



Step 3. In the **Internet Connection Properties** window, click **Settings** to see the port mappings that were automatically created.



Step 4. You may edit or delete the port mappings or click **Add** to manually add port mappings.

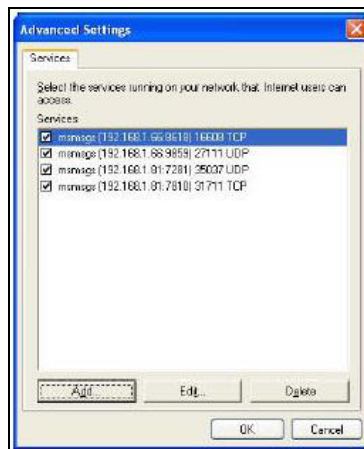

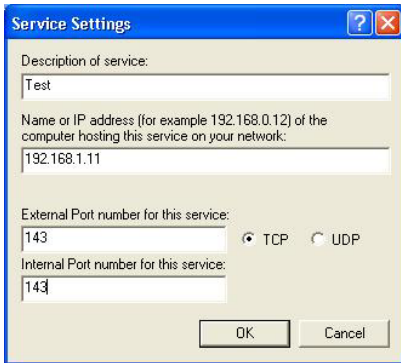

When the UPnP-enabled device is disconnected from your computer, all port mappings will be deleted automatically.

- Step 5.** Select the **Show icon in notification area when connected** check box and click **OK**. An icon displays in the system tray

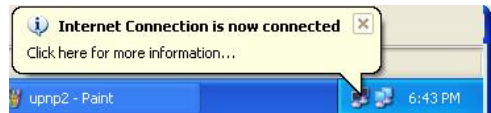

- Step 6.** Double-click the icon to display your current Internet connection status.



19.6.2 Web Configurator Easy Access

With UPnP, you can access the web-based configurator on the ZyXEL device without finding out the IP address of the ZyXEL device first. This is helpful if you do not know the IP address of the ZyXEL device.

Follow the steps below to access the web configurator.

- Step 1.** Click **Start** and then **Control Panel**.
- Step 2.** Double-click **Network Connections**.
- Step 3.** Select **My Network Places** under **Other Places**.

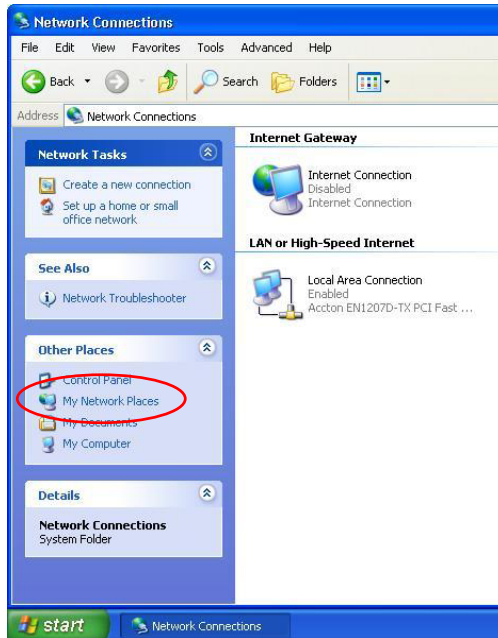

- Step 4.** An icon with the description for each UPnP-enabled device displays under **Local Network**.
- Step 5.** Right-click the icon for your ZyXEL device and select **Invoke**. The web configurator login screen displays.

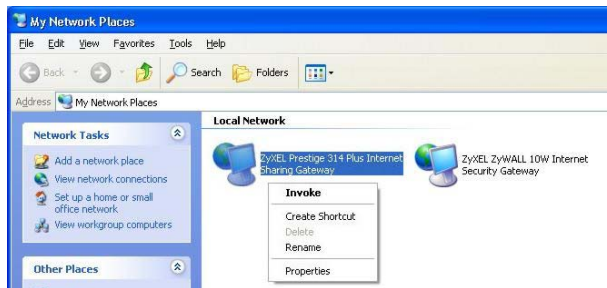

Step 6. Right-click the icon for your ZyXEL device and select **Properties**. A properties window displays with basic information about the ZyXEL device.



Part IX:

Logs

This part provides information and instructions for the logs and reports.

Chapter 20

Logs Screens

This chapter contains information about configuring general log settings and viewing the ZyWALL's logs. Refer to the Appendices for example log message explanations.

20.1 Configuring View Log

The web configurator allows you to look at all of the ZyWALL's logs in one location.

Click **LOGS** to open the **View Log** screen. Use the **View Log** screen to see the logs for the categories that you selected in the **Log Settings** screen (see *section 20.2*). Options include logs about system maintenance, system errors, access control, allowed or blocked web sites, blocked web features (such as ActiveX controls, java and cookies), attacks (such as DoS) and IPSec.

Log entries in red indicate system error logs. The log wraps around and deletes the old entries after it fills. Click a column heading to sort the entries. A triangle indicates ascending or descending sort order.

LOGS

View Log Log Settings Reports

Display: All Logs Email Log Now Refresh Clear Log

#	Time ▲	Message	Source	Destination	Notes
1	01/10/2003 01:55:52	Firewall default policy: UDP (W to W/ZW)	172.21.4.47:138	172.21.255.255:138	ACCESS BLOCK
2	01/10/2003 01:55:51	Firewall default policy: UDP (W to W/ZW)	172.21.1.230:137	172.21.255.255:137	ACCESS BLOCK
3	01/10/2003 01:55:51	Firewall default policy: UDP (W to W/ZW)	172.21.3.97:137	172.21.255.255:137	ACCESS BLOCK
4	01/10/2003 01:55:50	Firewall default policy: UDP (W to W/ZW)	172.21.3.97:137	172.21.255.255:137	ACCESS BLOCK
5	01/10/2003 01:55:49	Firewall default policy: UDP (W to W/ZW)	172.21.3.97:137	172.21.255.255:137	ACCESS BLOCK
6	01/10/2003 01:55:47	Firewall default policy: UDP (W to W/ZW)	172.21.4.141:138	172.21.255.255:138	ACCESS BLOCK
7	01/10/2003 01:55:47	Firewall default policy: UDP (W to W/ZW)	172.21.4.141:138	172.21.255.255:138	ACCESS BLOCK
8	01/10/2003 01:55:46	Firewall default policy: UDP (W to W/ZW)	172.21.3.97:137	172.21.255.255:137	ACCESS BLOCK
9	01/10/2003 01:55:46	Firewall default policy: UDP (W to W/ZW)	172.21.3.10:138	172.21.255.255:138	ACCESS BLOCK
10	01/10/2003 01:55:46	Firewall default policy: UDP (W to W/ZW)	172.21.3.97:137	172.21.255.255:137	ACCESS BLOCK
11	01/10/2003 01:55:45	Firewall default policy: UDP (W to W/ZW)	172.21.3.97:137	172.21.255.255:137	ACCESS BLOCK
12	01/10/2003 01:55:45	Firewall default policy: UDP (W to W/ZW)	172.21.4.23:137	172.21.255.255:137	ACCESS BLOCK
13	01/10/2003 01:55:44	Firewall default policy: UDP (W to W/ZW)	172.21.4.23:137	172.21.255.255:137	ACCESS BLOCK
14	01/10/2003 01:55:43	Firewall default policy: UDP (W to W/ZW)	172.21.4.23:137	172.21.255.255:137	ACCESS BLOCK

Figure 20-1 View Log

The following table describes the labels in this screen.

Table 20-1 View Log

LABEL	DESCRIPTION
Display	<p>The categories that you select in the Log Settings page (see <i>section 20.2</i>) display in the drop-down list box.</p> <p>Select a category of logs to view; select All Logs to view logs from all of the log categories that you selected in the Log Settings page.</p>

Table 20-1 View Log

LABEL	DESCRIPTION
Time	This field displays the time the log was recorded. See the chapter on system maintenance and information to configure the ZyWALL's time and date.
Message	This field states the reason for the log.
Source	This field lists the source IP address and the port number of the incoming packet.
Destination	This field lists the destination IP address and the port number of the incoming packet.
Note	This field displays additional information about the log entry.
Email Log Now	Click Email Log Now to send the log screen to the e-mail address specified in the Log Settings page (make sure that you have first filled in the Address Info fields in Log Settings , see <i>section 20.2</i>).
Refresh	Click Refresh to renew the log screen.
Clear Log	Click Clear Log to delete all the logs.

20.2 Configuring Log Settings

To change your ZyWALL's log settings, click **Logs**, then the **Log Settings** tab. The screen appears as shown.

Use the **Log Settings** screen to configure to where the ZyWALL is to send logs; the schedule for when the ZyWALL is to send the logs and which logs and/or immediate alerts the ZyWALL is to send.

An alert is a type of log that warrants more serious attention. They include system errors, attacks (access control) and attempted access to blocked web sites or web sites with restricted web features such as cookies, active X and so on. Some categories such as **System Errors** consist of both logs and alerts. You may differentiate them by their color in the **View Log** screen. Alerts display in red and logs display in black.

Alerts are e-mailed as soon as they happen. Logs may be e-mailed as soon as the log is full (see Log Schedule). Selecting many alert and/or log categories (especially Access Control) may result in many e-mails being sent.

LOGS

View Log
Log Settings
Reports

Address Info

Mail Server (Outgoing SMTP Server Name or IP Address)

Mail Subject

Send Log to (E-Mail Address)

Send Alerts to (E-Mail Address)

Syslog Logging

Active

Syslog Server IP Address (Server Name or IP Address)

Log Facility

Send Log

Log Schedule

Day for Sending Log

Time for Sending Log (Hour) (Minute)

Log

- System Maintenance
- System Errors
- Access Control
- TCP Reset
- Packet Filter
- ICMP
- UPnP
- Forward Web Sites
- Blocked Web Sites
- Blocked Java etc.
- Attacks
- IPSec
- IKE
- PKI
- 802.1X

Send Immediate Alert

- System Errors
- Access Control
- Blocked Web Sites
- Blocked Java etc.
- Attacks
- IPSec
- IKE
- PKI

Figure 20-2 Log Settings

The following table describes the labels in this screen.

Table 20-2 Log Settings Screen

LABEL	DESCRIPTION
Address Info	
Mail Server	Enter the server name or the IP address of the mail server for the e-mail addresses specified below. If this field is left blank, logs and alert messages will not be sent via e-mail.
Mail Subject	Type a title that you want to be in the subject line of the log e-mail message that the ZyWALL sends.
Send Log To	Logs are sent to the e-mail address specified in this field. If this field is left blank, logs will not be sent via e-mail.
Send Alerts To	Alerts are sent to the e-mail address specified in this field. If this field is left blank, alerts will not be sent via e-mail.
Syslog Logging	
Active	Click Active to enable syslog logging.
Syslog Server IP Address	Enter the server name or IP address of the syslog server that will log the selected categories of logs.
Log Facility	Select a location from the drop down list box. The log facility allows you to log the messages to different files in the syslog server. Refer to the documentation of your syslog program for more details.
Send Log	
Log Schedule	<p>This drop-down menu is used to configure the frequency of log messages being sent as E-mail:</p> <ul style="list-style-type: none"> • Daily • Weekly • Hourly • When Log is Full • None. <p>If you select Weekly or Daily, specify a time of day when the E-mail should be sent. If you select Weekly, then also specify which day of the week the E-mail should be sent. If you select When Log is Full, an alert is sent when the log fills up. If you select None, no log messages are sent</p>
Day for Sending Log	Use the drop down list box to select which day of the week to send the logs.
Time for Sending Log	Enter the time of the day in 24-hour format (for example 23:00 equals 11:00 pm) to send the logs.

Table 20-2 Log Settings Screen

LABEL	DESCRIPTION
Log	Select the categories of logs that you want to record. Logs include alerts.
Send Immediate Alert	Select the categories of alerts for which you want the ZyWALL to instantly e-mail alerts to the e-mail address specified in the Send Alerts To field.
Apply	Click Apply to save your customized settings and exit this screen.
Reset	Click Reset to begin configuring this screen afresh.

20.3 Configuring Reports

The **Reports** screen displays which computers on the LAN send and receive the most traffic, what kinds of traffic are used the most and which web sites are visited the most often. Use the **Reports** screen to have the ZyWALL record and display the following network usage details:

- Web sites visited the most often
- Number of times the most visited web sites were visited
- The most-used protocols or service ports
- The amount of traffic for the most used protocols or service ports
- The LAN IP addresses to and/or from which the most traffic has been sent
- How much traffic has been sent to and from the LAN IP addresses to and/or from which the most traffic has been sent

The web site hit count may not be 100% accurate because sometimes when an individual web page loads, it may contain references to other web sites that also get counted as hits.

The ZyWALL records web site hits by counting the HTTP GET packets. Many web sites include HTTP GET references to other web sites and the ZyWALL may count these as hits, thus the web hit count is not (yet) 100% accurate.

To view your ZyWALL's log reports, click **Logs**, then the **Reports** tab. The screen appears as shown.

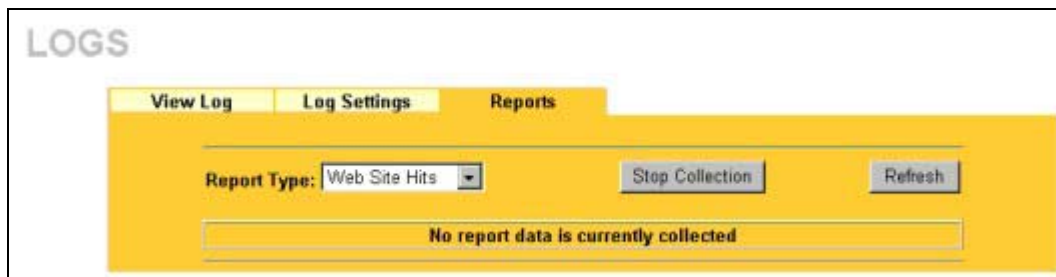

Figure 20-3 Reports

Enabling the ZyWALL's reporting function decreases the overall throughput by about 1 Mbps.

The following table describes the labels in this screen.

Table 20-3 Reports

LABEL	DESCRIPTION
Report Type	<p>Use the drop-down list box to select the type of reports to display.</p> <p>Web Site Hits displays the web sites that have been visited the most often from the LAN and how many times they have been visited.</p> <p>Protocol/Port displays the protocols or service ports that have been used the most and the amount of traffic for the most used protocols or service ports.</p> <p>LAN IP Address displays the LAN IP addresses to and /or from which the most traffic has been sent and how much traffic has been sent to and from those IP addresses.</p>
Start Collection/ Stop Collection	<p>The button text shows Start Collection when the ZyWALL is not recording report data and Stop Collection when the ZyWALL is recording report data.</p> <p>Click Start Collection to have the ZyWALL record report data.</p> <p>Click Stop Collection to halt the ZyWALL from recording more data.</p>
Refresh	<p>Click Refresh to update the report display. The report also refreshes automatically when you close and reopen the screen.</p>

All of the recorded reports data is erased when you turn off the ZyWALL.

20.3.1 Viewing Web Site Hits

In the **Reports** screen, select **Web Site Hits** from the **Report Type** drop-down list box to have the ZyWALL record and display which web sites have been visited the most often and how many times they have been visited.

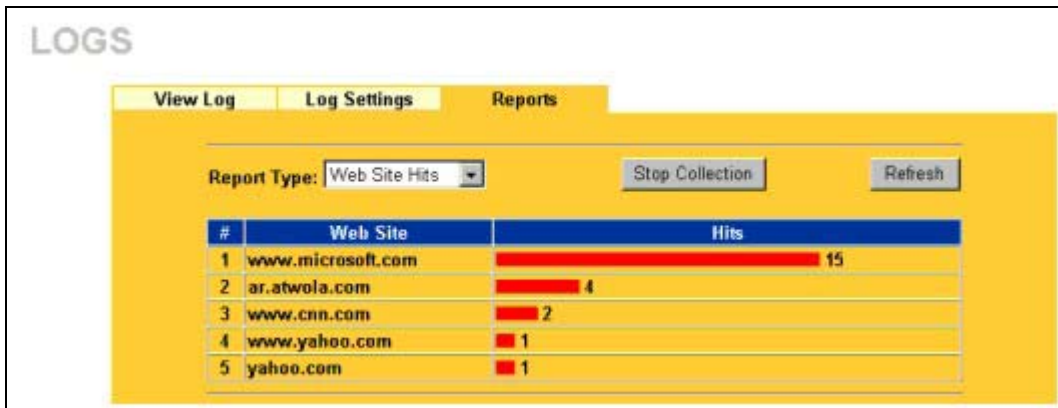

Figure 20-4 Web Site Hits Report Example

The following table describes the labels in this screen.

Table 20-4 Web Site Hits Report

LABEL	DESCRIPTION
Web Site	This column lists the domain names of the web sites visited most often from computers on the LAN. The names are ranked by the number of visits to each web site and listed in descending order with the most visited web site listed first. The ZyWALL counts each page viewed in a web site as another hit on the web site.
Hits	This column lists how many times each web site has been visited. The count starts over at 0 if a web site passes the hit count limit (see <i>Table 20-7 Report Specifications</i>).

20.3.2 Viewing Protocol/Port

In the **Reports** screen, select **Protocol/Port** from the **Report Type** drop-down list box to have the ZyWALL record and display which protocols or service ports have been used the most and the amount of traffic for the most used protocols or service ports.

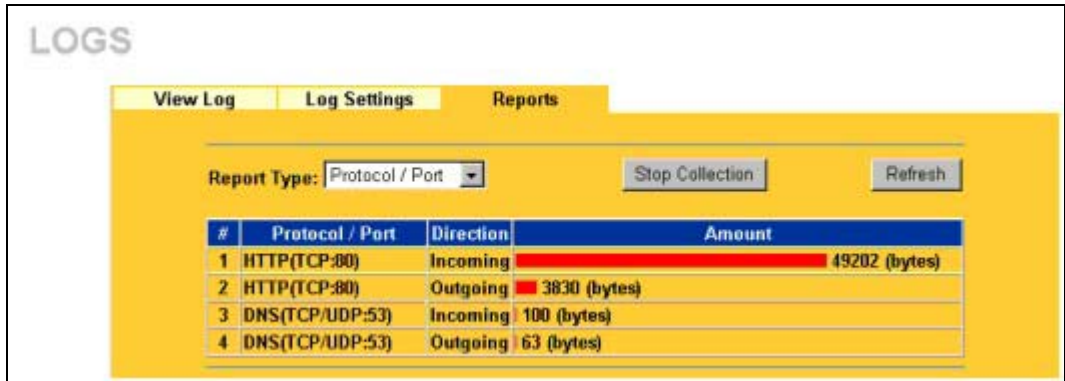

Figure 20-5 Protocol/Port Report Example

The following table describes the labels in this screen.

Table 20-5 Protocol/ Port Report

LABEL	DESCRIPTION
Protocol/Port	This column lists the protocols or service ports for which the most traffic has gone through the ZyWALL. The protocols or service ports are listed in descending order with the most used protocol or service port listed first.
Direction	This column lists the direction of travel of the traffic belonging to each protocol or service port listed. Incoming refers to traffic that is coming into the ZyWALL's LAN from the WAN. Outgoing refers to traffic that is going out from the ZyWALL's LAN to the WAN.
Amount	This column lists how much traffic has been sent and/or received for each protocol or service port. The measurement unit shown (bytes, Kbytes, Mbytes or Gbytes) varies with the amount of traffic for the particular protocol or service port. The count starts over at 0 if a protocol or port passes the bytes count limit (see <i>Table 20-7 Report Specifications</i>).

20.3.3 Viewing LAN IP Address

In the **Reports** screen, select **LAN IP Address** from the **Report Type** drop-down list box to have the ZyWALL record and display the LAN IP addresses that the most traffic has been sent to and/or from and how much traffic has been sent to and/or from those IP addresses.

Computers take turns using dynamically assigned LAN IP addresses. The ZyWALL continues recording the bytes sent to or from a LAN IP address when it is assigned to a different computer.



Figure 20-6 LAN IP Address Report Example

The following table describes the labels in this screen.

Table 20-6 LAN IP Address Report

LABEL	DESCRIPTION
IP Address	This column lists the LAN IP addresses to and/or from which the most traffic has been sent. The LAN IP addresses are listed in descending order with the LAN IP address to and/or from which the most traffic was sent listed first.
Amount	This column displays how much traffic has gone to and from the listed LAN IP addresses. The measurement unit shown (bytes, Kbytes, Mbytes or Gbytes) varies with the amount of traffic sent to and from the LAN IP address. The count starts over at 0 if the total traffic sent to and from a LAN IP passes the bytes count limit (see <i>Table 20-7 Report Specifications</i>).

20.3.4 Reports Specifications

The following table lists detailed specifications on the reports feature.

Table 20-7 Report Specifications

LABEL	DESCRIPTION
Number of web sites/protocols or ports/IP addresses listed:	20
Hit count limit:	Up to 2^{32} hits can be counted per web site. The count starts over at 0 if it passes four billion.
Bytes count limit:	Up to 2^{64} bytes can be counted per protocol/port or LAN IP address. The count starts over at 0 if it passes 2^{64} bytes.

Part X:

Maintenance

This part covers the maintenance screens.

Chapter 21

Maintenance

This chapter displays system information such as ZyNOS firmware, port IP addresses and port traffic statistics.

21.1 Maintenance Overview

The maintenance screens can help you view system information, upload new firmware, manage configuration and restart your ZyWALL.

21.2 Status Screen

Click **MAINTENANCE** to open the **Status** screen, where you can use to monitor your ZyWALL. Note that these fields are READ-ONLY and are meant to be used for diagnostic purposes.

MAINTENANCE

[Status](#) [DHCP Table](#) [F/W Upload](#) [Configuration](#) [Restart](#)

System Name :

Model Name : ZyWALL 10W
 ZyNOS Firmware Version: V3.61(WH.0) | 06/18/2003
 Routing Protocols : IP

WAN Port :

IP Address : 172.21.4.238 DHCP : Client
 IP Subnet Mask : 255.255.0.0

LAN Port :

IP Address : 192.168.1.1 DHCP : Server
 IP Subnet Mask : 255.255.255.0

Show Statistics

Figure 21-1 System Status

The following table describes the labels in this screen.

Table 21-1 System Status

LABEL	DESCRIPTION
System Name	This is the System Name you chose in the first Internet Access Wizard screen. It is for identification purposes
Model Name	The model name identifies your device type. The model name should also be on a sticker on your device. If you are uploading firmware, be sure to upload firmware for this exact model name. This field is not available on all models.
ZyNOS Firmware Version:	This is the ZyNOS Firmware version and the date created. ZyNOS is ZyXEL's proprietary Network Operating System design.
Routing Protocols	This shows the routing protocol - IP for which the ZyWALL is configured. This field is not configurable in all ZyWALL router models.
WAN Port	
IP Address	This is the WAN port IP address.
IP Subnet Mask	This is the WAN port subnet mask.
DHCP	This is the WAN port DHCP role - Client or None .
LAN Port	
IP Address	This is the LAN port IP address.
IP Subnet Mask	This is the LAN port subnet mask.
DHCP	This is the LAN port DHCP role - Server , Relay (not all ZyWALL models) or None .
DMZ Port (not available on all ZyWALL models)	
IP Address	This is the DMZ port IP address.
IP Subnet Mask	This is the DMZ port subnet mask.
DHCP	This is the DMZ port DHCP role - Server , Relay (not all ZyWALL models) or None .
Show Statistics	Click Show Statistics to see router performance statistics such as number of packets sent and number of packets received for each port.

21.2.1 System Statistics

Read-only information here includes port status and packet specific statistics. Also provided are "system up time" and "poll interval(s)". The **Poll Interval(s)** field is configurable.

Port	Status	TxPkts	RxPkts	Collisions	Tx B/s	Rx B/s	Up Time
WAN	Down	0	0	0	0	0	00:00:00
LAN	100M/Full	1522	1625	0	5729	979	0:12:45

System Up Time : 0:12:51

Poll Interval(s) :

Figure 21-2 System Status: Show Statistics

The following table describes the labels in this screen.

Table 21-2 System Status: Show Statistics

LABEL	DESCRIPTION
Port	This is the WAN, LAN, DMZ or Wireless LAN port.
Status	This displays the port speed and duplex setting if you're using Ethernet encapsulation and down (line is down), idle (line (ppp) idle), dial (starting to trigger a call) and drop (dropping a call) if you're using PPPoE encapsulation.
TxPkts	This is the number of transmitted packets on this port.
RxPkts	This is the number of received packets on this port.
Collisions	This is the number of collisions on this port.
Tx B/s	This displays the transmission speed in bytes per second on this port.
Rx B/s	This displays the reception speed in bytes per second on this port.
Up Time	This is the total amount of time the line has been up.
System Up Time	This is the total time the ZyWALL has been on.
Poll Interval(s)	Enter the time interval for refreshing statistics in this field.
Set Interval	Click this button to apply the new poll interval you entered in the Poll Interval(s) field.

Table 21-2 System Status: Show Statistics

LABEL	DESCRIPTION
Stop	Click Stop to stop refreshing statistics, click Stop .

21.3 DHCP Table Screen

DHCP (Dynamic Host Configuration Protocol, RFC 2131 and RFC 2132) allows individual clients to obtain TCP/IP configuration at start-up from a server. You can configure the ZyWALL as a DHCP server or disable it. When configured as a server, the ZyWALL provides the TCP/IP configuration for the clients. If set to **None**, DHCP service will be disabled and you must have another DHCP server on your LAN, or else the computer must be manually configured.

Click **MAINTENANCE**, and then the **DHCP Table** tab. Read-only information here relates to your DHCP status. The DHCP table shows current DHCP client information (including **IP Address**, **Host Name** and **MAC Address**) of all network clients using the DHCP server.

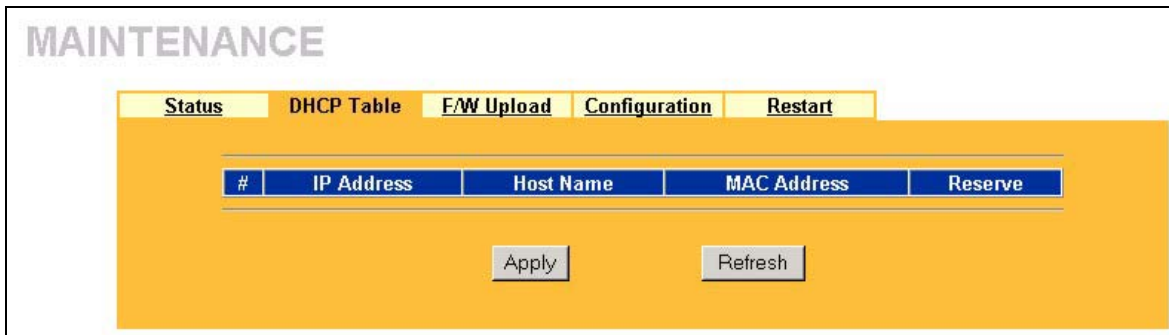
**Figure 21-3 DHCP Table**

The following table describes the labels in this screen.

Table 21-3 DHCP Table

LABEL	DESCRIPTION
#	This is the index number of the host computer.
IP Address	This field displays the IP address relative to the # field listed above.
Host Name	This field displays the computer host name.

Table 21-3 DHCP Table

LABEL	DESCRIPTION
MAC Address	This field shows the MAC address of the computer with the name in the Host Name field. Every Ethernet device has a unique MAC (Media Access Control) address. The MAC address is assigned at the factory and consists of six pairs of hexadecimal characters, for example, 00:A0:C5:00:00:02.
Reserve	Select this check box to have the ZyWALL always assign this IP address to this MAC address (and host name). After you click Apply , the MAC address and IP address also display in the LAN Static DHCP screen (where you can edit them). This feature is not available on all models.
Refresh	Click Refresh to renew the screen.

21.4 F/W Upload Screen

Find firmware at www.zyxel.com in a file that (usually) uses the system model name with a ".bin" extension, e.g., "zywall.bin". The upload process uses HTTP (Hypertext Transfer Protocol) and may take up to two minutes. After a successful upload, the system will reboot. See the *Firmware and Configuration File Maintenance* chapter in the *SMT User's Guide* for upgrading firmware using FTP/TFTP commands.

Click **MAINTENANCE**, and then the **F/W UPLOAD** tab. Follow the instructions in this screen to upload firmware to your ZyWALL.

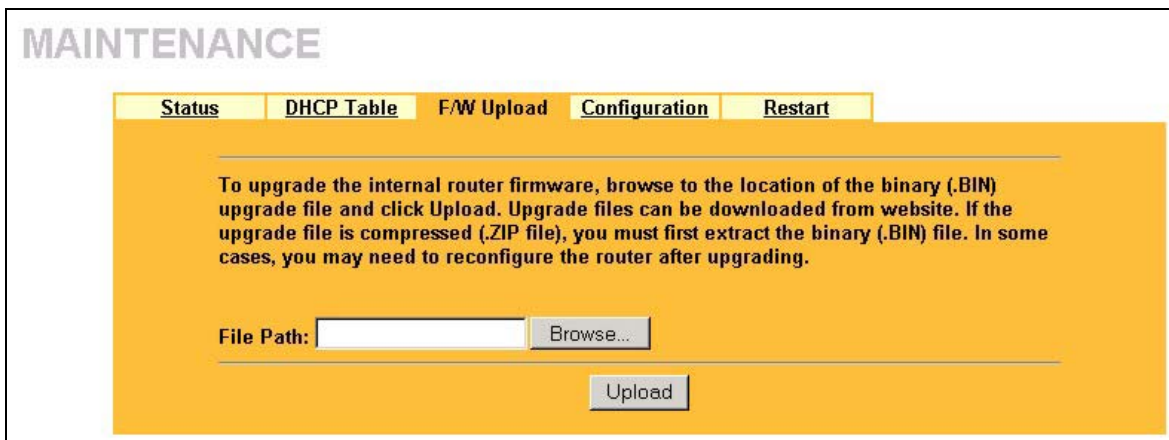

Figure 21-4 Firmware Upload

The following table describes the labels in this screen.

Figure 21-5 Firmware Upload

LABEL	DESCRIPTION
File Path	Type in the location of the file you want to upload in this field or click Browse ... to find it.
Browse...	Click Browse... to find the .bin file you want to upload. Remember that you must decompress compressed (.zip) files before you can upload them.
Upload	Click Upload to begin the upload process. This process may take up to two minutes.

Do not turn off the device while firmware upload is in progress!

After you see the **Firmware Upload in Process** screen, wait two minutes before logging into the device again.



Figure 21-6 Firmware Upload In Process

The device automatically restarts in this time causing a temporary network disconnect. In some operating systems, you may see the following icon on your desktop.



Figure 21-7 Network Temporarily Disconnected

After two minutes, log in again and check your new firmware version in the **System Status** screen.

If the upload was not successful, the following screen will appear. Click **Return** to go back to the **F/W Upload** screen.



Figure 21-8 Firmware Upload Error

21.5 Configuration Screen

See the *Firmware and Configuration File Maintenance* chapter in the *SMT User's Guide* for transferring configuration files using FTP/TFTP commands.

Click **MAINTENANCE**, and then the **Configuration** tab. Information related to factory defaults, backup configuration, and restoring configuration appears as shown next.

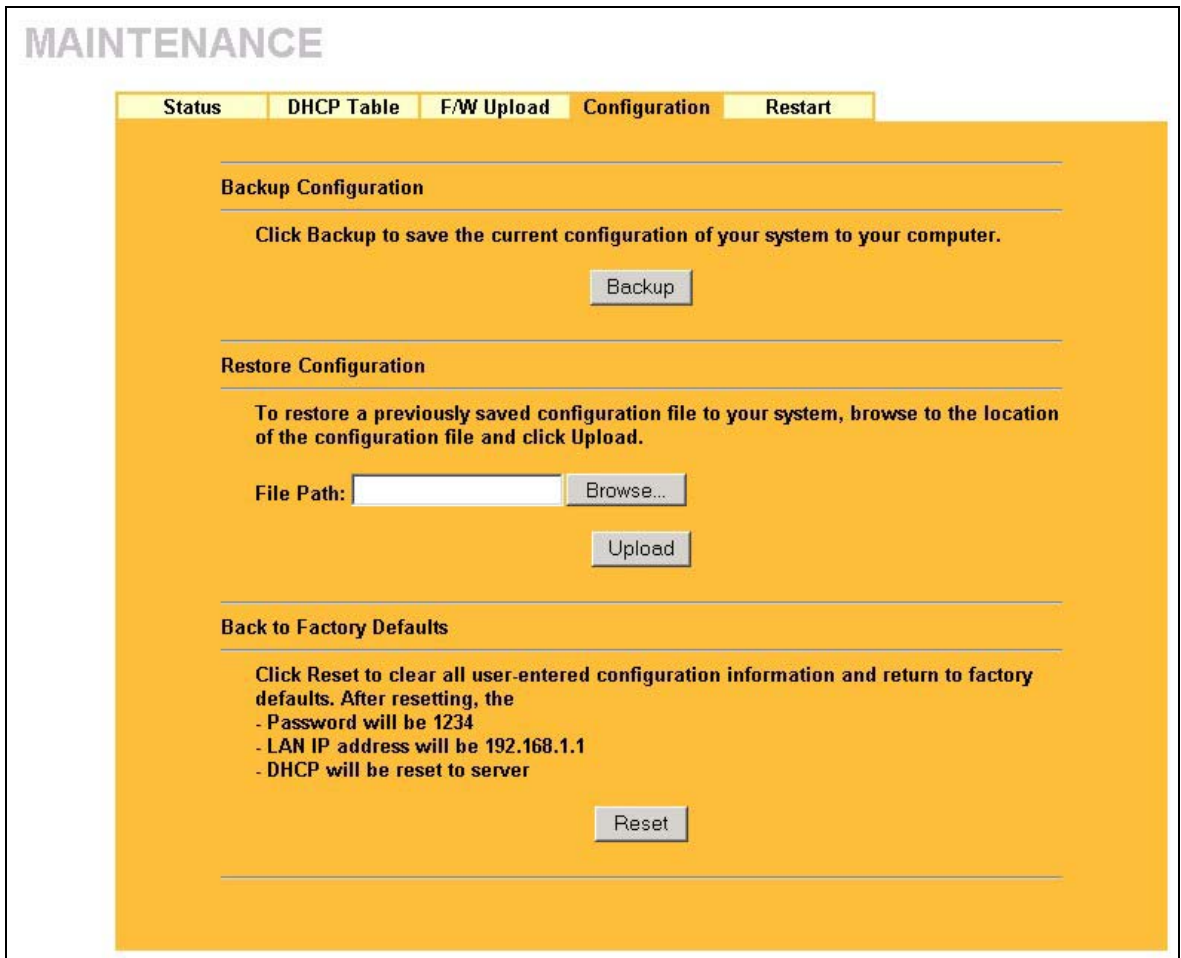

Figure 21-9 Configuration

21.5.1 Backup Configuration

Backup Configuration allows you to back up (save) the device's current configuration to a file on your computer. Once your device is configured and functioning properly, it is highly recommended that you back up your configuration file before making configuration changes. The backup configuration file will be useful in case you need to return to your previous settings.

Click **Backup** to save the device's current configuration to your computer.

21.5.2 Restore Configuration

Restore Configuration allows you to upload a new or previously saved configuration file from your computer to your ZyWALL.

Table 21-4 Restore Configuration

LABEL	DESCRIPTION
File Path	Type in the location of the file you want to upload in this field or click Browse ... to find it.
Browse...	Click Browse... to find the file you want to upload. Remember that you must decompress compressed (.ZIP) files before you can upload them.
Upload	Click Upload to begin the upload process.

Do not turn off the device while configuration file upload is in progress.

After you see a “configuration upload successful” screen, you must then wait one minute before logging into the device again.

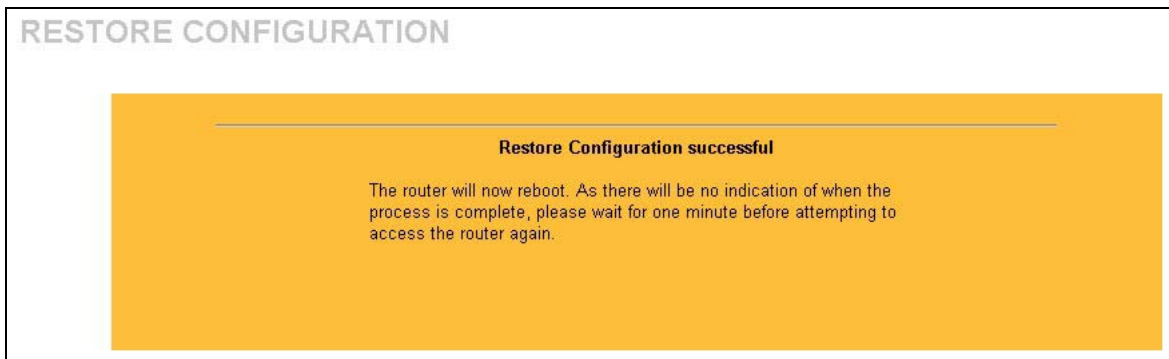

Figure 21-10 Configuration Upload Successful

The device automatically restarts in this time causing a temporary network disconnect. In some operating systems, you may see the following icon on your desktop.

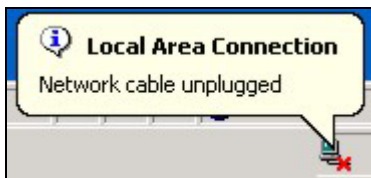

Figure 21-11 Network Temporarily Disconnected

If you uploaded the default configuration file you may need to change the IP address of your computer to be in the same subnet as that of the default device IP address (192.168.1.1). See your *Quick Start Guide* for details on how to set up your computer's IP address.

If the upload was not successful, the following screen will appear. Click **Return** to go back to the **Configuration** screen.

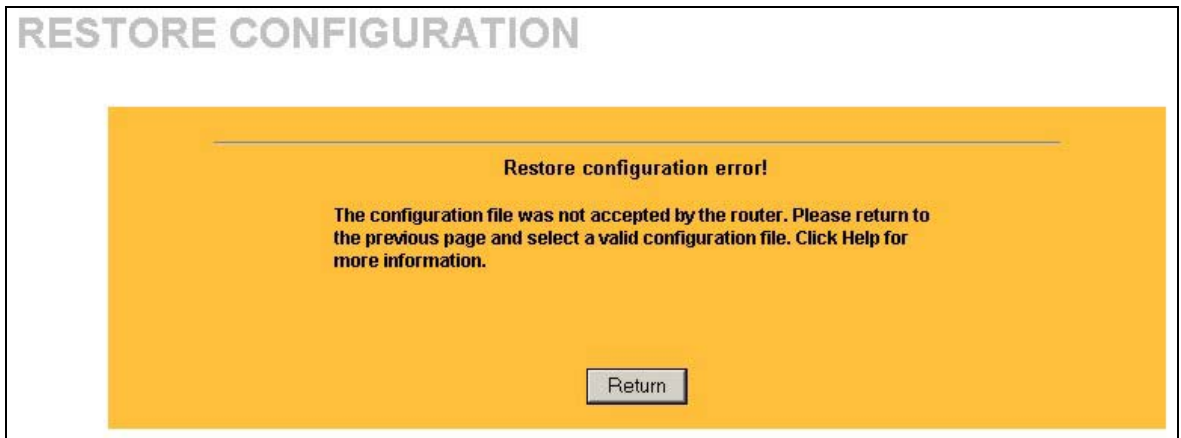

Figure 21-12 Configuration Upload Error

21.5.3 Back to Factory Defaults

Pressing the **Reset** button in this section clears all user-entered configuration information and returns the ZyWALL to its factory defaults as shown on the screen. The following warning screen will appear.

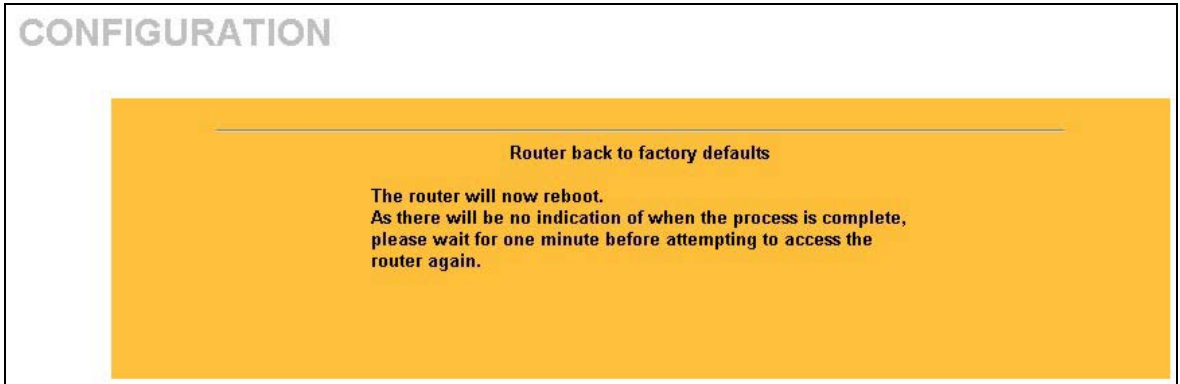

Figure 21-13 Reset Warning Message

You can also press the **RESET** button on the rear panel to reset the factory defaults of your ZyWALL. Refer to the *Introducing the Web Configurator* chapter for more information on the **RESET** button.

21.6 Restart Screen

System restart allows you to reboot the ZyWALL without turning the power off.

Click **MAINTENANCE**, and then **Restart**. Click **Restart** to have the ZyWALL reboot. This does not affect the ZyWALL's configuration.



Figure 21-14 Restart Screen

Part XI:

SMT General Configuration

This part introduces the System Management Terminal and covers the General setup menu, WAN and dial backup setup, LAN and wireless LAN setup, DMZ setup, and Internet access.

See the web configurator parts of this guide for background information on features configurable by web configurator and SMT.

Chapter 22

Introducing the SMT

This chapter explains how to access the System Management Terminal and gives an overview of its menus.

22.1 Introduction to the SMT

The ZyWALL's SMT (System Management Terminal) is a menu-driven interface that you can access from a terminal emulator through the console port or over a telnet connection. This chapter shows you how to access the SMT (System Management Terminal) menus via console port, how to navigate the SMT and how to configure SMT menus.

22.2 Accessing the SMT via the Console Port

Make sure you have the physical connection properly set up as described in the hardware installation chapter.

When configuring using the console port, you need a computer equipped with communications software configured to the following parameters:

- ◆ VT100 terminal emulation.
- ◆ 9600 Baud.
- ◆ No parity, 8 data bits, 1 stop bit, flow control set to none.

22.2.1 Initial Screen

When you turn on your ZyWALL, it performs several internal tests as well as line initialization.

After the tests, the ZyWALL asks you to press [ENTER] to continue, as shown next.

```
Copyright (c) 1994 - 2002 ZyXEL Communications Corp.  
initialize ch =0, ethernet address: 00:a0:c5:41:51:61  
initialize ch =1, ethernet address: 00:a0:c5:41:51:62  
Press ENTER to continue...
```

Figure 22-1 Initial Screen

22.2.2 Entering the Password

The login screen appears after you press [ENTER], prompting you to enter the password, as shown below.

For your first login, enter the default password “1234”. As you type the password, the screen displays an “X” for each character you type.

Please note that if there is no activity for longer than five minutes after you log in, your ZyWALL will automatically log you out and display a blank screen. If you see a blank screen, press [ENTER] to bring up the login screen again.



Figure 22-2 Password Screen

22.3 Navigating the SMT Interface

The SMT is an interface that you use to configure your ZyWALL.

Several operations that you should be familiar with before you attempt to modify the configuration are listed in the table below.

Table 22-1 Main Menu Commands

OPERATION	KEYSTROKES	DESCRIPTION
Move down to another menu	[ENTER]	To move forward to a submenu, type in the number of the desired submenu and press [ENTER].
Move up to a previous menu	[ESC]	Press the [ESC] key to move back to the previous menu.
Move to a “hidden” menu	Press [SPACE BAR] to change No to Yes then press [ENTER].	Fields beginning with “Edit” lead to hidden menus and have a default setting of No . Press [SPACE BAR] to change No to Yes , and then press [ENTER] to go to a “hidden” menu.
Move the cursor	[ENTER] or [UP]/[DOWN] arrow keys	Within a menu, press [ENTER] to move to the next field. You can also use the [UP]/[DOWN] arrow keys to move to the previous and the next field, respectively.

Table 22-1 Main Menu Commands

OPERATION	KEYSTROKES	DESCRIPTION
Entering information	Fill in, or press [SPACE BAR], then press [ENTER] to select from choices.	You need to fill in two types of fields. The first requires you to type in the appropriate information. The second allows you to cycle through the available choices by pressing [SPACE BAR].
Required fields	<? >	All fields with the symbol <?> must be filled in order be able to save the new configuration.
N/A fields	<N/A>	Some of the fields in the SMT will show a <N/A>. This symbol refers to an option that is Not Applicable.
Save your configuration	[ENTER]	Save your configuration by pressing [ENTER] at the message "Press ENTER to confirm or ESC to cancel". Saving the data on the screen will take you, in most cases to the previous menu.
Exit the SMT	Type 99, then press [ENTER].	Type 99 at the main menu prompt and press [ENTER] to exit the SMT interface.

22.3.1 Main Menu

After you enter the password, the SMT displays the **ZyWALL Main Menu**, as shown next. Not all models have all the features shown.

```

Copyright (c) 1994 - 2001 ZyXEL Communications Corp.

                ZyWALL 100 Main Menu

Getting Started                Advanced Management
 1. General Setup              21. Filter and Firewall Setup
 2. WAN Setup                  22. SNMP Configuration
 3. LAN Setup                  23. System Password
 4. Internet Access Setup     24. System Maintenance
 5. DMZ Setup                  25. IP Routing Policy
                               26. Schedule Setup
                               27. VPN/IPSec Setup

Advanced Applications
 11. Remote Node Setup
 12. Static Routing Setup
 15. NAT Setup

                               99. Exit

                Enter Menu Selection Number:

```

Figure 22-3 Main Menu (ZyWALL 100)

The following table describes the fields in this screen.

Table 22-2 Main Menu Summary

NO.	Menu Title	FUNCTION
1	General Setup	Use this menu to set up dynamic DNS and administrative information.
2	WAN Setup	Use this menu to clone a MAC address from a computer on your LAN and configure the backup WAN dial-up connection.
3	LAN Setup	Use this menu to apply LAN filters, configure LAN DHCP and TCP/IP settings and configure the wireless LAN port (not available on all models).
4	Internet Access Setup	Configure your Internet Access setup (Internet address, gateway, login, etc.) with this menu.
5	DMZ Setup (This feature is not available on all models.)	Use this menu to configure your public servers connected to the DMZ port.
11	Remote Node Setup	Use this menu to configure detailed remote node settings (your ISP is also a remote node) as well as apply WAN filters.
12	Static Routing Setup	Configure IP static routes in this menu.
15	NAT Setup	Use this menu to configure Network Address Translation.
21	Filter and Firewall Setup	Configure filters, activate/deactivate the firewall and view the firewall log.
22	SNMP Configuration	Use this menu to configure SNMP-related parameters.
23	System Password	Change your password in this menu (recommended).
24	System Maintenance	From displaying system status to uploading firmware, this menu provides comprehensive system maintenance.
25	IP Routing Policy Setup	Use this menu to configure policies for use in IP policy routing.
26	Schedule Setup	Use this menu to schedule outgoing calls.
27	VPN /IPSec Setup	Use this menu to configure VPN connections.
99	Exit	Use this menu to exit (necessary for remote configuration).

22.3.2 SMT Menus at a Glance

The available SMT screens vary by ZyWALL model. The following SMT overview applies to the ZyWALL 100.

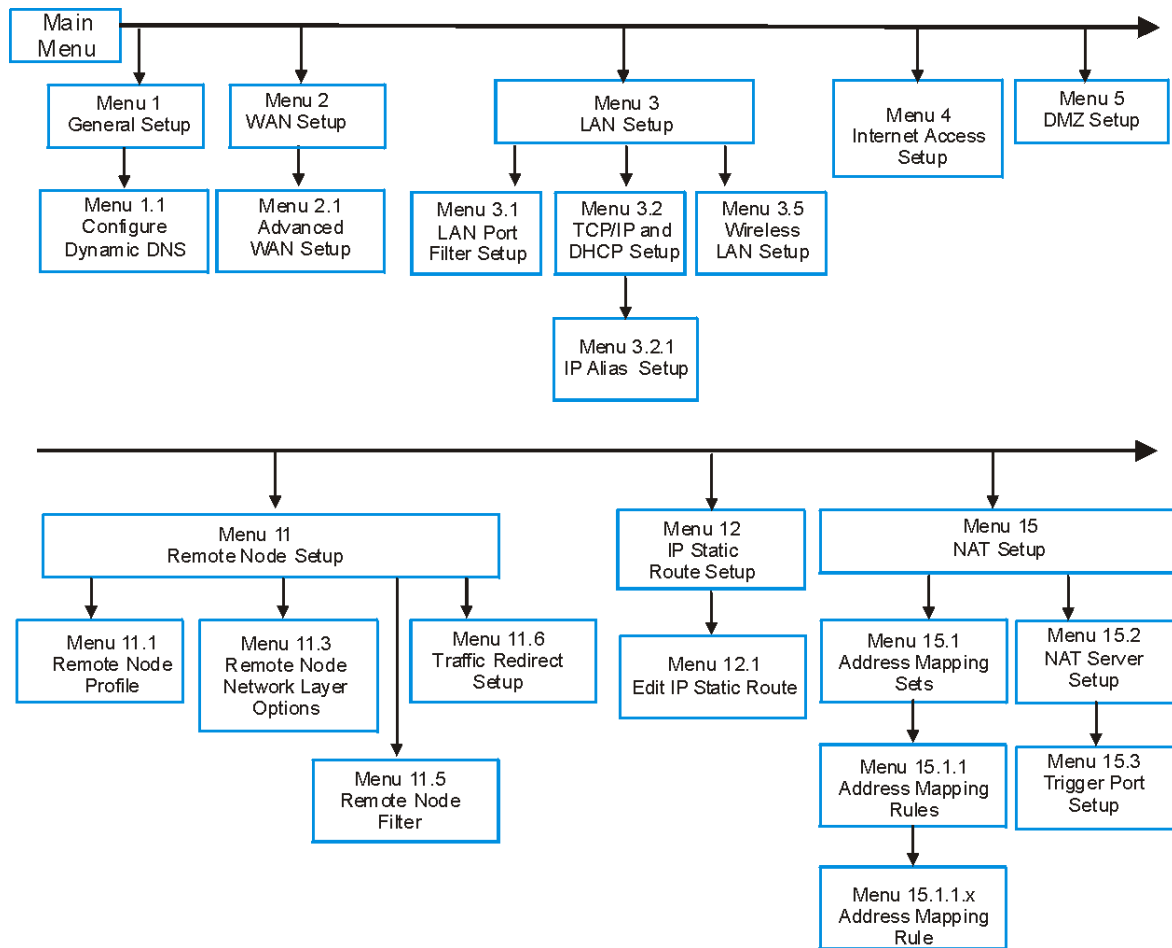

Figure 22-4 Getting Started and Advanced Applications SMT Menus

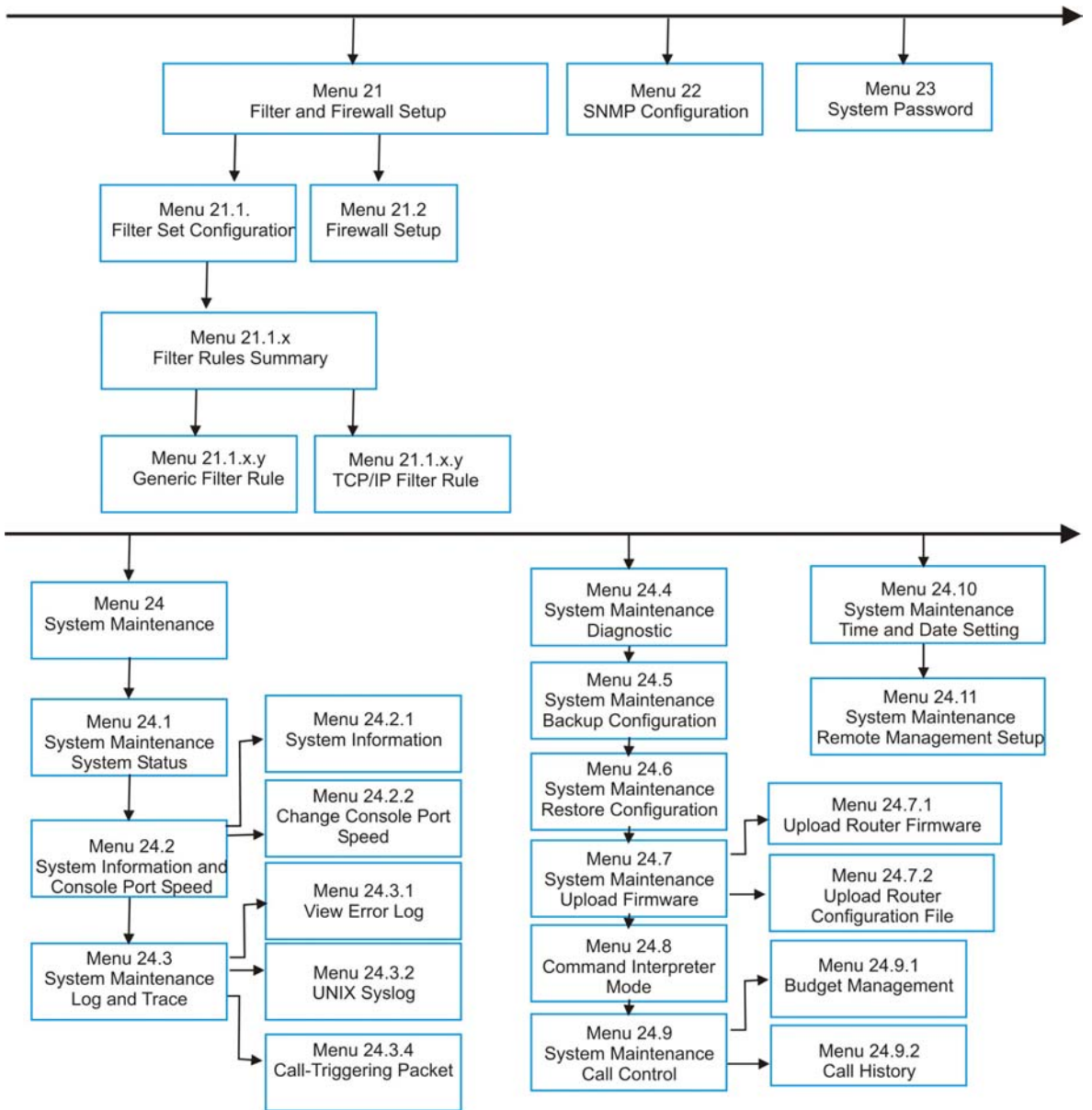

Figure 22-5 Advanced Management SMT Menus

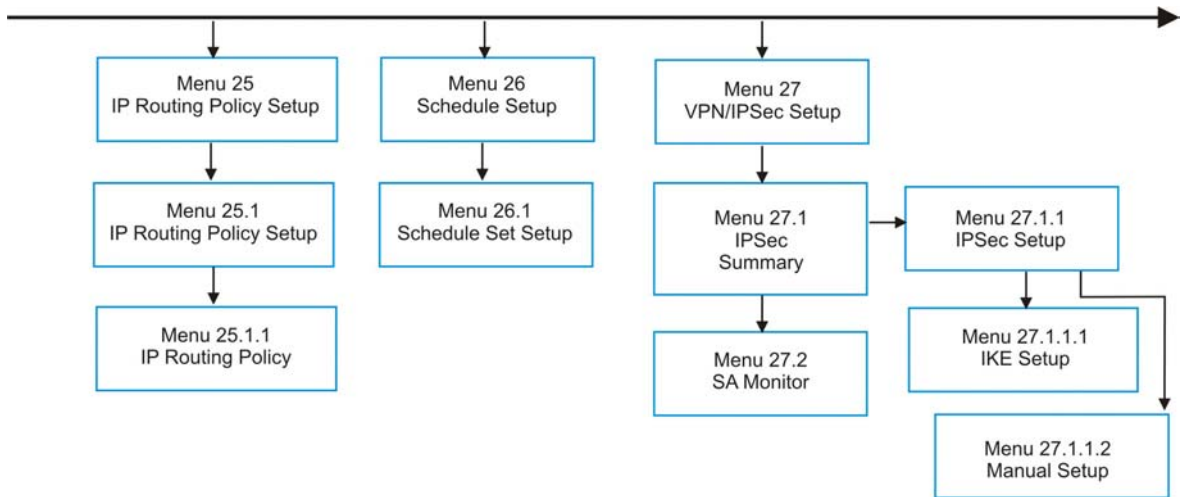

Figure 22-6 Schedule Setup and IPsec VPN Configuration SMT Menus

22.4 Changing the System Password

Change the system password by following the steps shown next.

```

Menu 23 - System Password

Old Password= ?
New Password= ?
Retype to confirm= ?

Enter here to CONFIRM or ESC to CANCEL:
  
```

Step 1. Enter 23 in the main menu to open **Menu 23 - System Password** as shown next.

Figure 22-7 Menu 23: System Password

Step 2. Type your existing password and press [ENTER].

Step 3. Type your new system password and press [ENTER].

Step 4. Re-type your new system password for confirmation and press [ENTER].

Note that as you type a password, the screen displays an “X” for each character you type.

22.5 Resetting the ZyWALL

If you forget your password or cannot access the SMT menu, refer to the section on resetting the ZyWALL in the web configurator part of this guide.

Chapter 23

SMT Menu 1 - General Setup

Menu 1 - General Setup contains administrative and system-related information.

23.1 Introduction to General Setup

Menu 1 - General Setup contains administrative and system-related information.

23.2 Configuring General Setup

Step 1. Enter 1 in the main menu to open **Menu 1: General Setup**.

Step 2. The **Menu 1 - General Setup** screen appears, as shown next. Fill in the required fields.

```
Menu 1 - General Setup

System Name=
Domain Name=
First System DNS Server= From ISP
  IP Address= N/A
Second System DNS Server= None
  IP Address= N/A
Third System DNS Server= None
  IP Address= N/A
Edit Dynamic DNS= No

Press ENTER to Confirm or ESC to Cancel:
```

Figure 23-1 Menu 1: General Setup (ZyWALL 10W)

The following table describes the fields in this screen.

Table 23-1 General Setup Menu Field

FIELD	DESCRIPTION	EXAMPLE
System Name	Choose a descriptive name for identification purposes. It is recommended you enter your computer's "Computer name" in this field. This name can be up to 30 alphanumeric characters long. Spaces are not allowed, but dashes "-" and underscores "_" are accepted.	ZyWALL
Domain Name	Enter the domain name (if you know it) here. If you leave this field blank, the ISP may assign a domain name via DHCP. You can go to menu 24.8 and type "sys domain name" to see the current domain name used by your router. The domain name entered by you is given priority over the ISP assigned domain name. If you want to clear this field just press [SPACE BAR] and then [ENTER].	zyxel.com.tw
First System DNS Server Second System DNS Server Third System DNS Server	DNS (Domain Name System) is for mapping a domain name to its corresponding IP address and vice versa. The DNS server is extremely important because without it, you must know the IP address of a machine before you can access it. The ZyWALL uses a system DNS server (in the order you specify here) to resolve domain names for VPN, DDNS and the time server. Press [SPACE BAR] and then [ENTER] to select an option. Select From ISP if your ISP dynamically assigns DNS server information (and the ZyWALL's WAN IP address). The IP Address field below displays the (read-only) DNS server IP address that the ISP assigns. Select User-Defined if you have the IP address of a DNS server. Enter the DNS server's IP address in the field to the right. If you select User-Defined , but leave the IP address set to 0.0.0.0, User-Defined changes to None after you save your changes. If you set a second choice to User-Defined , and enter the same IP address, the second User-Defined changes to None after you save your changes. Select None if you do not want to configure DNS servers. If you do not configure a system DNS server, you must use IP addresses when configuring VPN, DDNS and the time server.	
Edit Dynamic DNS	Press [SPACE BAR] and then [ENTER] to select Yes or No (default). Select Yes to configure Menu 1.1: Configure Dynamic DNS discussed next.	No (default)
When you have completed this menu, press [ENTER] at the prompt "Press ENTER to Confirm..." to save your configuration, or press [ESC] at any time to cancel.		

23.2.1 Configuring Dynamic DNS

To configure Dynamic DNS, go to **Menu 1: General Setup** and press [SPACE BAR] to select **Yes** in the **Edit Dynamic DNS** field. Press [ENTER] to display **Menu 1.1— Configure Dynamic DNS** (shown next). Not all models have every field shown.

```

Menu 1.1 - Configure Dynamic DNS

Service Provider= WWW.DynDNS.ORG
Active= Yes
DDNSType= DynamicDNS
Host1=
Host2=
Host3=
EMAIL=
USER=
Password= *****
Enable Wildcard= No
Offline= N/A
Edit Update IP Address:
  Use Server Detected IP= Yes
  User Specified IP Address=No
  IP Address=N/A

Press ENTER to confirm or ESC to cancel:

```

Figure 23-2 Configure Dynamic DNS

Follow the instructions in the next table to configure Dynamic DNS parameters.

Table 23-2 Configure Dynamic DNS

FIELD	DESCRIPTION	EXAMPLE
Service Provider	This is the name of your Dynamic DNS service provider.	WWW.DynDNS.ORG (default)
Active	Press [SPACE BAR] to select Yes and then press [ENTER] to make dynamic DNS active.	Yes
DDNS Type	Press [SPACE BAR] and then [ENTER] to select DynamicDNS if you have a dynamic IP address(es). Select StaticDNS if you have a static IP address(s). Select CustomDNS to have dyns.org provide DNS service for a domain name that you already have from a source other than dyndns.org.	DynamicDNS (default)
Host1-3	Enter your host name(s) in the fields provided. You can specify up to two host names separated by a comma in each field.	me.dyndns.org
EMAIL	Enter your e-mail address.	mail@mailserver

Table 23-2 Configure Dynamic DNS

FIELD	DESCRIPTION	EXAMPLE
USER	Enter your user name.	
Password	Enter the password assigned to you.	
Enable Wildcard	Your ZyWALL supports DYNDNS Wildcard. Press [SPACE BAR] and then [ENTER] to select Yes or No . This field is N/A when you choose DDNS client as your service provider.	No
Offline	This field is only available when CustomDNS is selected in the DDNS Type field. Press [SPACE BAR] and then [ENTER] to select Yes . When Yes is selected, http://www.dyndns.org/traffic is redirected to a URL that you have previously specified (see www.dyndns.org for details).	Yes
<p>Edit Update IP Address:</p> <p>You can select Yes in either the Use Server Detected IP field (recommended) or the User Specified IP Addr field, but not both.</p> <p>With the Use Server Detected IP and User Specified IP Addr fields both set to No, the DDNS server automatically updates the IP address of the host name(s) with the ZyWALL's WAN IP address.</p> <p>DDNS does not work with a private IP address. When both fields are set to No, the ZyWALL must have a public WAN IP address in order for DDNS to work.</p>		
Use Server Detected IP	<p>Press [SPACE BAR] to select Yes and then press [ENTER] to have the DDNS server automatically update the IP address of the host name(s) with the public IP address that the ZyWALL uses or is behind.</p> <p>You can set this field to Yes whether the IP address is public or private, static or dynamic.</p>	Yes
User Specified IP Address	<p>Press [SPACE BAR] to select Yes and then press [ENTER] to update the IP address of the host name(s) to the IP address specified below.</p> <p>Only select Yes if the ZyWALL uses or is behind a static public IP address.</p>	No
IP Address	Enter the static public IP address if you select Yes in the User Specified IP Addr field.	N/A
<p>When you have completed this menu, press [ENTER] at the prompt "Press ENTER to Confirm..." to save your configuration, or press [ESC] at any time to cancel.</p>		

The IP address updates when you reconfigure menu 1 or perform DHCP client renewal.

Chapter 24

WAN and Dial Backup Setup

This chapter describes how to configure the WAN using menu 2 and dial-backup using menus 2.1 and 11.1.

24.1 Introduction to WAN and Dial Backup Setup

This chapter explains how to configure settings for your WAN port and how to configure the ZyWALL for a dial backup connection.

24.2 WAN Setup

From the main menu, enter 2 to open menu 2.

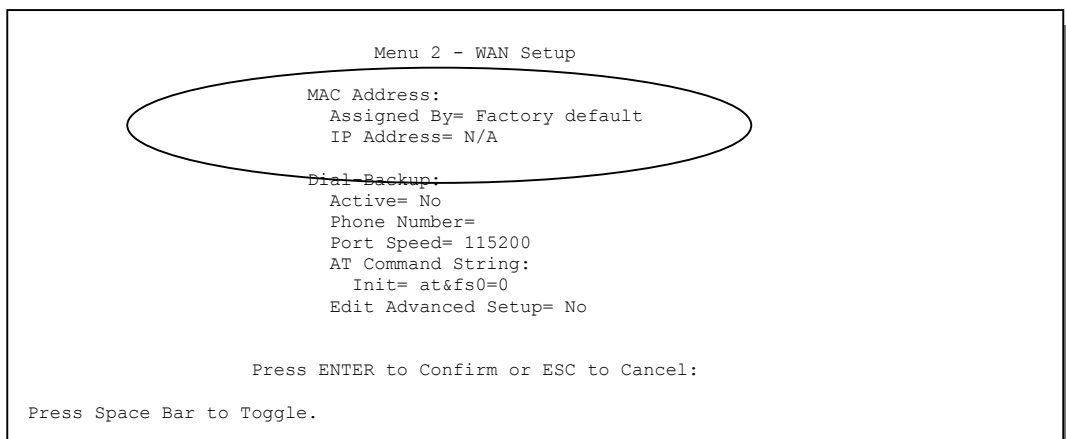

Figure 24-1 MAC Address Cloning in WAN Setup

The following table describes the fields in this screen.

Table 24-1 MAC Address Cloning in WAN Setup

FIELD	DESCRIPTION	EXAMPLE
MAC Address		
Assigned By	Press [SPACE BAR] and then [ENTER] to choose one of two methods to assign a MAC Address. Choose Factory Default to select the factory assigned default MAC Address. Choose IP address attached on LAN to use the MAC Address of that workstation whose IP you give in the following field.	IP address attached on LAN
IP Address	This field is applicable only if you choose the IP address attached on LAN method in the Assigned By field. Enter the IP address of the computer on the LAN whose MAC you are cloning.	192.168.1.35
When you have completed this menu, press [ENTER] at the prompt "Press ENTER to Confirm..." to save your configuration, or press [ESC] at any time to cancel.		

24.3 Dial Backup

The Dial Backup port or CON/AUX port can be used in reserve, as a traditional dial-up connection should the broadband connection to the WAN port fail. This feature is not available on all models. To set up the auxiliary port (Dial Backup or CON/AUX) for use in the event that the regular WAN connection is dropped, first make sure you have set up the switch and port connection (see the Hardware Installation chapter), then configure

1. Menu 2 - WAN Setup,
2. Menu 2.1 - Advanced WAN Setup and
3. Menu 11.1 - Remote Node Profile (Backup ISP) as shown next

Refer also to the traffic redirect section for information on an alternate backup WAN connection.

24.4 Configuring Dial Backup in Menu 2

From the main menu, enter 2 to open menu 2.

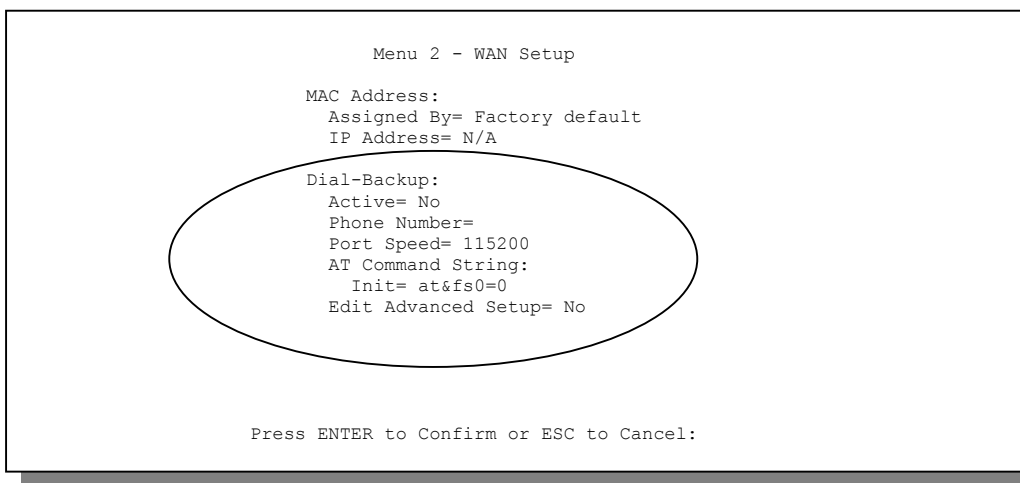

Figure 24-2 Menu 2: Dial Backup Setup

The following table describes the fields in this screen.

Table 24-2 Menu 2: Dial Backup Setup

FIELD	DESCRIPTION	EXAMPLE
Dial-Backup:		
Active	Use this field to turn the dial-backup feature on (Yes) or off (No).	No
Phone Number	Enter the telephone number assigned to your line by your telephone company. This field only accepts digits; do not include dashes and spaces.	1234567
Port Speed	Press [SPACE BAR] and then press [ENTER] to select the speed of the connection between the Dial Backup port and the external device. Available speeds are: 9600, 19200, 38400, 57600, 115200 or 230400 bps.	115200
AT Command String:		
Init	Enter the AT command string to initialize the WAN device. Consult the manual of your WAN device connected to your Dial Backup port for specific AT commands.	at&fs0=0

Table 24-2 Menu 2: Dial Backup Setup

FIELD	DESCRIPTION	EXAMPLE
Edit Advanced Setup	To edit the advanced setup for the Dial Backup port, move the cursor to this field; press the [SPACE BAR] to select Yes and then press [ENTER] to go to Menu 2.1: Advanced Setup .	Yes
When you have completed this menu, press [ENTER] at the prompt "Press ENTER to Confirm..." to save your configuration, or press [ESC] at any time to cancel.		

24.5 Advanced WAN Setup

Consult the manual of your WAN device connected to your Dial Backup port for specific AT commands.

To edit the advanced setup for the Dial Backup port, move the cursor to the **Edit Advanced Setup** field in **Menu 2 - WAN Setup**, press the [SPACE BAR] to select **Yes** and then press [ENTER].

```

Menu 2.1 - Advanced WAN Setup

AT Command Strings:
Dial= atdt
Drop= ~*~*~*~*ath
Answer= ata

Drop DTR When Hang Up= Yes

AT Response Strings:
CLID= NMBR =
Called Id=
Speed= CONNECT

Call Control:
Dial Timeout(sec)= 60
Retry Count= 0
Retry Interval(sec)= N/A
Drop Timeout(sec)= 20
Call Back Delay(sec)= 15

Press ENTER to Confirm or ESC to Cancel:
    
```

Figure 24-3 Menu 2.1 Advanced WAN Setup

The following table describes fields in this menu.

Table 24-3 Advanced WAN Port Setup: AT Commands Fields

FIELD	DESCRIPTION	DEFAULT
AT Command Strings:		

Table 24-3 Advanced WAN Port Setup: AT Commands Fields

FIELD	DESCRIPTION	DEFAULT
Dial	Enter the AT Command string to make a call.	atdt
Drop	Enter the AT Command string to drop a call. “~” represents a one second wait, e.g., “~~~+++~ath” can be used if your modem has a slow response time.	+++ath
Answer	Enter the AT Command string to answer a call.	ata
Drop DTR When Hang Up	Press the [SPACE BAR] to choose either Yes or No . When Yes is selected (the default), the DTR (Data Terminal Ready) signal is dropped after the “AT Command String: Drop” is sent out.	Yes
AT Response String:		
CLID (Calling Line Identification)	Enter the keyword that precedes the CLID (Calling Line Identification) in the AT response string. This lets the ZyWALL capture the CLID in the AT response string that comes from the WAN device. CLID is required for CLID authentication.	NMBR =
Called Id	Enter the keyword preceding the dialed number.	TO
Speed	Enter the keyword preceding the connection speed.	CONNECT

Table 24-4 Advanced WAN Port Setup: Call Control Parameters

FIELD	DESCRIPTION	DEFAULT
Call Control		
Dial Timeout (sec)	Enter a number of seconds for the ZyWALL to keep trying to set up an outgoing call before timing out (stopping). The ZyWALL times out and stops if it cannot set up an outgoing call within the timeout value.	60 seconds
Retry Count	Enter a number of times for the ZyWALL to retry a busy or no-answer phone number before blacklisting the number.	0 to disable the blacklist control
Retry Interval (sec)	Enter a number of seconds for the ZyWALL to wait before trying another call after a call has failed. This applies before a phone number is blacklisted.	

Table 24-4 Advanced WAN Port Setup: Call Control Parameters

FIELD	DESCRIPTION	DEFAULT
Drop Timeout (sec)	Enter a number of seconds for the ZyWALL to wait before dropping the DTR signal if it does not receive a positive disconnect confirmation.	20 seconds
Call Back Delay (sec)	Enter a number of seconds for the ZyWALL to wait between dropping a callback request call and dialing the co-responding callback call.	15 seconds

24.6 Remote Node Profile (Backup ISP)

Enter **2** in **Menu 11 Remote Node Setup** to open **Menu 11.1 Remote Node Profile (Backup ISP)** (shown below) and configure the setup for your Dial Backup port connection. This feature is not available on all models.

```

Menu 11.1 - Remote Node Profile (Backup ISP)

Rem Node Name= ?                Edit PPP Options= No
Active= Yes                      Rem IP Addr= 0.0.0.0
                                  Edit IP= No
Outgoing:                        Edit Script Options= No
  My Login=
  My Password= *****
  Authen= CHAP/PAP              Telco Option:
  Pri Phone #= ?                Allocated Budget(min)= 0
  Sec Phone #=                  Period(hr)= 0
                                  Nailed-Up Connection= No

                                  Session Options:
                                  Edit Filter Sets= No
                                  Idle Timeout(sec)= 100

Press ENTER to Confirm or ESC to Cancel:

```

Figure 24-4 Menu 11.1 Remote Node Profile (Backup ISP)

The following table describes the fields in this screen.

Table 24-5 Fields in Menu 11.1 Remote Node Profile (Backup ISP)

FIELD	DESCRIPTION	EXAMPLE
Rem Node Name	Enter a descriptive name for the remote node. This field can be up to eight characters.	LAoffice

Table 24-5 Fields in Menu 11.1 Remote Node Profile (Backup ISP)

FIELD	DESCRIPTION	EXAMPLE
Active	Press [SPACE BAR] and then [ENTER] to select Yes to enable the remote node or No to disable the remote node.	Yes
Outgoing		
My Login	Enter the login name assigned by your ISP for this remote node.	jim
My Password	Enter the password assigned by your ISP for this remote node.	*****
Authen	This field sets the authentication protocol used for outgoing calls. Options for this field are: CHAP/PAP - Your ZyWALL will accept either CHAP or PAP when requested by this remote node. CHAP - accept CHAP only. PAP - accept PAP only.	CHAP/PAP
Pri Phone # Sec Phone #	Enter the first (primary) phone number from the ISP for this remote node. If the Primary Phone number is busy or does not answer, your ZyWALL dials the Secondary Phone number if available. Some areas require dialing the pound sign # before the phone number for local calls. Include a # symbol at the beginning of the phone numbers as required.	
Edit PPP Options	Move the cursor to this field and use the space bar to select [Yes] and press [Enter] to edit the PPP options for this remote node. This brings you to Menu 11.2 - Remote Node PPP Options (see <i>section 24.7</i>).	No (default)
Rem IP Addr	Leave the field set to 0.0.0.0 (default) if the remote gateway has a dynamic IP address. Enter the remote gateway's IP address here if it is static.	0.0.0.0 (default)
Edit IP	This field leads to a "hidden" menu. Press [SPACE BAR] to select Yes and press [ENTER] to go to Menu 11.3 - Remote Node Network Layer Options . See <i>section 24.8</i> for more information.	No (default)
Edit Script Options	Press [SPACE BAR] to select Yes and press [ENTER] to edit the AT script for the dial backup remote node (Menu 11.4 - Remote Node Script). See <i>section 24.9</i> for more information.	No (default)
Telco Option		

Table 24-5 Fields in Menu 11.1 Remote Node Profile (Backup ISP)

FIELD	DESCRIPTION	EXAMPLE
Allocated Budget	Enter the maximum number of minutes that this remote node may be called within the time period configured in the Period field. The default for this field is 0 meaning there is no budget control and no time limit for accessing this remote node.	0 (default)
Period(hr)	Enter the time period (in hours) for how often the budget should be reset. For example, to allow calls to this remote node for a maximum of 10 minutes every hour, set the Allocated Budget to 10 (minutes) and the Period to 1 (hour).	0 (default)
Nailed-Up Connection	Press [SPACE BAR] to select Yes to set this connection to always be on, regardless of whether or not there is any traffic. Select No to have this connection act as a dial-up connection.	No (default)
Session Options		
Edit Filter sets	This field leads to another “hidden” menu. Use [SPACE BAR] to select Yes and press [ENTER] to open menu 11.5 to edit the filter sets. See <i>section 24.10</i> for more details.	No (default)
Idle Timeout	Enter the number of seconds of idle time (when there is no traffic from the ZyWALL to the remote node) that can elapse before the ZyWALL automatically disconnects the PPP connection. This option only applies when the ZyWALL initiates the call.	100 seconds (default)
Once you have configured this menu, press [ENTER] at the message “Press ENTER to Confirm...” to save your configuration, or press [ESC] at any time to cancel.		

24.7 Editing PPP Options

The ZyWALL’s dial back-up feature uses PPP. To edit the remote node PPP Options, move the cursor to the **[Edit PPP Options]** field in Menu 11.1 - Remote Node Profile, and use the space bar to select **[Yes]**. Press [ENTER] to open Menu 11.2 as shown next.

```

Menu 11.2 - Remote Node PPP Options

Encapsulation= Standard PPP
Compression= No

Enter here to CONFIRM or ESC to CANCEL:

Press Space Bar to Toggle.

```

Figure 24-5 Menu 11.2: Remote Node PPP Options

This table describes the Remote Node PPP Options Menu, and contains instructions on how to configure the PPP options fields.

Table 24-6 Remote Node PPP Options Menu Fields

FIELD	DESCRIPTION	EXAMPLE
Encapsulation	Press [SPACE BAR] and then [ENTER] to select CISCO PPP if your Dial Backup WAN device uses Cisco PPP encapsulation, otherwise select Standard PPP .	Standard PPP (default)
Compression	Press [SPACE BAR] and then [ENTER] to select Yes to enable or No to disable Stac compression.	No (default)

24.8 Editing TCP/IP Options

Move the cursor to the **Edit IP** field in menu 11.1, then press [SPACE BAR] to select **Yes**. Press [ENTER] to open **Menu 11.3 - Network Layer Options**.

```

Menu 11.3 - Remote Node Network Layer Options

Rem IP Addr= 0.0.0.0
Rem Subnet Mask= 0.0.0.0
My WAN Addr= 0.0.0.0

Network Address Translation= None
Metric= 15
Private= No
RIP Direction= Both
Version= RIP-2B
Multicast= None

Enter here to CONFIRM or ESC to CANCEL:

```

Figure 24-6 Menu 11.3: Remote Node Network Layer Options

The following table describes the fields in this screen.

Table 24-7 Remote Node Network Layer Options Menu Fields

FIELD	DESCRIPTION	EXAMPLE
Rem IP Address	Leave this field set to 0.0.0.0 to have the ISP or other remote router dynamically (automatically) send its IP address if you do not know it. Enter the remote gateway's IP address here if you know it (static).	0.0.0.0 (default)
Rem Subnet Mask	Leave this field set to 0.0.0.0 to have the ISP or other remote router dynamically send its subnet mask if you do not know it. Enter the remote gateway's subnet mask here if you know it (static).	0.0.0.0 (default)
My WAN Addr	Leave the field set to 0.0.0.0 to have the ISP or other remote router dynamically (automatically) assign your WAN IP address if you do not know it. Enter your WAN IP address here if you know it (static). This is the address assigned to your local ZyWALL, not the remote router.	0.0.0.0 (default)
Network Address Translation	Network Address Translation (NAT) allows the translation of an Internet protocol address used within one network (for example a private IP address used in a local network) to a different IP address known within another network (for example a public IP address used on the Internet). Press [SPACE BAR] and then [ENTER] to select either Full Feature , None or SUA Only . Choose None to disable NAT. Choose SUA Only if you have a single public IP address. SUA (Single User Account) is a subset of NAT that supports two types of mapping: Many-to-One and Server . Choose Full Feature if you have multiple public IP addresses. Full Feature mapping types include: One-to-One , Many-to-One (SUA/PAT), Many-to-Many Overload , Many- One-to-One and Server . When you select Full Feature you must configure at least one address mapping set! See the Network Address Translation (NAT) chapter for a full discussion on this feature.	None (default)
Metric	Enter a number from 1 to 15 to set this route's priority among the ZyWALL's routes. The smaller the number, the higher priority the route has.	15 (default)
Private	This parameter determines if the ZyWALL will include the route to this remote node in its RIP broadcasts. If set to Yes , this route is kept private and not included in RIP broadcasts. If No , the route to this remote node will be propagated to other hosts through RIP broadcasts.	No (default)

Table 24-7 Remote Node Network Layer Options Menu Fields

FIELD	DESCRIPTION	EXAMPLE
RIP Direction	Press [SPACE BAR] and then [ENTER] to select the RIP direction from Both/ None/In Only/Out Only and None .	Both (default)
Version	Press [SPACE BAR] and then [ENTER] to select the RIP version from RIP-1/RIP-2B/RIP-2M .	RIP-1
Multicast	IGMP (Internet Group Multicast Protocol) is a network-layer protocol used to establish membership in a Multicast group. The ZyWALL supports both IGMP version 1 (IGMP-v1) and version 2 (IGMP-v2). Press the [SPACE BAR] to enable IP Multicasting or select None to disable it. See the LAN Setup chapter for more information on this feature.	None (default)
Once you have completed filling in Menu 11.3 Remote Node Network Layer Options , press [ENTER] at the message "Press ENTER to Confirm..." to save your configuration and return to menu 11, or press [ESC] at any time to cancel.		

24.9 Editing Login Script

For some remote gateways, text login is required before PPP negotiation is started. The ZyWALL provides a script facility for this purpose. The script has six programmable sets; each set is composed of an 'Expect' string and a 'Send' string. After matching a message from the server to the 'Expect' field, the ZyWALL returns the set's 'Send' string to the server.

For instance, a typical login sequence starts with the server printing a banner, a login prompt for you to enter the user name and a password prompt to enter the password:

```
Welcome to Acme, Inc.
```

```
Login: myLogin
```

```
Password:
```

To handle the first prompt, you specify "ogin: " as the 'Expect' string and "myLogin" as the 'Send' string in set 1. The reason for leaving out the leading "L" is to avoid having to know exactly whether it is upper or lower case. Similarly, you specify "word: " as the 'Expect' string and your password as the 'Send' string for the second prompt in set 2.

You can use two variables, \$USERNAME and \$PASSWORD (all UPPER case), to represent the actual user name and password in the script, so they will not show in the clear. They are replaced with the outgoing login name and password in the remote node when the ZyWALL sees them in a 'Send' string. Please note that both variables must be entered exactly as shown. No other characters may appear before or after, either, i.e., they must be used alone in response to login and password prompts.

Please note that the ordering of the sets is significant, i.e., starting from set 1, the ZyWALL will wait until the ‘Expect’ string is matched before it proceeds to set 2, and so on for the rest of the script. When both the ‘Expect’ and the ‘Send’ fields of the current set are empty, the ZyWALL will terminate the script processing and start PPP negotiation. This implies two things: first, the sets must be contiguous; the sets after an empty one are ignored. Second, the last set should match the final message sent by the server. For instance, if the server prints:

```
login successful.  
Starting PPP...
```

after you enter the password, then you should create a third set to match the final “PPP . . .” but without a “Send” string. Otherwise, the ZyWALL will start PPP prematurely right after sending your password to the server.

If there are errors in the script and it gets stuck at a set for longer than the “Dial Timeout” in menu 2 (default 60 seconds), the ZyWALL will timeout and drop the line. To debug a script, go to Menu 24.4 to initiate a manual call and watch the trace display to see if the sequence of messages and prompts from the server differs from what you expect.

```
Menu 11.4 - Remote Node Script  
  
Active= No  
  
Set 1:                               Set 5:  
  Expect=                             Expect=  
  Send=                               Send=  
Set 2:                               Set 6:  
  Expect=                             Expect=  
  Send=                               Send=  
Set 3:  
  Expect=  
  Send=  
Set 4:  
  Expect=  
  Send=  
  
Enter here to CONFIRM or ESC to CANCEL:
```

Figure 24-7 Menu 11.4: Remote Node Setup Script

The following table describes the fields in this screen.

Table 24-8 Menu 11.4: Remote Node Script Menu Fields

FIELD	DESCRIPTION	EXAMPLE
Active	Press [SPACE BAR] and then [ENTER] to select either Yes to enable the AT strings or No to disable them.	No (default)
Set 1-6: Expect	Enter an Expect string to match. After matching the Expect string, the ZyWALL returns the string in the Send field.	
Set 1-6: Send	Enter a string to send out after the Expect string is matched.	0.0.0.0

24.10 Remote Node Filter

Move the cursor to the field **Edit Filter Sets** in menu 11.1, and then press [SPACE BAR] to set the value to **Yes**. Press [ENTER] to open **Menu 11.5 - Remote Node Filter**.

Use menu 11.5 to specify the filter set(s) to apply to the incoming and outgoing traffic between this remote node and the ZyWALL to prevent certain packets from triggering calls. You can specify up to four filter sets separated by commas, for example, 1, 5, 9, 12, in each filter field. Note that spaces are accepted in this field. Please refer to the *Filters* chapter for more information on defining the filters.

```

Menu 11.5 - Remote Node Filter

Input Filter Sets:
  protocol filters=
  device filters=
Output Filter Sets:
  protocol filters=
  device filters=
Call Filter Sets:
  protocol filters=
  device filters=

Enter here to CONFIRM or ESC to CANCEL:

```

Figure 24-8 Menu 11.5: Dial Backup Remote Node Filter

Chapter 25

LAN Setup

*This chapter describes how to configure the LAN using **Menu 3: LAN Setup**.*

25.1 Introduction to LAN Setup

This chapter describes how to configure the ZyWALL for LAN and wireless LAN connections.

25.2 Accessing the LAN Menus

From the main menu, enter 3 to open **Menu 3 – LAN Setup**.

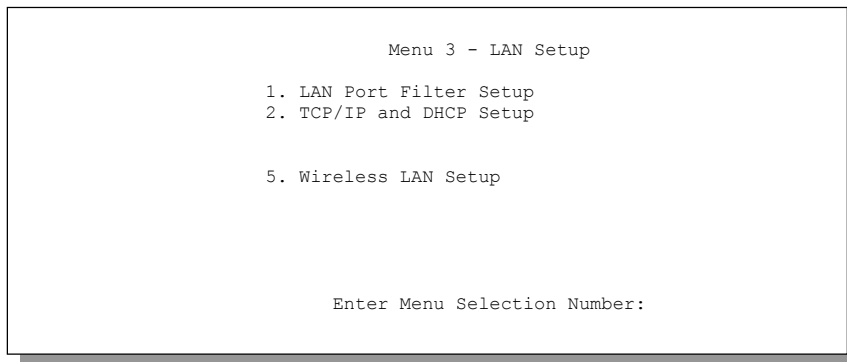

Figure 25-1 Menu 3: LAN Setup

25.3 LAN Port Filter Setup

This menu allows you to specify the filter sets that you wish to apply to the LAN traffic. You seldom need to filter the LAN traffic, however, the filter sets may be useful to block certain packets, reduce traffic and prevent security breaches.

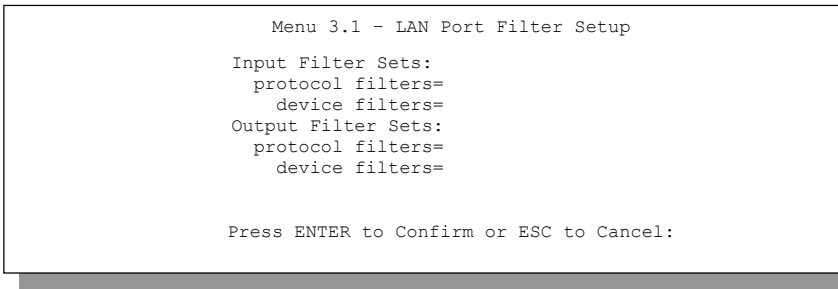

Figure 25-2 Menu 3.1: LAN Port Filter Setup

25.4 TCP/IP and DHCP Ethernet Setup Menu

From the main menu, enter 3 to open **Menu 3 - LAN Setup** to configure TCP/IP (RFC 1155) and DHCP Ethernet setup.

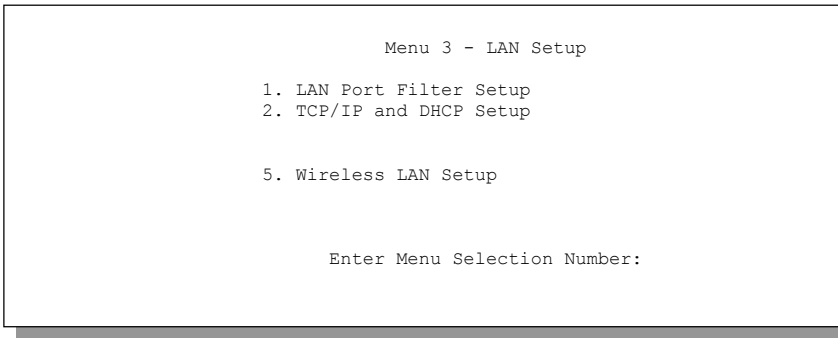

Figure 25-3 Menu 3: TCP/IP and DHCP Setup

From menu 3, select the submenu option **TCP/IP and DHCP Setup** and press [ENTER]. The screen now displays **Menu 3.2: TCP/IP and DHCP Ethernet Setup**, as shown next.

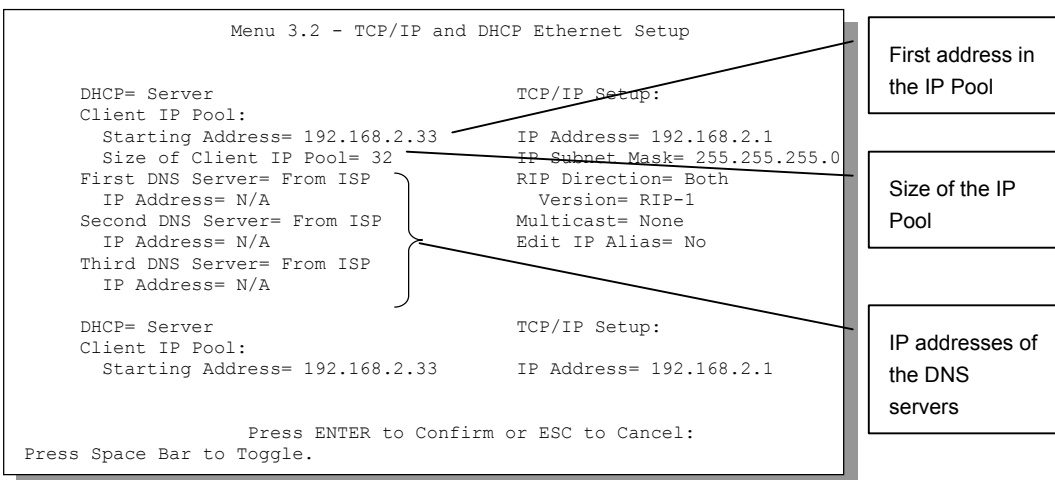

Figure 25-4 Menu 3.2: TCP/IP and DHCP Ethernet Setup

Follow the instructions in the next table on how to configure the DHCP fields.

Table 25-1 DHCP Ethernet Setup Menu Fields

FIELD	DESCRIPTION	EXAMPLE
DHCP	This field enables/disables the DHCP server. If set to Server , your ZyWALL will act as a DHCP server. If set to None , the DHCP server will be disabled. If set to Relay , the ZyWALL acts as a surrogate DHCP server and relays requests and responses between the remote server and the clients. When set to Server , the following items need to be set:	Server
Configuration:		
Client IP Pool Starting Address	This field specifies the first of the contiguous addresses in the IP address pool.	192.168.1.3 3
Size of Client IP Pool	This field specifies the size, or count of the IP address pool.	32

Table 25-1 DHCP Ethernet Setup Menu Fields

FIELD	DESCRIPTION	EXAMPLE
First DNS Server Second DNS Server Third DNS Server	<p>The ZyWALL passes a DNS (Domain Name System) server IP address (in the order you specify here) to the DHCP clients.</p> <p>Select From ISP if your ISP dynamically assigns DNS server information (and the ZyWALL's WAN IP address). The IP Address field below displays the (read-only) DNS server IP address that the ISP assigns.</p> <p>Select User-Defined if you have the IP address of a DNS server. Enter the DNS server's IP address in the IP Address field below. If you chose User-Defined, but leave the IP address set to 0.0.0.0, User-Defined changes to None after you save your changes. If you set a second choice to User-Defined, and enter the same IP address, the second User-Defined changes to None after you save your changes.</p> <p>Select DNS Relay to have the ZyWALL act as a DNS proxy. The ZyWALL's LAN IP address displays in the IP Address field below (read-only). The ZyWALL tells the DHCP clients on the LAN that the ZyWALL itself is the DNS server. When a computer on the LAN sends a DNS query to the ZyWALL, the ZyWALL forwards the query to the ZyWALL's system DNS server (configured in the SYSTEM General screen) and relays the response back to the computer. You can only select DNS Relay for one of the three servers; if you select DNS Relay for a second or third DNS server, that choice changes to None after you save your changes.</p> <p>Select None if you do not want to configure DNS servers. If you do not configure a DNS server, you must know the IP address of a machine in order to access it</p>	
DHCP Server Address	If Relay is selected in the DHCP field above, then type the IP address of the actual, remote DHCP server here.	

Use the instructions in the following table to configure TCP/IP parameters for the LAN port.

LAN and DMZ IP addresses must be on separate subnets.

Table 25-2 LAN TCP/IP Setup Menu Fields

FIELD	DESCRIPTION	EXAMPLE
TCP/IP Setup:		
IP Address	Enter the IP address of your ZyWALL in dotted decimal notation	192.168.1.1 (default)

Table 25-2 LAN TCP/IP Setup Menu Fields

FIELD	DESCRIPTION	EXAMPLE
IP Subnet Mask	Your ZyWALL will automatically calculate the subnet mask based on the IP address that you assign. Unless you are implementing subnetting, use the subnet mask computed by the ZyWALL.	255.255.255.0
RIP Direction	Press [SPACE BAR] and then [ENTER] to select the RIP direction. Options are: Both , In Only , Out Only or None .	Both (default)
Version	Press [SPACE BAR] and then [ENTER] to select the RIP version. Options are: RIP-1 , RIP-2B or RIP-2M .	RIP-1 (default)
Multicast	IGMP (Internet Group Multicast Protocol) is a network-layer protocol used to establish membership in a Multicast group. The ZyWALL supports both IGMP version 1 (IGMP-v1) and version 2 (IGMP-v2). Press [SPACE BAR] and then [ENTER] to enable IP Multicasting or select None (default) to disable it.	None
Edit IP Alias	The ZyWALL supports three logical LAN interfaces via its single physical Ethernet interface with the ZyWALL itself as the gateway for each LAN network. Press [SPACE BAR] to select Yes and then press [ENTER] to display menu 3.2.1	Yes
IP Policies	You can apply up to four IP Policy sets (from twelve) by typing their numbers separated by commas.	2,7,9,11
When you have completed this menu, press [ENTER] at the prompt [Press ENTER to Confirm...] to save your configuration, or press [ESC] at any time to cancel.		

25.4.1 IP Alias Setup

You must use menu 3.2 to configure the first network. Move the cursor to the **Edit IP Alias** field, press [SPACE BAR] to choose **Yes** and press [ENTER] to configure the second and third network.

Press [ENTER] to open **Menu 3.2.1 - IP Alias Setup**, as shown next.

```

Menu 3.2.1 - IP Alias Setup

IP Alias 1= No
IP Address= N/A
IP Subnet Mask= N/A
RIP Direction= N/A
Version= N/A
Incoming protocol filters= N/A
Outgoing protocol filters= N/A
IP Alias 2= No
IP Address= N/A
IP Subnet Mask= N/A
RIP Direction= N/A
Version= N/A
Incoming protocol filters= N/A
Outgoing protocol filters= N/A

Enter here to CONFIRM or ESC to CANCEL:

Press Space Bar to Toggle.
    
```

Figure 25-5 Menu 3.2.1: IP Alias Setup

Use the instructions in the following table to configure IP Alias parameters.

Table 25-3 IP Alias Setup Menu Fields

FIELD	DESCRIPTION	EXAMPLE
IP Alias	Choose Yes to configure the LAN network for the ZyWALL.	Yes
IP Address	Enter the IP address of your ZyWALL in dotted decimal notation.	192.168.2.1
IP Subnet Mask	Your ZyWALL will automatically calculate the subnet mask based on the IP address that you assign. Unless you are implementing subnetting, use the subnet mask computed by the ZyWALL.	255.255.255.0
RIP Direction	Press [SPACE BAR] and then [ENTER] to select the RIP direction. Options are Both, In Only, Out Only or None .	None
Version	Press [SPACE BAR] and then [ENTER] to select the RIP version. Options are RIP-1, RIP-2B or RIP-2M .	RIP-1
Incoming Protocol Filters	Enter the filter set(s) you wish to apply to the incoming traffic between this node and the ZyWALL.	1
Outgoing Protocol Filters	Enter the filter set(s) you wish to apply to the outgoing traffic between this node and the ZyWALL.	2
When you have completed this menu, press [ENTER] at the prompt [Press ENTER to Confirm...] to save your configuration, or press [ESC] at any time to cancel.		

25.5 Wireless LAN Setup

Use menu 3.5 to set up your ZyWALL as the wireless access point.

See the web configurator parts of this *User's Guide* for instructions on WEP and configuring the MAC address filter.

If you are configuring the ZyWALL from a computer connected to the wireless LAN and you change the ZyWALL's ESSID or WEP settings, you will lose your wireless connection when you press [ENTER] to confirm. You must then change the wireless settings of your computer to match the ZyWALL's new settings.

From the main menu, enter 3 to open **Menu 3 – LAN Setup** to configure the Wireless LAN setup. To edit the wireless LAN configuration, enter 5 to open **Menu 3.5 – Wireless LAN Setup** as shown next.

```

Menu 3.5 - Wireless LAN Setup

Enable Wireless LAN= No
ESSID= Wireless
Hide ESSID= No
Channel ID= CH01 2412MHz
RTS Threshold= 2432
Frag. Threshold= 2432
WEP= Disable
  Default Key= N/A
  Key1= N/A
  Key2= N/A
  Key3= N/A
  Key4= N/A
Edit MAC Address Filter= No

Press ENTER to Confirm or ESC to Cancel:

```

Figure 25-6 Menu 3.5 – Wireless LAN Setup

The settings of all client stations on the wireless LAN must match those of the ZyWALL.

Follow the instructions in the next table on how to configure the wireless LAN parameters.

Table 25-4 Wireless LAN Setup Menu Fields

FIELD	DESCRIPTION	EXAMPLE
Enable Wireless LAN	Press [SPACE BAR] to select Yes to turn on the wireless LAN. The wireless LAN is off by default. Configure wireless LAN security features such as Mac filters and 802.1X before you turn on the wireless LAN.	No (default)

Table 25-4 Wireless LAN Setup Menu Fields

FIELD	DESCRIPTION	EXAMPLE
ESSID	(Extended Service Set IDentification) The ESSID identifies the Service Set the station is to connect to. Wireless clients associating to the Access Point must have the same ESSID. Enter a descriptive name (up to 32 characters) for the wireless LAN.	Wireless
Hide ESSID	Press [SPACE BAR] to select Yes to hide the ESSID in the outgoing beacon frame so a station cannot obtain the ESSID through passive scanning.	No (default)
Channel ID	This allows you to set the operating frequency/channel depending on your particular region. Use the [SPACE BAR] to select a channel. CH01 2412 MHz / CH02 2417 MHz ~ CH11 2462 MHz (North America/FCC) CH01 2412 MHz / CH02 2417 MHz ~ CH13 2472 MHz (Europe CE/ ETSI) CH01 2412 MHz / CH02 2417 MHz ~ Ch14 2484 MHz (Japan) CH10 2457 MHz / CH11 2462 MHz (Spain) CH10 2457 MHz / CH11 2462 MHz ~ CH13 2472 MHz (France)	CH01 2412 MHz
RTS Threshold	(Request To Send) The threshold (number of bytes) for enabling RTS/CTS handshake. Data with its frame size larger than this value will perform the RTS/CTS handshake. Setting this attribute to be larger than the maximum MSDU (MAC service data unit) size turns off the RTS/CTS handshake. Setting this attribute to zero turns on the RTS/CTS handshake. Enter a value between 0 and 2432 .	2432 (default)
Frag. Threshold	The threshold (number of bytes) for the fragmentation boundary for directed messages. It is the maximum data fragment size that can be sent. Enter a value between 256 and 2432 .	2432 (default)
WEP	Select Disable to allow wireless stations to communicate with the access points without any data encryption. Select 64-bit WEP or 128-bit WEP to enable data encryption.	Disable
Default Key	Enter the key number (1 to 4) in this field. Only one key can be enabled at any one time. This key must be the same on the ZyWALL and the wireless stations to communicate.	

Table 25-4 Wireless LAN Setup Menu Fields

FIELD	DESCRIPTION	EXAMPLE
Key 1 to Key 4	<p>The WEP keys are used to encrypt data. Both the ZyWALL and the wireless stations must use the same WEP key for data transmission.</p> <p>If you chose 64-bit WEP in the WEP Encryption field, then enter any 5 ASCII characters or 10 hexadecimal characters ("0-9", "A-F").</p> <p>If you chose 128-bit WEP in the WEP Encryption field, then enter 13 ASCII characters or 26 hexadecimal characters ("0-9", "A-F").</p> <hr/> <p style="text-align: center;">Enter "0x" before the key to denote a hexadecimal key. Don't enter "0x" before the key to denote an ASCII key.</p> <hr/>	0x12345abcde
Edit MAC Address Filter	Press [SPACE BAR] to select Yes and then press [ENTER] to display menu 3.5.1	No
<p>When you have completed this menu, press [ENTER] at the prompt "Press ENTER to Confirm..." to save your configuration, or press [ESC] at any time to cancel.</p>		

The ZyWALL LAN Ethernet and wireless ports can transparently communicate with each other (transparent bridge).

25.5.1 MAC Address Filter Setup

Your ZyWALL checks the MAC address of the wireless station device against a list of allowed or denied MAC addresses. However, intruders could fake allowed MAC addresses so MAC-based authentication is less secure than EAP authentication.

Follow the steps below to create the MAC address table on your ZyWALL.

- Step 1.** From the main menu, enter 3 to open **Menu 3 – LAN Setup**.
- Step 2.** Enter 5 to display **Menu 3.5 – Wireless LAN Setup**.
- Step 3.** In the **Edit MAC Address Filter** field, press [SPACE BAR] to select **Yes** and press [ENTER]. **Menu 3.5.1 – WLAN MAC Address Filter** displays as shown next.

```

Menu 3.5.1 - WLAN MAC Address Filter

Active= No
Filter Action= Allowed Association
MAC Address Filter
Address 1= 00:00:00:00:00:00
Address 2= 00:00:00:00:00:00
Address 3= 00:00:00:00:00:00
Address 4= 00:00:00:00:00:00
Address 5= 00:00:00:00:00:00
Address 6= 00:00:00:00:00:00
Address 7= 00:00:00:00:00:00
Address 8= 00:00:00:00:00:00
Address 9= 00:00:00:00:00:00
Address 10= 00:00:00:00:00:00
Address 11= 00:00:00:00:00:00
Address 12= 00:00:00:00:00:00

Enter here to CONFIRM or ESC to CANCEL:

```

Figure 25-7 Menu 3.5.1: WLAN MAC Address Filter

The following table describes the fields in this menu.

Table 25-5 Menu 3.5.1: WLAN MAC Address Filter

FIELD	DESCRIPTION
Active	To enable MAC address filtering, press [SPACE BAR] to select Yes and press [ENTER].
Filter Action	Define the filter action for the list of MAC addresses in the MAC address filter table. To deny access to the ZyWALL, press [SPACE BAR] to select Deny Association and press [ENTER]. MAC addresses not listed will be allowed to access the router. The default action, Allowed Association , permits association with the ZyWALL. MAC addresses not listed will be denied access to the router.
MAC Address Filter	
Address 1..12	Enter the MAC addresses (in XX:XX:XX:XX:XX:XX format) of the client computers that are allowed or denied access to the ZyWALL in these address fields.
When you have completed this menu, press [ENTER] at the prompt [Press ENTER to Confirm...] to save your configuration, or press [ESC] at any time to cancel.	

Chapter 26

DMZ Setup

This chapter describes how to configure the ZyWALL's DMZ using Menu 5: DMZ Setup.

26.1 Configuring DMZ Setup

From the main menu, enter 5 to open **Menu 5 – DMZ Setup**.

```
Menu 5 - DMZ Setup

1. DMZ Port Filter Setup
2. TCP/IP Setup

Enter Menu Selection Number:
```

Figure 26-1 Menu 5: DMZ Setup

26.2 DMZ Port Filter Setup

This menu allows you to specify the filter sets that you wish to apply to your public server(s) traffic. This feature is not available on all models.

```
Menu 5.1 - DMZ Port Filter Setup

Input Filter Sets:
  protocol filters=
  device filters=
Output Filter Sets:
  protocol filters=
  device filters=

Press ENTER to Confirm or ESC to Cancel:
```

Figure 26-2 Menu 5.1: DMZ Port Filter Setup

26.3 TCP/IP Setup

For more detailed information about RIP setup, IP Multicast and IP alias, please refer to the LAN chapter.

26.3.1 IP Address

From the main menu, enter 5 to open **Menu 5 - DMZ Setup** to configure TCP/IP (RFC 1155).

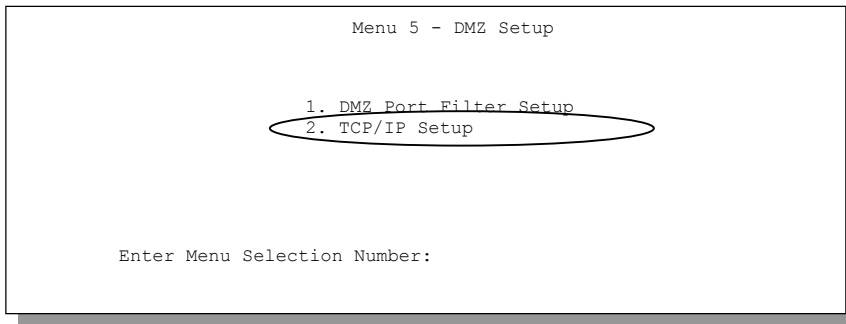

Figure 26-3 Menu 5: TCP/IP Setup

From menu 5, select the submenu option **2. TCP/IP Setup** and press [ENTER]. The screen now displays **Menu 5.2: TCP/IP Setup**, as shown next.

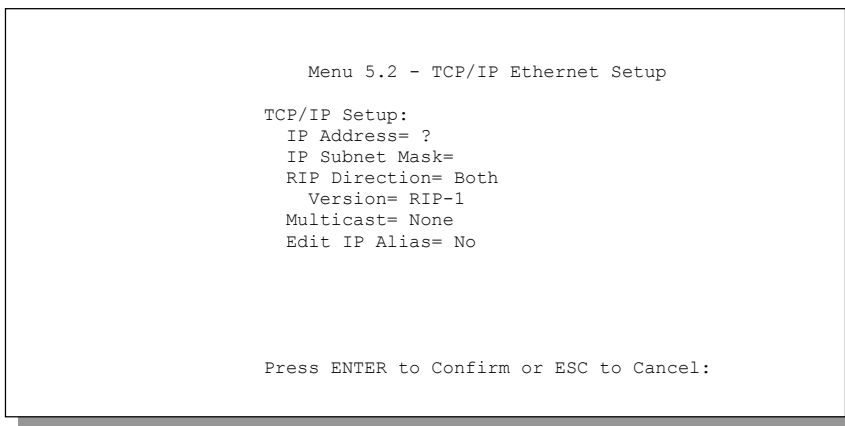

Figure 26-4 Menu 5.2: TCP/IP Setup

The TCP/IP setup fields are the same as the ones in **Menu 3.2 TCP/IP Ethernet Setup**. Each public server will need a unique IP address. Refer to section 25.4 for information on how to configure these fields.

**DMZ and LAN IP addresses must be on separate subnets.
You must also configure NAT for the DMZ port (see the *NAT* chapter) in menus 15.1
and 15.2.**

26.3.2 IP Alias Setup

You must use menu 5.2 to configure the first network. Move the cursor to the **Edit IP Alias** field, press [SPACE BAR] to choose **Yes** and press [ENTER] to configure the second and third network.

Pressing [ENTER] opens **Menu 5.2.1 - IP Alias Setup**, as shown next.

```
Menu 5.2.1 - IP Alias Setup

IP Alias 1= No
IP Address= N/A
IP Subnet Mask= N/A
RIP Direction= N/A
  Version= N/A
Incoming protocol filters= N/A
Outgoing protocol filters= N/A
IP Alias 2= No
IP Address= N/A
IP Subnet Mask= N/A
RIP Direction= N/A
  Version= N/A
Incoming protocol filters= N/A
Outgoing protocol filters= N/A

Enter here to CONFIRM or ESC to CANCEL:

Press Space Bar to Toggle.
```

Figure 26-5 Menu 5.2.1: IP Alias Setup

Refer to *Table 25-3* for instructions on configuring IP Alias parameters.

Chapter 27

Internet Access

This chapter shows you how to configure your ZyWALL for Internet access.

27.1 Introduction to Internet Access Setup

Use information from your ISP along with the instructions in this chapter to set up your ZyWALL to access the Internet. There are three different menu 4 screens depending on whether you chose **Ethernet**, **PPTP** or **PPPoE Encapsulation**. Contact your ISP to determine what encapsulation type you should use.

27.2 Ethernet Encapsulation

If you choose **Ethernet** in menu 4 you will see the next screen.

```

Menu 4 - Internet Access Setup

ISP's Name= ChangeMe
Encapsulation= Ethernet
Service Type= Standard
My Login= N/A
My Password= N/A
Retype to Confirm= N/A
Login Server= N/A
ReLogin Every (min)= N/A
IP Address Assignment= Dynamic
IP Address= N/A
IP Subnet Mask= N/A
Gateway IP Address= N/A
Network Address Translation= SUA Only

Press ENTER to Confirm or ESC to Cancel:
Press ENTER to Confirm or ESC to Cancel:

```

Figure 27-1 Menu 4: Internet Access Setup (Ethernet)

The following table describes the fields in this screen.

Table 27-1 Menu 4: Internet Access Setup Menu Fields

FIELD	DESCRIPTION
ISP's Name	Enter the name of your Internet Service Provider, e.g., myISP. This information is for identification purposes only.

Table 27-1 Menu 4: Internet Access Setup Menu Fields

FIELD	DESCRIPTION
Encapsulation	Press [SPACE BAR] and then press [ENTER] to choose Ethernet . The encapsulation method influences your choices for the IP Address field.
Service Type	Press [SPACE BAR] and then [ENTER] to select Standard , RR-Toshiba (RoadRunner Toshiba authentication method), RR-Manager (RoadRunner Manager authentication method) or RR-Telstra . Choose a RoadRunner flavor if your ISP is Time Warner's RoadRunner; otherwise choose Standard .
Note: DSL users must choose the Standard option only. The My Login , My Password and Login Server fields are not applicable in this case.	
My Login	Enter the login name given to you by your ISP.
My Password	Enter the password associated with the login name above.
Retype to Confirm	Enter your password again to make sure that you have entered is correctly.
Login Server	The ZyWALL will find the RoadRunner Server IP if this field is left blank. If it does not, then you must enter the authentication server IP address.
Relogin Every (min)	This field is available when you select Telia Login in the Service Type field. The Telia server logs the ZyWALL out if the ZyWALL does not log in periodically. Type the number of minutes from 1 to 59 (30 recommended) for the ZyWALL to wait between logins.
IP Address Assignment	If your ISP did not assign you a fixed IP address, press [SPACE BAR] and then [ENTER] to select Dynamic , otherwise select Static and enter the IP address and subnet mask in the following fields.
IP Address	Enter the (fixed) IP address assigned to you by your ISP (static IP address Assignment is selected in the previous field).
IP Subnet Mask	Enter the subnet mask associated with your static IP.
Gateway IP Address	Enter the gateway IP address associated with your static IP.

Table 27-1 Menu 4: Internet Access Setup Menu Fields

FIELD	DESCRIPTION
Network Address Translation	<p>Network Address Translation (NAT) allows the translation of an Internet protocol address used within one network (for example a private IP address used in a local network) to a different IP address known within another network (for example a public IP address used on the Internet).</p> <p>Choose None to disable NAT.</p> <p>Choose SUA Only if you have a single public IP address. SUA (Single User Account) is a subset of NAT that supports two types of mapping: Many-to-One and Server.</p> <p>Choose Full Feature if you have multiple public IP addresses. Full Feature mapping types include: One-to-One, Many-to-One (SUA/PAT), Many-to-Many Overload, Many- One-to-One and Server. When you select Full Feature you must configure at least one address mapping set!</p> <p>Please see the NAT chapter for a more detailed discussion on the Network Address Translation feature.</p>
<p>When you have completed this menu, press [ENTER] at the prompt "Press ENTER to Confirm..." to save your configuration, or press [ESC] at any time to cancel.</p>	

27.3 Configuring the PPTP Client

The ZyWALL supports only one PPTP server connection at any given time.

To configure a PPTP client, you must configure the **My Login** and **Password** fields for a PPP connection and the PPTP parameters for a PPTP connection.

After configuring **My Login** and **Password** for PPP connection, press [SPACE BAR] and then [ENTER] in the **Encapsulation** field in **Menu 4 -Internet Access Setup** to choose **PPTP** as your encapsulation option.

This brings up the following screen.

```

Menu 4 - Internet Access Setup

ISP's Name= ChangeMe
Encapsulation= PPTP
Service Type= N/A
My Login=
My Password= *****
Retype to Confirm= *****
Idle Timeout= 100

IP Address Assignment= Dynamic
IP Address= N/A
IP Subnet Mask= N/A
Gateway IP Address= N/A
Network Address Translation= SUA Only

Press ENTER to Confirm or ESC to Cancel:
Press Space Bar to Toggle.

```

Figure 27-2 Internet Access Setup (PPTP)

The following table contains instructions about the new fields when you choose **PPTP** in the **Encapsulation** field in menu 4.

Table 27-2 New Fields in Menu 4 (PPTP) Screen

FIELD	DESCRIPTION	EXAMPLE
Encapsulation	Press [SPACE BAR] and then press [ENTER] to choose PPTP . The encapsulation method influences your choices for the IP Address field.	PPTP
Idle Timeout	This value specifies the time, in seconds, that elapses before the ZyWALL automatically disconnects from the PPTP server.	100 (default)

27.4 Configuring the PPPoE Client

If you enable PPPoE in menu 4, you will see the next screen. For more information on PPPoE, please see the *Appendices*.

```

Menu 4 - Internet Access Setup

ISP's Name= ChangeMe
Encapsulation= PPPoE
Service Type= N/A
My Login=
My Password= *****
Retype to Confirm= *****
Idle Timeout= 100

IP Address Assignment= Dynamic
IP Address= N/A
IP Subnet Mask= N/A
Gateway IP Address= N/A
Network Address Translation= SUA Only

Press ENTER to Confirm or ESC to Cancel:
Press Space Bar to Toggle.

```

Figure 27-3 Internet Access Setup (PPPoE)

The following table describes the fields in this screen.

Table 27-3 New Fields in Menu 4 (PPPoE) screen

FIELD	DESCRIPTION	EXAMPLE
Encapsulation	Press [SPACE BAR] and then press [ENTER] to choose PPPoE . The encapsulation method influences your choices in the IP Address field.	PPPoE
Idle Timeout	This value specifies the time in seconds that elapses before the ZyWALL automatically disconnects from the PPPoE server.	100 (default)

If you need a PPPoE service name to identify and reach the PPPoE server, please go to menu 11 and enter the PPPoE service name provided to you in the **Service Name** field.

27.5 Basic Setup Complete

Well done! You have successfully connected, installed and set up your ZyWALL to operate on your network as well as access the Internet.

When the firewall is activated, the default policy allows all communications to the Internet that originate from the LAN, and blocks all traffic to the LAN that originates from the Internet.

You may deactivate the firewall in menu 21.2 or via the ZyWALL embedded web configurator. You may also define additional firewall rules or modify existing ones but please exercise extreme caution in doing so. See the *firewall chapters* for more information on the firewall.

Part XII:

SMT Advanced Applications

This part covers setting up remote nodes, IP static routes and Network Address Translation. It also covers the SMT firewall menu, filters and SNMP.

See the web configurator parts of this guide for background information on features configurable by web configurator and SMT.

Chapter 28

Remote Node Setup

This chapter shows you how to configure a remote node.

28.1 Introduction to Remote Node Setup

A remote node is required for placing calls to a remote gateway. A remote node represents both the remote gateway and the network behind it across a WAN connection. Note that when you use menu 4 to set up Internet access, you are actually configuring a remote node. The following describes how to configure **Menu 11.1 Remote Node Profile**, **Menu 11.3 - Remote Node Network Layer Options** and **Menu 11.5 - Remote Node Filter**.

28.2 Remote Node Setup

From the main menu, select menu option 11 to open **Menu 11 Remote Node Setup** (shown below).

Then enter **1** to open **Menu 11.1 Remote Node Profile** and configure the setup for your regular ISP. Enter **2** to open **Menu 11.1 Remote Node Profile (Backup ISP)** and configure the setup for your Dial Backup port connection (see the *WAN and Dial Backup Setup* chapter).

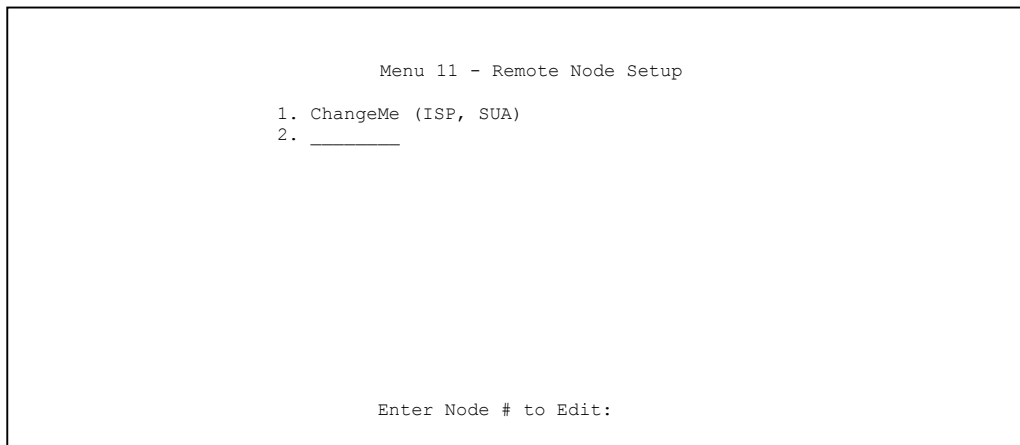

Figure 28-1 Menu 11 Remote Node Setup

28.3 Remote Node Profile Setup

The following explains how to configure the remote node profile menu.

28.3.1 Ethernet Encapsulation

There are two variations of menu 11.1 depending on whether you choose **Ethernet Encapsulation** or **PPPoE Encapsulation**. You must choose the **Ethernet** option when the WAN port is used as a regular Ethernet. The first menu 11.1 screen you see is for Ethernet encapsulation shown next.

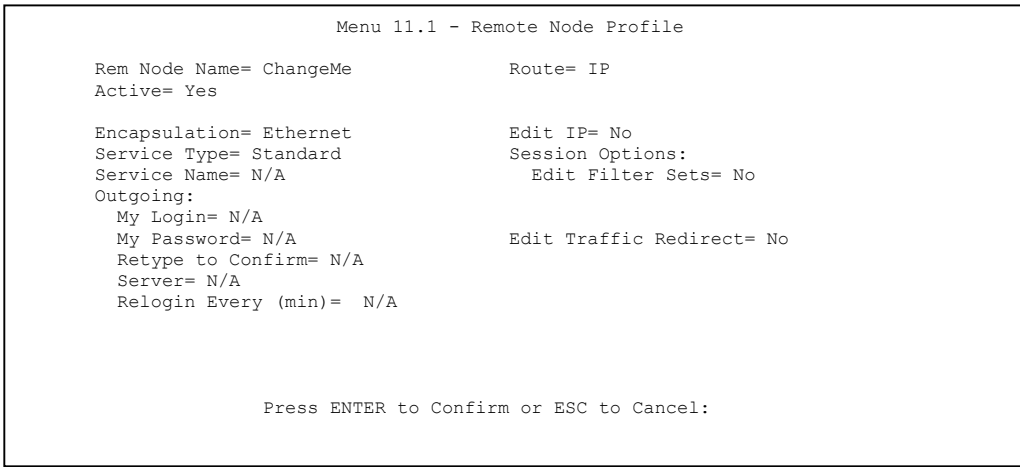

Figure 28-2 Menu 11.1: Remote Node Profile for Ethernet Encapsulation

The following table describes the fields in this screen.

Table 28-1 Fields in Menu 11.1

FIELD	DESCRIPTION	EXAMPLE
Rem Node Name	Enter a descriptive name for the remote node. This field can be up to eight characters.	LAoffice
Active	Press [SPACE BAR] and then [ENTER] to select Yes (activate remote node) or No (deactivate remote node).	Yes
Encapsulation	Ethernet is the default encapsulation. Press [SPACE BAR] and then [ENTER] to change to PPPoE or PPTP encapsulation.	Ethernet
Service Type	Press [SPACE BAR] and then [ENTER] to select from Standard , RR-Toshiba (RoadRunner Toshiba authentication method) or RR-Manager (RoadRunner Manager authentication method). Choose one of the RoadRunner methods if your ISP is Time Warner's RoadRunner; otherwise choose Standard .	Standard
Outgoing My Login	This field is applicable for PPPoE encapsulation only. Enter the login name assigned by your ISP when the ZyWALL calls this remote node. Some ISPs append this field to the Service Name field above (e.g., jim@poellc) to access the PPPoE server.	jim
My Password	Enter the password assigned by your ISP when the ZyWALL calls this remote node. Valid for PPPoE encapsulation only.	*****

Table 28-1 Fields in Menu 11.1

FIELD	DESCRIPTION	EXAMPLE
Retype to Confirm	Type your password again to make sure that you have entered it correctly.	*****
Server	This field is valid only when RoadRunner is selected in the Service Type field. The ZyWALL will find the RoadRunner Server IP automatically if this field is left blank. If it does not, then you must enter the authentication server IP address here.	
Relogin Every (min)	This field is available when you select Telia Login in the Service Type field. The Telia server logs the ZyWALL out if the ZyWALL does not log in periodically. Type the number of minutes from 1 to 59 (30 recommended) for the ZyWALL to wait between logins.	
Route	This field refers to the protocol that will be routed by your ZyWALL – IP is the only option for the ZyWALL.	IP
Edit IP	This field leads to a “hidden” menu. Press [SPACE BAR] to select Yes and press [ENTER] to go to Menu 11.3 - Remote Node Network Layer Options .	No (default)
Session Options Edit Filter sets	This field leads to another “hidden” menu. Use [SPACE BAR] to select Yes and press [ENTER] to open menu 11.5 to edit the filter sets. See the <i>Remote Node Filter</i> section for more details.	No (default)
Once you have configured this menu, press [ENTER] at the message “Press ENTER to Confirm...” to save your configuration, or press [ESC] at any time to cancel.		

28.3.2 PPPoE Encapsulation

The ZyWALL supports PPPoE (Point-to-Point Protocol over Ethernet). You can only use PPPoE encapsulation when you’re using the ZyWALL with a DSL modem as the WAN device. If you change the Encapsulation to **PPPoE**, then you will see the next screen. Please see the *Appendices* for more information on PPPoE.

```

Menu 11.1 - Remote Node Profile

Rem Node Name= ChangeMe           Route= IP
Active= Yes

Encapsulation= PPPoE              Edit IP= No
Service Type= Standard            Telco Option:
Service Name=                      Allocated Budget(min)= 0
Outgoing:                          Period(hr)= 0
  My Login=                        Schedules=
  My Password= *****            Nailed-Up Connection= No
  Retype to Confirm= *****
  Authen= CHAP/PAP

Session Options:
  Edit Filter Sets= No
  Idle Timeout(sec)= 100

Edit Traffic Redirect= No

Press ENTER to Confirm or ESC to Cancel:

Press Space Bar to Toggle.

```

Figure 28-3 Menu 11.1: Remote Node Profile for PPPoE Encapsulation

Outgoing Authentication Protocol

Generally speaking, you should employ the strongest authentication protocol possible, for obvious reasons. However, some vendor's implementation includes a specific authentication protocol in the user profile. It will disconnect if the negotiated protocol is different from that in the user profile, even when the negotiated protocol is stronger than specified. If you encounter a case where the peer disconnects right after a successful authentication, please make sure that you specify the correct authentication protocol when connecting to such an implementation.

Nailed-Up Connection

A nailed-up connection is a dial-up line where the connection is always up regardless of traffic demand. The ZyWALL does two things when you specify a nailed-up connection. The first is that idle timeout is disabled. The second is that the ZyWALL will try to bring up the connection when turned on and whenever the connection is down. A nailed-up connection can be very expensive for obvious reasons.

Do not specify a nailed-up connection unless your telephone company offers flat-rate service or you need a constant connection and the cost is of no concern.

The following table describes the fields not already described in *Table 28-1*.

Metric

See the *Metric* section in the *WAN and Dial Backup Setup* chapter for details on the **Metric** field.

Table 28-2 Fields in Menu 11.1 (PPPoE Encapsulation Specific)

FIELD	DESCRIPTION	EXAMPLE
Service Name	If you are using PPPoE encapsulation, then type the name of your PPPoE service here. Only valid with PPPoE encapsulation.	poelc
Authen	This field sets the authentication protocol used for outgoing calls. Options for this field are: CHAP/PAP - Your ZyWALL will accept either CHAP or PAP when requested by this remote node. CHAP - accept CHAP only. PAP - accept PAP only.	CHAP/PAP
Telco Option		
Allocated Budget	The field sets a ceiling for outgoing call time for this remote node. The default for this field is 0 meaning no budget control.	0 (default)
Period(hr)	This field is the time period that the budget should be reset. For example, if we are allowed to call this remote node for a maximum of 10 minutes every hour, then the Allocated Budget is (10 minutes) and the Period(hr) is 1 (hour).	0 (default)
Schedules	You can apply up to four schedule sets here. For more details please refer to the <i>Call Schedule Setup</i> chapter.	
Nailed-Up Connection	This field specifies if you want to make the connection to this remote node a nailed-up connection. More details are given earlier in this section.	No (default)
Session Options	Type the length of idle time (when there is no traffic from the ZyWALL to the remote node) in seconds that can elapse before the ZyWALL automatically disconnects the PPPoE connection. This option only applies when the ZyWALL initiates the call.	100 seconds (default)
Idle Timeout		

28.3.3 PPTP Encapsulation

If you change the Encapsulation to **PPTP** in menu 11.1, then you will see the next screen. Please see the *Appendices* for information on PPTP.

```

Menu 11.1 - Remote Node Profile

Rem Node Name= ChangeMe           Route= IP
Active= Yes

Encapsulation= PPTP               Edit IP= No
Service Type= Standard           Telco Option:
Service Name=N/A                 Allocated Budget(min)= 0
Outgoing=                         Period(hr)= 0
  My Login=                       Schedules=
  My Password= *****           Nailed-up Connections=
  Retype to Confirm= *****
Authen= CHAP/PAP

PPTP :
  My IP Addr=                     Session Options:
  My IP Mask=                     Edit Filter Sets= No
  Server IP Addr=                 Idle Timeout(sec)= 100
  Connection ID/Name=            Edit Traffic Redirect= No

Press ENTER to Confirm or ESC to Cancel:

Press Space Bar to Toggle.

```

Figure 28-4 Menu 11.1: Remote Node Profile for PPTP Encapsulation

The next table shows how to configure fields in menu 11.1 not previously discussed.

Table 28-3 Fields in Menu 11.1 (PPTP Encapsulation)

FIELD	DESCRIPTION	EXAMPLE
Encapsulation	Press [SPACE BAR] and then [ENTER] to select PPTP . You must also go to menu 11.3 to check the IP Address setting once you have selected the encapsulation method.	PPTP
My IP Addr	Enter the IP address of the WAN Ethernet port.	10.0.0.140
My IP Mask	Enter the subnet mask of the WAN Ethernet port.	255.255.255.0
My Server IP Addr	Enter the IP address of the ANT modem.	10.0.0.138
Connection ID/Name	Enter the connection ID or connection name in the ANT. It must follow the "c:id" and "n:name" format. This field is optional and depends on the requirements of your DSL modem.	N:My ISP
Schedules	You can apply up to four schedule sets here. For more details refer to the <i>Call Schedule Setup</i> chapter.	

Table 28-3 Fields in Menu 11.1 (PPTP Encapsulation)

FIELD	DESCRIPTION	EXAMPLE
Nailed-Up Connections	Press [SPACE BAR] and then [ENTER] to select Yes if you want to make the connection to this remote node a nailed-up connection.	No

28.4 Edit IP

Move the cursor to the **Edit IP** field in menu 11.1, then press [SPACE BAR] to select **Yes**. Press [ENTER] to open **Menu 11.3 - Network Layer Options**.

```

Menu 11.3 - Remote Node Network Layer Options

IP Address Assignment= Dynamic
IP Address= N/A
IP Subnet Mask= N/A
Gateway IP Addr= N/A

Network Address Translation= SUA Only
Metric= N/A
Private= N/A
RIP Direction= None
    Version= N/A
Multicast= None

Enter here to CONFIRM or ESC to CANCEL:
    
```

Figure 28-5 Menu 11.3: Remote Node Network Layer Options for Ethernet Encapsulation

This menu displays the **My WAN Addr** field for **PPPoE** and **PPTP** encapsulations and **Gateway IP Addr** field for **Ethernet** encapsulation. The following table describes the fields in this screen.

Table 28-4 Remote Node Network Layer Options Menu Fields

FIELD	DESCRIPTION	EXAMPLE
IP Address Assignment	If your ISP did not assign you an explicit IP address, press [SPACE BAR] and then [ENTER] to select Dynamic ; otherwise select Static and enter the IP address & subnet mask in the following fields.	Dynamic (default)
(Rem) IP Address	If you have a Static IP Assignment, enter the IP address assigned to you by your ISP.	

Table 28-4 Remote Node Network Layer Options Menu Fields

FIELD	DESCRIPTION	EXAMPLE
(Rem) IP Subnet Mask	If you have a static IP Assignment, enter the subnet mask assigned to you.	
Gateway IP Addr	This field is applicable to Ethernet encapsulation only. Enter the gateway IP address assigned to you if you are using a static IP address.	
My WAN Addr	<p>This field is applicable to PPPoE and PPTP encapsulations only. Some implementations, especially the UNIX derivatives, require the WAN link to have a separate IP network number from the LAN and each end must have a unique address within the WAN network number. If this is the case, enter the IP address assigned to the WAN port of your ZyWALL.</p> <p>Note that this is the address assigned to your local ZyWALL, not the remote router.</p>	
Network Address Translation	<p>Network Address Translation (NAT) allows the translation of an Internet protocol address used within one network (for example a private IP address used in a local network) to a different IP address known within another network (for example a public IP address used on the Internet).</p> <p>Choose None to disable NAT.</p> <p>Choose SUA Only if you have a single public IP address. SUA (Single User Account) is a subset of NAT that supports two types of mapping: Many-to-One and Server.</p> <p>Choose Full Feature if you have multiple public IP addresses. Full Feature mapping types include: One-to-One, Many-to-One (SUA/PAT), Many-to-Many Overload, Many- One-to-One and Server. When you select Full Feature you must configure at least one address mapping set!</p> <p>See the <i>NAT chapter</i> for a full discussion on this feature.</p>	SUA Only (default)
Metric	Enter a number from 1 to 15 to set this route's priority among the ZyWALL's routes (see the <i>Metric</i> section in the <i>WAN and Dial Backup Setup</i> chapter) The smaller the number, the higher priority the route has.	1
Private	This field is valid only for PPTP/PPPoE encapsulation. This parameter determines if the ZyWALL will include the route to this remote node in its RIP broadcasts. If set to Yes , this route is kept private and not included in RIP broadcast. If No , the route to this remote node will be propagated to other hosts through RIP broadcasts.	No

Table 28-4 Remote Node Network Layer Options Menu Fields

FIELD	DESCRIPTION	EXAMPLE
RIP Direction	Press [SPACE BAR] and then [ENTER] to select the RIP direction from Both/ None/In Only/Out Only . See the <i>LAN Setup</i> chapter for more information on RIP. The default for RIP on the WAN side is None . It is recommended that you do not change this setting.	None (default)
Version	Press [SPACE BAR] and then [ENTER] to select the RIP version from RIP-1/RIP-2B/RIP-2M or None .	N/A
Multicast	IGMP (Internet Group Multicast Protocol) is a network-layer protocol used to establish membership in a Multicast group. The ZyWALL supports both IGMP version 1 (IGMP-v1) and version 2 (IGMP-v2). Press [SPACE BAR] to enable IP Multicasting or select None to disable it. See the <i>LAN Setup</i> chapter for more information on this feature.	None (default)
Once you have completed filling in Menu 11.3 Remote Node Network Layer Options , press [ENTER] at the message "Press ENTER to Confirm..." to save your configuration and return to menu 11, or press [ESC] at any time to cancel.		

28.5 Remote Node Filter

Move the cursor to the field **Edit Filter Sets** in menu 11.1, and then press [SPACE BAR] to set the value to **Yes**. Press [ENTER] to open **Menu 11.5 - Remote Node Filter**.

Use menu 11.5 to specify the filter set(s) to apply to the incoming and outgoing traffic between this remote node and the ZyWALL to prevent certain packets from triggering calls. You can specify up to 4 filter sets separated by commas, for example, 1, 5, 9, 12, in each filter field. Note that spaces are accepted in this field. For more information on defining the filters, please refer to the Filters chapter. For PPPoE or PPTP encapsulation, you have the additional option of specifying remote node call filter sets.

```
Menu 11.5 - Remote Node Filter

Input Filter Sets:
  protocol filters=
  device filters=
Output Filter Sets:
  protocol filters=
  device filters=

Enter here to CONFIRM or ESC to CANCEL:
```

Figure 28-6 Menu 11.5: Remote Node Filter (Ethernet Encapsulation)

```
Menu 11.5 - Remote Node Filter

Input Filter Sets:
  protocol filters=
  Device filters=
Output Filter Sets:
  protocol filters=
  device filters=
Call Filter Sets:
  protocol filters=
  Device filters=

Enter here to CONFIRM or ESC to CANCEL:
```

Figure 28-7 Menu 11.5: Remote Node Filter (PPPoE or PPTP Encapsulation)

To configure the parameters for traffic redirect, enter 11 from the main menu to display **Menu 11.1—Remote Node Profile** as shown next.

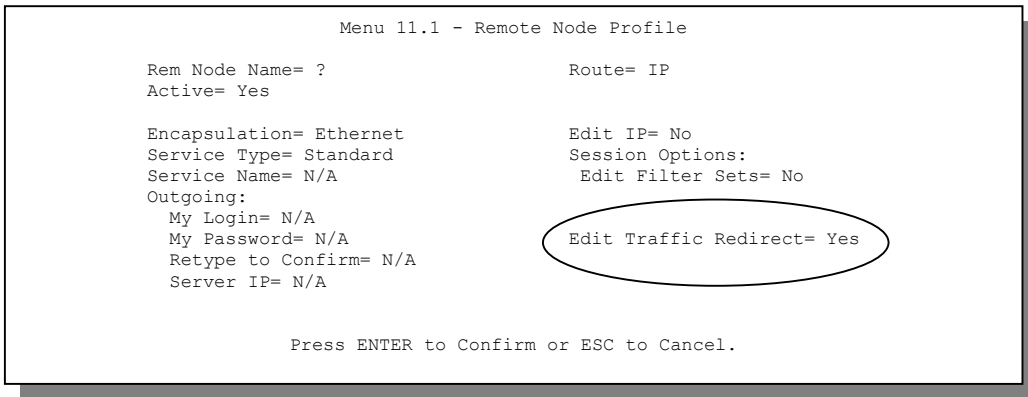

Figure 28-8 Menu 11.1: Remote Node Profile

To configure traffic redirect properties, press [SPACE BAR] to select **Yes** in the **Edit Traffic Redirect** field and then press [ENTER].

Table 28-5 Menu 11.1: Remote Node Profile (Traffic Redirect Field)

FIELD	DESCRIPTION	EXAMPLE
Edit Traffic Redirect	Press [SPACE BAR] to select Yes or No . Select No (default) if you do not want to configure this feature. Select Yes and press [ENTER] to configure Menu 11.6 — Traffic Redirect Setup .	Yes
Press [ENTER] at the message “Press ENTER to Confirm...” to save your configuration, or press [ESC] at any time to cancel.		

28.5.1 Traffic Redirect Setup

Configure parameters that determine when the ZyWALL will forward WAN traffic to the backup gateway using **Menu 11.6 — Traffic Redirect Setup**.

```

Menu 11.6 - Traffic Redirect Setup

Active= Yes
Configuration:
  Backup Gateway IP Address= 0.0.0.0
  Metric= 15
  Check WAN IP Address= 0.0.0.0
  Fail Tolerance= 2
  Period (sec)= 5
  Timeout (sec)= 3

Press ENTER to Confirm or ESC to Cancel:

Press Space Bar to Toggle.

```

Figure 28-9 Menu 11.6: Traffic Redirect Setup

The following table describes the fields in this screen.

Table 28-6 Menu 11.6: Traffic Redirect Setup

FIELD	DESCRIPTION	EXAMPLE
Active	Press [SPACE BAR] and select Yes (to enable) or No (to disable) traffic redirect setup. The default is No .	Yes
Configuration: Backup Gateway IP Address	Enter the IP address of your backup gateway in dotted decimal notation. The ZyWALL automatically forwards traffic to this IP address if the ZyWALL's Internet connection terminates.	0.0.0.0
Metric	Enter a number from 1 to 15 to set this route's priority among the ZyWALL's routes (see the <i>Metric</i> section in the <i>WAN and Dial Backup Setup</i> chapter) The smaller the number, the higher priority the route has.	15 (default)
Check WAN IP Address	Enter the IP address of a reliable nearby computer (for example, your ISP's DNS server address) to test your ZyWALL's WAN accessibility. The ZyWALL uses the default gateway IP address if you do not enter an IP address here. If you are using PPTP or PPPoE Encapsulation, enter "0.0.0.0" to configure the ZyWALL to check the PVC (Permanent Virtual Circuit) or PPTP tunnel.	0.0.0.0

Table 28-6 Menu 11.6: Traffic Redirect Setup

FIELD	DESCRIPTION	EXAMPLE
Fail Tolerance	Enter the number of times your ZyWALL may attempt and fail to connect to the Internet before traffic is forwarded to the backup gateway. Two to five is usually a good number.	2
Period (sec)	Enter the time interval (in seconds) between WAN connection checks. Five to 60 is usually a good number.	5
Timeout (sec)	Enter the number of seconds the ZyWALL waits for a ping response from the IP Address in the Check WAN IP Address field before it times out. The number in this field should be less than the number in the Period field. Three to 50 is usually a good number. The WAN connection is considered “down” after the ZyWALL times out the number of times specified in the Fail Tolerance field.	3
When you have completed this menu, press [ENTER] at the prompt “Press [ENTER] to confirm or [ESC] to cancel” to save your configuration or press [ESC] to cancel and go back to the previous screen.		

Chapter 29

IP Static Route Setup

This chapter shows you how to configure static routes with your ZyWALL.

29.1 IP Static Route Setup

Enter 12 from the main menu. Select one of the IP static routes as shown next to configure IP static routes in menu 12. 1.

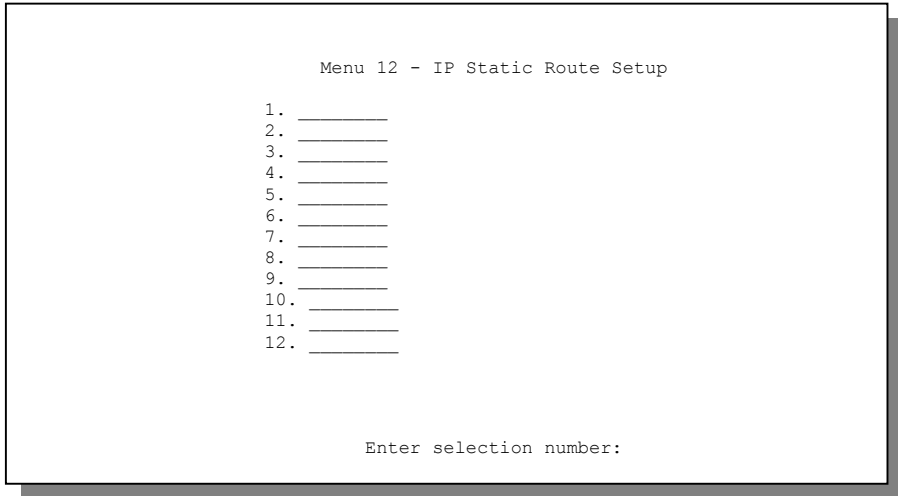

```
Menu 12 - IP Static Route Setup

1. _____
2. _____
3. _____
4. _____
5. _____
6. _____
7. _____
8. _____
9. _____
10. _____
11. _____
12. _____

Enter selection number:
```

Figure 29-1 Menu 12: IP Static Route Setup

Now, enter the index number of the static route that you want to configure.

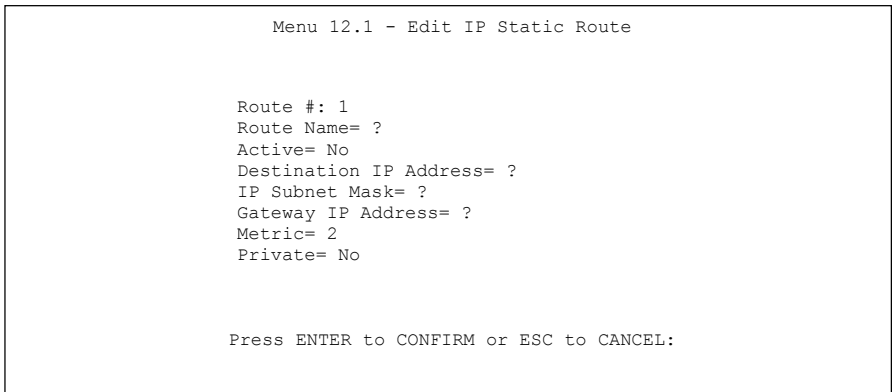

Figure 29-2 Menu 12. 1: Edit IP Static Route

The following table describes the IP Static Route Menu fields.

Table 29-1 IP Static Route Menu Fields

FIELD	DESCRIPTION
Route #	This is the index number of the static route that you chose in menu 12.
Route Name	Enter a descriptive name for this route. This is for identification purposes only.
Active	This field allows you to activate/deactivate this static route.
Destination IP Address	This parameter specifies the IP network address of the final destination. Routing is always based on network number. If you need to specify a route to a single host, use a subnet mask of 255.255.255.255 in the subnet mask field to force the network number to be identical to the host ID.
IP Subnet Mask	Enter the IP subnet mask for this destination.
Gateway IP Address	Enter the IP address of the gateway. The gateway is an immediate neighbor of your ZyWALL that will forward the packet to the destination. On the LAN, the gateway must be a router on the same segment as your ZyWALL; over the WAN, the gateway must be the IP address of one of the remote nodes.
Metric	Enter a number from 1 to 15 to set this route's priority among the ZyWALL's routes (see the <i>Metric</i> section in the <i>WAN and Dial Backup Setup</i> chapter). The smaller the number, the higher priority the route has.

Table 29-1 IP Static Route Menu Fields

FIELD	DESCRIPTION
Private	This parameter determines if the ZyWALL will include the route to this remote node in its RIP broadcasts. If set to Yes , this route is kept private and not included in RIP broadcast. If No , the route to this remote node will be propagated to other hosts through RIP broadcasts.
Once you have completed filling in this menu, press [ENTER] at the message "Press ENTER to Confirm..." to save your configuration, or press [ESC] to cancel.	

Chapter 30

Network Address Translation (NAT)

This chapter discusses how to configure NAT on the ZyWALL.

30.1 Using NAT

You must create a firewall rule in addition to setting up SUA/NAT, to allow traffic from the WAN to be forwarded through the ZyWALL.

30.1.1 SUA (Single User Account) Versus NAT

SUA (Single User Account) is a ZyNOS implementation of a subset of NAT that supports two types of mapping, **Many-to-One** and **Server**. See *section 30.2.1* for a detailed description of the NAT set for SUA. The ZyWALL also supports **Full Feature** NAT to map multiple global IP addresses to multiple private LAN IP addresses of clients or servers using mapping types as outlined in the web configurator parts of this *User's Guide*.

-
- 1. Choose SUA Only if you have just one public WAN IP address for your ZyWALL.**
 - 2. Choose Full Feature if you have multiple public WAN IP addresses for your ZyWALL.**
-

30.1.2 Applying NAT

You apply NAT via menus 4 or 11.3 as displayed next. The next figure shows you how to apply NAT for Internet access in menu 4. Enter 4 from the main menu to go to **Menu 4 - Internet Access Setup**

```
Menu 4 - Internet Access Setup

ISP's Name= ChangeMe
Encapsulation= Ethernet
Service Type= Standard
My Login= N/A
My Password= N/A
Retype to Confirm= N/A
Login Server= N/A
Relogin Every (min)= N/A
IP Address Assignment= Dynamic
IP Address= N/A
IP Subnet Mask= N/A
Gateway IP Address= N/A
Network Address Translation= SUA Only

Press ENTER to Confirm or ESC to Cancel:
Press ENTER to Confirm or ESC to Cancel:
```

Figure 30-1 Menu 4: Applying NAT for Internet Access

The following figure shows how you apply NAT to the remote node in menu 11.1.

- Step 1.** Enter 11 from the main menu.
- Step 2.** Move the cursor to the **Edit IP** field, press [SPACE BAR] to select **Yes** and then press [ENTER] to bring up **Menu 11.3 - Remote Node Network Layer Options**.

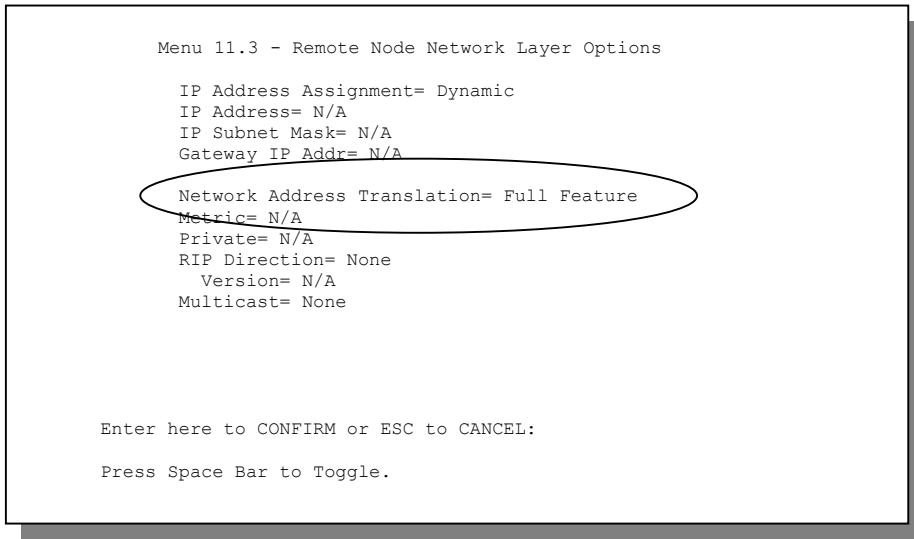

Figure 30-2 Menu 11.3: Applying NAT to the Remote Node

The following table describes the fields in this screen.

Table 30-1 Applying NAT in Menus 4 & 11.3

FIELD	DESCRIPTION	OPTIONS
Network Address Translation	<p>When you select this option the SMT will use Address Mapping Set 1 (menu 15.1 - see <i>section 30.2.1</i> for further discussion). You can configure any of the mapping types described in the web configurator parts of this <i>User's Guide</i>. Choose Full Feature if you have multiple public WAN IP addresses for your ZyWALL.</p> <p>When you select Full Feature you must configure at least one address mapping set!</p>	Full Feature
	NAT is disabled when you select this option.	None
	<p>When you select this option the SMT will use Address Mapping Set 255 (menu 15.1 - see <i>section 30.2.1</i>). Choose SUA Only if you have just one public WAN IP address for your ZyWALL.</p>	SUA Only

30.2 NAT Setup

Use the address mapping sets menus and submenus to create the mapping table used to assign global addresses to computers on the LAN and the DMZ. You can see two NAT address mapping sets in menu 15.1. You can only configure **Set 1**. **Set 255** is used for SUA. When you select **Full Feature** in menu 4 or 11.3, the SMT will use **Set 1**. When you select **SUA Only**, the SMT will use the pre-configured **Set 255** (read only).

The server set is a list of LAN and DMZ servers mapped to external ports. To use this set, a server rule must be set up inside the NAT address mapping set. Please see the section on port forwarding in the chapter on NAT web configurator screens for further information on these menus. To configure NAT, enter 15 from the main menu to bring up the following screen.

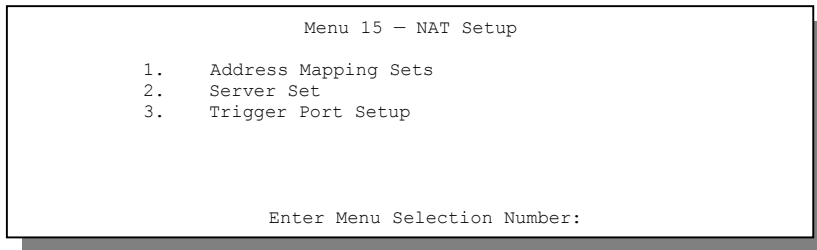

Figure 30-3 Menu 15: NAT Setup

Configure DMZ and LAN IP addresses in NAT menus 15.1 and 15.2. DMZ IP addresses must be on subnets separate from LAN IP addresses.

30.2.1 Address Mapping Sets

Enter 1 to bring up **Menu 15.1 — Address Mapping Sets**.

```

Menu 15.1 - Address Mapping Sets

1.
255. SUA (read only)

Enter Menu Selection Number:

```

Figure 30-4 Menu 15.1: Address Mapping Sets

SUA Address Mapping Set

Enter 255 to display the next screen (see also *section 30.1.1*). The fields in this menu cannot be changed.

```

Menu 15.1.255 - Address Mapping Rules

Set Name= SUA

Idx  Local Start IP  Local End IP  Global Start IP  Global End IP  Type
----  -
1.   0.0.0.0          255.255.255.255  0.0.0.0          -----
2.                                     0.0.0.0          Server
3.
4.
5.
6.
7.
8.
9.
10.

Press ENTER to Confirm or ESC to Cancel:

```

Figure 30-5 Menu 15.1.255: SUA Address Mapping Rules

The following table explains the fields in this screen.

Menu 15.1.255 is read-only.

Table 30-2 SUA Address Mapping Rules

FIELD	DESCRIPTION	EXAMPLE
Set Name	This is the name of the set you selected in menu 15.1 or enter the name of a new set you want to create.	SUA
Idx	This is the index or rule number.	1
Local Start IP	Local Start IP is the starting local IP address (ILA).	0.0.0.0
Local End IP	Local End IP is the ending local IP address (ILA). If the rule is for all local IPs, then the start IP is 0.0.0.0 and the end IP is 255.255.255.255.	255.255.255.255
Global Start IP	This is the starting global IP address (IGA). If you have a dynamic IP, enter 0.0.0.0 as the Global Start IP .	0.0.0.0
Global End IP	This is the ending global IP address (IGA).	
Type	These are the mapping types discussed above. Server allows us to specify multiple servers of different types behind NAT to this machine. See later for some examples.	Server
<p>Once you have finished configuring a rule in this menu, press [ENTER] at the message "Press ENTER to Confirm..." to save your configuration, or press [ESC] to cancel.</p>		

User-Defined Address Mapping Sets

Now look at option 1 in menu 15.1. Enter 1 to bring up this menu. Look at the differences from the previous menu. Note the extra **Action** and **Select Rule** fields mean you can configure rules in this screen. Note also that the [?] in the **Set Name** field means that this is a required field and you must enter a name for the set.

The entire set will be deleted if you leave the Set Name field blank and press [ENTER] are the bottom of the screen.

```

Menu 15.1.1 - Address Mapping Rules

Set Name= NAT_SET

Idx  Local Start IP  Local End IP  Global Start IP  Global End IP  Type
---  -
1.
2.
3.
4.
5.
6.
7.
8.
9.
10.

Action= Edit          Select Rule=

Press ENTER to Confirm or ESC to Cancel:
    
```

Figure 30-6 Menu 15.1.1: First Set

The Type, Local and Global Start/End IPs are configured in menu 15.1.1.1 (described later) and the values are displayed here.

Ordering Your Rules

Ordering your rules is important because the ZyWALL applies the rules in the order that you specify. When a rule matches the current packet, the ZyWALL takes the corresponding action and the remaining rules are ignored. If there are any empty rules before your new configured rule, your configured rule will be pushed up by that number of empty rules. For example, if you have already configured rules 1 to 6 in your current set and now you configure rule number 9. In the set summary screen, the new rule will be rule 7, not 9. Now if you delete rule 4, rules 5 to 7 will be pushed up by 1 rule, so as old rule 5 becomes rule 4, old rule 6 becomes rule 5 and old rule 7 becomes rule 6.

Table 30-3 Fields in Menu 15.1.1

FIELD	DESCRIPTION	EXAMPLE
Set Name	Enter a name for this set of rules. This is a required field. If this field is left blank, the entire set will be deleted.	NAT_SET

Table 30-3 Fields in Menu 15.1.1

FIELD	DESCRIPTION	EXAMPLE
Action	The default is Edit . Edit means you want to edit a selected rule (see following field). Insert Before means to insert a rule before the rule selected. The rules after the selected rule will then be moved down by one rule. Delete means to delete the selected rule and then all the rules after the selected one will be advanced one rule. None disables the Select Rule item.	Edit
Select Rule	When you choose Edit , Insert Before or Delete in the previous field the cursor jumps to this field to allow you to select the rule to apply the action in question.	1

You must press [ENTER] at the bottom of the screen to save the whole set. You must do this again if you make any changes to the set – including deleting a rule. No changes to the set take place until this action is taken.

Selecting **Edit** in the **Action** field and then selecting a rule brings up the following menu, **Menu 15.1.1.1 - Address Mapping Rule** in which you can edit an individual rule and configure the **Type**, **Local** and **Global Start/End IPs**.

An IP End address must be numerically greater than its corresponding IP Start address.

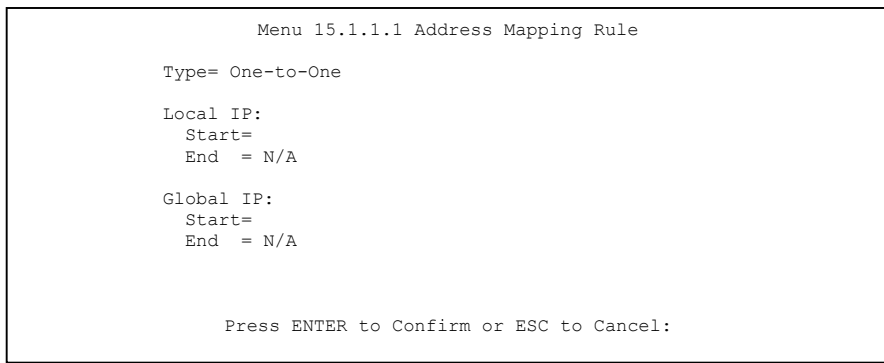

Figure 30-7 Menu 15.1.1.1: Editing/Configuring an Individual Rule in a Set

The following table describes the fields in this screen.

Table 30-4 Menu 15.1.1.1: Editing/Configuring an Individual Rule in a Set

FIELD	DESCRIPTION	EXAMPLE
Type	Press [SPACE BAR] and then [ENTER] to select from a total of five types. These are the mapping types discussed in the web configurator parts of this <i>User's Guide</i> . Server allows you to specify multiple servers of different types behind NAT to this computer. See <i>section 30.4.3</i> for an example.	One-to-One
Local IP	Only local IP fields are N/A for server; Global IP fields MUST be set for Server .	
Start	Enter the starting local IP address (ILA).	0.0.0.0
End	Enter the ending local IP address (ILA). If the rule is for all local IPs, then put the Start IP as 0.0.0.0 and the End IP as 255.255.255.255. This field is N/A for One-to-One and Server types.	N/A
Global IP		
Start	Enter the starting global IP address (IGA). If you have a dynamic IP, enter 0.0.0.0 as the Global IP Start . Note that Global IP Start can be set to 0.0.0.0 only if the types are Many-to-One or Server .	0.0.0.0
End	Enter the ending global IP address (IGA). This field is N/A for One-to-One , Many-to-One and Server types.	N/A
Once you have finished configuring a rule in this menu, press [ENTER] at the message "Press ENTER to Confirm..." to save your configuration, or press [ESC] to cancel.		

30.3 Configuring a Server behind NAT

Follow these steps to configure a server behind NAT:

- Step 1.** Enter 15 in the main menu to go to **Menu 15 - NAT Setup**.
- Step 2.** Enter 2 to go to **Menu 15.2 - NAT Server Setup**.
- Step 3.** Enter a port number in an unused **Start Port No** field. To forward only one port, enter it again in the **End Port No** field. To specify a range of ports, enter the last port to be forwarded in the **End Port No** field.
- Step 4.** Enter the inside IP address of the server in the **IP Address** field. In the following figure, you have a computer acting as an FTP, Telnet and SMTP server (ports 21, 23 and 25) at 192.168.1.33.

Step 5. Press [ENTER] at the “Press ENTER to confirm ...” prompt to save your configuration after you define all the servers or press [ESC] at any time to cancel.

Menu 15.2 - NAT Server Setup			
Rule	Start Port No.	End Port No.	IP Address
1.	Default	Default	0.0.0.0
2.	21	25	192.168.1.33
3.	0	0	0.0.0.0
4.	0	0	0.0.0.0
5.	0	0	0.0.0.0
6.	0	0	0.0.0.0
7.	0	0	0.0.0.0
8.	0	0	0.0.0.0
9.	0	0	0.0.0.0
10.	0	0	0.0.0.0
11.	0	0	0.0.0.0
12.	0	0	0.0.0.0

Press ENTER to Confirm or ESC to Cancel:

Figure 30-8 Menu 15.2: NAT Server Setup (ZyWALL 10W)

You assign the private network IP addresses. The NAT network appears as a single host on the Internet. A is the FTP/Telnet/SMTP server.

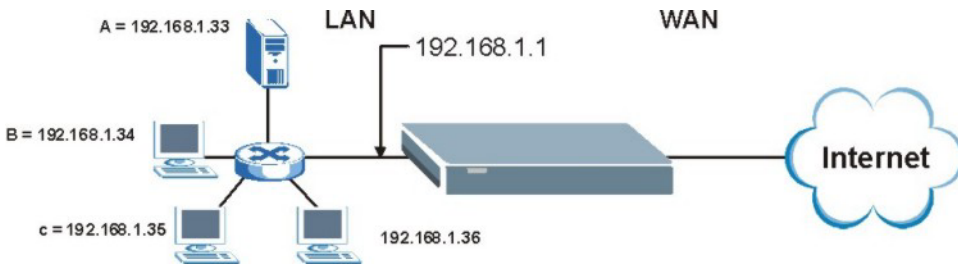

Figure 30-9 Server Behind NAT Example

30.4 General NAT Examples

The following are some examples of NAT configuration.

30.4.1 Internet Access Only

In the following Internet access example, you only need one rule where the ILAs (Inside Local Addresses) of computers A through D map to one dynamic IGA (Inside Global Address) assigned by your ISP.

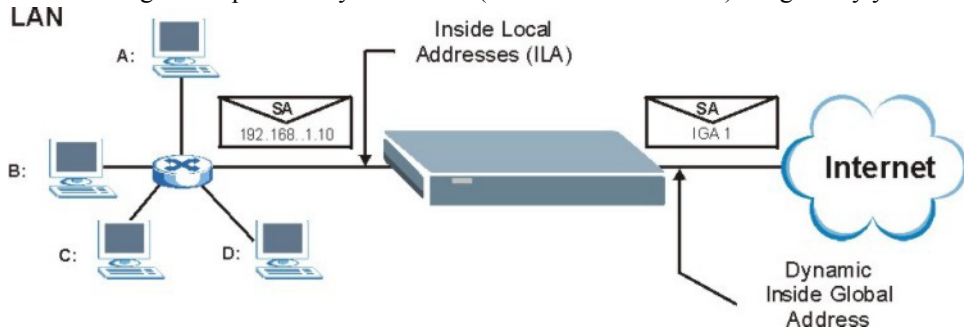

Figure 30-10 NAT Example 1

```

Menu 4 - Internet Access Setup

ISP's Name= ChangeMe
Encapsulation= Ethernet
Service Type= Standard
My Login= N/A
My Password= N/A
Retype to Confirm= N/A
Login Server= N/A
Relogin Every (min)= N/A
IP Address Assignment= Dynamic
IP Address= N/A
IP Subnet Mask= N/A
Gateway IP Address= N/A
Network Address Translation= SUA Only

Press ENTER to Confirm or ESC to Cancel:
Press ENTER to Confirm or ESC to Cancel:

```

Figure 30-11 Menu 4: Internet Access & NAT Example

From menu 4 shown above, simply choose the **SUA Only** option from the **Network Address Translation** field. This is the Many-to-One mapping discussed in *section 30.4*. The **SUA Only** read-only option from the **Network Address Translation** field in menus 4 and 11.3 is specifically pre-configured to handle this case.

30.4.2 Example 2: Internet Access with an Inside Server

The dynamic Inside Global Address is assigned by the ISP.

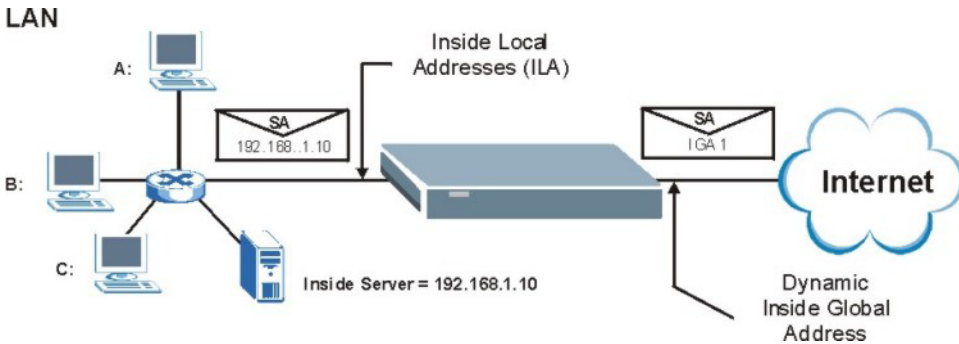

Figure 30-12 NAT Example 2

In this case, you do exactly as above (use the convenient pre-configured **SUA Only** set) and also go to menu 15.2 to specify the Inside Server behind the NAT as shown in the next figure.

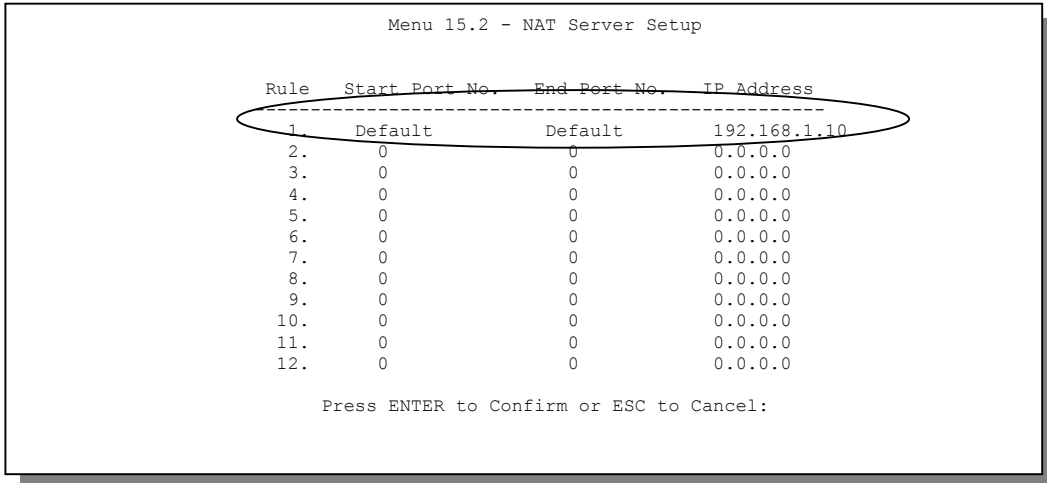

Figure 30-13 Menu 15.2: Specifying an Inside Server

30.4.3 Example 3: Multiple Public IP Addresses With Inside Servers

In this example, there are 3 IGAs from our ISP. There are many departments but two have their own FTP server. All departments share the same router. The example will reserve one IGA for each department with an FTP server and all departments use the other IGA. Map the FTP servers to the first two IGAs and the other LAN traffic to the remaining IGA. Map the third IGA to an inside web server and mail server. Four rules need to be configured, two bi-directional and two uni-directional as follows.

- Rule 1.** Map the first IGA to the first inside FTP server for FTP traffic in both directions (**1 : 1** mapping, giving both local and global IP addresses).
- Rule 2.** Map the second IGA to our second inside FTP server for FTP traffic in both directions (**1 : 1** mapping, giving both local and global IP addresses).
- Rule 3.** Map the other outgoing LAN traffic to IGA3 (**Many : 1** mapping).
- Rule 4.** You also map your third IGA to the web server and mail server on the LAN. Type **Server** allows you to specify multiple servers, of different types, to other computers behind NAT on the LAN.

The example situation looks somewhat like this:

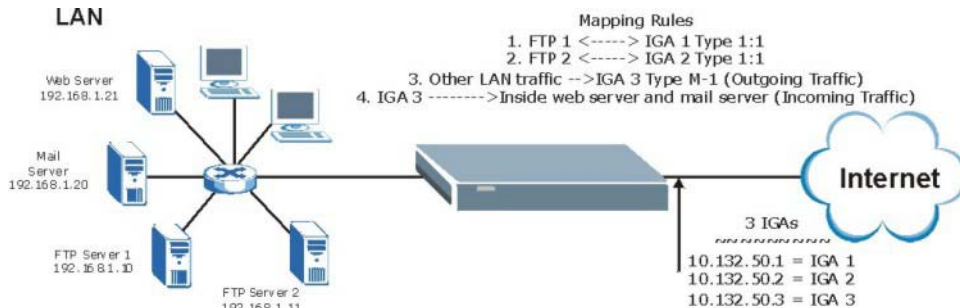

Figure 30-14 NAT Example 3

- Step 1.** In this case you need to configure Address Mapping Set 1 from **Menu 15.1 - Address Mapping Sets**. Therefore you must choose the **Full Feature** option from the **Network Address Translation** field (in menu 4 or menu 11.3) in *Figure 30-15*.
- Step 2.** Then enter 15 from the main menu.
- Step 3.** Enter 1 to configure the Address Mapping Sets.

- Step 4.** Enter 1 to begin configuring this new set. Enter a Set Name, choose the **Edit Action** and then enter 1 for the **Select Rule** field. Press [ENTER] to confirm.
- Step 5.** Select **Type** as **One-to-One** (direct mapping for packets going both ways), and enter the local **Start IP** as 192.168.1.10 (the IP address of FTP Server 1), the global **Start IP** as 10.132.50.1 (our first IGA). (See *Figure 30-16*).
- Step 6.** Repeat the previous step for rules 2 to 4 as outlined above.
- Step 7.** When finished, menu 15.1.1 should look like as shown in *Figure 30-17*.

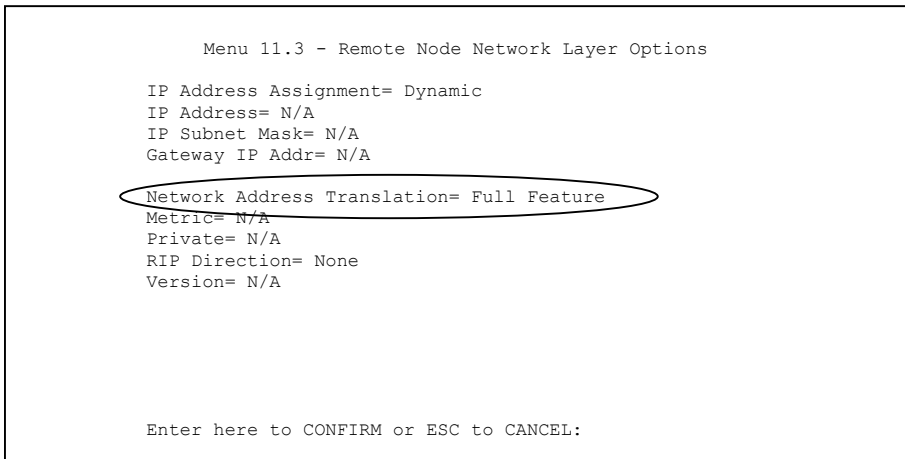

Figure 30-15 Example 3: Menu 11.3

The following figure shows how to configure the first rule.

```

Menu 15.1.1.1 Address Mapping Rule

Type= One-to-One

Local IP:
Start= 192.168.1.10
End = N/A

Global IP:
Start= 10.132.50.1
End = N/A

Press ENTER to Confirm or ESC to Cancel:

Press Space Bar to Toggle.
    
```

Figure 30-16 Example 3: Menu 15.1.1.1

```

Menu 15.1.1 - Address Mapping Rules

Set Name= Example3

Idx  Local Start IP  Local End IP  Global Start IP  Global End IP  Type
---  -
1.  192.168.1.10      10.132.50.1   1-1
2.  192.168.1.11     10.132.50.2   1-1
3.  0.0.0.0           255.255.255.255  10.132.50.3   M-1
4.                                     10.132.50.3   Server
5.
6.
7.
8.
9.
10.

Action= Edit      Select Rule=

Press ENTER to Confirm or ESC to Cancel:
    
```

Figure 30-17 Example 3: Final Menu 15.1.1

Now configure the IGA3 to map to our web server and mail server on the LAN.

Step 8. Enter 15 from the main menu.

Step 9. Now enter 2 from this menu and configure it as shown in *Figure 30-18*.

Menu 15.2 - NAT Server Setup

Rule	Start Port No.	End Port No.	IP Address
1.	Default	Default	0.0.0.0
2.	80	80	192.168.1.21
3.	25	25	192.168.1.20
4.	0	0	0.0.0.0
5.	0	0	0.0.0.0
6.	0	0	0.0.0.0
7.	0	0	0.0.0.0
8.	0	0	0.0.0.0
9.	0	0	0.0.0.0
10.	0	0	0.0.0.0
11.	0	0	0.0.0.0
12.	0	0	0.0.0.0

Press ENTER to Confirm or ESC to Cancel:

Figure 30-18 Example 3: Menu 15.2

30.4.4 Example 4: NAT Unfriendly Application Programs

Some applications do not support NAT Mapping using TCP or UDP port address translation. In this case it is better to use **Many-One-to-One** mapping as port numbers do *not* change for **Many-One-to-One** (and **One-to-One**) NAT mapping types. The following figure illustrates this.

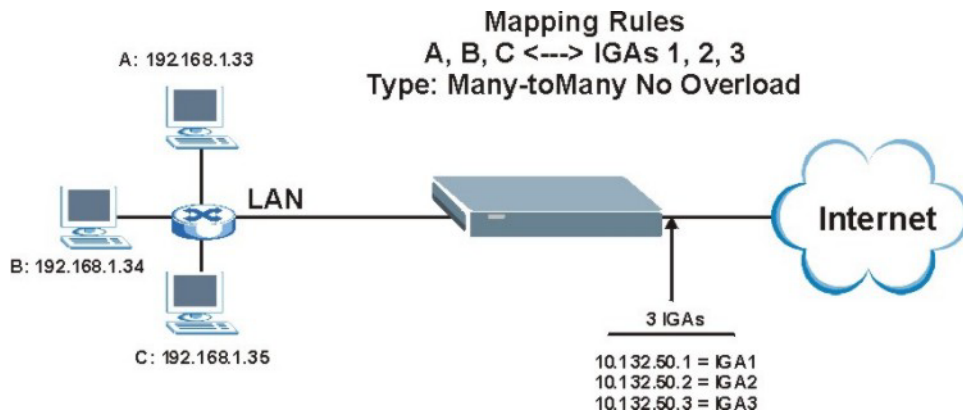

Figure 30-19 NAT Example 4

Other applications such as some gaming programs are NAT unfriendly because they embed addressing information in the data stream. These applications won't work through NAT even when using One-to-One and Many-One-to-One mapping types.

Follow the steps outlined in example 3 above to configure these two menus as follows.

```
Menu 15.1.1.1 Address Mapping Rule

Type= Many-One-to-One

Local IP:
  Start= 192.168.1.10
  End   = 192.168.1.12

Global IP:
  Start= 10.132.50.1
  End   = 10.132.50.3

Press ENTER to Confirm or ESC to Cancel:
```

Figure 30-20 Example 4: Menu 15.1.1.1: Address Mapping Rule

After you've configured your rule, you should be able to check the settings in menu 15.1.1 as shown next.

```
Menu 15.1.1 - Address Mapping Rules

Set Name= Example4

Idx  Local Start IP  Local End IP  Global Start IP  Global End IP  Type
---  -
1.   192.168.1.10    192.168.1.12  10.132.50.1     10.132.50.3   M-1-1
2.
3.
4.
5.
6.
7.
8.
9.
10.

Action= Edit      Select Rule=

Press ENTER to Confirm or ESC to Cancel:
```

Figure 30-21 Example 4: Menu 15.1.1: Address Mapping Rules

30.5 Configuring Trigger Port Forwarding

Only one LAN computer can use a trigger port (range) at a time.

Enter 3 in menu 15 to display **Menu 15.3 — Trigger Port Setup**, shown next.

Menu 15.3 - Trigger Port Setup

Rule	Name	Incoming Start Port	End Port	Trigger Start Port	End Port
1.	Real Audio	6970	7170	7070	7070
2.		0	0	0	0
3.		0	0	0	0
4.		0	0	0	0
5.		0	0	0	0
6.		0	0	0	0
7.		0	0	0	0
8.		0	0	0	0
9.		0	0	0	0
10.		0	0	0	0
11.		0	0	0	0
12.		0	0	0	0

Press ENTER to Confirm or ESC to Cancel:

Figure 30-22 Menu 15.3: Trigger Port Setup

The following table describes the fields in this screen.

Table 30-5 Menu 15.3: Trigger Port Setup Description

FIELD	DESCRIPTION	EXAMPLE
Rule	This is the rule index number.	1
Name	Enter a unique name for identification purposes. You may enter up to 15 characters in this field. All characters are permitted - including spaces.	Real Audio
Incoming	Incoming is a port (or a range of ports) that a server on the WAN uses when it sends out a particular service. The ZyWALL forwards the traffic with this port (or range of ports) to the client computer on the LAN that requested the service.	
Start Port	Enter a port number or the starting port number in a range of port numbers.	6970
End Port	Enter a port number or the ending port number in a range of port numbers.	7170
Trigger	The trigger port is a port (or a range of ports) that causes (or triggers) the ZyWALL to record the IP address of the LAN computer that sent the traffic to a server on the WAN.	
Start Port	Enter a port number or the starting port number in a range of port numbers.	7070
End Port	Enter a port number or the ending port number in a range of port numbers.	7070
Press [ENTER] at the message "Press ENTER to Confirm..." to save your configuration, or press [ESC] at any time to cancel.		

Chapter 31

Introducing the ZyWALL Firewall

This chapter shows you how to get started with the ZyWALL firewall.

31.1 Using ZyWALL SMT Menus

From the main menu enter 21 to go to **Menu 21 - Filter Set and Firewall Configuration** to display the screen shown next.

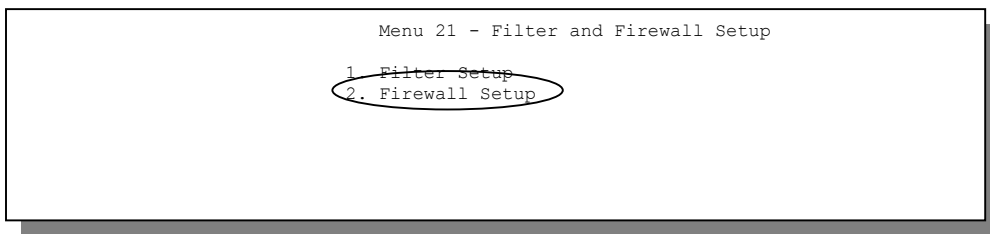

Figure 31-1 Menu 21: Filter and Firewall Setup

31.1.1 Activating the Firewall

Enter option 2 in this menu to bring up the following screen. Press [SPACE BAR] and then [ENTER] to select **Yes** in the **Active** field to activate the firewall. The firewall must be active to protect against Denial of Service (DoS) attacks. Use the web configurator to configure firewall rules. This screen varies by ZyWALL model.

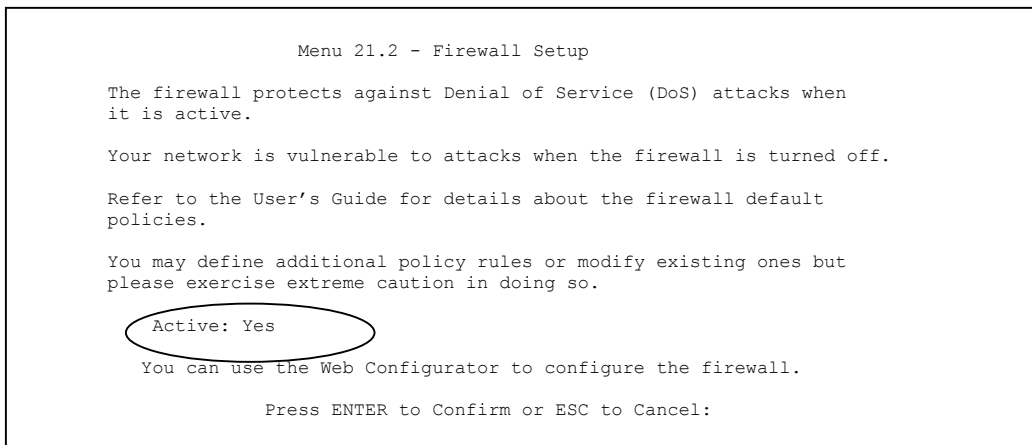

Figure 31-2 Menu 21.2: Firewall Setup

Configure the firewall rules using the web configurator or CLI commands.

Chapter 32

Filter Configuration

This chapter shows you how to create and apply filters.

32.1 Introduction to Filters

Your ZyWALL uses filters to decide whether to allow passage of a data packet and/or to make a call. There are two types of filter applications: data filtering and call filtering. Filters are subdivided into device and protocol filters, which are discussed later.

Data filtering screens the data to determine if the packet should be allowed to pass. Data filters are divided into incoming and outgoing filters, depending on the direction of the packet relative to a port. Data filtering can be applied on either the WAN side or the LAN side. Call filtering is used to determine if a packet should be allowed to trigger a call. Remote node call filtering is only applicable when using PPPoE encapsulation. Outgoing packets must undergo data filtering before they encounter call filtering as shown in the following figure.

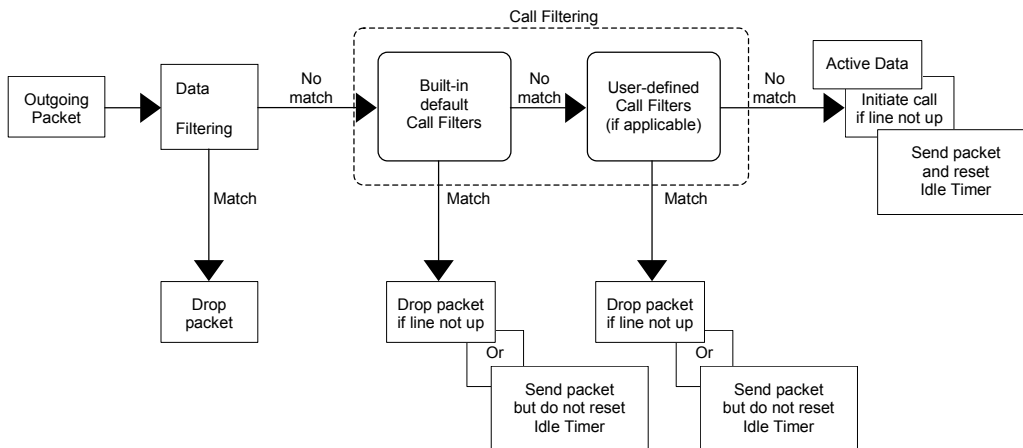

Figure 32-1 Outgoing Packet Filtering Process

For incoming packets, your ZyWALL applies data filters only. Packets are processed depending upon whether a match is found. The following sections describe how to configure filter sets.

32.1.1 The Filter Structure of the ZyWALL

A filter set consists of one or more filter rules. Usually, you would group related rules, e.g., all the rules for NetBIOS, into a single set and give it a descriptive name. The ZyWALL allows you to configure up to twelve filter sets with six rules in each set, for a total of 72 filter rules in the system. You cannot mix device filter rules and protocol filter rules within the same set. You can apply up to four filter sets to a particular port to block multiple types of packets. With each filter set having up to six rules, you can have a maximum of 24 rules active for a single port.

Sets of factory default filter rules have been configured in menu 21 to prevent NetBIOS traffic from triggering calls and to prevent incoming telnet sessions. A summary of their filter rules is shown in the figures that follow.

The following figure illustrates the logic flow when executing a filter rule. See also *Figure 32-7* for the logic flow when executing an IP filter.

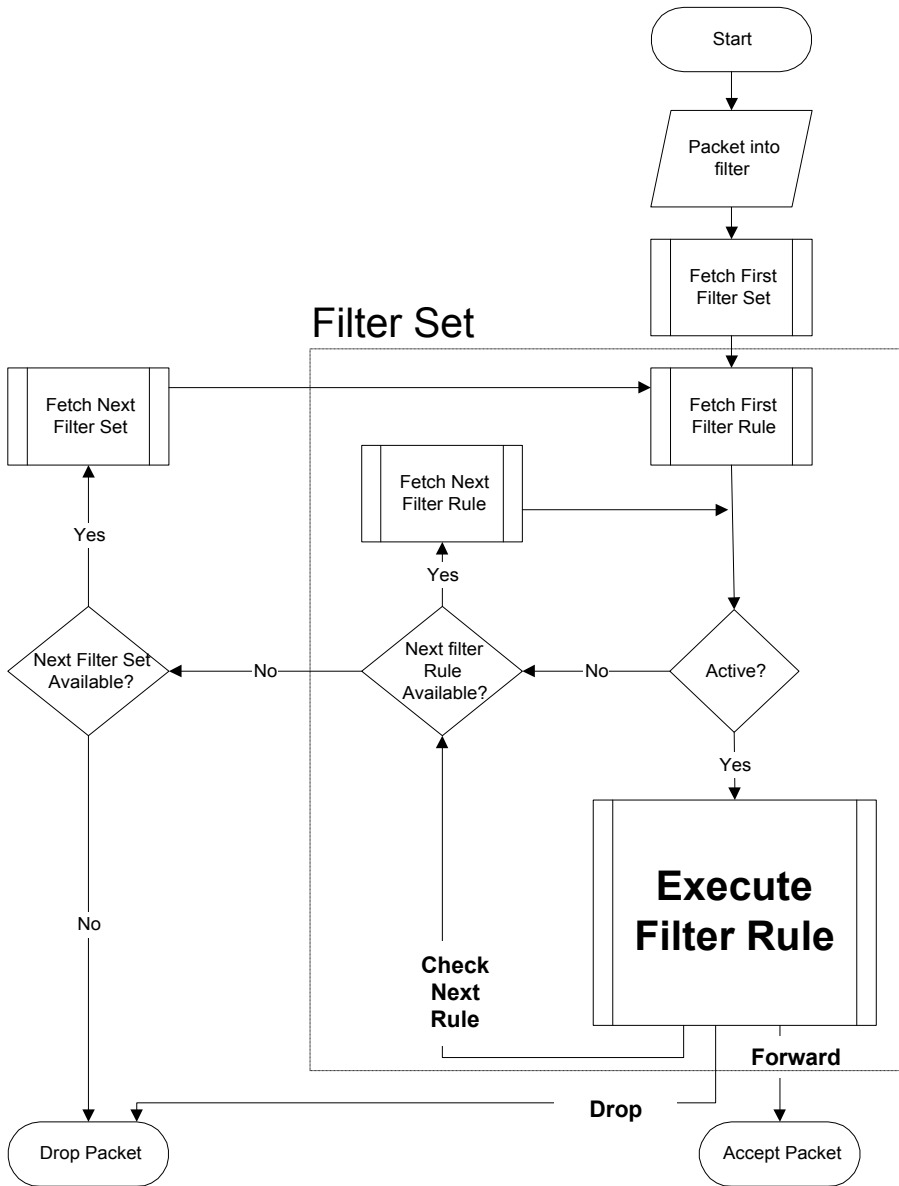

Figure 32-2 Filter Rule Process

You can apply up to four filter sets to a particular port to block multiple types of packets. With each filter set having up to six rules, you can have a maximum of 24 rules active for a single port.

32.2 Configuring a Filter Set

The ZyWALL includes filtering for NetBIOS over TCP/IP packets by default. To configure another filter set, follow the procedure below.

Step 1. Enter 21 in the main menu to open menu 21.

```
Menu 21 - Filter and Firewall Setup

1. Filter Setup
2. Firewall Setup

Enter Menu Selection Number:
```

Figure 32-4 Menu 21: Filter and Firewall Setup

Step 2. Enter 1 to bring up the following menu.

```
Menu 21.1 - Filter Set Configuration

Filter Set #      Comments      Filter Set #      Comments
-----
1      _____      7      _____
2      _____      8      _____
3      _____      9      _____
4      _____     10     _____
5      _____     11     _____
6      _____     12     _____

Enter Filter Set Number to Configure= 0

Edit Comments= N/A

Press ENTER to Confirm or ESC to Cancel:
```

Figure 32-5 Menu 21.1: Filter Set Configuration

Step 3. Select the filter set you wish to configure (1-12) and press [ENTER].

Step 4. Enter a descriptive name or comment in the **Edit Comments** field and press [ENTER].

Step 5. Press [ENTER] at the message [Press ENTER to confirm] to open **Menu 21.1.1 - Filter Rules Summary**.

This screen shows the summary of the existing rules in the filter set. The following tables contain a brief description of the abbreviations used in the previous menus.

Table 32-1 Abbreviations Used in the Filter Rules Summary Menu

FIELD	DESCRIPTION
#	The filter rule number: 1 to 6.
A	Active: "Y" means the rule is active. "N" means the rule is inactive.
Type	The type of filter rule: "GEN" for Generic, "IP" for TCP/IP.
Filter Rules	These parameters are displayed here.
M	<p>More.</p> <p>"Y" means there are more rules to check which form a rule chain with the present rule. An action cannot be taken until the rule chain is complete.</p> <p>"N" means there are no more rules to check. You can specify an action to be taken i.e., forward the packet, drop the packet or check the next rule. For the latter, the next rule is independent of the rule just checked.</p>
m	<p>Action Matched.</p> <p>"F" means to forward the packet immediately and skip checking the remaining rules.</p> <p>"D" means to drop the packet.</p> <p>"N" means to check the next rule.</p>
n	<p>Action Not Matched.</p> <p>"F" means to forward the packet immediately and skip checking the remaining rules.</p> <p>"D" means to drop the packet.</p> <p>"N" means to check the next rule.</p>

The protocol dependent filter rules abbreviation are listed as follows:

Table 32-2 Rule Abbreviations Used

ABBREVIATION	DESCRIPTION
IP	Pr Protocol
	SA Source Address
	SP Source Port number
	DA Destination Address
	DP Destination Port number
GEN	Off Offset
	Len Length

Refer to the next section for information on configuring the filter rules.

32.2.1 Configuring a Filter Rule

To configure a filter rule, type its number in **Menu 21.1.1 - Filter Rules Summary** and press [ENTER] to open menu 21.1.1.1 for the rule.

To speed up filtering, all rules in a filter set must be of the same class, i.e., protocol filters or generic filters. The class of a filter set is determined by the first rule that you create. When applying the filter sets to a port, separate menu fields are provided for protocol and device filter sets. If you include a protocol filter set in a device filter field or vice versa, the ZyWALL will warn you and will not allow you to save.

32.2.2 Configuring a TCP/IP Filter Rule

This section shows you how to configure a TCP/IP filter rule. TCP/IP rules allow you to base the rule on the fields in the IP and the upper layer protocol, for example, UDP and TCP headers.

To configure TCP/IP rules, select **TCP/IP Filter Rule** from the **Filter Type** field and press [ENTER] to open **Menu 21.1.1.1 - TCP/IP Filter Rule**, as shown next.

```

Menu 21.1.1.1 - TCP/IP Filter Rule

Filter #: 1,1
Filter Type= TCP/IP Filter Rule
Active= Yes
IP Protocol= 0          IP Source Route= No
Destination: IP Addr= 0.0.0.0
              IP Mask= 0.0.0.0
              Port # = 137
              Port # Comp= Equal
Source: IP Addr= 0.0.0.0
        IP Mask= 0.0.0.0
        Port # =
        Port # Comp= None

TCP Estab= No
More= N/A          Log= None
Action Matched= Drop
Action Not Matched= Check Next Rule

Press ENTER to Confirm or ESC to Cancel:
Press Space Bar to Toggle.

```

Figure 32-6 Menu 21.1.1.1: TCP/IP Filter Rule

The following table describes how to configure your TCP/IP filter rule.

Table 32-3 TCP/IP Filter Rule Menu Fields

FIELD	DESCRIPTION	OPTIONS
Active	Press [SPACE BAR] and then [ENTER] to select Yes to activate the filter rule or No to deactivate it.	Yes No
IP Protocol	Protocol refers to the upper layer protocol, e.g., TCP is 6, UDP is 17 and ICMP is 1. Type a value between 0 and 255. A value of 0 matches ANY protocol.	0-255
IP Source Route	Press [SPACE BAR] and then [ENTER] to select Yes to apply the rule to packets with an IP source route option. Otherwise the packets must not have a source route option. The majority of IP packets do not have source route.	Yes No
Destination		
IP Address	Enter the destination IP Address of the packet you wish to filter. This field is ignored if it is 0.0.0.0.	0.0.0.0
IP Mask	Enter the IP mask to apply to the Destination: IP Addr.	0.0.0.0

Table 32-3 TCP/IP Filter Rule Menu Fields

FIELD	DESCRIPTION	OPTIONS
Port #	Enter the destination port of the packets that you wish to filter. The range of this field is 0 to 65535. This field is ignored if it is 0.	0-65535
Port # Comp	Press [SPACE BAR] and then [ENTER] to select the comparison to apply to the destination port in the packet against the value given in Destination: Port # .	None Less Greater Equal Not Equal
Source		
IP Address	Enter the source IP Address of the packet you wish to filter. This field is ignored if it is 0.0.0.0.	0.0.0.0
IP Mask	Enter the IP mask to apply to the Source: IP Addr .	0.0.0.0
Port #	Enter the source port of the packets that you wish to filter. The range of this field is 0 to 65535. This field is ignored if it is 0.	0-65535
Port # Comp	Press [SPACE BAR] and then [ENTER] to select the comparison to apply to the source port in the packet against the value given in Source: Port # .	None Less Greater Equal Not Equal
TCP Estab	This field is applicable only when the IP Protocol field is 6, TCP. Press [SPACE BAR] and then [ENTER] to select Yes , to have the rule match packets that want to establish a TCP connection (SYN=1 and ACK=0); if No , it is ignored.	Yes No
More	Press [SPACE BAR] and then [ENTER] to select Yes or No . If Yes , a matching packet is passed to the next filter rule before an action is taken; if No , the packet is disposed of according to the action fields. If More is Yes , then Action Matched and Action Not Matched will be N/A .	Yes No

Table 32-3 TCP/IP Filter Rule Menu Fields

FIELD	DESCRIPTION	OPTIONS
Log	Press [SPACE BAR] and then [ENTER] to select a logging option from the following: None – No packets will be logged. Action Matched - Only packets that match the rule parameters will be logged. Action Not Matched - Only packets that do not match the rule parameters will be logged. Both – All packets will be logged.	None Action Matched Action Not Matched Both
Action Matched	Press [SPACE BAR] and then [ENTER] to select the action for a matching packet.	Check Next Rule Forward Drop
Action Not Matched	Press [SPACE BAR] and then [ENTER] to select the action for a packet not matching the rule.	Check Next Rule Forward Drop
When you have Menu 21.1.1.1 - TCP/IP Filter Rule configured, press [ENTER] at the message “Press ENTER to Confirm” to save your configuration, or press [ESC] to cancel. This data will now be displayed on Menu 21.1.1 - Filter Rules Summary .		

The following figure illustrates the logic flow of an IP filter.

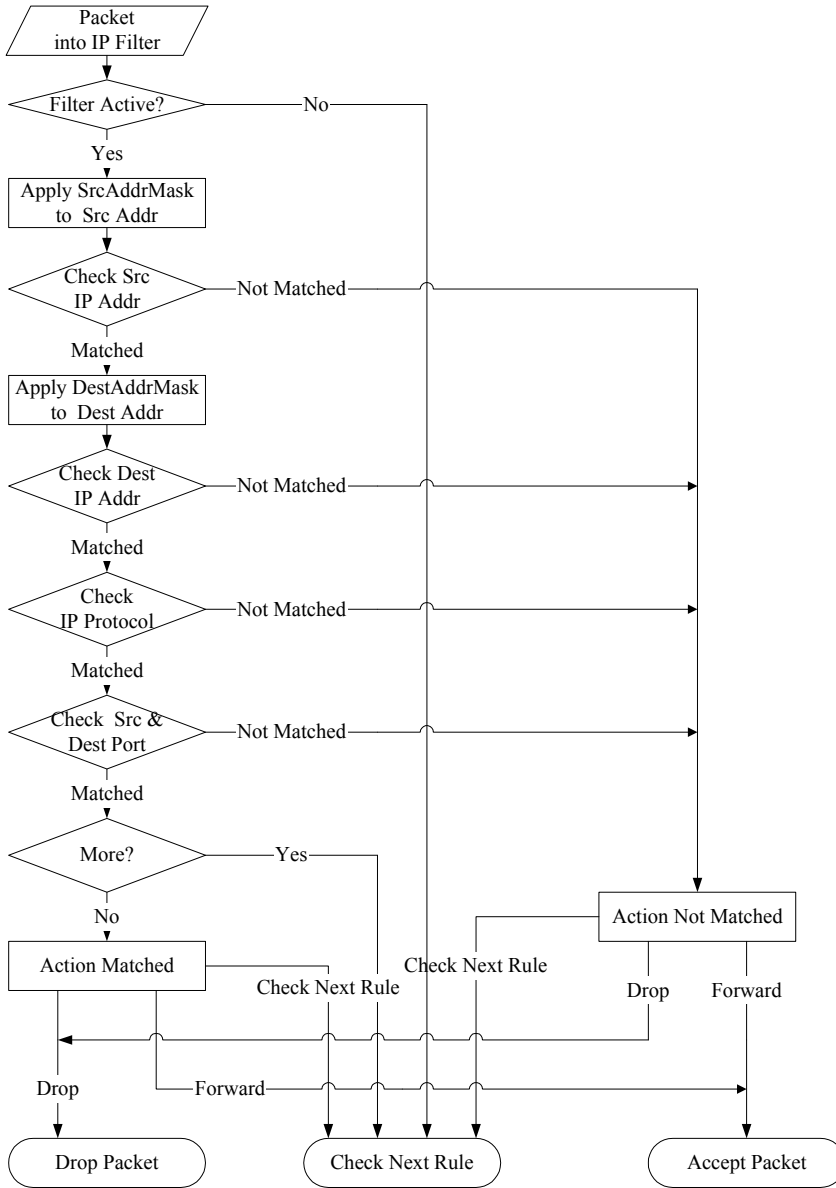

Figure 32-7 Executing an IP Filter

32.2.3 Configuring a Generic Filter Rule

This section shows you how to configure a generic filter rule. The purpose of generic rules is to allow you to filter non-IP packets. For IP, it is generally easier to use the IP rules directly.

For generic rules, the ZyWALL treats a packet as a byte stream as opposed to an IP or IPX packet. You specify the portion of the packet to check with the **Offset** (from 0) and the **Length** fields, both in bytes. The ZyWALL applies the Mask (bit-wise ANDing) to the data portion before comparing the result against the Value to determine a match. The **Mask** and **Value** are specified in hexadecimal numbers. Note that it takes two hexadecimal digits to represent a byte, so if the length is 4, the value in either field will take 8 digits, for example, FFFFFFFF.

To configure a generic rule, select **Generic Filter Rule** in the **Filter Type** field in menu 21.1.4.1 and press [ENTER] to open Generic Filter Rule, as shown below.

```

Menu 21.1.4.1 - Generic Filter Rule

Filter #: 4,1
Filter Type= Generic Filter Rule
Active= No
Offset= 0
Length= 0
Mask= N/A
Value= N/A
More= No           Log= None
Action Matched= Check Next Rule
Action Not Matched= Check Next Rule

Press ENTER to Confirm or ESC to Cancel:
Press Space Bar to Toggle.

```

Figure 32-8 Menu 21.1.4.1: Generic Filter Rule

The following table describes the fields in the Generic Filter Rule menu.

Table 32-4 Generic Filter Rule Menu Fields

FIELD	DESCRIPTION	OPTIONS
Filter #	This is the filter set, filter rule co-ordinates, i.e., 2,3 refers to the second filter set and the third rule of that set.	

Table 32-4 Generic Filter Rule Menu Fields

FIELD	DESCRIPTION	OPTIONS
Filter Type	Use [SPACE BAR] and then [ENTER] to select a rule type. Parameters displayed below each type will be different. TCP/IP filter rules are used to filter IP packets while generic filter rules allow filtering of non-IP packets.	Generic Filter Rule TCP/IP Filter Rule
Active	Select Yes to turn on the filter rule or No to turn it off.	Yes / No
Offset	Enter the starting byte of the data portion in the packet that you wish to compare. The range for this field is from 0 to 255.	0-255
Length	Enter the byte count of the data portion in the packet that you wish to compare. The range for this field is 0 to 8.	0-8
Mask	Enter the mask (in Hexadecimal notation) to apply to the data portion before comparison.	
Value	Enter the value (in Hexadecimal notation) to compare with the data portion.	
More	If Yes , a matching packet is passed to the next filter rule before an action is taken; else the packet is disposed of according to the action fields. If More is Yes , then Action Matched and Action Not Matched will be No .	Yes No
Log	Select the logging option from the following: None - No packets will be logged. Action Matched - Only packets that match the rule parameters will be logged. Action Not Matched - Only packets that do not match the rule parameters will be logged. Both - All packets will be logged.	None Action Matched Action Not Matched Both
Action Matched	Select the action for a packet matching the rule.	Check Next Rule Forward Drop
Action Not Matched	Select the action for a packet not matching the rule.	Check Next Rule Forward Drop
Once you have completed filling in Menu 21.4.1.1 - Generic Filter Rule , press [ENTER] at the message "Press ENTER to Confirm" to save your configuration, or press [ESC] to cancel. This data will now be displayed on Menu 21.1.1 - Filter Rules Summary .		

32.3 Example Filter

Let's look at an example to block outside users from accessing the ZyWALL via telnet.

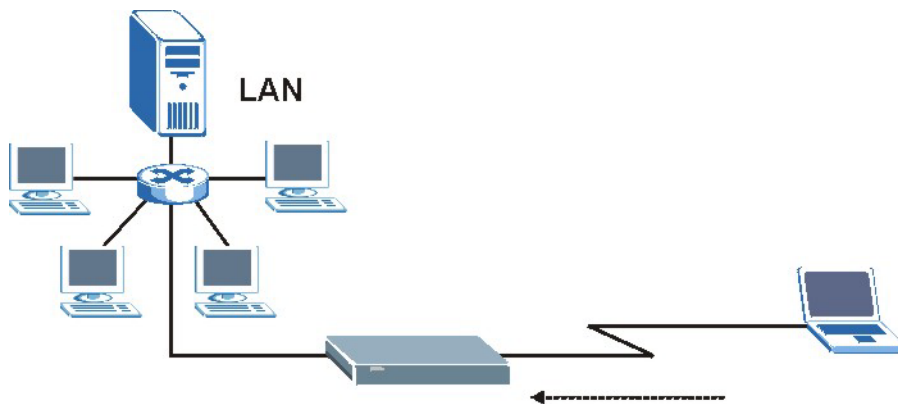

Figure 32-9 Telnet Filter Example

- Step 1.** Enter 21 from the main menu to open **Menu 21 - Filter and Firewall Setup**.
- Step 2.** Enter 1 to open **Menu 21.1 - Filter Set Configuration**.
- Step 3.** Enter the index of the filter set you wish to configure (say 3) and press [ENTER].
- Step 4.** Enter a descriptive name or comment in the **Edit Comments** field and press [ENTER].
- Step 5.** Press [ENTER] at the message [Press ENTER to confirm] to open **Menu 21.1.3 - Filter Rules Summary**.

Step 6. Enter 1 to configure the first filter rule (the only filter rule of this set). Make the entries in this menu as shown in the following figure.

The screenshot shows the configuration menu for a TCP/IP Filter Rule. The menu text is as follows:

```

Menu 21.1.3.1 - TCP/IP Filter Rule

Filter #: 3,1
Filter Type= TCP/IP Filter Rule
Active= Yes
IP Protocol= 6      IP Source Route= No
Destination: IP Addr= 0.0.0.0
                IP Mask= 0.0.0.0
                Port # = 23
                Port # Comp= Equal
Source: IP Addr= 0.0.0.0
                IP Mask= 0.0.0.0
                Port # = 0
                Port # Comp= None
TCP Estab= No
More= No           Log= None
Action Matched= Drop
Action Not Matched= Forward

Press ENTER to Confirm or ESC to Cancel:
Press Space Bar to Toggle.
    
```

Callout boxes provide the following explanations:

- Press [SPACE BAR] and then [ENTER] to choose this filter rule type. The first filter rule type determines all subsequent filter types within a set.** (Points to the menu title)
- Select **Yes** to make the rule active.** (Points to Active= Yes)
- 6 is the TCP protocol.** (Points to IP Protocol= 6)
- The port number for the telnet service (TCP protocol) is 23. See RFC 1060 for port numbers of well-known services.** (Points to Port # = 23)
- Select **Equal** here as you are looking for packets going to port 23 only.** (Points to Port # Comp= Equal)
- Select **Drop** here so that the packet will be dropped if its destination is the telnet port.** (Points to Action Matched= Drop)
- Select **Forward** here so that the packet will be forwarded if its destination is not the telnet port.** (Points to Action Not Matched= Forward)
- There are no more rules to check.** (Points to Press Space Bar to Toggle.)

Figure 32-10 Example Filter: Menu 21.1.3.1

When you press [ENTER] to confirm, you will see the following screen. Note that there is only one filter rule in this set.

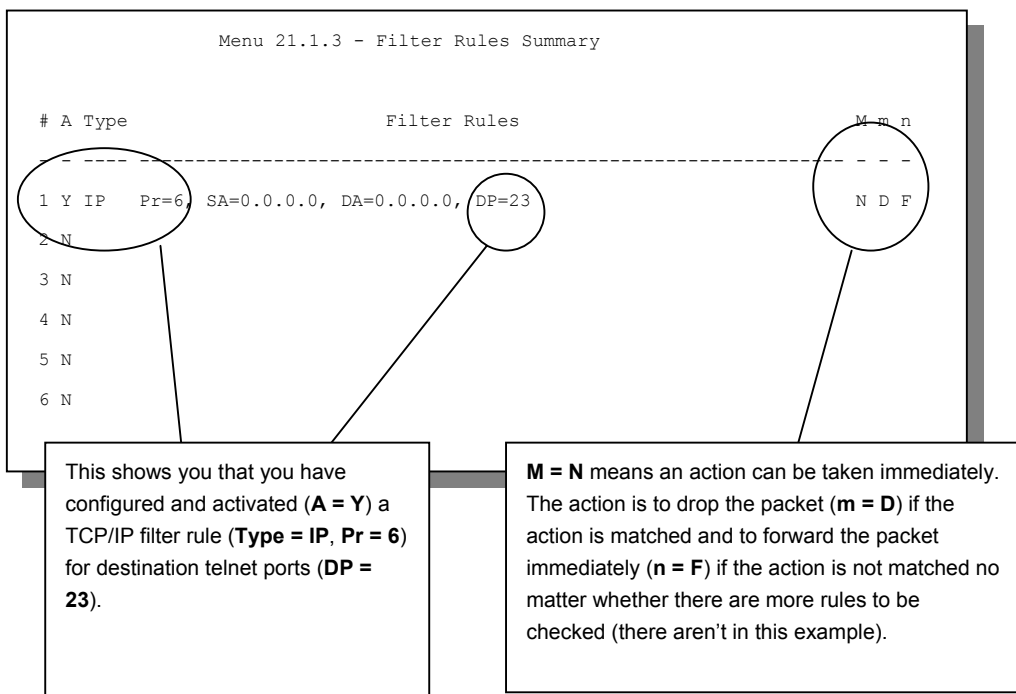

Figure 32-11 Example Filter Rules Summary: Menu 21.1.3

After you've created the filter set, you must apply it.

- Step 1.** Enter 11 from the main menu to go to menu 11.
- Step 2.** Go to the **Edit Filter Sets** field, press [SPACE BAR] to select **Yes** and press [ENTER].
- Step 3.** This brings you to menu 11.5. Apply a filter set (our example filter set 3) as shown in *Figure 32-15*.
- Step 4.** Press [ENTER] to confirm after you enter the set numbers and to leave menu 11.5.

32.4 Filter Types and NAT

There are two classes of filter rules, **Generic Filter** (Device) rules and protocol filter (**TCP/IP**) rules. Generic filter rules act on the raw data from/to LAN and WAN. Protocol filter rules act on the IP packets. Generic and TCP/IP filter rules are discussed in more detail in the next section. When NAT (Network

Address Translation) is enabled, the inside IP address and port number are replaced on a connection-by-connection basis, which makes it impossible to know the exact address and port on the wire. Therefore, the ZyWALL applies the protocol filters to the “native” IP address and port number before NAT for outgoing packets and after NAT for incoming packets. On the other hand, the generic, or device filters are applied to the raw packets that appear on the wire. They are applied at the point when the ZyWALL is receiving and sending the packets; i.e. the interface. The interface can be an Ethernet port or any other hardware port. The following diagram illustrates this.

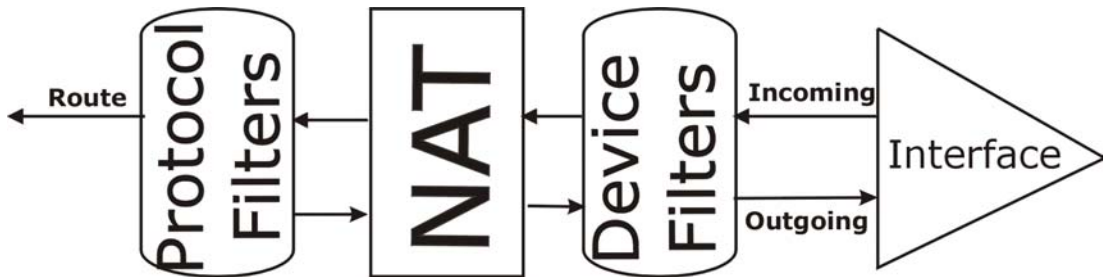

Figure 32-12 Protocol and Device Filter Sets

32.5 Firewall Versus Filters

Firewall configuration is discussed in the *firewall* chapters of this manual. Further comparisons are also made between filtering, NAT and the firewall.

32.6 Applying a Filter

This section shows you where to apply the filter(s) after you design it (them). The ZyWALL already has filters to prevent NetBIOS traffic from triggering calls, and block incoming telnet, FTP and HTTP connections.

If you do not activate the firewall, it is advisable to apply filters.

32.6.1 Applying LAN Filters

LAN traffic filter sets may be useful to block certain packets, reduce traffic and prevent security breaches. Go to menu 3.1 (shown next) and enter the number(s) of the filter set(s) that you want to apply as appropriate. You can choose up to four filter sets (from twelve) by entering their numbers separated by commas, e.g., 3, 4, 6, 11. Input filter sets filter incoming traffic to the ZyWALL and output filter sets filter outgoing traffic from the ZyWALL. For PPPoE or PPTP encapsulation, you have the additional option of specifying remote node call filter sets.

```
Menu 3.1 - LAN Port Filter Setup

Input Filter Sets:
  protocol filters=
  device filters=
Output Filter Sets:
  protocol filters=
  device filters=

Press ENTER to Confirm or ESC to Cancel:
```

Figure 32-13 Filtering LAN Traffic

32.6.2 Applying DMZ Filters

DMZ traffic filter sets may be useful to block certain packets, reduce traffic and prevent security breaches. Go to menu 5.1 (shown next) and enter the number(s) of the filter set(s) that you want to apply as appropriate. You can choose up to four filter sets (from twelve) by entering their numbers separated by commas, e.g., 3, 4, 6, 11. Input filter sets filter incoming traffic to the ZyWALL and output filter sets filter outgoing traffic from the ZyWALL. The ZyWALL already has filters to prevent NetBIOS traffic from triggering calls, and block incoming telnet, FTP and HTTP connections. The DMZ port is not available on all models.

```
Menu 5.1 - DMZ Port Filter Setup

Input Filter Sets:
  protocol filters=
  device filters=
Output Filter Sets:
  protocol filters=
  device filters=

Press ENTER to Confirm or ESC to Cancel:
```

Figure 32-14 Filtering DMZ Traffic

32.6.3 Applying Remote Node Filters

Go to menu 11.5 (shown below – note that call filter sets are only present for PPPoE encapsulation) and enter the number(s) of the filter set(s) as appropriate. You can cascade up to four filter sets by entering their numbers separated by commas. The ZyWALL already has filters to prevent NetBIOS traffic from triggering calls, and block incoming telnet, FTP and HTTP connections.

```
Menu 11.5 - Remote Node Filter Setup

Input Filter Sets:
  protocol filters=
  device filters=
Output Filter Sets:
  protocol filters=
  device filters=

Press ENTER to Confirm or ESC to Cancel:
```

Figure 32-15 Filtering Remote Node Traffic

Chapter 33

SNMP Configuration

This chapter explains SNMP configuration menu 22.

SNMP is only available if TCP/IP is configured.

33.1 SNMP Configuration

To configure SNMP, enter 22 from the main menu to display **Menu 22 - SNMP Configuration** as shown next. The “community” for **Get**, **Set** and **Trap** fields is SNMP terminology for password.

```

Menu 22 - SNMP Configuration

SNMP:
  Get Community= public
  Set Community= public
  Trusted Host= 0.0.0.0
  Trap:
    Community= public
    Destination= 0.0.0.0

Press ENTER to Confirm or ESC to Cancel:

```

Figure 33-1 Menu 22: SNMP Configuration

The following table describes the SNMP configuration parameters.

Table 33-1 SNMP Configuration Menu Fields

FIELD	DESCRIPTION	EXAMPLE
Get Community	Type the Get community, which is the password for the incoming Get- and GetNext requests from the management station.	Public
Set Community	Type the Set community, which is the password for incoming Set requests from the management station.	Public
Trusted Host	If you enter a trusted host, your ZyWALL will only respond to SNMP messages from this address. A blank (default) field means your ZyWALL will respond to all SNMP messages it receives, regardless of source.	0.0.0.0

Table 33-1 SNMP Configuration Menu Fields

FIELD	DESCRIPTION	EXAMPLE
Trap Community	Type the Trap community, which is the password sent with each trap to the SNMP manager.	Public
Destination	Type the IP address of the station to send your SNMP traps to.	0.0.0.0

When you have completed this menu, press [ENTER] at the prompt "Press [ENTER] to confirm or [ESC] to cancel" to save your configuration or press [ESC] to cancel and go back to the previous screen.

33.2 SNMP Traps

The ZyWALL will send traps to the SNMP manager when any one of the following events occurs:

Table 33-2 SNMP Traps

TRAP #	TRAP NAME	DESCRIPTION
0	coldStart (defined in <i>RFC-1215</i>)	A trap is sent after booting (power on).
1	warmStart (defined in <i>RFC-1215</i>)	A trap is sent after booting (software reboot).
4	authenticationFailure (defined in <i>RFC-1215</i>)	A trap is sent to the manager when receiving any SNMP get or set requirements with the wrong community (password).
6	whyReboot (defined in ZYXEL-MIB)	A trap is sent with the reason of restart before rebooting when the system is going to restart (warm start).
6a	For intentional reboot:	A trap is sent with the message "System reboot by user!" if reboot is done intentionally, (for example, download new files, C1 command "sys reboot", etc.).
6b	For fatal error:	A trap is sent with the message of the fatal code if the system reboots because of fatal errors.

Part XIII:

SMT System Maintenance

This part covers system information and diagnosis, firmware and configuration file maintenance, as well as providing information on the system maintenance and information functions and how to configure remote management.

See the web configurator parts of this guide for background information on features configurable by web configurator and SMT.

Chapter 34

System Information & Diagnosis

This chapter covers SMT menus 24.1 to 24.4.

34.1 Introduction to System Status

This chapter covers the diagnostic tools that help you to maintain your ZyWALL. These tools include updates on system status, port status and log and trace capabilities.

Select menu 24 in the main menu to open **Menu 24 - System Maintenance**, as shown below.

```
Menu 24 - System Maintenance

1. System Status
2. System Information and Console Port Speed
3. Log and Trace
4. Diagnostic
5. Backup Configuration
6. Restore Configuration
7. Upload Firmware
8. Command Interpreter Mode
9. Call Control
10. Time and Date Setting
11. Remote Management Setup

Enter Menu Selection Number:
```

Figure 34-1 Menu 24: System Maintenance

34.2 System Status

The first selection, System Status, gives you information on the version of your system firmware and the status and statistics of the ports, as shown in the next figure. System Status is a tool that can be used to monitor your ZyWALL. Specifically, it gives you information on your system firmware version, number of packets sent and number of packets received.

To get to the System Status:

- Step 1.** Enter number 24 to go to **Menu 24 - System Maintenance**.
- Step 2.** In this menu, enter 1 to open System Maintenance - Status.
- Step 3.** There are three commands in **Menu 24.1 - System Maintenance - Status**. Entering 1 drops the WAN connection, 9 resets the counters and [ESC] takes you back to the previous screen.

```

Menu 24.1 - System Maintenance - Status                                03:06:17
                                                                    Sat. Jan. 01, 2000

Port  Status      TxPkts    RxPkts    Cols    Tx B/s    Rx B/s    Up Time
WAN   Down          0          0         0        0         0         0:00:00
LAN   Down         463        792        0         0         0         0:00:00
DMZ   Down          0          0         0         0         0         0:00:00
WLAN  Down          0          0         0         0         0         0:00:00

Port  Ethernet Address      IP Address      IP Mask      DHCP
WAN   00:a0:c5:01:23:46      0.0.0.0        0.0.0.0      Client
LAN   00:a0:c5:01:23:45      192.168.1.1    255.255.255.0 Server
DMZ   00:a0:c5:01:23:47      0.0.0.0        0.0.0.0      None
WLAN  00:00:00:00:00:00

System up Time:      3:06:20

Press Command:

COMMANDS: 1-Drop WAN 9-Reset Counters  ESC-Exit
    
```

Figure 34-2 Menu 24.1: System Maintenance: Status (ZyWALL 100)

The following table describes the fields present in **Menu 24.1 - System Maintenance - Status**. These fields are READ-ONLY and meant for diagnostic purposes. The upper right corner of the screen shows the time and date according to the format you set in menu 24.10.

Table 34-1 System Maintenance: Status Menu Fields

FIELD	DESCRIPTION
Port	Identifies a port (WAN, LAN, DMZ or WLAN) on the ZyWALL. DMZ not available on all models.
Status	Shows the port speed and duplex setting if you're using Ethernet Encapsulation and Down (line is down), idle (line (ppp) idle), dial (starting to trigger a call) and drop (dropping a call) if you're using PPPoE Encapsulation .
TxPkts	The number of transmitted packets on this port.

Table 34-1 System Maintenance: Status Menu Fields

FIELD	DESCRIPTION
RxPkts	The number of received packets on this port.
Cols	The number of collisions on this port.
Tx B/s	Shows the transmission speed in Bytes per second on this port.
Rx B/s	Shows the reception speed in Bytes per second on this port.
Up Time	Total amount of time the line has been up.
Ethernet Address	The Ethernet address of the port listed on the left.
IP Address	The IP address of the port listed on the left.
IP Mask	The IP mask of the port listed on the left.
DHCP	The DHCP setting of the port listed on the left.
System up Time	The total time the ZyWALL has been on.
ZyNOS F/W Version	The ZyNOS Firmware version and the date created.
Some ZyWALL models include some or all of the following fields.	
Name	This is the ZyWALL's system name + domain name assigned in menu 1. For example, System Name= xxx; Domain Name= baboo.mickey.com Name= xxx.baboo.mickey.com
Routing	Refers to the routing protocol used.
ZyNOS F/W Version	The ZyNOS Firmware version and the date created.
You may enter 1 to drop the WAN connection, 9 to reset the counters or [ESC] to return to menu 24.	

34.3 System Information and Console Port Speed

This section describes your system and allows you to choose different console port speeds. To get to the System Information and Console Port Speed:

Step 1. Enter 24 to go to **Menu 24 – System Maintenance**.

Step 2. Enter 2 to open **Menu 24.2 - System Information and Console Port Speed**.

Step 3. From this menu you have two choices as shown in the next figure:

```

Menu 24.2 - System Information and Console Port Speed

1. System Information
2. Console Port Speed

Please enter selection:
    
```

Figure 34-3 Menu 24.2: System Information and Console Port Speed

34.3.1 System Information

System Information gives you information about your system as shown below. More specifically, it gives you information on your routing protocol, Ethernet address, IP address, etc.

```

Menu 24.2.1 - System Maintenance - Information

Name:
Routing: IP
ZyNOS F/W Version: V3.62(WH.0)b8 | 11/10/2003
Country Code: 255

LAN
Ethernet Address: 00:A0:C5:00:00:01
IP Address: 192.168.1.1
IP Mask: 255.255.255.0
DHCP: Server

Press ESC or RETURN to Exit:
    
```

Figure 34-4 Menu 24.2.1: System Maintenance: Information (ZyWALL 10W)

Table 34-2 Fields in System Maintenance: Information

FIELD	DESCRIPTION
Name	This is the ZyWALL's system name + domain name assigned in menu 1. For example, System Name= xxx; Domain Name= baboo.mickey.com Name= xxx.baboo.mickey.com

Table 34-2 Fields in System Maintenance: Information

Routing	Refers to the routing protocol used.
ZyNOS F/W Version	Refers to the version of ZyXEL's Network Operating System software.
Ethernet Address	Refers to the Ethernet MAC (Media Access Control) address of your ZyWALL.
IP Address	This is the IP address of the ZyWALL in dotted decimal notation.
IP Mask	This shows the IP mask of the ZyWALL.
DHCP	This field shows the DHCP setting of the ZyWALL.
When finished viewing, press [ESC] or [ENTER] to exit.	

34.3.2 Console Port Speed

You can change the speed of the console port through **Menu 24.2.2 – Console Port Speed**. Your ZyWALL supports 9600 (default), 19200, 38400, 57600, and 115200 bps for the console port. Press [SPACE BAR] and then [ENTER] to select the desired speed in menu 24.2.2, as shown next.

```

Menu 24.2.2 - System Maintenance - Change Console Port Speed

      Console Port Speed: 115200

      Press ENTER to Confirm or ESC to Cancel:
      Press Space Bar to Toggle.

```

Figure 34-5 Menu 24.2.2: System Maintenance: Change Console Port Speed

34.4 Log and Trace

There are two logging facilities in the ZyWALL. The first is the error logs and trace records that are stored locally. The second is the syslog facility for message logging.

34.4.1 Viewing Error Log

The first place you should look for clues when something goes wrong is the error/trace log. Follow the procedure below to view the local error/trace log:

- Step 1.** Select option 24 from the main menu to open **Menu 24 - System Maintenance**.
- Step 2.** From menu 24, select option 3 to open **Menu 24.3 - System Maintenance - Log and Trace**.
- Step 3.** Select the first option from **Menu 24.3 - System Maintenance - Log and Trace** to display the error log in the system.

After the ZyWALL finishes displaying, you will have the option to clear the error log.

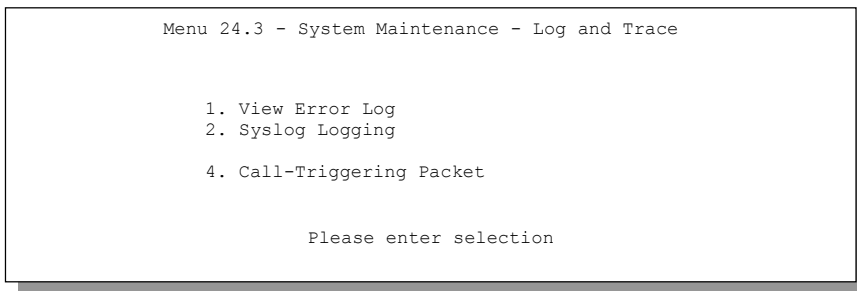

Figure 34-6 Menu 24.3: System Maintenance: Log and Trace

Examples of typical error and information messages are presented in the following figure.

```
0 Wed Aug 22 21:23:26 2001 PP17 INFO getDateime fail: no server available
1 Wed Aug 22 21:23:26 2001 PP17 INFO adjtime task pause 60 seconds
2 Wed Aug 22 21:23:54 2001 PINI INFO SMT Session Begin
3 Wed Aug 22 21:24:26 2001 PP0d INFO No DNS server available
4 Wed Aug 22 21:24:26 2001 PP17 WARN Wrong domain name
5 Wed Aug 22 21:24:26 2001 PP0d INFO No DNS server available
6 Wed Aug 22 21:24:26 2001 PP17 INFO Last errorlog repeat 8 Times
7 Wed Aug 22 21:24:26 2001 PP17 INFO getDateime fail: no server available
8 Wed Aug 22 21:24:26 2001 PP17 INFO adjtime task pause 1 day
10 Thu Aug 23 08:26:59 2001 PINI -WARN SNMP TRAP 0: cold start
11 Thu Aug 23 08:26:59 2001 PINI INFO main: init completed
12 Thu Aug 23 08:27:04 2001 PP17 INFO adjtime task pause 1 day
13 Thu Aug 23 08:27:28 2001 PINI INFO SMT Session Begin
14 Thu Aug 23 08:27:40 2001 PINI WARN system name is not configured
15 Thu Aug 23 08:27:41 2001 PP0d INFO LAN promiscuous mode <0>
16 Thu Aug 23 08:32:40 2001 PINI INFO SMT Session End
17 Thu Aug 23 08:33:07 2001 PINI INFO SMT Session Begin
18 Thu Aug 23 09:01:12 2001 PINI INFO SMT Session End
19 Thu Aug 23 09:02:09 2001 PINI INFO SMT Session Begin
Clear Error Log (y/n):
```

Figure 34-7 Examples of Error and Information Messages

34.4.2 Syslog Logging

The ZyWALL uses the syslog facility to log the CDR (Call Detail Record) and system messages to a syslog server. Syslog and accounting can be configured in **Menu 24.3.2 - System Maintenance - Syslog Logging**, as shown next.

```
Menu 24.3.2 - System Maintenance - Syslog Logging
```

```
Syslog:
Active= No
Syslog Server IP Address= ?
Log Facility= Local 1
```

```
Press ENTER to Confirm or ESC to Cancel
```

Figure 34-8 Menu 24.3.2: System Maintenance: Syslog Logging

You need to configure the syslog parameters described in the following table to activate syslog then choose what you want to log.

Table 34-3 System Maintenance Menu Syslog Logging

PARAMETER	DESCRIPTION
Syslog:	
Active	Press [SPACE BAR] and then [ENTER] to turn syslog on or off.
Syslog Server IP Address	Enter the IP Address of the server that will log the CDR (Call Detail Record) and system messages i.e., the syslog server.
Log Facility	Press [SPACE BAR] and then [ENTER] to select a Local option. The log facility allows you to log the message to different files in the server. Please refer to the documentation of your syslog program for more details.
When finished configuring this screen, press [ENTER] to confirm or [ESC] to cancel.	

Your ZyWALL sends five types of syslog messages. Some examples (not all ZyWALL specific) of these syslog messages with their message formats are shown next:

1. CDR

CDR Message Format
<pre>SdcmdSyslogSend(SYSLOG_CDR, SYSLOG_INFO, String); String = board xx line xx channel xx, call xx, str board = the hardware board ID line = the WAN ID in a board Channel = channel ID within the WAN call = the call reference number which starts from 1 and increments by 1 for each new call str = C01 Outgoing Call dev xx ch xx (dev:device No. ch:channel No.) L02 Tunnel Connected(L2TP) C02 OutCall Connected xxxx (means connected speed) xxxxx (means Remote Call Number) L02 Call Terminated C02 Call Terminated Jul 19 11:19:27 192.168.102.2 ZyXEL: board 0 line 0 channel 0, call 1, C01 Outgoing Call dev=2 ch=0 40002 Jul 19 11:19:32 192.168.102.2 ZyXEL: board 0 line 0 channel 0, call 1, C02 OutCall Connected 64000 40002 Jul 19 11:20:06 192.168.102.2 ZyXEL: board 0 line 0 channel 0, call 1, C02 Call Terminated</pre>

2. Packet triggered

Packet triggered Message Format

```
SdcmSyslogSend( SYSLOG_PKTTRI, SYSLOG_NOTICE, String );
String = Packet trigger: Protocol=xx Data=xxxxxxxxxx...x
Protocol: (1:IP 2:IPX 3:IPXHC 4:BPDU 5:ATALK 6:IPNG)
Data: We will send forty-eight Hex characters to the server
Jul 19 11:28:39 192.168.102.2 ZyXEL: Packet Trigger: Protocol=1,
Data=4500003c100100001f010004c0a86614ca849a7b08004a5c020001006162636465666768696a6b6c6d6e6f707172
7374
Jul 19 11:28:56 192.168.102.2 ZyXEL: Packet Trigger: Protocol=1,
Data=4500002c1b0140001f06b50ec0a86614ca849a7b0427001700195b3e00000000600220008cd40000020405b4
Jul 19 11:29:06 192.168.102.2 ZyXEL: Packet Trigger: Protocol=1,
Data=45000028240140001f06ac12c0a86614ca849a7b0427001700195b451d1430135004000077600000
```

3. Filter log

Filter log Message Format

```
SdcmSyslogSend(SYSLOG_FILLOG, SYSLOG_NOTICE, String );
String = IP[Src=xx.xx.xx.xx Dst=xx.xx.xx.xx prot spo=xxxx dpo=xxxx] S04>R01mD

IP[...] is the packet header and S04>R01mD means filter set 4 (S) and rule 1 (R), match (m) drop
(D).

Src: Source Address
Dst: Destination Address
prot: Protocol ("TCP", "UDP", "ICMP")
spo: Source port
dpo: Destination port
Mar 03 10:39:43 202.132.155.97 ZyXEL:
GEN[fffffffffnordff0080] }S05>R01mF
Mar 03 10:41:29 202.132.155.97 ZyXEL:
GEN[00a0c5f502fnord010080] }S05>R01mF
Mar 03 10:41:34 202.132.155.97 ZyXEL:
IP[Src=192.168.2.33 Dst=202.132.155.93 ICMP]}S04>R01mF
Mar 03 11:59:20 202.132.155.97 ZyXEL:
GEN[00a0c5f502fnord010080] }S05>R01mF
Mar 03 12:00:52 202.132.155.97 ZyXEL:
GEN[fffffffffff0080] }S05>R01mF
Mar 03 12:00:57 202.132.155.97 ZyXEL:
GEN[00a0c5f502010080] }S05>R01mF
Mar 03 12:01:06 202.132.155.97 ZyXEL:
IP[Src=192.168.2.33 Dst=202.132.155.93 TCP spo=01170 dpo=00021]}S04>R01mF
```

4. PPP log

PPP Log Message Format

```
SdcmSyslogSend( SYSLOG_PPPLLOG, SYSLOG_NOTICE, String );
String = ppp:Proto Starting / ppp:Proto Opening / ppp:Proto Closing / ppp:Proto Shutdown
Proto = LCP / ATCP / BACP / BCP / CBCP / CCP / CHAP/ PAP / IPCP /
IPXCP
Jul 19 11:42:44 192.168.102.2 ZyXEL: ppp:LCP Closing
Jul 19 11:42:49 192.168.102.2 ZyXEL: ppp:IPCP Closing
Jul 19 11:42:54 192.168.102.2 ZyXEL: ppp:CCP Closing
```

5. Firewall log

Firewall Log Message Format						
SdcmdSyslogSend(SYSLOG_FIREWALL, SYSLOG_NOTICE, buf);						
buf = IP[Src=xx.xx.xx.xx : spo=xxxx Dst=xx.xx.xx.xx : dpo=xxxx prot rule action]						
Src: Source Address						
spo: Source port (empty means no source port information)						
Dst: Destination Address						
dpo: Destination port (empty means no destination port information)						
prot: Protocol ("TCP", "UDP", "ICMP", "IGMP", "GRE", "ESP")						
rule: <a,b> where a means "set" number; b means "rule" number.						
Action: nothing(N) block (B) forward (F)						
08-01-2000	11:48:41	Local1.Notice	192.168.10.10	RAS: FW 172.21.1.80	:137	-
>172.21.1.80	:137	UDP default permit:<2,0> B				
08-01-2000	11:48:41	Local1.Notice	192.168.10.10	RAS: FW 192.168.77.88	:520	-
>192.168.77.88	:520	UDP default permit:<2,0> B				
08-01-2000	11:48:39	Local1.Notice	192.168.10.10	RAS: FW 172.21.1.50	->172.21.1.50	
IGMP<2> default	permit:<2,0> B					
08-01-2000	11:48:39	Local1.Notice	192.168.10.10	RAS: FW 172.21.1.25	->172.21.1.25	
IGMP<2> default	permit:<2,0> B					

34.4.3 Call-Triggering Packet

Call-Triggering Packet displays information about the packet that triggered a dial-out call in an easy readable format. Equivalent information is available in menu 24.1 in hex format. An example is shown next.

```

IP Frame: ENET0-RECV Size: 44/ 44   Time: 17:02:44.262
Frame Type:

  IP Header:
    IP Version           = 4
    Header Length        = 20
    Type of Service      = 0x00 (0)
    Total Length         = 0x002C (44)
    Identification      = 0x0002 (2)
    Flags                = 0x00
    Fragment Offset      = 0x00
    Time to Live         = 0xFE (254)
    Protocol             = 0x06 (TCP)
    Header Checksum      = 0xFB20 (64288)
    Source IP            = 0xC0A80101 (192.168.1.1)
    Destination IP      = 0x00000000 (0.0.0.0)

  TCP Header:
    Source Port          = 0x0401 (1025)
    Destination Port     = 0x000D (13)
    Sequence Number      = 0x05B8D000 (95997952)
    Ack Number           = 0x00000000 (0)
    Header Length        = 24
    Flags                = 0x02 (...S.)
    Window Size          = 0x2000 (8192)
    Checksum             = 0xE06A (57450)
    Urgent Ptr           = 0x0000 (0)
    Options              =
      0000: 02 04 02 00

  RAW DATA:
    0000: 45 00 00 2C 00 02 00 00-FE 06 FB 20 C0 A8 01 01  E.....
    0010: 00 00 00 00 04 01 00 0D-05 B8 D0 00 00 00 00 00  .....
    0020: 60 02 20 00 E0 6A 00 00-02 04 02 00

Press any key to continue...

```

Figure 34-9 Call-Triggering Packet Example

34.5 Diagnostic

The diagnostic facility allows you to test the different aspects of your ZyWALL to determine if it is working properly. Menu 24.4 allows you to choose among various types of diagnostic tests to evaluate your system, as shown next.

Follow the procedure below to get to **Menu 24.4 - System Maintenance – Diagnostic**.

Step 1. From the main menu, select option 24 to open **Menu 24 - System Maintenance**.

Step 2. From this menu, select option 4. Diagnostic. This will open **Menu 24.4 - System Maintenance - Diagnostic**.

```
Menu 24.4 - System Maintenance - Diagnostic

TCP/IP
 1. Ping Host
 2. WAN DHCP Release
 3. WAN DHCP Renewal
 4. Internet Setup Test

System
 11. Reboot System

Enter Menu Selection Number:

Host IP Address= N/A
```

Figure 34-10 Menu 24.4: System Maintenance: Diagnostic

34.5.1 WAN DHCP

DHCP functionality can be enabled on the LAN or WAN as shown in *Figure 34-11*. LAN DHCP has already been discussed. The ZyWALL can act either as a WAN DHCP client (**IP Address Assignment** field in menu 4 or menu 11.3 is **Dynamic** and the **Encapsulation** field in menu 4 or menu 11 is **Ethernet**) or **None**, (when you have a static IP). The **WAN Release** and **Renewal** fields in menu 24.4 conveniently allow you to release and/or renew the assigned WAN IP address, subnet mask and default gateway in a fashion similar to winipcfg.

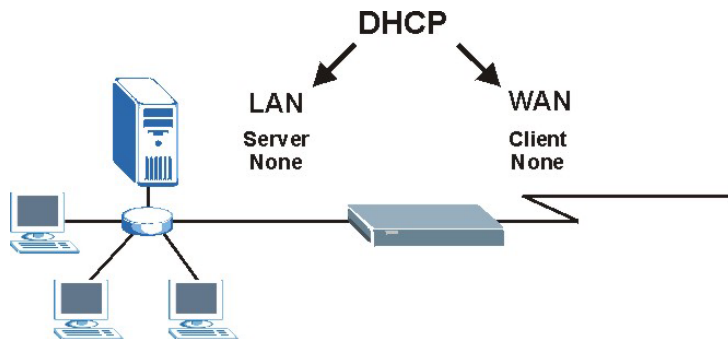

Figure 34-11 LAN & WAN DHCP

The following table describes the diagnostic tests available in menu 24.4 for your ZyWALL and associated connections.

Table 34-4 System Maintenance Menu Diagnostic

FIELD	DESCRIPTION
Ping Host	Enter 1 to ping any machine (with an IP address) on your LAN or WAN. Enter its IP address in the Host IP Address field below.
WAN DHCP Release	Enter 2 to release your WAN DHCP settings.
WAN DHCP Renewal	Enter 3 to renew your WAN DHCP settings.
Internet Setup Test	Enter 4 to test the Internet setup. You can also test the Internet setup in Menu 4 - Internet Access . Please refer to the <i>Internet Access</i> chapter for more details. This feature is only available for dial-up connections using PPPoE or PPTP encapsulation.
Reboot System	Enter 11 to reboot the ZyWALL.
Host IP Address=	If you entered 1 in Ping Host , then enter the IP address of the computer you want to ping in this field.
Enter the number of the selection you would like to perform or press [ESC] to cancel.	

Chapter 35

Firmware and Configuration File Maintenance

This chapter tells you how to back up and restore your configuration file as well as upload new firmware and a new configuration file.

35.1 Introduction

Use the instructions in this chapter to change the ZyWALL's configuration file or upgrade its firmware. After you configure your ZyWALL, you can backup the configuration file to a computer. That way if you later misconfigure the ZyWALL, you can upload the backed up configuration file to return to your previous settings. You can alternately upload the factory default configuration file if you want to return the ZyWALL to the original default settings. The firmware determines the ZyWALL's available features and functionality. You can download new firmware releases from your nearest ZyXEL FTP site to use to upgrade your ZyWALL's performance.

35.2 Filename Conventions

The configuration file (often called the romfile or rom-0) contains the factory default settings in the menus such as password, DHCP Setup, TCP/IP Setup, etc. It arrives from ZyXEL with a "rom" filename extension. Once you have customized the ZyWALL's settings, they can be saved back to your computer under a filename of your choosing.

ZyNOS (ZyXEL Network Operating System sometimes referred to as the "ras" file) is the system firmware and has a "bin" filename extension. With many FTP and TFTP clients, the filenames are similar to those seen next.

```
ftp> put firmware.bin ras
```

This is a sample FTP session showing the transfer of the computer file " firmware.bin" to the ZyWALL.

```
ftp> get rom-0 config.cfg
```

This is a sample FTP session saving the current configuration to the computer file "config.cfg".

If your (T)FTP client does not allow you to have a destination filename different than the source, you will need to rename them as the ZyWALL only recognizes "rom-0" and "ras". Be sure you keep unaltered copies of both files for later use.

The following table is a summary. Please note that the internal filename refers to the filename on the ZyWALL and the external filename refers to the filename not on the ZyWALL, that is, on your computer, local network or FTP site and so the name (but not the extension) may vary. After uploading new firmware, see the **ZyNOS F/W Version** field in **Menu 24.2.1 - System Maintenance - Information** to confirm that you have uploaded the correct firmware version. The AT command is the command you enter after you press "y" when prompted in the SMT menu to go into debug mode.

Table 35-1 Filename Conventions

FILE TYPE	INTERNAL NAME	EXTERNAL NAME	DESCRIPTION
Configuration File	Rom-0	This is the configuration filename on the ZyWALL. Uploading the rom-0 file replaces the entire ROM file system, including your ZyWALL configurations, system-related data (including the default password), the error log and the trace log.	*.rom
Firmware	Ras	This is the generic name for the ZyNOS firmware on the ZyWALL.	*.bin

35.3 Backup Configuration

The ZyWALL displays different messages explaining different ways to backup, restore and upload files in menus 24.5, 24.6, 24. 7.1 and 24.7.2 depending on whether you use the console port or Telnet.

Option 5 from **Menu 24 - System Maintenance** allows you to backup the current ZyWALL configuration to your computer. Backup is highly recommended once your ZyWALL is functioning properly. FTP is the

preferred method for backing up your current configuration to your computer since it is faster. You can also perform backup and restore using menu 24 through the console port. Any serial communications program should work fine; however, you must use Xmodem protocol to perform the download/upload and you don't have to rename the files.

Please note that terms “download” and “upload” are relative to the computer. Download means to transfer from the ZyWALL to the computer, while upload means from your computer to the ZyWALL.

35.3.1 Backup Configuration

Follow the instructions as shown in the next screen.

```
Menu 24.5 - System Maintenance - Backup Configuration

To transfer the configuration file to your workstation, follow the procedure
below:

1. Launch the FTP client on your workstation.
2. Type "open" and the IP address of your router. Then type "root" and
   SMT password as requested.
3. Locate the 'rom-0' file.
4. Type 'get rom-0' to back up the current router configuration to
   your workstation.

For details on FTP commands, please consult the documentation of your FTP
client program. For details on backup using TFTP (note that you must remain
in this menu to back up using TFTP), please see your router manual.

Press ENTER to Exit:
```

Figure 35-1 Telnet into Menu 24.5

35.3.2 Using the FTP Command from the Command Line

- Step 1.** Launch the FTP client on your computer.
- Step 2.** Enter “open”, followed by a space and the IP address of your ZyWALL.
- Step 3.** Press [ENTER] when prompted for a username.
- Step 4.** Enter your password as requested (the default is “1234”).
- Step 5.** Enter “bin” to set transfer mode to binary.

Step 6. Use “get” to transfer files from the ZyWALL to the computer, for example, “get rom-0 config.rom” transfers the configuration file on the ZyWALL to your computer and renames it “config.rom”. See earlier in this chapter for more information on filename conventions.

Step 7. Enter “quit” to exit the ftp prompt.

35.3.3 Example of FTP Commands from the Command Line

```

331 Enter PASS command
Password:
230 Logged in
ftp> bin
200 Type I OK
ftp> get rom-0 zyxel.rom
200 Port command okay
150 Opening data connection for STOR ras
226 File received OK
ftp: 16384 bytes sent in 1.10Seconds 297.89Kbytes/sec.
ftp> quit
    
```

Figure 35-2 FTP Session Example

35.3.4 GUI-based FTP Clients

The following table describes some of the commands that you may see in GUI-based FTP clients.

Table 35-2 General Commands for GUI-based FTP Clients

COMMAND	DESCRIPTION
Host Address	Enter the address of the host server.
Login Type	Anonymous. This is when a user I.D. and password is automatically supplied to the server for anonymous access. Anonymous logins will work only if your ISP or service administrator has enabled this option. Normal. The server requires a unique User ID and Password to login.
Transfer Type	Transfer files in either ASCII (plain text format) or in binary mode. Configuration and firmware files should be transferred in binary mode.
Initial Remote Directory	Specify the default remote directory (path).

Table 35-2 General Commands for GUI-based FTP Clients

COMMAND	DESCRIPTION
Initial Local Directory	Specify the default local directory (path).

35.3.5 File Maintenance Over WAN Limitations

TFTP, FTP and Telnet over the WAN will not work when:

1. The firewall is active (turn the firewall off in menu 21.2 or create a firewall rule to allow access from the WAN).
2. You have disabled Telnet service in menu 24.11.
3. You have applied a filter in menu 3.1 (LAN) or in menu 11.5 (WAN) to block Telnet service.
4. The IP you entered in the **Secured Client IP** field in menu 24.11 does not match the client IP. If it does not match, the ZyWALL will disconnect the Telnet session immediately.
5. You have an SMT console session running.

35.3.6 Backup Configuration Using TFTP

The ZyWALL supports the up/downloading of the firmware and the configuration file using TFTP (Trivial File Transfer Protocol) over LAN. Although TFTP should work over WAN as well, it is not recommended.

To use TFTP, your computer must have both telnet and TFTP clients. To backup the configuration file, follow the procedure shown next.

- Step 1.** Use telnet from your computer to connect to the ZyWALL and log in. Because TFTP does not have any security checks, the ZyWALL records the IP address of the telnet client and accepts TFTP requests only from this address.
- Step 2.** Put the SMT in command interpreter (CI) mode by entering 8 in **Menu 24 – System Maintenance**.
- Step 3.** Enter command “sys stdio 0” to disable the SMT timeout, so the TFTP transfer will not be interrupted. Enter command “sys stdio 5” to restore the five-minute SMT timeout (default) when the file transfer is complete.
- Step 4.** Launch the TFTP client on your computer and connect to the ZyWALL. Set the transfer mode to binary before starting data transfer.

Step 5. Use the TFTP client (see the example below) to transfer files between the ZyWALL and the computer. The file name for the configuration file is “rom-0” (rom-zero, not capital o).

Note that the telnet connection must be active and the SMT in CI mode before and during the TFTP transfer. For details on TFTP commands (see following example), please consult the documentation of your TFTP client program. For UNIX, use “get” to transfer from the ZyWALL to the computer and “binary” to set binary transfer mode.

35.3.7 TFTP Command Example

The following is an example TFTP command:

```
tftp [-i] host get rom-0 config.rom
```

Where “i” specifies binary image transfer mode (use this mode when transferring binary files), “host” is the ZyWALL IP address, “get” transfers the file source on the ZyWALL (rom-0, name of the configuration file on the ZyWALL) to the file destination on the computer and renames it config.rom.

35.3.8 GUI-based TFTP Clients

The following table describes some of the fields that you may see in GUI-based TFTP clients.

Table 35-3 General Commands for GUI-based TFTP Clients

COMMAND	DESCRIPTION
Host	Enter the IP address of the ZyWALL. 192.168.1.1 is the ZyWALL’s default IP address when shipped.
Send/Fetch	Use “Send” to upload the file to the ZyWALL and “Fetch” to back up the file on your computer.
Local File	Enter the path and name of the firmware file (*.bin extension) or configuration file (*.rom extension) on your computer.
Remote File	This is the filename on the ZyWALL. The filename for the firmware is “ras” and for the configuration file, is “rom-0”.
Binary	Transfer the file in binary mode.
Abort	Stop transfer of the file.

Refer to *section 35.3.5* to read about configurations that disallow TFTP and FTP over WAN.

35.3.9 Backup Via Console Port

Back up configuration via console port by following the HyperTerminal procedure shown next. Procedures using other serial communications programs should be similar.

Step 1. Display menu 24.5 and enter “y” at the following screen.

```
Ready to backup Configuration via Xmodem.
Do you want to continue (y/n):
```

Figure 35-3 System Maintenance: Backup Configuration

Step 2. The following screen indicates that the Xmodem download has started.

```
You can enter ctrl-x to terminate operation any time.
Starting XMODEM download...
```

Figure 35-4 System Maintenance: Starting Xmodem Download Screen

Step 3. Run the HyperTerminal program by clicking **Transfer**, then **Receive File** as shown in the following screen.

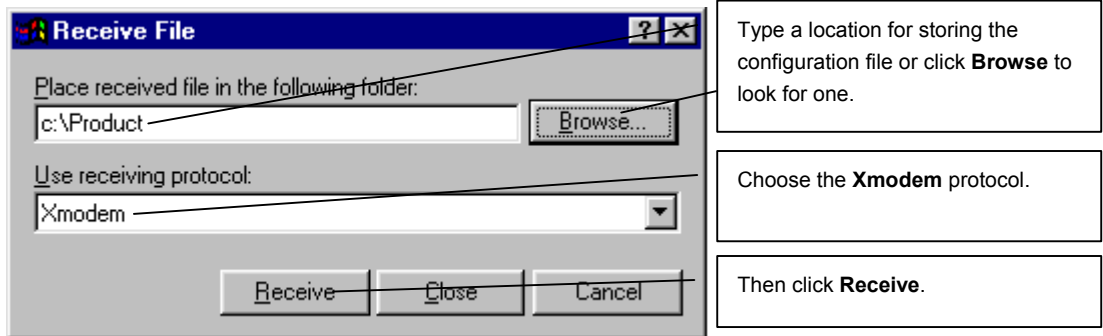

Figure 35-5 Backup Configuration Example

Step 4. After a successful backup you will see the following screen. Press any key to return to the SMT menu.

```
** Backup Configuration completed. OK.  
### Hit any key to continue.###
```

Figure 35-6 Successful Backup Confirmation Screen

35.4 Restore Configuration

This section shows you how to restore a previously saved configuration. Note that this function erases the current configuration before restoring a previous back up configuration; please do not attempt to restore unless you have a backup configuration file stored on disk.

FTP is the preferred method for restoring your current computer configuration to your ZyWALL since FTP is faster. Please note that you must wait for the system to automatically restart after the file transfer is complete.

WARNING!

Do not interrupt the file transfer process as this may PERMANENTLY DAMAGE YOUR ZyWALL. When the Restore Configuration process is complete, the ZyWALL will automatically restart.

35.4.1 Restore Using FTP

For details about backup using (T)FTP please refer to earlier sections on FTP and TFTP file upload in this chapter.

```
Menu 24.6 -- System Maintenance - Restore Configuration

To transfer the firmware and configuration file to your workstation, follow the procedure
below:

1. Launch the FTP client on your workstation.
2. Type "open" and the IP address of your router. Then type "root" and
   SMT password as requested.
3. Type "put backupfilename rom-0" where backupfilename is the name of
   your backup configuration file on your workstation and rom-0 is the
   remote file name on the router. This restores the configuration to
   your router.
4. The system reboots automatically after a successful file transfer

For details on FTP commands, please consult the documentation of your FTP
client program. For details on backup using TFTP (note that you must remain
in this menu to back up using TFTP), please see your router manual.

Press ENTER to Exit:
```

Figure 35-7 Telnet into Menu 24.6

- Step 1.** Launch the FTP client on your computer.
- Step 2.** Enter “open”, followed by a space and the IP address of your ZyWALL.
- Step 3.** Press [ENTER] when prompted for a username.
- Step 4.** Enter your password as requested (the default is “1234”).
- Step 5.** Enter “bin” to set transfer mode to binary.
- Step 6.** Find the “rom” file (on your computer) that you want to restore to your ZyWALL.
- Step 7.** Use “put” to transfer files from the ZyWALL to the computer, for example, “put config.rom rom-0” transfers the configuration file “config.rom” on your computer to the ZyWALL. See earlier in this chapter for more information on filename conventions.
- Step 8.** Enter “quit” to exit the ftp prompt. The ZyWALL will automatically restart after a successful restore process.

35.4.2 Restore Using FTP Session Example

```
ftp> put config.rom rom-0
200 Port command okay
150 Opening data connection for STOR rom-0
226 File received OK
221 Goodbye for writing flash
ftp: 16384 bytes sent in 0.06Seconds 273.07Kbytes/sec.
ftp>quit
```

Figure 35-8 Restore Using FTP Session Example

Refer to *section 35.3.5* to read about configurations that disallow TFTP and FTP over WAN.

35.4.3 Restore Via Console Port

Restore configuration via console port by following the HyperTerminal procedure shown next. Procedures using other serial communications programs should be similar.

Step 1. Display menu 24.6 and enter “y” at the following screen.

```
Ready to restore Configuration via Xmodem.
Do you want to continue (y/n):
```

Figure 35-9 System Maintenance: Restore Configuration

Step 2. The following screen indicates that the Xmodem download has started.

```
Starting XMODEM download (CRC mode) ...
CCCCCCCC
```

Figure 35-10 System Maintenance: Starting Xmodem Download Screen

Step 3. Run the HyperTerminal program by clicking **Transfer**, then **Send File** as shown in the following screen.

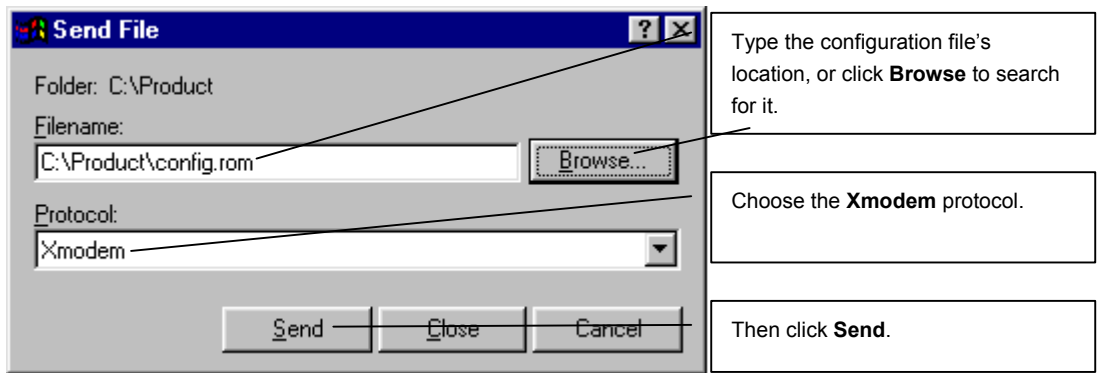

Figure 35-11 Restore Configuration Example

- Step 4.** After a successful restoration you will see the following screen. Press any key to restart the ZyWALL and return to the SMT menu.

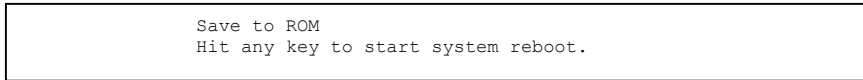

Figure 35-12 Successful Restoration Confirmation Screen

35.5 Uploading Firmware and Configuration Files

This section shows you how to upload firmware and configuration files. You can upload configuration files by following the procedure in the previous *Restore Configuration* section or by following the instructions in **Menu 24.7.2 - System Maintenance - Upload System Configuration File** (for console port).

WARNING!

Do not interrupt the file transfer process as this may PERMANENTLY DAMAGE YOUR ZyWALL.

35.5.1 Firmware File Upload

FTP is the preferred method for uploading the firmware and configuration. To use this feature, your computer must have an FTP client.

When you telnet into the ZyWALL, you will see the following screens for uploading firmware and the configuration file using FTP.

```
Menu 24.7.1 - System Maintenance - Upload System Firmware

To upload the system firmware, follow the procedure below:

1. Launch the FTP client on your workstation.
2. Type "open" and the IP address of your system. Then type "root" and
   SMT password as requested.
3. Type "put firmwarefilename ras" where "firmwarefilename" is the name
   of your firmware upgrade file on your workstation and "ras" is the
   remote file name on the system.
4. The system reboots automatically after a successful firmware upload.

For details on FTP commands, please consult the documentation of your FTP
client program. For details on uploading system firmware using TFTP (note
that you must remain on this menu to upload system firmware using TFTP),
please see your manual.

Press ENTER to Exit:
```

Figure 35-13 Telnet Into Menu 24.7.1: Upload System Firmware

35.5.2 Configuration File Upload

You see the following screen when you telnet into menu 24.7.2.

```
Menu 24.7.2 - System Maintenance - Upload System Configuration File

To upload the system configuration file, follow the procedure below:

1. Launch the FTP client on your workstation.
2. Type "open" and the IP address of your system. Then type "root" and
   SMT password as requested.
3. Type "put configurationfilename rom-0" where "configurationfilename"
   is the name of your system configuration file on your workstation, which
   will be transferred to the "rom-0" file on the system.
4. The system reboots automatically after the upload system configuration
   file process is complete.

For details on FTP commands, please consult the documentation of your FTP
client program. For details on uploading configuration file using TFTP (note
that you must remain on this menu to upload configuration file using TFTP),
please see your manual.

Press ENTER to Exit:
```

Figure 35-14 Telnet Into Menu 24.7.2: System Maintenance

To upload the firmware and the configuration file, follow these examples

35.5.3 FTP File Upload Command from the DOS Prompt Example

- Step 1.** Launch the FTP client on your computer.
- Step 2.** Enter "open", followed by a space and the IP address of your ZyWALL.
- Step 3.** Press [ENTER] when prompted for a username.
- Step 4.** Enter your password as requested (the default is "1234").
- Step 5.** Enter "bin" to set transfer mode to binary.
- Step 6.** Use "put" to transfer files from the computer to the ZyWALL, for example, "put firmware.bin ras" transfers the firmware on your computer (firmware.bin) to the ZyWALL and renames it "ras". Similarly, "put config.rom rom-0" transfers the configuration file on your computer (config.rom) to the ZyWALL and renames it "rom-0". Likewise "get rom-0 config.rom"

transfers the configuration file on the ZyWALL to your computer and renames it “config.rom.” See earlier in this chapter for more information on filename conventions.

Step 7. Enter “quit” to exit the ftp prompt.

35.5.4 FTP Session Example of Firmware File Upload

```
331 Enter PASS command
Password:
230 Logged in
ftp> bin
200 Type I OK
ftp> put firmware.bin ras
200 Port command okay
150 Opening data connection for STOR ras
226 File received OK
ftp: 1103936 bytes sent in 1.10Seconds 297.89Kbytes/sec.
ftp> quit
```

Figure 35-15 FTP Session Example of Firmware File Upload

More commands (found in GUI-based FTP clients) are listed earlier in this chapter.

Refer to *section 35.3.5* to read about configurations that disallow TFTP and FTP over WAN.

35.5.5 TFTP File Upload

The ZyWALL also supports the uploading of firmware files using TFTP (Trivial File Transfer Protocol) over LAN. Although TFTP should work over WAN as well, it is not recommended.

To use TFTP, your computer must have both telnet and TFTP clients. To transfer the firmware and the configuration file, follow the procedure shown next.

- Step 1.** Use telnet from your computer to connect to the ZyWALL and log in. Because TFTP does not have any security checks, the ZyWALL records the IP address of the telnet client and accepts TFTP requests only from this address.
- Step 2.** Put the SMT in command interpreter (CI) mode by entering 8 in **Menu 24 – System Maintenance**.

- Step 3.** Enter the command “sys stdio 0” to disable the console timeout, so the TFTP transfer will not be interrupted. Enter “command sys stdio 5” to restore the five-minute console timeout (default) when the file transfer is complete.
- Step 4.** Launch the TFTP client on your computer and connect to the ZyWALL. Set the transfer mode to binary before starting data transfer.
- Step 5.** Use the TFTP client (see the example below) to transfer files between the ZyWALL and the computer. The file name for the firmware is “ras”.

Note that the telnet connection must be active and the ZyWALL in CI mode before and during the TFTP transfer. For details on TFTP commands (see following example), please consult the documentation of your TFTP client program. For UNIX, use “get” to transfer from the ZyWALL to the computer, “put” the other way around, and “binary” to set binary transfer mode.

35.5.6 TFTP Upload Command Example

The following is an example TFTP command:

```
tftp [-i] host put firmware.bin ras
```

Where “i” specifies binary image transfer mode (use this mode when transferring binary files), “host” is the ZyWALL’s IP address, “put” transfers the file source on the computer (firmware.bin – name of the firmware on the computer) to the file destination on the remote host (ras - name of the firmware on the ZyWALL).

Commands that you may see in GUI-based TFTP clients are listed earlier in this chapter.

35.5.7 Uploading Via Console Port

FTP or TFTP are the preferred methods for uploading firmware to your ZyWALL. However, in the event of your network being down, uploading files is only possible with a direct connection to your ZyWALL via the console port. Uploading files via the console port under normal conditions is not recommended since FTP or TFTP is faster. Any serial communications program should work fine; however, you must use the Xmodem protocol to perform the download/upload.

35.5.8 Uploading Firmware File Via Console Port

- Step 1.** Select 1 from **Menu 24.7 – System Maintenance – Upload Firmware** to display **Menu 24.7.1 – System Maintenance - Upload System Firmware**, and then follow the instructions as shown in the following screen.

```
Menu 24.7.1 - System Maintenance - Upload System Firmware

To upload system firmware:
1. Enter "y" at the prompt below to go into debug mode.
2. Enter "atur" after "Enter Debug Mode" message.
3. Wait for "Starting XMODEM upload" message before activating
   Xmodem upload on your terminal.
4. After successful firmware upload, enter "atgo" to restart the
   router.

Warning: Proceeding with the upload will erase the current system
firmware.

          Do You Wish To Proceed:(Y/N)
```

Figure 35-16 Menu 24.7.1 As Seen Using the Console Port

- Step 2.** After the "Starting Xmodem upload" message appears, activate the Xmodem protocol on your computer. Follow the procedure as shown previously for the HyperTerminal program. The procedure for other serial communications programs should be similar.

35.5.9 Example Xmodem Firmware Upload Using HyperTerminal

Click **Transfer**, then **Send File** to display the following screen.

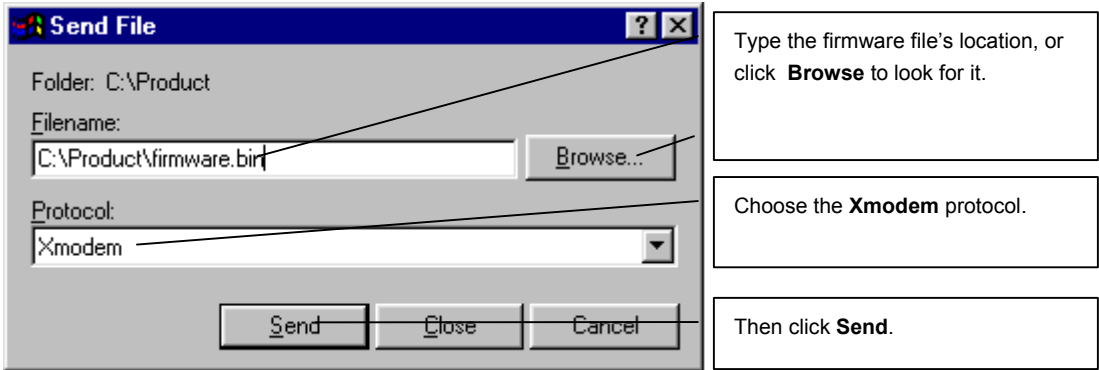

Figure 35-17 Example Xmodem Upload

After the firmware upload process has completed, the ZyWALL will automatically restart.

35.5.10 Uploading Configuration File Via Console Port

Step 1. Select 2 from **Menu 24.7 – System Maintenance – Upload Firmware** to display **Menu 24.7.2 – System Maintenance - Upload System Configuration File**. Follow the instructions as shown in the next screen.

```
Menu 24.7.2 - System Maintenance - Upload System Configuration File

To upload system configuration file:
1. Enter "y" at the prompt below to go into debug mode.
2. Enter "atlc" after "Enter Debug Mode" message.
3. Wait for "Starting XMODEM upload" message before activating
   Xmodem upload on your terminal.
4. After successful firmware upload, enter "atgo" to restart the
   system.

Warning:
1. Proceeding with the upload will erase the current
   configuration file.
2. The system's console port speed (Menu 24.2.2) may change
   when it is restarted; please adjust your terminal's speed
   accordingly. The password may change (menu 23), also.
3. When uploading the DEFAULT configuration file, the console
   port speed will be reset to 9600 bps and the password to
   "1234".

Do You Wish To Proceed: (Y/N)
```

Figure 35-18 Menu 24.7.2 As Seen Using the Console Port

Step 2. After the "Starting Xmodem upload" message appears, activate the Xmodem protocol on your computer. Follow the procedure as shown previously for the HyperTerminal program. The procedure for other serial communications programs should be similar.

Step 3. Enter "atgo" to restart the ZyWALL.

35.5.11 Example Xmodem Configuration Upload Using HyperTerminal

Click **Transfer**, then **Send File** to display the following screen.

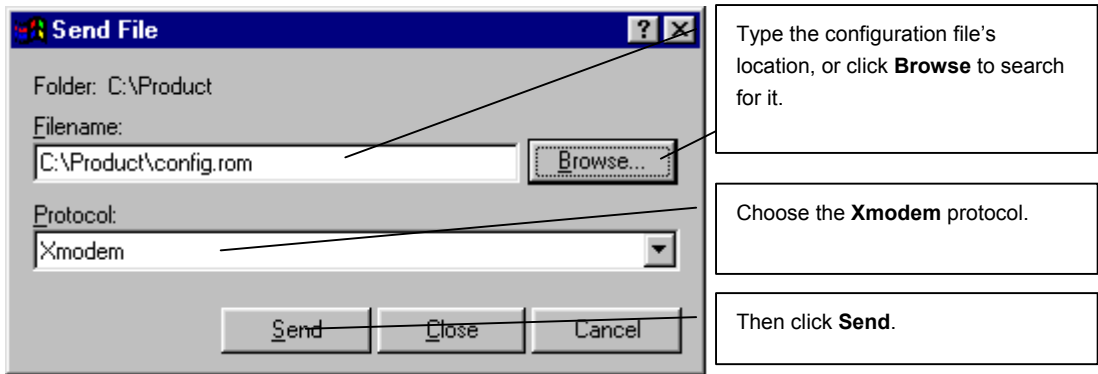

Figure 35-19 Example Xmodem Upload

After the configuration upload process has completed, restart the ZyWALL by entering "atgo".

Chapter 36

System Maintenance Menus 8 to 10

This chapter leads you through SMT menus 24.8 to 24.10.

36.1 Command Interpreter Mode

The Command Interpreter (CI) is a part of the main router firmware. The CI provides much of the same functionality as the SMT, while adding some low-level setup and diagnostic functions. Enter the CI from the SMT by selecting menu 24.8. Access can be by Telnet or by a serial connection to the console port, although some commands are only available with a serial connection. See the included disk or zyxel.com for more detailed information on CI commands. Enter 8 from **Menu 24 - System Maintenance**.

Use of undocumented commands or misconfiguration can damage the unit and possibly render it unusable.

```
Menu 24 - System Maintenance

1. System Status
2. System Information and Console Port Speed
3. Log and Trace
4. Diagnostic
5. Backup Configuration
6. Restore Configuration
7. Firmware Update
8. Command Interpreter Mode
9. Call Control
10. Time and Date Setting
11. Remote Management Setup

Enter Menu Selection Number:
```

Figure 36-1 Command Mode in Menu 24

36.1.1 Command Syntax

The command keywords are in `courier` new font.

Enter the command keywords exactly as shown, do not abbreviate.

The required fields in a command are enclosed in angle brackets `<>`.

The optional fields in a command are enclosed in square brackets `[]`.

The `|` symbol means “or”.

For example,

```
sys filter netbios config <type> <on|off>
```

means that you must specify the type of netbios filter and whether to turn it on or off.

36.1.2 Command Usage

A list of commands can be found by typing `help` or `?` at the command prompt. Always type the full command. Type `exit` to return to the SMT main menu when finished.

```
Copyright (c) 1994 - 2003 ZyXEL Communications Corp.
ras> ?
Valid commands are:
sys          exit          ether          ip
ipsec       bridge        bm            certificates
8021x       radius
```

Figure 36-2 Valid Commands

Table 36-1 Valid Commands

COMMAND	DESCRIPTION
sys	The system commands display device information and configure device settings.
exit	This command returns you to the SMT main menu.
ether	These commands display Ethernet information and configure Ethernet settings.
ip	These commands display IP information and configure IP settings.
ipsec	These commands display IPSec information and configure IPSec settings.

Table 36-1 Valid Commands

COMMAND	DESCRIPTION
bridge	These commands display bridge information.
bm	These commands configure bandwidth management settings and display bandwidth management information.
certificates	These commands display certificate information and configure certificate settings.
8021x	These commands configure 802.1x settings and display 802.1x information.
radius	These commands display RADIUS information and configure RADIUS settings.

36.2 Call Control Support

The ZyWALL provides two call control functions: budget management and call history. Please note that this menu is only applicable when **Encapsulation** is set to **PPPoE** or **PPTP** in menu 4 or menu 11.1.

The budget management function allows you to set a limit on the total outgoing call time of the ZyWALL within certain times. When the total outgoing call time exceeds the limit, the current call will be dropped and any future outgoing calls will be blocked.

Call history chronicles preceding incoming and outgoing calls.

To access the call control menu, select option 9 in menu 24 to go to **Menu 24.9 - System Maintenance - Call Control**, as shown in the next table.

```

Menu 24.9 - System Maintenance - Call Control

1.Budget Management
2.Call History

Enter Menu Selection Number:

```

Figure 36-3 Call Control

36.2.1 Budget Management

Menu 24.9.1 shows the budget management statistics for outgoing calls. Enter 1 from **Menu 24.9 - System Maintenance - Call Control** to bring up the following menu.

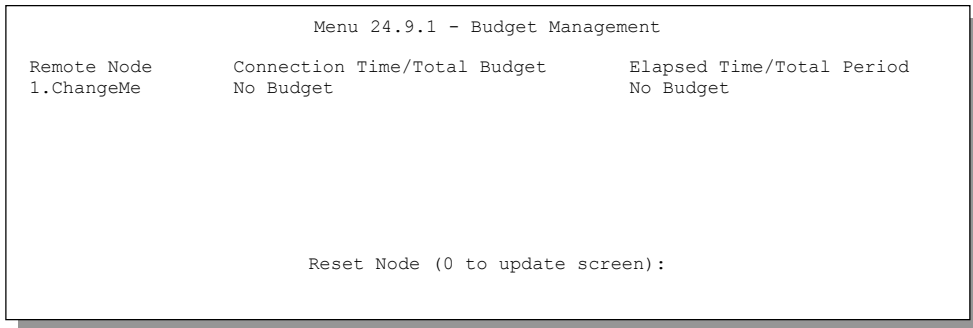

Figure 36-4 Budget Management

The total budget is the time limit on the accumulated time for outgoing calls to a remote node. When this limit is reached, the call will be dropped and further outgoing calls to that remote node will be blocked. After each period, the total budget is reset. The default for the total budget is 0 minutes and the period is 0 hours, meaning no budget control. You can reset the accumulated connection time in this menu by entering the index of a remote node. Enter 0 to update the screen. The budget and the reset period can be configured in menu 11.1 for the remote node.

Table 36-2 Budget Management

FIELD	DESCRIPTION	EXAMPLE
Remote Node	Enter the index number of the remote node you want to reset (just one in this case)	1
Connection Time/Total Budget	This is the total connection time that has gone by (within the allocated budget that you set in menu 11.1).	5/10 means that 5 minutes out of a total allocation of 10 minutes have lapsed.
Elapsed Time/Total Period	The period is the time cycle in hours that the allocation budget is reset (see menu 11.1.) The elapsed time is the time used up within this period.	0.5/1 means that 30 minutes out of the 1-hour time period has lapsed.
Enter "0" to update the screen or press [ESC] to return to the previous screen.		

36.2.2 Call History

This is the second option in **Menu 24.9 - System Maintenance - Call Control**. It displays information about past incoming and outgoing calls. Enter 2 from **Menu 24.9 - System Maintenance - Call Control** to bring up the following menu.

```

Menu 24.9.2 - Call History

Phone Number   Dir   Rate   #call   Max   Min   Total

1.
2.
3.
4.
5.
6.
7.
8.
9.
10.

Enter Entry to Delete(0 to exit):

```

Figure 36-5 Call History

The following table describes the fields in this screen.

Table 36-3 Call History Fields

FIELD	DESCRIPTION
Phone Number	The PPPoE service names are shown here.
Dir	This shows whether the call was incoming or outgoing.
Rate	This is the transfer rate of the call.
#call	This is the number of calls made to or received from that telephone number.
Max	This is the length of time of the longest telephone call.
Min	This is the length of time of the shortest telephone call.
Total	This is the total length of time of all the telephone calls to/from that telephone number.
You may enter an entry number to delete it or "0" to exit.	

36.3 Time and Date Setting

The Real Time Chip (RTC) keeps track of the time and date (not available on all models). There is also a software mechanism to set the time manually or get the current time and date from an external server when you turn on your ZyWALL. Menu 24.10 allows you to update the time and date settings of your ZyWALL. The real time is then displayed in the ZyWALL error logs and firewall logs.

Select menu 24 in the main menu to open **Menu 24 - System Maintenance**, as shown next.

```
Menu 24 - System Maintenance

1. System Status
2. System Information and Console Port Speed
3. Log and Trace
4. Diagnostic
5. Backup Configuration
6. Restore Configuration
7. Upload Firmware
8. Command Interpreter Mode
9. Call Control
10. Time and Date Setting
11. Remote Management Setup

Enter Menu Selection Number:
```

Figure 36-6 Menu 24: System Maintenance

Enter 10 to go to **Menu 24.10 - System Maintenance - Time and Date Setting** to update the time and date settings of your ZyWALL as shown in the following screen.

```

Menu 24.10 - System Maintenance - Time and Date Setting

Use Time Server when Bootup= NTP (RFC-1305)
Time Server Address= tick.stdtime.gov.tw

Current Time:                               00 : 00 : 00
New Time (hh:mm:ss):                       11 : 23 : 16

Current Date:                               2000 - 01 - 01
New Date (yyyy-mm-dd):                    2001 - 03 - 01

Time Zone= GMT+0800

Daylight Saving= No
Start Date (mm-dd):                        01 - 01
End Date (mm_dd):                          01 - 01

Press ENTER to Confirm or ESC to Cancel:

```

Figure 36-7 Menu 24.10 System Maintenance: Time and Date Setting

The following table describes the fields in this screen.

Table 36-4 Time and Date Setting Fields

FIELD	DESCRIPTION
Use Time Server when Bootup	Enter the time service protocol that your timeserver sends when you turn on the ZyWALL. Not all timeservers support all protocols, so you may have to check with your ISP/network administrator or use trial and error to find a protocol that works. The main differences between them are the format. Daytime (RFC 867) format is day/month/year/time zone of the server. Time (RFC-868) format displays a 4-byte integer giving the total number of seconds since 1970/1/1 at 0:0:0. NTP (RFC-1305) the default, is similar to Time (RFC-868) . None enter the time manually.
Time Server Address	Enter the IP address or domain name of your timeserver. Check with your ISP/network administrator if you are unsure of this information. The default is tick.stdtime.gov.tw
Current Time	This field displays an updated time only when you reenter this menu.
New Time	Enter the new time in hour, minute and second format.
Current Date	This field displays an updated date only when you reenter this menu.
New Date	Enter the new date in year, month and day format.

Table 36-4 Time and Date Setting Fields

FIELD	DESCRIPTION
Time Zone	Press [SPACE BAR] and then [ENTER] to set the time difference between your time zone and Greenwich Mean Time (GMT).
Daylight Saving	Daylight Saving Time is a period from late spring to early fall when many countries set their clocks ahead of normal local time by one hour to give more daylight time in the evenings. If you use daylight savings time, then choose Yes .
Start Date	Enter the month and day that your daylight-savings time starts on if you selected Yes in the Daylight Saving field.
End Date	Enter the month and day that your daylight-savings time ends on if you selected Yes in the Daylight Saving field.
Once you have filled in this menu, press [ENTER] at the message "Press ENTER to Confirm or ESC to Cancel" to save your configuration, or press [ESC] to cancel.	

36.3.1 Resetting the Time

The ZyWALL resets the time in three instances:

- i. On leaving menu 24.10 after making changes.
- ii. When the ZyWALL starts up, if there is a timeserver configured in menu 24.10.
- iii. 24-hour intervals after starting.

Chapter 37

Remote Management

This chapter covers remote management found in SMT menu 24.11.

37.1 Remote Management

Remote management allows you to determine which services/protocols can access which ZyWALL interface (if any) from which computers.

You may manage your ZyWALL from a remote location via:

- Internet (WAN only)
- LAN only
- DMZ only
- ALL (LAN and WAN)
- Neither (Disable).

When you Choose WAN only or ALL (LAN & DMZ & WAN), you still need to configure a firewall rule to allow access.

To disable remote management of a service, select **Disable** in the corresponding **Server Access** field.

Enter 11 from menu 24 to bring up **Menu 24.11 – Remote Management Control**.

```

Menu 24.11 - Remote Management Control

TELNET Server:      Port = 23          Access = ALL
                   Secured Client IP = 0.0.0.0

FTP Server:        Port = 21          Access = ALL
                   Secured Client IP = 0.0.0.0

SSH Server:        Port = 0           Access = ALL
                   Secured Client IP = 0.0.0.0

Web Server:        Port = 80          Access = ALL
                   Secured Client IP = 0.0.0.0

SNMP Service:      Port = 161         Access = ALL
                   Secured Client IP = 0.0.0.0

DNS Service:       Port = 53          Access = ALL
                   Secured Client IP = 0.0.0.0

Press ENTER to Confirm or ESC to Cancel:
Press Space Bar to Toggle.
    
```

Figure 37-1 Menu 24.11 – Remote Management Control

The following table describes the fields in this screen.

Table 37-1 Menu 24.11 – Remote Management Control

FIELD	DESCRIPTION	EXAMPLE
Telnet Server FTP Server SSH Server Web Server SNMP Service DNS Service	Each of these read-only labels denotes a service or protocol.	
Server Port	This field shows the port number for the service or protocol. You may change the port number if needed, but you must use the same port number to access the ZyWALL.	23
Server Access	Select the access interface (if any) by pressing [SPACE BAR], then [ENTER] to choose from: LAN only , DMZ only , WAN only , ALL or Disable .	LAN Only (default)

Table 37-1 Menu 24.11 – Remote Management Control

FIELD	DESCRIPTION	EXAMPLE
Secured Client IP	The default 0.0.0.0 allows any client to use this service or protocol to access the ZyWALL. Enter an IP address to restrict access to a client with a matching IP address.	0.0.0.0
Once you have filled in this menu, press [ENTER] at the message "Press ENTER to Confirm or ESC to Cancel" to save your configuration, or press [ESC] to cancel.		

37.1.1 Remote Management Limitations

Remote management over LAN or WAN will not work when:

1. A filter in menu 3.1 (LAN) or in menu 11.5 (WAN) is applied to block a Telnet, FTP or Web service.
2. You have disabled that service in menu 24.11.
3. The IP address in the **Secured Client IP** field (menu 24.11) does not match the client IP address. If it does not match, the ZyWALL will disconnect the session immediately.
4. There is an SMT console session running.
5. There is already another remote management session with an equal or higher priority running. You may only have one remote management session running at one time.
6. There is a firewall rule that blocks it

Part XIV:

SMT Advanced Management

This part provides information on how to configure IP Policy Routing, call scheduling, and VPN/IPSec.

See the web configurator parts of this guide for background information on features configurable by web configurator and SMT.

Chapter 38

IP Policy Routing

This chapter covers setting and applying policies used for IP routing.

38.1 Introduction to IP Policy Routing

Traditionally, routing is based on the destination address only and the ZyWALL takes the shortest path to forward a packet. IP Policy Routing (IPPR) provides a mechanism to override the default routing behavior and alter the packet forwarding based on the policy defined by the network administrator. Policy-based routing is applied to incoming packets on a per interface basis, prior to the normal routing. This feature is not available on all models.

38.2 Benefits

- Source-Based Routing – Network administrators can use policy-based routing to direct traffic from different users through different connections.
- Quality of Service (QoS) – Organizations can differentiate traffic by setting the precedence or ToS (Type of Service) values in the IP header at the periphery of the network to enable the backbone to prioritize traffic.
- Cost Savings – IPPR allows organizations to distribute interactive traffic on high-bandwidth, high-cost paths while using low-cost paths for batch traffic.
- Load Sharing – Network administrators can use IPPR to distribute traffic among multiple paths.

38.3 Routing Policy

Individual routing policies are used as part of the overall IPPR process. A policy defines the matching criteria and the action to take when a packet meets the criteria. The action is taken only when all the criteria are met. The criteria include the source address and port, IP protocol (ICMP, UDP, TCP, etc.), destination address and port, ToS and precedence (fields in the IP header) and length. The inclusion of length criterion

is to differentiate between interactive and bulk traffic. Interactive applications, e.g., telnet, tend to have short packets, while bulk traffic, e.g., file transfer, tends to have large packets.

The actions that can be taken include:

- Routing the packet to a different gateway (and hence the outgoing interface).
- Setting the ToS and precedence fields in the IP header.

IPPR follows the existing packet filtering facility of RAS in style and in implementation. The policies are divided into sets, where related policies are grouped together. A user defines the policies before applying them to an interface or a remote node, in the same fashion as the filters. There are 4 policy sets with six policies in each set.

38.4 IP Routing Policy Setup

Menu 25 shows all the policies defined.

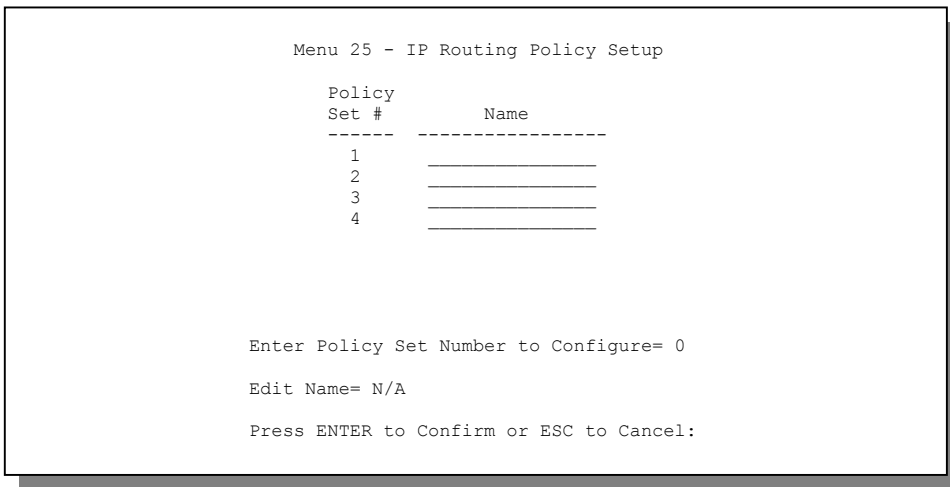

Figure 38-1 IP Routing Policy Setup

To setup a routing policy, perform the following procedures:

- Step 1.** Type 25 in the main menu to open **Menu 25 – IP Routing Policy Setup**.
- Step 2.** Type the index of the policy set you want to configure to open **Menu 25.1 – IP Routing Policy Setup**.

Menu 25.1 shows the summary of a policy set, including the criteria and the action of a single policy, and whether a policy is active or not. Each policy contains two lines. The former part is the criteria of the incoming packet and the latter is the action. Between these two parts, separator “|” means the action is taken on criteria matched and separator “=” means the action is taken on criteria not matched.

```

Menu 25.1 - IP Routing Policy Setup

# A          Criteria/Action
- - - - -
1 Y SA=1.1.1.1-1.1.1.1,DA=2.2.2.2-2.2.2.5
   SP=20-25,DP=20-25,P=6,T=NM,PR=0      |GW=192.168.1.1,T=MT,PR=0
2 N _____
3 N _____
4 N _____
5 N _____
6 N _____

Enter Policy Rule Number (1-6) to Configure:
    
```

Figure 38-3 Menu 25.1: Sample IP Routing Policy Setup

Table 38-1 IP Routing Policy Setup

ABBREVIATION		MEANING
Criterion	SA	Source IP Address
	SP	Source Port
	DA	Destination IP Address
	DP	Destination Port
	P	IP layer 4 protocol number (TCP=6, UDP=17...)
	T	Type of service of incoming packet
	PR	Precedence of incoming packet
Action	GW	Gateway IP address
	T	Outgoing Type of service
	P	Outgoing Precedence

Table 38-1 IP Routing Policy Setup

ABBREVIATION		MEANING
Service	NM	Normal
MD		Minimum Delay
MT		Maximum Throughput
MR		Maximum Reliability
MC		Minimum Cost

Type a number from 1 to 6 to display **Menu 25.1.1 – IP Routing Policy** (see the next figure). This menu allows you to configure a policy rule.

```

Menu 25.1.1 - IP Routing Policy

Policy Set Name= test
Active= Yes
Criteria:
  IP Protocol      = 6
  Type of Service= Normal
  Precedence      = 0
  Source:
    addr start= 1.1.1.1
    port start= 20
  Destination:
    addr start= 2.2.2.2
    port start= 20
  Action= Matched
  Gateway addr   = 192.168.1.1
  Type of Service= Max Thruput
  Precedence     = 0
  Packet length= 40
  Len Comp= N/A
  end= 1.1.1.1
  end= 20
  end= 2.2.2.2
  end= 20
  Log= No

Press ENTER to Confirm or ESC to Cancel:

Press Space Bar to Toggle.
    
```

Figure 38-4 IP Routing Policy

Table 38-2 IP Routing Policy

FIELD	DESCRIPTION
Policy Set Name	This is the policy set name assigned in Menu 25 – IP Routing Policy Setup .
Active	Press [SPACE BAR] and then [ENTER] to select Yes to activate the policy.
Criteria	

Table 38-2 IP Routing Policy

FIELD	DESCRIPTION
IP Protocol	Enter a number that represents an IP layer 4 protocol, for example, UDP=17, TCP=6, ICMP=1 and Don't care=0.
Type of Service	Prioritize incoming network traffic by choosing from Don't Care, Normal, Min Delay, Max Thruput or Max Reliable .
Precedence	Precedence value of the incoming packet. Press [SPACE BAR] and then [ENTER] to select a value from 0 to 7 or Don't Care .
Packet Length	Type the length of incoming packets (in bytes). The operators in the Len Comp (next field) apply to packets of this length.
Len Comp	Press [SPACE BAR] and then [ENTER] to choose from Equal, Not Equal, Less, Greater, Less or Equal or Greater or Equal .
Source	
addr start / end	Source IP address range from start to end.
port start / end	Source port number range from start to end; applicable only for TCP/UDP.
Destination	
addr start / end	Destination IP address range from start to end.
port start / end	Destination port number range from start to end; applicable only for TCP/UDP.
Action	Specifies whether action should be taken on criteria Matched or Not Matched .
Gateway addr	Defines the outgoing gateway address. The gateway must be on the same subnet as the ZYWALL if it is on the LAN, otherwise, the gateway must be the IP address of a remote node. The default gateway is specified as 0.0.0.0.
Type of Service	Set the new TOS value of the outgoing packet. Prioritize incoming network traffic by choosing No Change, Normal, Min Delay, Max Thruput, Max Reliable or Min Cost .
Precedence	Set the new outgoing packet precedence value. Values are 0 to 7 or No Change .
Log	Press [SPACE BAR] and then [ENTER] to select Yes to make an entry in the system log when a policy is executed.
When you have completed this menu, press [ENTER] at the prompt "Press [ENTER] to confirm or [ESC] to cancel" to save your configuration or press [ESC] to cancel and go back to the previous screen.	

38.5 Applying an IP Policy

This section shows you where to apply the IP policies after you design them.

38.5.1 Ethernet IP Policies

From **Menu 3 – Ethernet Setup**, type 2 to go to **Menu 3.2 – TCP/IP and DHCP Ethernet Setup**.

You can choose up to four IP policy sets (from 12) by typing their numbers separated by commas, for example, 2, 4, 7, 9.

```
Menu 3.2 - TCP/IP and DHCP Ethernet Setup

DHCP= Server
Configuration:
  Client IP Pool Starting Address= 192.168.1.33
  Size of Client IP Pool= 32
  Primary DNS Server= 0.0.0.0
  Secondary DNS Server= 0.0.0.0
  DHCP Server Address= N/A

TCP/IP Setup:
  IP Address= 192.168.1.1
  IP Subnet Mask= 255.255.255.0
  RIP Direction= Both
    Version= RIP-1
  Multicast= None
  Edit IP Alias= No
  IP Policies= 2,4,7,9

Press ENTER to Confirm or ESC to Cancel:
Press Space Bar to Toggle.
```

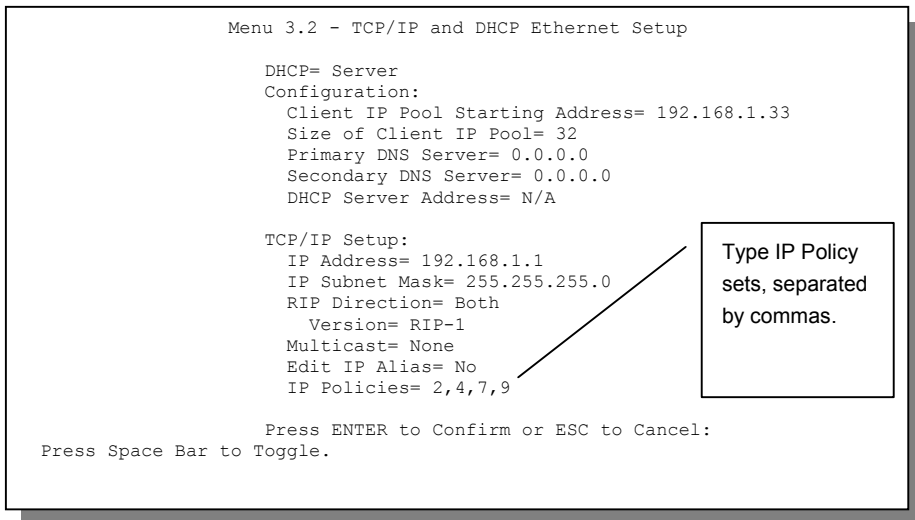

Figure 38-5 Menu 3.2: TCP/IP and DHCP Ethernet Setup

38.6 IP Policy Routing Example

If a network has both Internet and remote node connections, you can route Web packets to the Internet using one policy and route FTP packets to a remote network using another policy. See the next figure.

Route 1 represents the default IP route and route 2 represents the configured IP route.

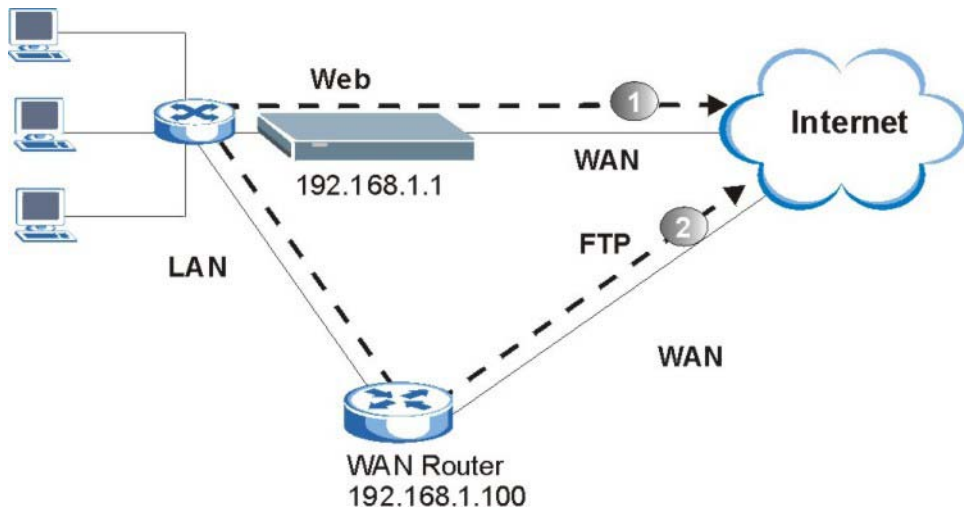

Figure 38-6 Example of IP Policy Routing

To force Web packets coming from clients with IP addresses of 192.168.1.33 to 192.168.1.64 to be routed to the Internet via the WAN port of the ZyWALL, follow the steps as shown next.

Step 1. Create a routing policy set in menu 25.

Step 2. Create a rule for this set in **Menu 25.1.1 - IP Routing Policy** as shown next.

```
Menu 25.1.1 - IP Routing Policy

Policy Set Name= set1
Active= Yes
Criteria:
  IP Protocol      = 6
  Type of Service= Don't Care
  Precedence      = Don't Care
  Packet length= 10
  Len Comp= N/A
Source:
  addr start= 192.168.1.2
  port start= 0
  end= 192.168.1.64
  end= N/A
Destination:
  addr start= 0.0.0.0
  port start= 80
  end= N/A
  end= 80
Action= Matched
Gateway addr  = 192.168.1.1
Type of Service= No Change
Precedence   = No Change

Press ENTER to Confirm or ESC to Cancel:
Press Space Bar to Toggle.
```

Figure 38-7 IP Routing Policy Example

Step 3. Check **Menu 25.1 - IP Routing Policy Setup** to see if the rule is added correctly.

Step 4. Create another policy set in menu 25.

- Step 5.** Create a rule in menu 25.1.1 for this set to route packets from any host (IP=0.0.0.0 means any host) with protocol TCP and port FTP access through another gateway (192.168.1.100).

```
Menu 25.1.1 - IP Routing Policy

Policy Set Name= set2

Active= Yes
Criteria:
  IP Protocol      = 6
  Type of Service = Don't Care
  Precedence       = Don't Care
  Packet length= 10
  Len Comp= N/A
Source:
  addr start= 0.0.0.0
  port start= 0
  end= N/A
  end= N/A
Destination:
  addr start= 0.0.0.0
  port start= 20
  end= N/A
  end= 21
Action= Matched
Gateway addr =192.168.1.100
Log= No
Type of Service= No Change
Precedence = No Change

Press ENTER to Confirm or ESC to Cancel:
Press Space Bar to Toggle.
```

Figure 38-8 IP Routing Policy

- Step 6.** Check **Menu 25.1 - IP Routing Policy Setup** to see if the rule is added correctly.
- Step 7.** Apply both policy sets in menu 3.2 as shown next.

```
Menu 3.2 - TCP/IP and DHCP Ethernet Setup

DHCP Setup
  DHCP= Server
  Client IP Pool Starting Address= 192.168.1.33
  Size of Client IP Pool= 64
  Primary DNS Server= 0.0.0.0
  Secondary DNS Server= 0.0.0.0
  Remote DHCP Server= N/A
TCP/IP Setup:
  IP Address= 192.168.1.1
  IP Subnet Mask= 255.255.255.0
  RIP Direction= Both
  Version= RIP-1
  Multicast= None
  IP Policies= 1,2
  Edit IP Alias= No

Press ENTER to Confirm or ESC to Cancel:

Press Space Bar to Toggle.
```

Figure 38-9 Applying IP Policies

Chapter 39

Call Scheduling

Call scheduling allows you to dictate when a remote node should be called and for how long.

39.1 Introduction to Call Scheduling

The call scheduling feature allows the ZyWALL to manage a remote node and dictate when a remote node should be called and for how long. This feature is similar to the scheduler in a videocassette recorder (you can specify a time period for the VCR to record). You can apply up to 4 schedule sets in **Menu 11.1 - Remote Node Profile**. From the main menu, enter 26 to access **Menu 26 - Schedule Setup** as shown next.

Menu 26 - Schedule Setup			
Schedule Set #	Name	Schedule Set #	Name
1	_____	7	_____
2	_____	8	_____
3	_____	9	_____
4	_____	10	_____
5	_____	11	_____
6	_____	12	_____

Enter Schedule Set Number to Configure=
 Edit Name=
 Press ENTER to Confirm or ESC to Cancel:

Figure 39-1 Schedule Setup

Lower numbered sets take precedence over higher numbered sets thereby avoiding scheduling conflicts. For example, if sets 1, 2, 3 and 4 are applied in the remote node, then set 1 will take precedence over set 2, 3 and 4 as the ZyWALL, by default, applies the lowest numbered set first. Set 2 will take precedence over set 3 and 4, and so on.

You can design up to 12 schedule sets but you can only apply up to four schedule sets for a remote node.

To delete a schedule set, enter the set number and press [SPACE BAR] and then [ENTER] or [DEL] in the Edit Name field.

To set up a schedule set, select the schedule set you want to setup from menu 26 (1-12) and press [ENTER] to see **Menu 26.1 - Schedule Set Setup** as shown next.

```

Menu 26.1 - Schedule Set Setup

Active= Yes
Start Date (yyyy/mm/dd) = 2000 - 01 - 01
How Often= Once
Once:
  Date (yyyy/mm/dd)= 2000 - 01 - 01
Weekdays:
  Sunday= N/A
  Monday= N/A
  Tuesday= N/A
  Wednesday= N/A
  Thursday= N/A
  Friday= N/A
  Saturday= N/A
Start Time (hh:mm)= 00 : 00
Duration (hh:mm)= 00 : 00
Action= Forced On

Press ENTER to Confirm or ESC to Cancel:
Press Space Bar to Toggle
    
```

Figure 39-2 Schedule Set Setup

If a connection has been already established, your ZyWALL will not drop it. Once the connection is dropped manually or it times out, then that remote node can't be triggered up until the end of the **Duration**.

Table 39-1 Schedule Set Setup Fields

FIELD	DESCRIPTION	OPTIONS
Active	Press [SPACE BAR] to select Yes or No . Choose Yes and press [ENTER] to activate the schedule set.	Yes No
Start Date	Enter the start date when you wish the set to take effect in year -month-date format. Valid dates are from the present to 2036-February-5.	
How Often	Should this schedule set recur weekly or be used just once only? Press [SPACE BAR] and then [ENTER] to select Once or Weekly . Both these options are mutually exclusive. If Once is selected, then all weekday settings are N/A . When Once is selected, the schedule rule deletes automatically after the scheduled time elapses.	Once Weekly
Once: Date	If you selected Once in the How Often field above, then enter the date the set should activate here in year-month-date format.	

Table 39-1 Schedule Set Setup Fields

FIELD	DESCRIPTION	OPTIONS
Weekday: Day	If you selected Weekly in the How Often field above, then select the day(s) when the set should activate (and recur) by going to that day(s) and pressing [SPACE BAR] to select Yes , then press [ENTER].	Yes No N/A
Start Time	Enter the start time when you wish the schedule set to take effect in hour-minute format.	
Duration	Enter the maximum length of time this connection is allowed in hour-minute format.	
Action	<p>Forced On means that the connection is maintained whether or not there is a demand call on the line and will persist for the time period specified in the Duration field.</p> <p>Forced Down means that the connection is blocked whether or not there is a demand call on the line.</p> <p>Enable Dial-On-Demand means that this schedule permits a demand call on the line.</p> <p>Disable Dial-On-Demand means that this schedule prevents a demand call on the line.</p>	Forced On Forced Down Enable Dial-On-Demand Disable Dial-On-Demand
When you have completed this menu, press [ENTER] at the prompt "Press ENTER to Confirm..." to save your configuration, or press [ESC] at any time to cancel.		

Once your schedule sets are configured, you must then apply them to the desired remote node(s). Enter 11 from the Main Menu and then enter the target remote node index. Press [SPACE BAR] and then [ENTER] to select **PPPoE** in the **Encapsulation** field to make the schedule sets field available as shown next.

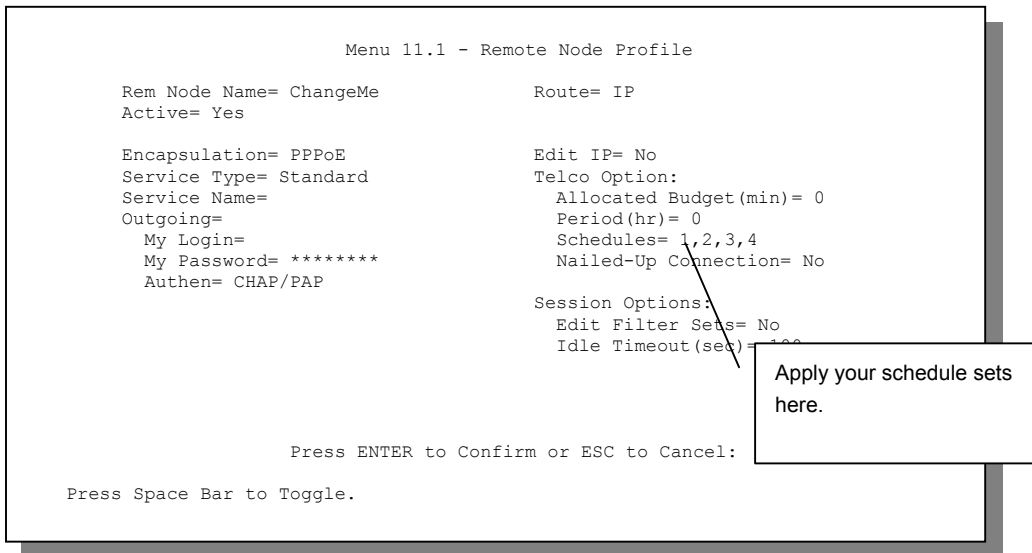

Figure 39-3 Applying Schedule Set(s) to a Remote Node (PPPoE)

You can apply up to four schedule sets, separated by commas, for one remote node. Change the schedule set numbers to your preference(s).

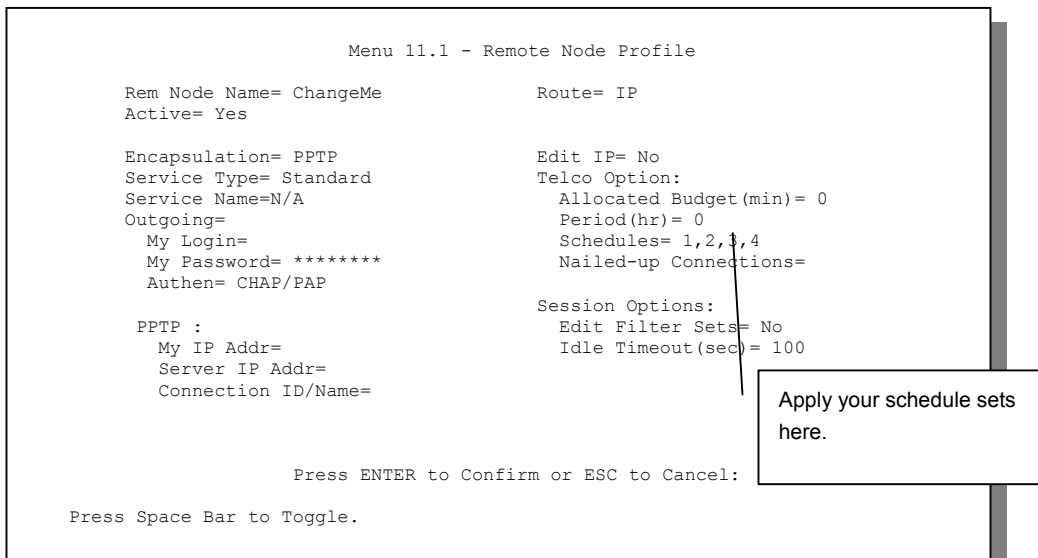

Figure 39-4 Applying Schedule Set(s) to a Remote Node (PPTP)

Chapter 40

VPN/IPSec Setup

This chapter introduces the VPN SMT menus.

40.1 Introduction

The VPN/IPSec main SMT menu has these main submenus:

1. Define VPN policies in menu 27.1 submenus, including security policies, endpoint IP addresses, peer IPSec router IP address and key management.
2. **Menu 27.2 - SA Monitor** allows you to manage (refresh or disconnect) your SA connections.

This is an overview of the VPN menu tree.

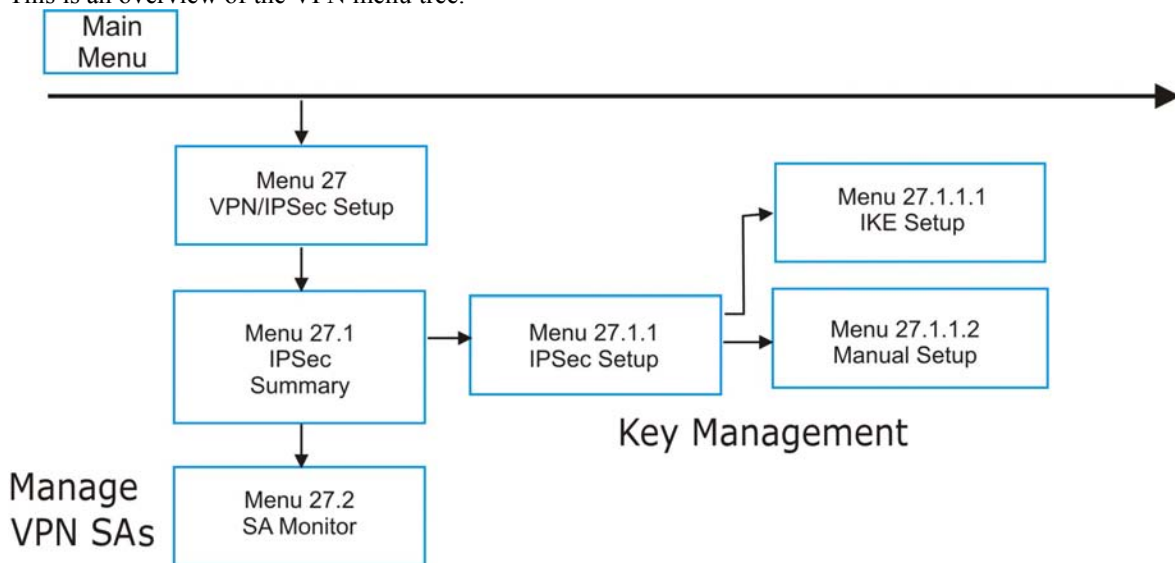

Figure 40-1 VPN SMT Menu Tree

From the main menu, enter 27 to display the first VPN menu (shown next).

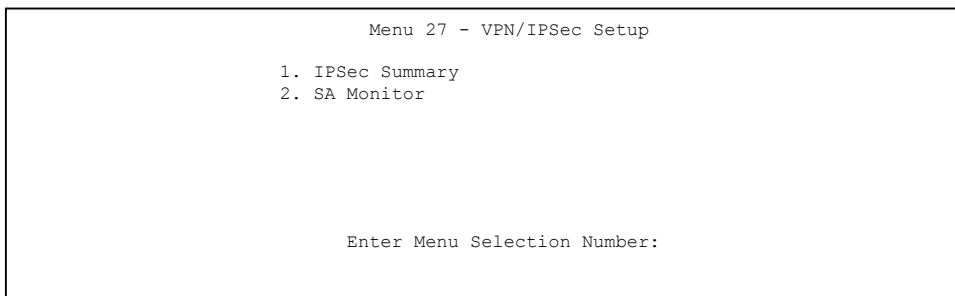

Figure 40-2 Menu 27: VPN/IPSec Setup

40.2 IPSec Summary Screen

Type 1 in menu 27 and then press [ENTER] to display **Menu 27.1 — IPSec Summary**. This is a summary read-only menu of your IPSec rules (tunnels). Edit or create an IPSec rule by selecting an index number and then configuring the associated submenus.

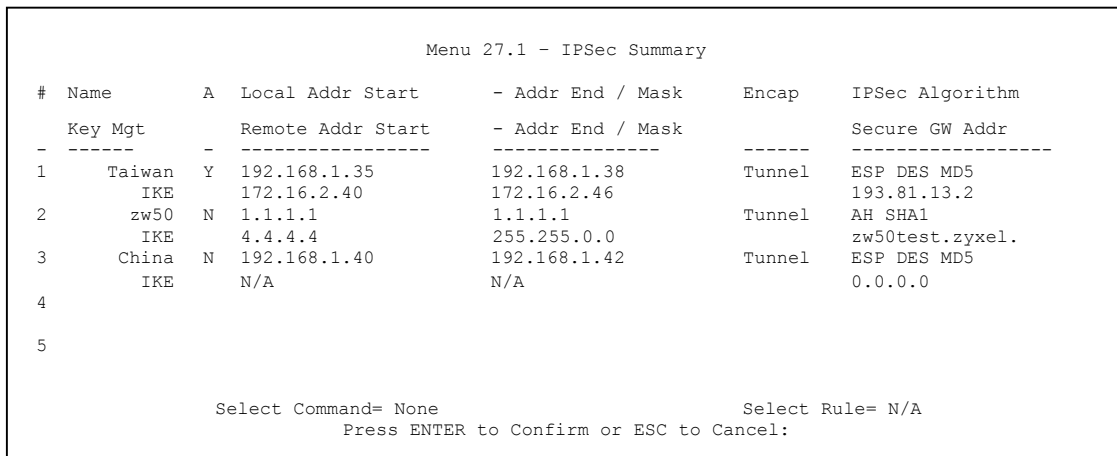

Figure 40-3 Menu 27.1: IPSec Summary

Table 40-1 Menu 27.1: IPSec Summary

FIELD	DESCRIPTION	EXAMPLE
#	This is the VPN policy index number.	1

Table 40-1 Menu 27.1: IPSec Summary

FIELD	DESCRIPTION	EXAMPLE
Name	This field displays the unique identification name for this VPN rule. The name may be up to 32 characters long but only 10 characters will be displayed here.	Taiwan
A	Y signifies that this VPN rule is active.	Y
Local Addr Start	<p>When the Addr Type field in Menu 27.1.1 IPSec Setup is configured to Single, this is a static IP address on the LAN behind your ZyWALL.</p> <p>When the Addr Type field in Menu 27.1.1 IPSec Setup is configured to Range, this is the beginning (static) IP address, in a range of computers on the LAN behind your ZyWALL.</p> <p>When the Addr Type field in Menu 27.1.1 IPSec Setup is configured to SUBNET, this is a static IP address on the LAN behind your ZyWALL.</p>	192.168.1.35
Addr End / Mask	<p>When the Addr Type field in Menu 27.1.1 IPSec Setup is configured to Single, this is the same (static) IP address as in the Local Addr Start field.</p> <p>When the Addr Type field in Menu 27.1.1 IPSec Setup is configured to Range, this is the end (static) IP address, in a range of computers on the LAN behind your ZyWALL.</p> <p>When the Addr Type field in Menu 27.1.1 IPSec Setup is configured to SUBNET, this is a subnet mask on the LAN behind your ZyWALL.</p>	192.168.1.38
Encap	This field displays Tunnel mode or Transport mode. See earlier for a discussion of these. You need to finish configuring the VPN policy in menu 27.1.1.1 or 27.1.1.2 if ??? is displayed.	Tunnel
IPSec Algorithm	<p>This field displays the security protocols used for an SA. ESP provides confidentiality and integrity of data by encrypting the data and encapsulating it into IP packets. Encryption methods include 56-bit DES, 168-bit 3DES and 128-bit AES. NULL denotes a tunnel without encryption.</p> <p>AH (Authentication Header) provides strong integrity and authentication by adding authentication information to IP packets. This authentication information is calculated using header and payload data in the IP packet. This provides an additional level of security. AH choices are MD5 (default - 128 bits) and SHA -1(160 bits).</p> <p>Both AH and ESP increase the ZyWALL's processing requirements and communications latency (delay).</p> <p>You need to finish configuring the VPN policy in menu 27.1.1.1 or 27.1.1.2 if ??? is displayed.</p>	ESP DES MD5

Table 40-1 Menu 27.1: IPSec Summary

FIELD	DESCRIPTION	EXAMPLE
Key Mgt	This field displays the SA's type of key management, (IKE or Manual).	IKE
Remote Addr Start	<p>When the Addr Type field in Menu 27.1.1 IPSec Setup is configured to Single, this is a static IP address on the network behind the remote IPSec router.</p> <p>When the Addr Type field in Menu 27.1.1 IPSec Setup is configured to Range, this is the beginning (static) IP address, in a range of computers on the network behind the remote IPSec router.</p> <p>When the Addr Type field in Menu 27.1.1 IPSec Setup is configured to SUBNET, this is a static IP address on the network behind the remote IPSec router.</p> <p>This field displays N/A when you configure the Secure Gateway Address field in SMT 27.1.1 to 0.0.0.0.</p>	172.16.2.40
Addr End / Mask	<p>When the Addr Type field in Menu 27.1.1 IPSec Setup is configured to Single, this is the same (static) IP address as in the Remote Addr Start field.</p> <p>When the Addr Type field in Menu 27.1.1 IPSec Setup is configured to Range, this is the end (static) IP address, in a range of computers on the network behind the remote IPSec router.</p> <p>When the Addr Type field in Menu 27.1.1 IPSec Setup is configured to SUBNET, this is a subnet mask on the network behind the remote IPSec router.</p> <p>This field displays N/A when you configure the Secure Gateway Address field in SMT 27.1.1 to 0.0.0.0.</p>	172.16.2.46
Secure GW Addr	This is the WAN IP address or the domain name (up to the first 15 characters are displayed) of the IPSec router with which you are making the VPN connection. This field displays 0.0.0.0 when you configure the Secure Gateway Address field in SMT 27.1.1 to 0.0.0.0.	193.81.13.2

Table 40-1 Menu 27.1: IPSec Summary

FIELD	DESCRIPTION	EXAMPLE
Select Command	<p>Press [SPACE BAR] to choose from None, Edit, Delete, Go To Rule, Next Page or Previous Page and then press [ENTER]. You must select a rule in the next field when you choose the Edit, Delete or Go To commands.</p> <p>Select None and then press [ENTER] to go to the “Press ENTER to Confirm...” prompt.</p> <p>Use Edit to create or edit a rule. Use Delete to remove a rule. To edit or delete a rule, first make sure you are on the correct page. When a VPN rule is deleted, subsequent rules do <u>not</u> move up in the page list.</p> <p>Use Go To Rule to view the page where your desired rule is listed.</p> <p>Select Next Page or Previous Page to view the next or previous page of rules (respectively).</p>	None
Select Rule	Type the VPN rule index number you wish to edit or delete and then press [ENTER].	3
When you have completed this menu, press [ENTER] at the prompt “Press ENTER to Confirm...” to save your configuration, or press [ESC] at any time to cancel.		

40.3 IPSec Setup

Select **Edit** in the **Select Command** field; type the index number of a rule in the **Select Rule** field and press [ENTER] to edit the VPN using the menu shown next.

```

Menu 27.1.1 - IPSec Setup

Index= 1          Name= Taiwan
Active= Yes      Keep Alive= No    NAT Traversal= No
Local ID type    Content:
My IP Addr= 0.0.0.0
Peer ID type     Content:
Secure Gateway Address= zw50test.zyxel.com.tw
Protocol= 0
Local:
  Addr Type= SINGLE
  IP Addr Start= 1.1.1.1          End= N/A
  Port Start= 0                  End= N/A
Remote:
  Addr Type= SUBNET
  IP Addr Start= 4.4.4.4        End= 255.255.0.0
  Port Start= 0                 End= N/A
Enable Replay Detection = No
Key Management= IKE
Edit Key Management Setup= No

Press ENTER to Confirm or ESC to Cancel:

```

Figure 40-4 Menu 27.1.1: IPSec Setup

You must also configure menu 27.1.1.1 or menu 27.1.1.2 to fully configure and use a VPN.

Table 40-2 Menu 27.1.1: IPSec Setup

FIELD	DESCRIPTION	EXAMPLE
Index	This is the VPN rule index number you selected in the previous menu.	1
Name	Enter a unique identification name for this VPN rule. The name may be up to 32 characters long but only 10 characters will be displayed in Menu 27.1 - IPSec Summary .	Taiwan
Active	Press [SPACE BAR] to choose either Yes or No . Choose Yes and press [ENTER] to activate the VPN tunnel. This field determines whether a VPN rule is applied before a packet leaves the firewall.	Yes
Keep Alive	Press [SPACE BAR] to choose either Yes or No . Choose Yes and press [ENTER] to have the ZyWALL automatically re-initiate the SA after the SA lifetime times out, even if there is no traffic. The remote IPSec router must also have keep alive enabled in order for this feature to work.	No

Table 40-2 Menu 27.1.1: IPSec Setup

FIELD	DESCRIPTION	EXAMPLE
NAT Traversal	<p>Select this check box to enable NAT traversal. NAT traversal allows you to set up a VPN connection when there are NAT routers between the two IPSec routers.</p> <p>The remote IPSec router must also have NAT traversal enabled. You can use NAT traversal with ESP protocol using Transport or Tunnel mode, but not with AH protocol nor with Manual key management.</p> <p>In order for an IPSec router behind a NAT router to receive an initiating IPSec packet, set the NAT router to forward UDP port 500 to the IPSec router behind the NAT router.</p>	No
Local ID type	<p>Press [SPACE BAR] to choose IP, DNS, or E-mail and press [ENTER].</p> <p>Select IP to identify this ZyWALL by its IP address. Select DNS to identify this ZyWALL by a domain name. Select E-mail to identify this ZyWALL by an e-mail address.</p> <p>The Local ID type and Content fields display N/A when you set Authentication Method to Certificate in Menu 27.1.1.1 IKE Setup (see the Edit Key Management Setup field). The ZyWALL takes the local ID type and content from the certificate you select.</p>	
Content	<p>When you select IP in the Local ID type field, type the IP address of your computer in the local Content field. The ZyWALL automatically uses the IP address in the My IP Address field (refer to the My IP Address field description) if you configure the local Content field to 0.0.0.0 or leave it blank.</p> <p>It is recommended that you type an IP address other than 0.0.0.0 in the local Content field or use the DNS or E-mail ID type in the following situations.</p> <ul style="list-style-type: none"> ➤ When there is a NAT router between the two IPSec routers. ➤ When you want the remote IPSec router to be able to distinguish between VPN connection requests that come in from IPSec routers with dynamic WAN IP addresses. <p>When you select DNS or E-mail in the Local ID type field, type a domain name or e-mail address by which to identify this ZyWALL in the local Content field. Use up to 31 ASCII characters including spaces, although trailing spaces are truncated. The domain name or e-mail address is for identification purposes only and can be any string.</p>	

Table 40-2 Menu 27.1.1: IPSec Setup

FIELD	DESCRIPTION	EXAMPLE
My IP Addr	<p>Enter the IP address of your ZyWALL. The ZyWALL uses its current WAN IP address (static or dynamic) in setting up the VPN tunnel if you leave this field as 0.0.0.0.</p> <p>The VPN tunnel has to be rebuilt if this IP address changes.</p>	0.0.0.0
Peer ID type	<p>Press [SPACE BAR] to choose IP, DNS, or E-mail and press [ENTER].</p> <p>Select from the following when you set Authentication Method to Pre-Shared Key in Menu 27.1.1.1 IKE Setup (see the Edit Key Management Setup field).</p> <ul style="list-style-type: none">➤ Select IP to identify the remote IPSec router by its IP address.➤ Select DNS to identify the remote IPSec router by a domain name.➤ Select E-mail to identify the remote IPSec router by an e-mail address. <p>Then Peer ID type and Content fields display N/A when you set Authentication Method to Certificate and you must use the web configurator or CLI command interpreter to configure the peer ID type and content.</p>	

Table 40-2 Menu 27.1.1: IPSec Setup

FIELD	DESCRIPTION		EXAMPLE
Content	Peer ID Type	Peer ID Content when you set Authentication Method to Pre-Shared Key .	
	IP	Type the IP address of the computer with which you will make the VPN connection. If you configure this field to 0.0.0.0 or leave it blank, the ZyWALL will use the address in the Secure Gateway Address field.	
	DNS or E-Mail	Type a domain name or e-mail address by which to identify the remote IPSec router. Use up to 31 ASCII characters including spaces, although trailing spaces are truncated. The domain name or e-mail address is for identification purposes only and can be any string.	
<p>It is recommended that you type an IP address other than 0.0.0.0 or use the DNS or E-mail Peer ID Type with the following situations:</p> <ul style="list-style-type: none"> ➤ There is a NAT router between the two IPSec routers. ➤ You want the ZyWALL to distinguish between VPN connection requests coming in from remote IPSec routers with dynamic WAN IP addresses. <p>With either Authentication Method (Pre-Shared Key or Certificate) in menu 27.1.1.1, if you use IP as the peer ID type and configure the content as 0.0.0.0 (or blank) and the Secure Gateway Address is also configured as 0.0.0.0, the ZyWALL does not check the peer's ID content.</p> <p>Regardless of how you configure the ID Type and Content fields, active rules cannot have overlapping local and remote IP address ranges.</p>			
Secure Gateway Address	<p>Type the IP address or the domain name (up to 31 characters) of the IPSec router with which you're making the VPN connection.</p> <p>Set this field to 0.0.0.0 if the remote IPSec router has a dynamic WAN IP address (the Key Management field must be set to IKE, see later).</p>		Zw50test.com. tw
Protocol	Enter 1 for ICMP, 6 for TCP, 17 for UDP, etc. 0 is the default and signifies any protocol.		0
Local	<p>Local IP addresses must be static and correspond to the remote IPSec router's configured remote IP addresses.</p> <p>Two active SAs cannot have the local and remote IP address(es) both the same. Two active SAs can have the same local or remote IP address, but not both. You can configure multiple SAs between the same local and remote IP addresses, as long as only one is active at any time.</p>		

Table 40-2 Menu 27.1.1: IPSec Setup

FIELD	DESCRIPTION	EXAMPLE
Addr Type	Press [SPACE BAR] to choose SINGLE , RANGE , or SUBNET and press [ENTER]. Select SINGLE with a single IP address. Select RANGE for a specific range of IP addresses. Select SUBNET to specify IP addresses on a network by their subnet mask.	SINGLE
IP Addr Start	When the Addr Type field is configured to Single , enter a static IP address on the LAN behind your ZyWALL. When the Addr Type field is configured to Range , enter the beginning (static) IP address, in a range of computers on your LAN behind your ZyWALL. When the Addr Type is configured to SUBNET , this is a (static) IP address on the LAN behind your ZyWALL.	192.168.1.35
End	When the Addr Type field is configured to Single , this field is N/A . When the Addr Type field is configured to Range , enter the end (static) IP address, in a range of computers on the LAN behind your ZyWALL. When the Addr Type field is configured to SUBNET , this is a subnet mask on the LAN behind your ZyWALL.	192.168.1.38
Port Start	0 is the default and signifies any port. Type a port number from 0 to 65535. You cannot create a VPN tunnel if you try to connect using a port number that does not match this port number or range of port numbers. Some of the most common IP ports are: 21, FTP; 53, DNS; 23, Telnet; 80, HTTP; 25, SMTP; 110, POP3	0
End	Enter a port number in this field to define a port range. This port number must be greater than that specified in the previous field. This field is N/A when 0 is configured in the Port Start field.	N/A
Remote	Remote IP addresses must be static and correspond to the remote IPSec router's configured local IP addresses. The remote fields are N/A when the Secure Gateway Address field is configured to 0.0.0.0. Two active SAs cannot have the local and remote IP address(es) both the same. Two active SAs can have the same local or remote IP address, but not both. You can configure multiple SAs between the same local and remote IP addresses, as long as only one is active at any time.	
Addr Type	Press [SPACE BAR] to choose SINGLE , RANGE , or SUBNET and press [ENTER]. Select SINGLE with a single IP address. Use RANGE for a specific range of IP addresses. Use SUBNET to specify IP addresses on a network by their subnet mask.	SUBNET

Table 40-2 Menu 27.1.1: IPSec Setup

FIELD	DESCRIPTION	EXAMPLE
IP Addr Start	<p>When the Addr Type field is configured to Single, enter a static IP address on the network behind the remote IPSec router.</p> <p>When the Addr Type field is configured to Range, enter the beginning (static) IP address, in a range of computers on the network behind the remote IPSec router.</p> <p>When the Addr Type field is configured to SUBNET, enter a static IP address on the network behind the remote IPSec router.</p> <p>This field displays N/A when you configure the Secure Gateway Address field to 0.0.0.0.</p>	4.4.4.4
End	<p>When the Addr Type field is configured to Single, this field is N/A.</p> <p>When the Addr Type field is configured to Range, enter the end (static) IP address, in a range of computers on the network behind the remote IPSec router.</p> <p>When the Addr Type field is configured to SUBNET, enter a subnet mask on the network behind the remote IPSec router.</p> <p>This field displays N/A when you configure the Secure Gateway Address field to 0.0.0.0.</p>	255.255.0.0
Port Start	<p>0 is the default and signifies any port. Type a port number from 0 to 65535. Someone behind the remote IPSec router cannot create a VPN tunnel when attempting to connect using a port number that does not match this port number or range of port numbers.</p> <p>Some of the most common IP ports are: 21, FTP; 53, DNS; 23, Telnet; 80, HTTP; 25, SMTP; 110, POP3.</p>	0
End	<p>Enter a port number in this field to define a port range. This port number must be greater than that specified in the previous field. This field is N/A when 0 is configured in the Port Start field.</p>	
Enable Replay Detection	<p>As a VPN setup is processing intensive, the system is vulnerable to Denial of Service (DoS) attacks. The IPSec receiver can detect and reject old or duplicate packets to protect against replay attacks. Enable replay detection by setting this field to Yes.</p> <p>Press [SPACE BAR] to select Yes or No. Choose Yes and press [ENTER] to enable replay detection.</p>	No

Table 40-2 Menu 27.1.1: IPSec Setup

FIELD	DESCRIPTION	EXAMPLE
Key Management	Press [SPACE BAR] to choose either IKE or Manual and then press [ENTER]. Manual is useful for troubleshooting if you have problems using IKE key management.	IKE
Edit Key Management Setup	Press [SPACE BAR] to change the default No to Yes and then press [ENTER] to go to a key management menu for configuring your key management setup (described later). If you set the Key Management field to IKE , this will take you to Menu 27.1.1.1 – IKE Setup . If you set the Key Management field to Manual , this will take you to Menu 27.1.1.2 – Manual Setup .	No
When you have completed this menu, press [ENTER] at the prompt “Press ENTER to Confirm...” to save your configuration, or press [ESC] at any time to cancel.		

40.4 IKE Setup

To edit this menu, the **Key Management** field **Menu 27.1.1 – IPSec Setup** must be set to **IKE**. Move the cursor to the **Edit Key Management Setup** field in **Menu 27.1.1 – IPSec Setup**; press [SPACE BAR] to select **Yes** and then press [ENTER] to display **Menu 27.1.1.1 – IKE Setup**.

```

Menu 27.1.1.1 - IKE Setup

Phase 1
Negotiation Mode= Main
Authentication Method= Pre-Shared Key
Pre-Shared Key =
Certificate=
Encryption Algorithm = DES
Authentication Algorithm = SHA1
SA Life Time (Seconds)= 28800
Key Group= DH1

Phase 2
Active Protocol = ESP
Encryption Algorithm = DES
Authentication Algorithm = SHA1
SA Life Time (Seconds)= 28800
Encapsulation = Tunnel
Perfect Forward Secrecy (PFS)= None

Press ENTER to Confirm or ESC to Cancel:

```

Figure 40-5 Menu 27.1.1.1: IKE Setup

Table 40-3 Menu 27.1.1.1: IKE Setup

FIELD	DESCRIPTION	EXAMPLE
Phase 1		
Negotiation Mode	Press [SPACE BAR] to choose from Main or Aggressive and then press [ENTER]. See earlier for a discussion of these modes. Multiple SAs connecting through a secure gateway must have the same negotiation mode.	Main
Authentication Method	Select Pre-Shared Key to use a pre-shared key to identify the ZyWALL and the remote IPSec router. A pre-shared key identifies a communicating party during a phase 1 IKE negotiation. It is called "pre-shared" because you have to share it with another party before you can communicate with them over a secure connection. Select Certificate to identify the ZyWALL and the remote IPSec router by certificates.	
Pre-Shared Key	ZyWALL gateways authenticate an IKE VPN session by matching pre-shared keys. Pre-shared keys are best for small networks with fewer than ten nodes. Enter your pre-shared key here. Enter up to 31 characters. Any character may be used, including spaces, but trailing spaces are truncated. Both ends of the VPN tunnel must use the same pre-shared key. You will receive a "PYLD_MALFORMED" (payload malformed) packet if the same pre-shared key is not used on both ends.	
Certificate	Select the certificate to use for this VPN tunnel. You must have certificates already configured in the My Certificates screen (see the web configurator <i>Certificates</i> part for details).	
Encryption Algorithm	The ZyWALL and the remote IPSec router generate an encryption key from the Diffie-Hellman key exchange. ZyWALL DES encryption algorithm uses a 56-bit key. Triple DES (3DES), is a variation on DES that uses a 168-bit key. As a result, 3DES is more secure than DES . It also requires more processing power, resulting in slightly increased latency and decreased throughput. This implementation of AES uses a 128-bit key. AES is faster than 3DES . Press [SPACE BAR] to choose from DES , 3DES or AES and then press [ENTER].	DES
Authentication Algorithm	MD5 (Message Digest 5) and SHA1 (Secure Hash Algorithm) are hash algorithms used to authenticate packet data. The SHA1 algorithm is generally considered stronger than MD5 , but is slightly slower. Press [SPACE BAR] to choose from SHA1 or MD5 and then press [ENTER].	SHA1

Table 40-3 Menu 27.1.1.1: IKE Setup

FIELD	DESCRIPTION	EXAMPLE
SA Life Time (Seconds)	Define the length of time before an IKE Security Association automatically renegotiates in this field. It may range from 60 to 3,000,000 seconds (almost 35 days). A short SA Life Time increases security by forcing the two VPN gateways to update the encryption and authentication keys. However, every time the VPN tunnel renegotiates, all users accessing remote resources are temporarily disconnected.	28800 (default)
Key Group	You must choose a key group for phase 1 IKE setup. DH1 (default) refers to Diffie-Hellman Group 1 a 768 bit random number. DH2 refers to Diffie-Hellman Group 2 a 1024 bit (1Kb) random number.	DH1
Phase 2		
Active Protocol	Press [SPACE BAR] to choose from ESP or AH and then press [ENTER]. See earlier for a discussion of these protocols.	ESP
Encryption Algorithm	Press [SPACE BAR] to choose from NULL , DES , 3DES or AES and then press [ENTER]. Select NULL to set up a tunnel without encryption.	DES
Authentication Algorithm	Press [SPACE BAR] to choose from SHA1 or MD5 and then press [ENTER].	MD5
SA Life Time (Seconds)	Define the length of time before an IPSec Security Association automatically renegotiates in this field. It may range from 60 to 3,000,000 seconds (almost 35 days).	28800 (default)
Encapsulation	Press [SPACE BAR] to choose from Tunnel mode or Transport mode and then press [ENTER]. See earlier for a discussion of these.	Tunnel
Perfect Forward Secrecy (PFS)	Perfect Forward Secrecy (PFS) is disabled (None) by default in phase 2 IPSec SA setup. This allows faster IPSec setup, but is not so secure. Press [SPACE BAR] and choose from DH1 or DH2 to enable PFS. DH1 refers to Diffie-Hellman Group 1 a 768 bit random number. DH2 refers to Diffie-Hellman Group 2 a 1024 bit (1Kb) random number (more secure, yet slower).	None
When you have completed this menu, press [ENTER] at the prompt "Press ENTER to Confirm..." to save your configuration, or press [ESC] at any time to cancel.		

40.5 Manual Setup

You only configure **Menu 27.1.1.2 – Manual Setup** when you select **Manual** in the **Key Management** field in **Menu 27.1.1 – IPSec Setup**. Manual key management is useful if you have problems with **IKE** key management.

40.5.1 Active Protocol

This field is a combination of mode and security protocols used for the VPN. See the web configurator parts of this *User's Guide* for more information on these parameters.

Table 40-4 Active Protocol: Encapsulation and Security Protocol

MODE	SECURITY PROTOCOL
Tunnel	ESP
Transport	AH

40.5.2 Security Parameter Index (SPI)

To edit this menu, move the cursor to the **Edit Manual Setup** field in **Menu 27.1.1 – IPsec Setup** press [SPACE BAR] to select **Yes** and then press [ENTER] to go to **Menu 27.1.1.2 – Manual Setup**.

```

Menu 27.1.1.2 - Manual Setup
Active Protocol= ESP Tunnel

ESP Setup
SPI (Decimal)=
Encryption Algorithm= DES
Key1=
Key2= N/A
Key3= N/A
Authentication Algorithm= MD5
Key= N/A

AH Setup
SPI (Decimal)= N/A
Authentication Algorithm= N/A
Key=

Press ENTER to Confirm or ESC to Cancel:

```

Figure 40-6 Menu 27.1.1.2: Manual Setup

Table 40-5 Menu 27.1.1.2: Manual Setup

FIELD	DESCRIPTION	EXAMPLE
Active Protocol	Press [SPACE BAR] to choose from ESP Tunnel , ESP Transport , AH Tunnel or AH Transport and then press [ENTER]. Choosing an ESP combination causes the AH Setup fields to be non-applicable (N/A)	ESP Tunnel
ESP Setup	The ESP Setup fields are N/A if you chose an AH Active Protocol .	
SPI (Decimal)	The SPI must be unique and from one to four integers ("0" to "9").	1234

Table 40-5 Menu 27.1.1.2: Manual Setup

FIELD	DESCRIPTION	EXAMPLE
Encryption Algorithm	Press [SPACE BAR] to choose from NULL , DES and 3DES and then press [ENTER]. Fill in the Key1 field below when you choose DES and fill in fields Key1 to Key3 when you choose 3DES . Select NULL to set up a tunnel without encryption. When you select NULL , you do not enter any encryption keys.	DES
Key1	Enter a unique eight-character key. Any character may be used, including spaces, but trailing spaces are truncated. Fill in the Key1 field when you choose DES and fill in fields Key1 to Key3 when you choose 3DES .	89abcde
Key2	Enter a unique eight-character key. It can be comprised of any character including spaces (but trailing spaces are truncated).	
Key3	Enter a unique eight-character key. It can be comprised of any character including spaces (but trailing spaces are truncated).	
Authentication Algorithm	Press [SPACE BAR] to choose from MD5 or SHA1 and then press [ENTER].	MD5
Key	Enter the authentication key to be used by IPsec if applicable. The key must be unique. Enter 16 characters for MD5 authentication and 20 characters for SHA-1 authentication. Any character may be used, including spaces, but trailing spaces are truncated.	123456789a bcde
AH Setup	The AH Setup fields are N/A if you chose an ESP Active Protocol .	
SPI (Decimal)	The SPI must be from one to four unique decimal characters ("0" to "9") long.	N/A
Authentication Algorithm	Press [SPACE BAR] to choose from MD5 or SHA1 and then press [ENTER].	N/A
Key	Enter the authentication key to be used by IPsec if applicable. The key must be unique. Enter 16 characters for MD5 authentication and 20 characters for SHA-1 authentication. Any character may be used, including spaces, but trailing spaces are truncated.	N/A
When you have completed this menu, press [ENTER] at the prompt "Press ENTER to Confirm..." to save your configuration, or press [ESC] at any time to cancel.		

Chapter 41

SA Monitor

This chapter teaches you how to manage your SAs by using the SA Monitor in SMT menu 27.2.

41.1 Introduction

A Security Association (SA) is the group of security settings related to a specific VPN tunnel. This menu (shown next) displays active VPN connections.

When there is outbound traffic but no inbound traffic, the SA times out automatically after two minutes. A tunnel with no outbound or inbound traffic is "idle" and does not timeout until the SA lifetime period expires. See the web configurator parts of this *User's Guide on keep alive* to have the ZyWALL renegotiate an IPSec SA when the SA lifetime expires, even if there is no traffic.

41.2 Using SA Monitor

1. Use the **Refresh** function to display active VPN connections.
2. Use the **Disconnect** function to cut off active connections.

Type 2 in **Menu 27 - VPN/IPSec Setup**, and then press [ENTER] to go to **Menu 27.2 - SA Monitor**.

```

Menu 27.2 - SA Monitor

#           Name           Encap.       IPSec Algorithm
---          -             -             -
001      Taiwan : 3.3.3.1 - 3.3.3.3.100      Tunnel      ESP DES MD5
002
003
004
005
006
007
008
009
010

          Select Command= Refresh
          Select Connection= N/A

Press ENTER to Confirm or ESC to Cancel:

```

Figure 41-1 Menu 27.2: SA Monitor

Table 41-1 Menu 27.2: SA Monitor

FIELD	DESCRIPTION	EXAMPLE
#	This is the security association index number.	
Name	<p>This field displays the identification name for this VPN policy. This name is unique for each connection where the secure gateway IP address is a public static IP address.</p> <p>When the secure gateway IP address is 0.0.0.0 (as discussed in the last chapter), there may be different connections using this same VPN rule. In this case, the name is followed by the remote IP address as configured in Menu 27.1.1. – IPsec Setup. Individual connections using the same VPN rule may be terminated without affecting other connections using the same rule.</p>	Taiwan
Encap.	This field displays Tunnel mode or Transport mode. See previous for discussion.	Tunnel
IPSec Algorithm	<p>This field displays the security protocols used for an SA. ESP provides confidentiality and integrity of data by encrypting the data and encapsulating it into IP packets. Encryption methods include 56-bit DES, 168-bit 3DES and 128-bit AES. NULL denotes a tunnel without encryption.</p> <p>An incoming SA may have an AH in addition to ESP. The Authentication Header provides strong integrity and authentication by adding authentication information to IP packets. This authentication information is calculated using header and payload data in the IP packet. This provides an additional level of security. AH choices are MD5 (default - 128 bits) and SHA -1(160 bits).</p> <p>Both AH and ESP increase ZyWALL processing requirements and communications latency (delay).</p>	ESP DES MD5
Select Command	<p>Press [SPACE BAR] to choose from Refresh, Disconnect, None, Next Page, or Previous Page and then press [ENTER]. You must select a connection in the next field when you choose the Disconnect command. Refresh displays current active VPN connections. None allows you to jump to the “Press ENTER to Confirm...” prompt.</p> <p>Select Next Page or Previous Page to view the next or previous page of rules (respectively).</p>	Refresh
Select Connection	Type the VPN connection index number that you want to disconnect and then press [ENTER].	1
When you have completed this menu, press [ENTER] at the prompt “Press ENTER to Confirm...” to save your configuration, or press [ESC] at any time to cancel.		

Part XV:

Troubleshooting and Hardware Appendices

This part provides information about troubleshooting, hardware specifications, safety warnings and how to change a ZyWALL 100 fuse.

Appendix A

Troubleshooting

This chapter covers potential problems and possible remedies. After each problem description, some instructions are provided to help you to diagnose and to solve the problem. Please see our included disk for further information.

Problems Starting Up the ZyWALL

Chart A-1 Troubleshooting the Start-Up of Your ZyWALL

PROBLEM	CORRECTIVE ACTION	
None of the LEDs turn on when you turn on the ZyWALL.	Make sure that you have the included power adaptor or cord connected to the ZyWALL and to an appropriate power source.	
	Replace the fuse if it is burnt out (see the appendices for more on changing a fuse).	
	If the error persists, you may have a hardware problem. In this case, you should contact your vendor.	
Cannot access the ZyWALL via the console port.	1. Check to see if the ZyWALL is connected to your computer's console port.	
	2. Check to see if the communications program is configured correctly. The communications software should be configured as follows:	VT100 terminal emulation
		9600 bps is the default speed on leaving the factory. Try other speeds in case the speed has been changed.
No parity, 8 data bits, 1 stop bit, data flow set to none.		

Problems with the LAN Interface

Chart A-2 Troubleshooting the LAN Interface

PROBLEM	CORRECTIVE ACTION
Cannot access the ZyWALL from the LAN.	Check your Ethernet cable type and connections. Refer to the <i>Quick Start Guide</i> or <i>Compact Guide</i> for LAN connection instructions.
	Make sure the computer's Ethernet adapter is installed and functioning properly.
Cannot ping any computer on the LAN.	Check the 10M/100M LAN LEDs on the front panel. One of these LEDs should be on. If they are both off, check the cables between your ZyWALL and hub or the station.
	Verify that the IP address and the subnet mask of the ZyWALL and the computers are on the same subnet.

Problems with the DMZ Interface

The DMZ interface is not available on all models.

Chart A-3 Troubleshooting the DMZ Interface

PROBLEM	CORRECTIVE ACTION
Cannot access servers on the DMZ from the LAN.	Check your Ethernet cable type and connections. Refer to the <i>Quick Start Guide</i> or <i>Compact Guide</i> for DMZ connection instructions.
	Make sure the Ethernet adapters on the LAN computer and the DMZ server are installed and functioning properly.
	Verify that the IP address of the DMZ port and the LAN port are on separate subnets.
	Make sure that NAT is configured for your DMZ servers.
Cannot ping any computer on the DMZ.	Check the 10M/100M DMZ LEDs on the front panel. One of these LEDs should be on. If they are both off, check the cables between your ZyWALL and hub or the station.
	Verify that the IP address and the subnet mask of the ZyWALL and the servers are on the same subnet.

Problems with the WAN Interface

Chart A-4 Troubleshooting the WAN Interface

PROBLEM	CORRECTIVE ACTION
Cannot get WAN IP address from the ISP.	The ISP provides the WAN IP address after authentication. Authentication may be through the user name and password, the MAC address or the host name. Use the following corrective actions to make sure the ISP can authenticate your connection.
	You need a username and password if you're using PPPoE or PPTP encapsulation. Make sure that you have entered the correct Service Type , User Name and Password (the user name and password are case sensitive). Refer to the <i>WAN Screens</i> chapter (web configurator) or the <i>Internet Access</i> chapter (SMT).
	If your ISP requires MAC address authentication, you should clone the MAC address from your computer on the LAN as the ZyWALL's WAN MAC address. Refer to the <i>WAN Screens</i> chapter (web configurator) or the <i>WAN and Dial Backup Setup</i> chapter (SMT). It is recommended that you clone your computer's MAC address, even if your ISP presently does not require MAC address authentication.
	If your ISP requires host name authentication, configure your computer's name as the ZyWALL's system name. Refer to the <i>Wizard Setup</i> chapter (web configurator) or the <i>General Setup</i> chapter (SMT).

Problems with Internet Access

Chart A-5 Troubleshooting Internet Access

PROBLEM	CORRECTIVE ACTION
Cannot access the Internet.	Connect your cable/DSL modem with the ZyWALL using the appropriate cable. Check with the manufacturer of your cable/DSL device about your cable requirement because some devices may require crossover cable and others a regular straight-through cable.
	Refer to the <i>WAN Screens</i> chapter (web configurator) or the <i>Internet Access</i> chapter (SMT) and verify your settings.

Problems Accessing an Internet Web Site

Chart A-6 Troubleshooting Web Site Internet Access

PROBLEM	CORRECTIVE ACTION
Cannot connect to a web site on the Internet.	Disable content filtering and clear your browser cache.
	Try connecting to the web site again. If you can now connect to this site, then the content filter may have blocked original access. Check your content filter settings if this was not your intention.
	If you cannot connect to the site even after you disable content filtering, then please check your device connections and Internet access settings. Your username and password may be case-sensitive. If device connections and Internet access settings are correct, then please contact your Internet Service Provider.

Problems with the Password

Chart A-7 Troubleshooting the Password

PROBLEM	CORRECTIVE ACTION
Cannot access the ZyWALL.	The password field is case sensitive. Make sure that you enter the correct password using the proper casing.
	Use the Reset button to restore the factory default configuration file. This will restore all of the factory defaults including the password. See the <i>Resetting the ZyWALL</i> section in the <i>Introducing the Web Configurator</i> chapter for details.

Problems with Remote Management

Chart A-8 Troubleshooting Telnet

PROBLEM	CORRECTIVE ACTION
Cannot access the ZyWALL from the LAN or WAN.	Refer to the <i>Remote Management Limitations</i> section in the <i>Remote Management</i> chapter for scenarios when remote management may not be possible.
	When NAT is enabled: <ul style="list-style-type: none"> ➤ Use the ZyWALL's WAN IP address when configuring from the WAN. ➤ Use the ZyWALL's LAN IP address when configuring from the LAN.
	Refer to the <i>Problems with the LAN Interface</i> section for instructions on checking your LAN connection.
	Refer to the <i>Problems with the WAN Interface</i> section for instructions on checking your WAN connection.

Appendix B

Hardware Specifications

Chart B-1 General Specifications

Power Specification (ZyWALL 100)	100-240 VAC, 50/60Hz
Power Specification (ZyWALL 10W, 30W, 50)	I/P AC 120V / 60Hz; O/P DC 12V 1200 mA
Power Consumption (ZyWALL 100)	16 Watts maximum
Power Current (ZyWALL 100)	1.9 Amps
Fuse Rating (ZyWALL 100)	0.5 Amps, 250 VAC
MTBF	100000 hrs (Mean Time Between Failures)
Operation Temperature	0° C ~ 40° C
Ethernet Specification for WAN (Not on all models)	10/100Mbps Half / Full Auto-negotiation
Ethernet Specification for WAN (Not on all models)	10Mbps Half / Full Auto-negotiation
Ethernet Specification for DMZ (Not on all models)	10/100Mbps Half / Full Auto-negotiation
Ethernet Specification for LAN	10/100Mbps Half / Full Auto-negotiation

Cable Pin Assignments

In a serial communications connection, generally a computer is DTE (Data Terminal Equipment) and a modem is DCE (Data Circuit-terminating Equipment). The ZyWALL is DCE when you connect a computer to the console port. The ZyWALL is DTE when you connect a modem to the dial backup port.

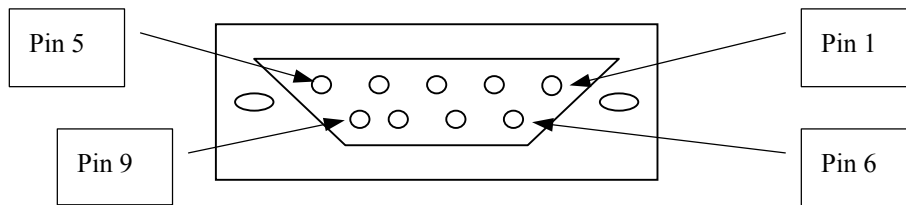

Diagram 1 Console/Dial Backup Port Pin Layouts ¹

Chart B-2 Console/Dial Backup Port Pin Assignments

CONSOLE Port RS – 232 (Female) DB-9F	DIAL BACKUP RS – 232 (Male) DB-9M (Not on all models)
Pin 1 = NON	Pin 1 = NON
Pin 2 = DCE-TXD	Pin 2 = DTE-RXD
Pin 3 = DCE –RXD	Pin 3 = DTE-TXD
Pin 4 = DCE –DSR	Pin 4 = DTE-DTR
Pin 5 = GND	Pin 5 = GND
Pin 6 = DCE –DTR	Pin 6 = DTE-DSR
Pin 7 = DCE –CTS	Pin 7 = DTE-RTS
Pin 8 = DCE –RTS	Pin 8 = DTE-CTS
PIN 9 = NON	PIN 9 = NON.
The CON/AUX port also has these pin assignments. The CON/AUX switch changes the setting in the firmware only and does not change the CON/AUX port's pin assignments.	ZyWALLs with a CON/AUX port also have a 9-pin adaptor for the console cable with these pin assignments on the male end.

¹ Pins 2,3 and 5 are used.

Chart B-3 Ethernet Cable Pin Assignments

WAN/LAN/DMZ Ethernet Cable Pin Layout:			
Straight-Through		Crossover	
(Switch)	(Adapter)	(Switch)	(Switch)
1 IRD +	1 OTD +	1 IRD +	1 IRD +
2 IRD -	2 OTD -	2 IRD -	2 IRD -
3 OTD +	3 IRD +	3 OTD +	3 OTD +
6 OTD -	6 IRD -	6 OTD -	6 OTD -

Power Adaptor Specifications (ZyWALL 10W/30W/50)

Chart B-4 North American AC Power Adaptor Specifications

AC Power Adapter model AD48-1201200DUY

Input power: AC120Volts/60Hz/0.25A

Output power: DC12Volts/1.2A

Power consumption: 10 W

Plug: North American standards

Safety standards: UL, CUL (UL 1950, CSA C22.2 No.234-M90)

AC Power Adapter model AD48-1201200DUY

Input power: AC120Volts/60Hz

Output power: DC12Volts/1.2A

Power consumption: 9 W

Plug: North American standards

Safety standards: UL, CUL (UL1950, CSA C22.2 NO. 234-M90)

Chart -B-5 European Union AC Power Adaptor Specifications

AC Power Adapter model AD-1201200DV

Input power: AC230Volts/50Hz/0.2A

Chart -B-5 European Union AC Power Adaptor Specifications

Output power: DC12Volts/1.2A

Power consumption: 10 W

Plug: European Union standards

Safety standards: TUV, CE (EN 60950)

AC Power Adapter model JAD-121200E

Input power: AC230Volts/50Hz,

Output power: DC12Volts/1.2A

Power consumption: 9 W

Plug: European Union standards

Safety standards: TUV, CE (EN 60950)

Chart B-6 UK AC Power Adaptor Specifications

AC Power Adapter model AD-1201200DK

Input power: AC230Volts/50Hz/0.2A

Output power: DC12Volts/1.2A

Power consumption: 10 W

Plug: United Kingdom standards

Safety standards: TUV, CE (EN 60950, BS7002)

Chart B-7 Japan AC Power Adaptor Specifications

AC Power Adapter model JOD-48-1124

Input power: AC100Volts/ 50/60Hz/ 27VA

Output power: DC12Volts/1.2A

Power consumption: 10 W

Plug: Japan standards

Safety standards: T-Mark

Chart B-8 Australia and New Zealand AC Power Adaptor Specifications

AC Power Adapter model AD-1201200Ds or AD-121200DS

Input power: AC240Volts/50Hz/0.2A

Output power: DC12Volts/1.2A

Power consumption: 10 W

Plug: Australia and New Zealand standards

Safety standards: NATA (AS 3260)

Appendix C

Safety Warnings and Instructions

1. Be sure to read and follow all warning notices and instructions.
2. The maximum recommended ambient temperature for the ZyWALL is 40° Celsius (104° Fahrenheit). Care must be taken to allow sufficient air circulation or space between units when the ZyWALL is installed inside a closed rack assembly. The operating ambient temperature of the rack environment might be greater than room temperature.
3. Installation in a rack without sufficient airflow can be unsafe.
4. Racks should safely support the combined weight of all equipment.
5. The connections and equipment that supply power to the ZyWALL should be capable of operating safely with the maximum power requirements of the ZyWALL. In case of a power overload, the supply circuits and supply wiring should not become hazardous. The input rating of the ZyWALL is printed on the nameplate.
6. The power cord or power adaptor must plug in to the right supply voltage, i.e. 110VAC for North America and 230VAC for Europe. Make sure that the supplied AC voltage is correct and stable.
7. Installation in restricted access areas must comply with Articles 110-16, 110-17, and 110-18 of the National Electrical Code, ANSI/NFPA 70.
8. Do not allow anything to rest on the power cord and do not locate the product where anyone can walk on the power cord.
9. Do not service the product by yourself. Opening or removing covers can expose you to dangerous high voltage points or other risks. Refer all servicing to qualified service personnel.
10. Generally, when installed after the final configuration, the product must comply with the applicable safety standards and regulatory requirements of the country in which it is installed. If necessary, consult the appropriate regulatory agencies and inspection authorities to ensure compliance.
11. A rare condition can create a voltage potential between the earth grounds of two or more buildings. If products installed in separate building are interconnected, the voltage potential can cause a hazardous condition. Consult a qualified electrical consultant to determine whether or not this phenomenon exists and, if necessary, implement corrective action before interconnecting the products.

Appendix D

Removing and Installing a ZyWALL 100 Fuse

This appendix shows you how to remove and install fuses for the ZyWALL 100.

The ZyWALL 100 uses a 0.5 Amp, 250 VAC fuse. The ZyWALL-100 comes from the factory; with two fuses installed in the fuse housing. If you need to install a new fuse, follow the procedure below.

Removing a Fuse

Disconnect all power from the ZyWALL 100 before you begin this procedure.

- Step 1.** Place the rear panel of the ZyWALL 100 in front of you.
- Step 2.** Remove the power cord from the back of the unit.
- Step 3.** The fuse housing is located between the power switch and the power port. Use a small flat-head screwdriver to carefully pry out the fuse housing.
- Step 4.** A burnt-out fuse is blackened, darkened or cloudy inside its glass casing. A working fuse has a completely clear glass casing. Pull gently, but firmly, to remove the burnt out fuse from the fuse housing. Dispose of the burnt-out fuse.

Installing a Fuse

- Step 1.** The ZyWALL 100 is shipped from the factory with one spare fuse included in a box-like section of the fuse housing. Push the middle part of the box-like section to access the spare fuse. Put another spare fuse in its place in order to always have one on hand.
- Step 2.** Push the replacement fuse into the fuse housing until you hear a click.
- Step 3.** Firmly, but gently, push the fuse housing back into the ZyWALL 100 until you hear a click.
- Step 4.** Plug the power cord back into the unit.

Part XVI:

General Appendices

This part provides background information about setting up your computer's IP address, triangle route, how functions are related, wireless LAN, 802.1x, EAP authentication, PPPoE, PPTP and IP subnetting.

Appendix E

Setting up Your Computer's IP Address

All computers must have a 10M or 100M Ethernet adapter card and TCP/IP installed.

Windows 95/98/Me/NT/2000/XP, Macintosh OS 7 and later operating systems and all versions of UNIX/LINUX include the software components you need to install and use TCP/IP on your computer. Windows 3.1 requires the purchase of a third-party TCP/IP application package.

TCP/IP should already be installed on computers using Windows NT/2000/XP, Macintosh OS 7 and later operating systems.

After the appropriate TCP/IP components are installed, configure the TCP/IP settings in order to "communicate" with your network.

If you manually assign IP information instead of using dynamic assignment, make sure that your computers have IP addresses that place them in the same subnet as the ZyWALL's LAN port.

Windows 95/98/Me

Click **Start**, **Settings**, **Control Panel** and double-click the **Network** icon to open the **Network** window.

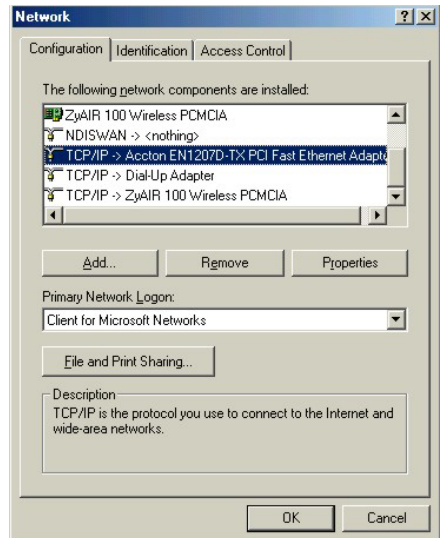

The **Network** window **Configuration** tab displays a list of installed components. You need a network adapter, the TCP/IP protocol and Client for Microsoft Networks.

If you need the adapter:

- a. In the **Network** window, click **Add**.
- b. Select **Adapter** and then click **Add**.
- c. Select the manufacturer and model of your network adapter and then click **OK**.

If you need TCP/IP:

- a. In the **Network** window, click **Add**.
- b. Select **Protocol** and then click **Add**.
- c. Select **Microsoft** from the list of **manufacturers**.
- d. Select **TCP/IP** from the list of network protocols and then click **OK**.

If you need Client for Microsoft Networks:

- a. Click **Add**.
- b. Select **Client** and then click **Add**.
- c. Select **Microsoft** from the list of manufacturers.
- d. Select **Client for Microsoft Networks** from the list of network clients and then click **OK**.
- e. Restart your computer so the changes you made take effect.

In the **Network** window **Configuration** tab, select your network adapter's TCP/IP entry and click **Properties**.

1. Click the **IP Address** tab.
 - If your IP address is dynamic, select **Obtain an IP address automatically**.
 - If you have a static IP address, select **Specify an IP address** and type your information into the **IP Address** and **Subnet Mask** fields.

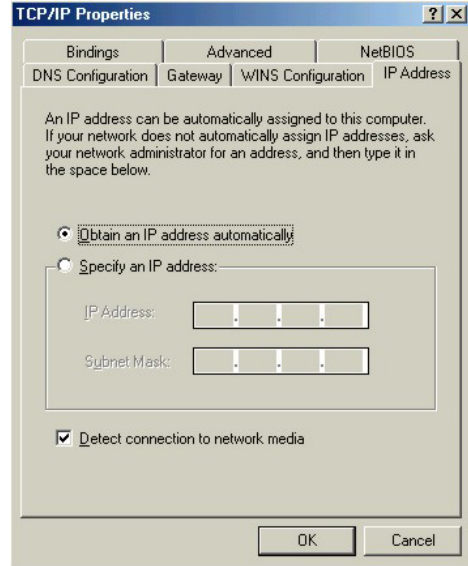

2. Click the **DNS Configuration** tab.
 - If you do not know your DNS information, select **Disable DNS**.
 - If you know your DNS information, select **Enable DNS** and type the information in the fields below (you may not need to fill them all in).

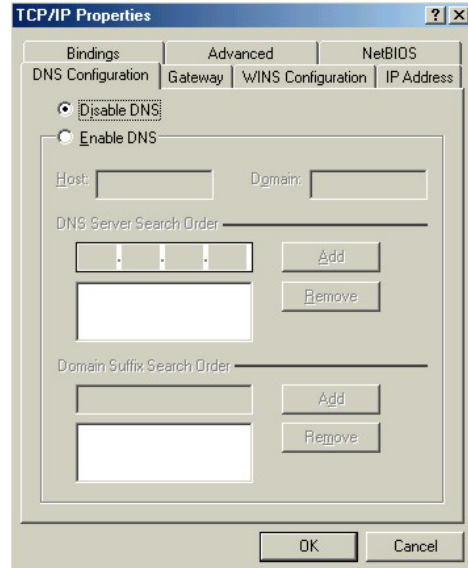

3. Click the **Gateway** tab.
 - If you do not know your gateway's IP address, remove previously installed gateways.
 - If you have a gateway IP address, type it in the **New gateway field** and click **Add**.

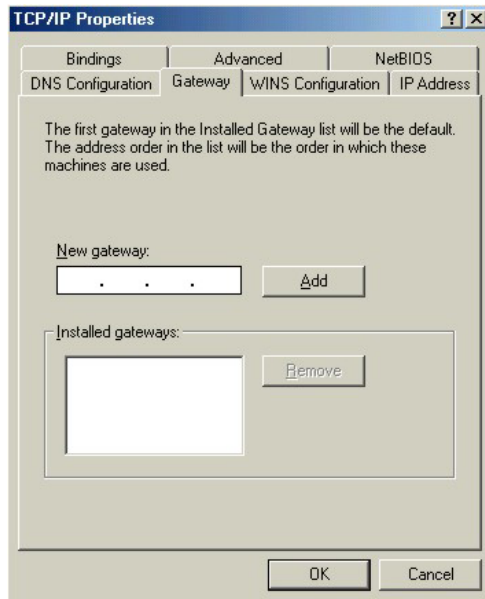

4. Click **OK** to save and close the **TCP/IP Properties** window.
5. Click **OK** to close the **Network** window. Insert the Windows CD if prompted.
6. Turn on your ZyWALL and restart your computer when prompted.

Verifying Your Computer's IP Address

1. Click **Start** and then **Run**.
2. In the **Run** window, type "winipcfg" and then click **OK** to open the **IP Configuration** window.
3. Select your network adapter. You should see your computer's IP address, subnet mask and default gateway.

Windows 2000/NT/XP

1. For Windows XP, click **start, Control Panel**. In Windows 2000/NT, click **Start, Settings, Control Panel**.



2. For Windows XP, click **Network Connections**. For Windows 2000/NT, click **Network and Dial-up Connections**.



3. Right-click **Local Area Connection** and then click **Properties**.

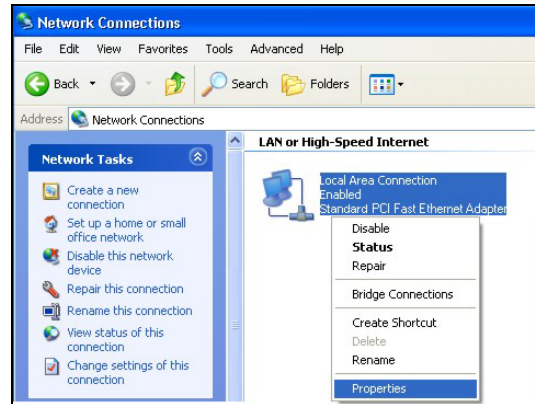

4. Select **Internet Protocol (TCP/IP)** (under the **General** tab in Win XP) and click **Properties**.

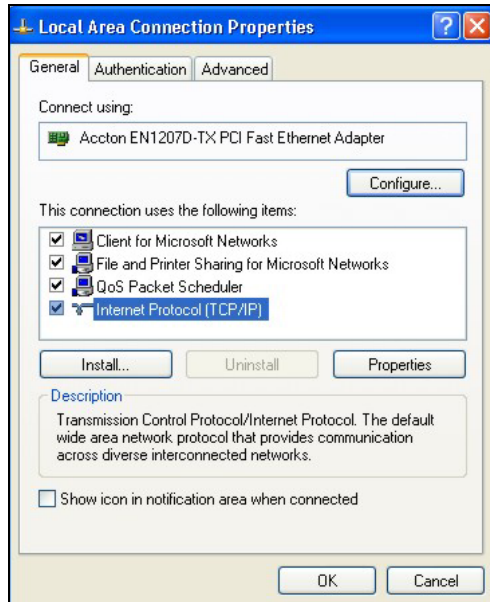

5. The **Internet Protocol TCP/IP Properties** window opens (the **General** tab in Windows XP).

-If you have a dynamic IP address click **Obtain an IP address automatically**.

-If you have a static IP address click **Use the following IP Address** and fill in the **IP address**, **Subnet mask**, and **Default gateway** fields.

Click **Advanced**.

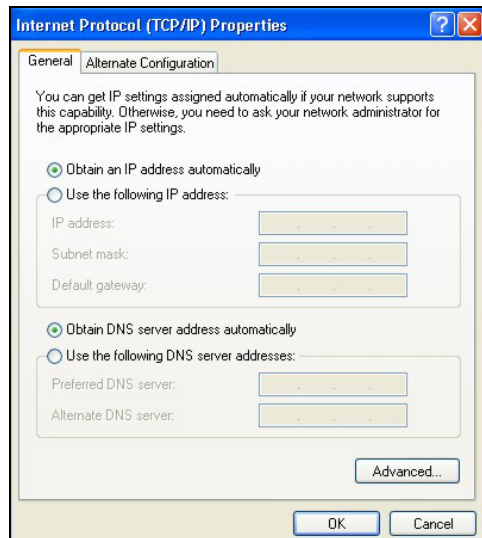

6. -If you do not know your gateway's IP address, remove any previously installed gateways in the **IP Settings** tab and click **OK**.

Do one or more of the following if you want to configure additional IP addresses:

-In the **IP Settings** tab, in IP addresses, click **Add**.

-In **TCP/IP Address**, type an IP address in **IP address** and a subnet mask in **Subnet mask**, and then click **Add**.

-Repeat the above two steps for each IP address you want to add.

-Configure additional default gateways in the **IP Settings** tab by clicking **Add** in **Default gateways**.

-In **TCP/IP Gateway Address**, type the IP address of the default gateway in **Gateway**. To manually configure a default metric (the number of transmission hops), clear the **Automatic metric** check box and type a metric in **Metric**.

-Click **Add**.

-Repeat the previous three steps for each default gateway you want to add.

-Click **OK** when finished.

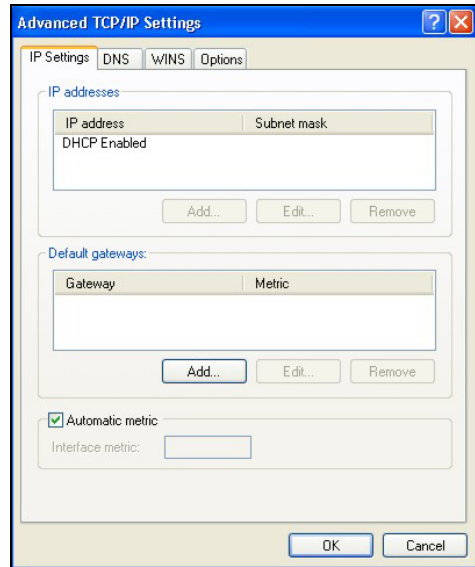

7. In the **Internet Protocol TCP/IP Properties** window (the **General tab** in Windows XP):

-Click **Obtain DNS server address automatically** if you do not know your DNS server IP address(es).

-If you know your DNS server IP address(es), click **Use the following DNS server addresses**, and type them in the **Preferred DNS server** and **Alternate DNS server** fields.

If you have previously configured DNS servers, click **Advanced** and then the **DNS** tab to order them.

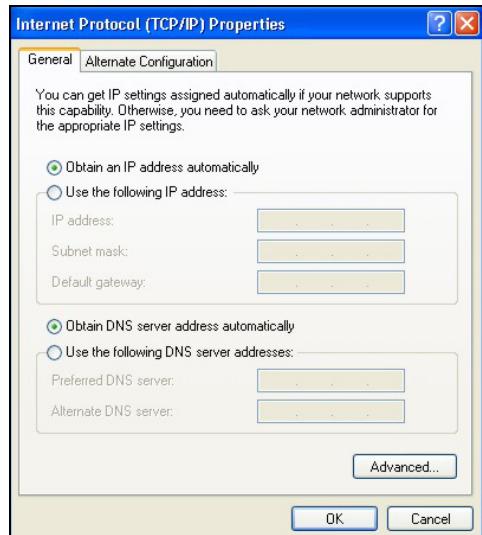

8. Click **OK** to close the **Internet Protocol (TCP/IP) Properties** window.
9. Click **OK** to close the **Local Area Connection Properties** window.
10. Turn on your ZyWALL and restart your computer (if prompted).

Verifying Your Computer's IP Address

1. Click **Start, All Programs, Accessories** and then **Command Prompt**.
2. In the **Command Prompt** window, type "ipconfig" and then press [ENTER]. You can also open **Network Connections**, right-click a network connection, click **Status** and then click the **Support** tab.

Macintosh OS 8/9

1. Click the **Apple** menu, **Control Panel** and double-click **TCP/IP** to open the **TCP/IP Control Panel**.

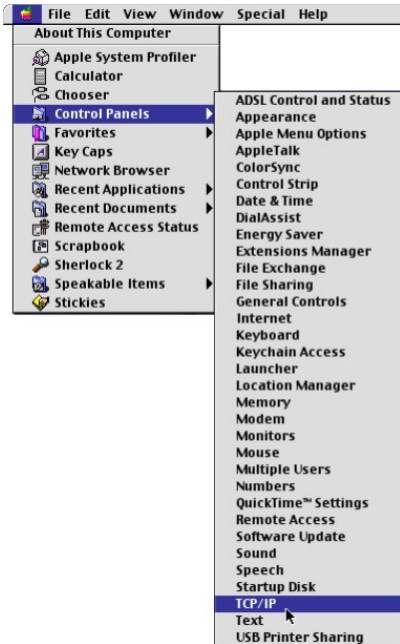

2. Select **Ethernet built-in** from the **Connect via** list.

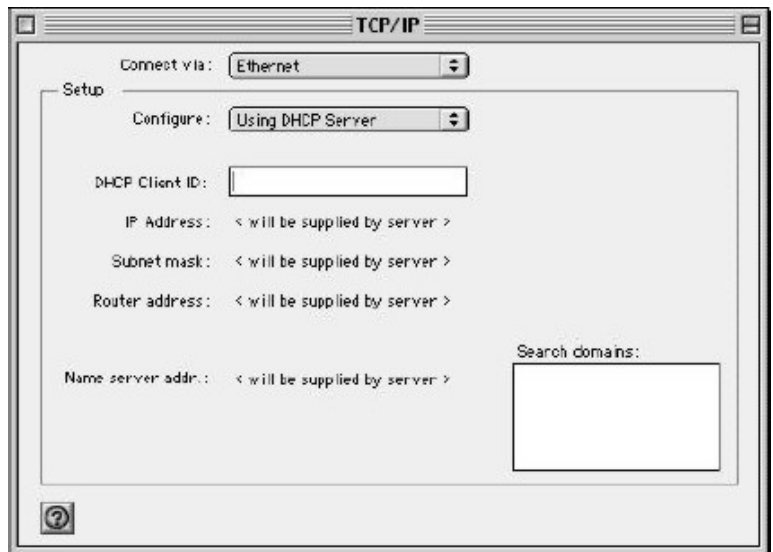

3. For dynamically assigned settings, select **Using DHCP Server** from the **Configure:** list.

4. For statically assigned settings, do the following:
 - From the **Configure** box, select **Manually**.
 - Type your IP address in the **IP Address** box.
 - Type your subnet mask in the **Subnet mask** box.
 - Type the IP address of your ZyWALL in the **Router address** box.
5. Close the **TCP/IP Control Panel**.
6. Click **Save** if prompted, to save changes to your configuration.
7. Turn on your ZyWALL and restart your computer (if prompted).

Verifying Your Computer's IP Address

Check your TCP/IP properties in the **TCP/IP Control Panel** window.

Macintosh OS X

1. Click the **Apple** menu, and click **System Preferences** to open the **System Preferences** window.

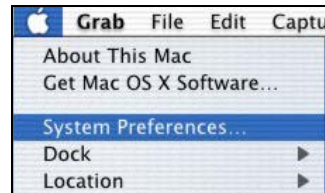

2. Click **Network** in the icon bar.
 - Select **Automatic** from the **Location** list.
 - Select **Built-in Ethernet** from the **Show** list.
 - Click the **TCP/IP** tab.

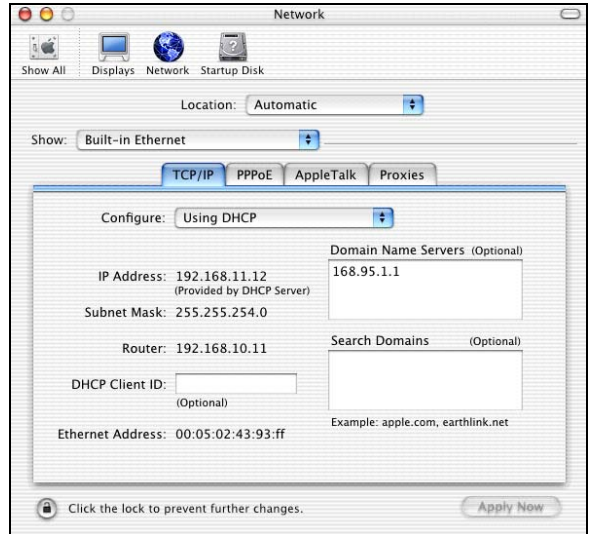

3. For dynamically assigned settings, select **Using DHCP** from the **Configure** list.
4. For statically assigned settings, do the following:
 - From the **Configure** box, select **Manually**.
 - Type your IP address in the **IP Address** box.
 - Type your subnet mask in the **Subnet mask** box.
 - Type the IP address of your ZyWALL in the **Router address** box.
5. Click **Apply Now** and close the window.
6. Turn on your ZyWALL and restart your computer (if prompted).

Verifying Your Computer's IP Address

Check your TCP/IP properties in the **Network** window.

Appendix F

Triangle Route

The Ideal Setup

When the firewall is on, your ZyWALL acts as a secure gateway between your LAN and the Internet. In an ideal network topology, all incoming and outgoing network traffic passes through the ZyWALL to protect your LAN against attacks. SYN traffic (1 in the figure) is replied to by SYN/ACK traffic (2 in the figure).

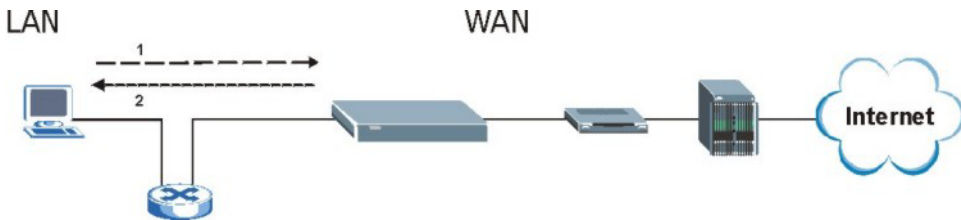

Diagram F-1 Ideal Setup

The “Triangle Route” Problem

A traffic route is a path for sending or receiving data packets between two Ethernet devices. Some companies have more than one alternate route to one or more ISPs. If the LAN and ISP(s) are in the same subnet, the “triangle route” problem may occur. The steps below describe the “triangle route” problem.

1. A computer on the LAN initiates a connection by sending out a SYN packet (A) to a receiving server on the WAN.
2. The ZyWALL reroutes the SYN packet through Gateway B on the LAN to the WAN.
3. The reply from the WAN goes directly to the computer on the LAN without going through the ZyWALL.

As a result, the ZyWALL resets the connection, as the connection has not been acknowledged.

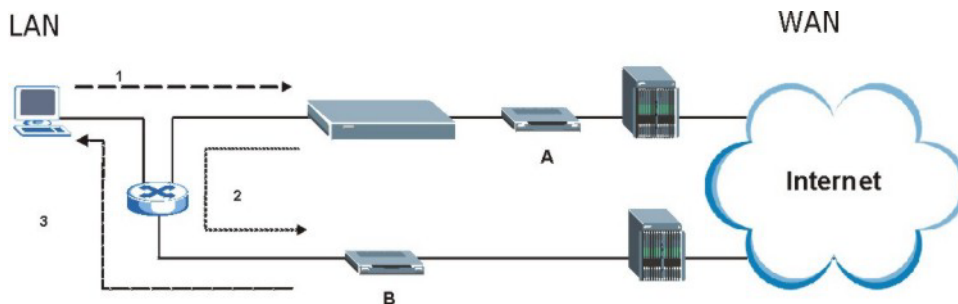

Diagram F-2 “Triangle Route” Problem

The “Triangle Route” Solutions

This section presents you two solutions to the “triangle route” problem.

IP Aliasing

IP alias allows you to partition your network into logical sections over the same Ethernet interface. Your ZyWALL supports up to three logical LAN interfaces with the ZyWALL being the gateway for each logical network. By putting your LAN and Gateway **B** in different subnets, all returning network traffic must pass through the ZyWALL to your LAN. The following steps describe such a scenario.

1. A computer on the LAN initiates a connection by sending a SYN packet to a receiving server on the WAN.
2. The ZyWALL reroutes the packet to Gateway **B** in Subnet 2.
3. The reply from WAN goes through the ZyWALL to the computer on the LAN in Subnet 1.

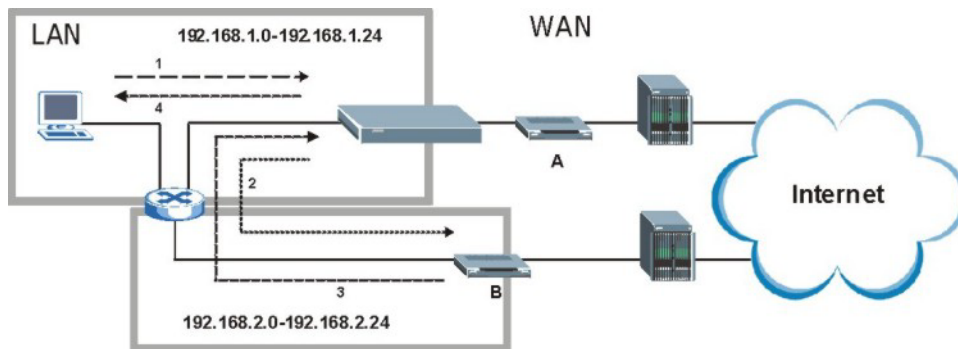

Diagram F-3 IP Alias

Gateways on the WAN Side

A second solution to the “triangle route” problem is to put all of your network gateways on the WAN side as the following figure shows. This ensures that all incoming network traffic passes through your ZyWALL to your LAN. Therefore your LAN is protected.

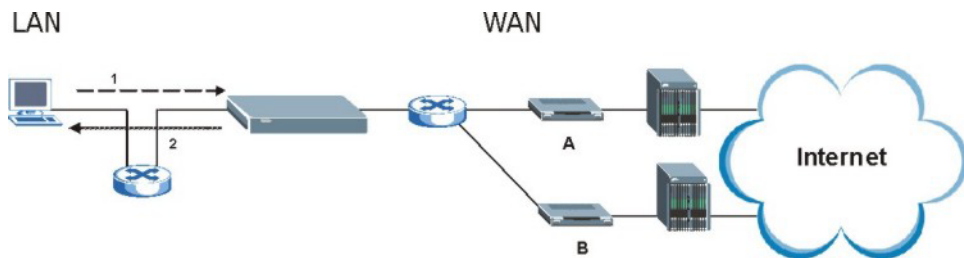

Diagram F-4 Gateways on the WAN Side

Appendix G

The Big Picture

The following figure gives an overview of how filtering, the firewall, VPN and NAT are related.

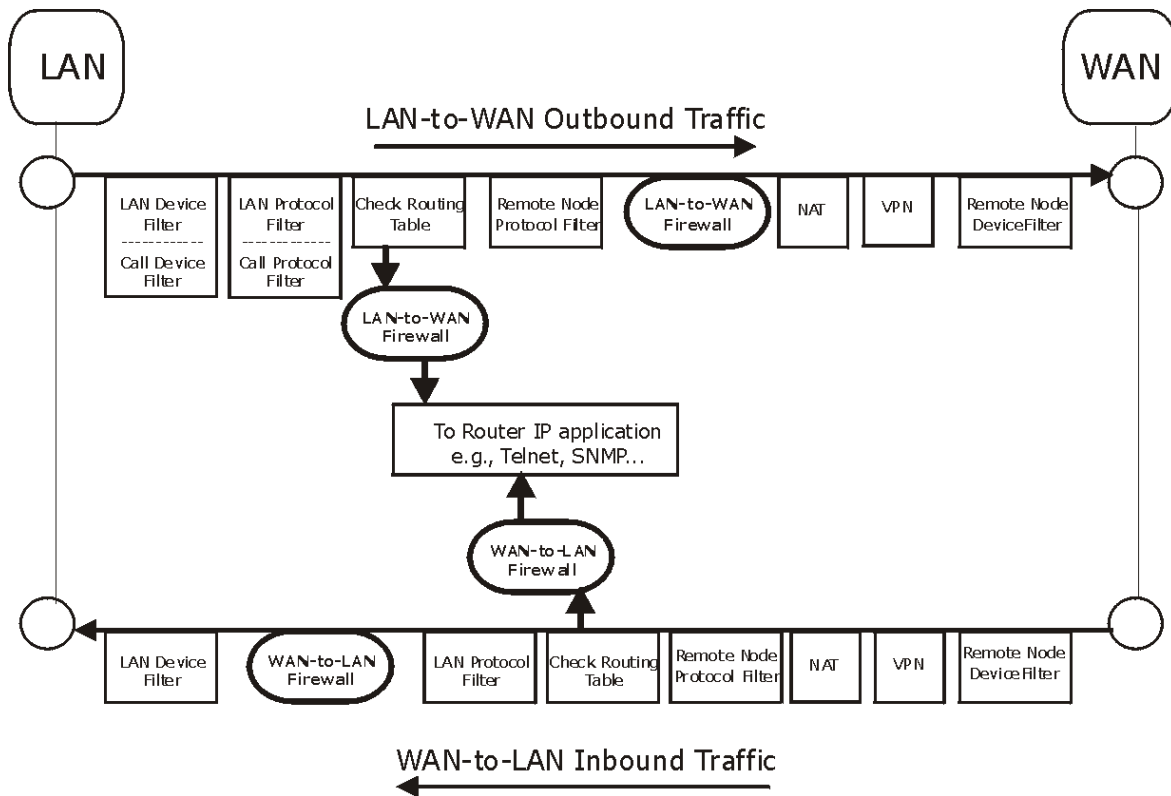

Diagram G-1 Big Picture— Filtering, Firewall, VPN and NAT

Appendix H

Wireless LAN and IEEE 802.11

A wireless LAN (WLAN) provides a flexible data communications system that you can use to access various services (navigating the Internet, email, printer services, etc.) without the use of a cabled connection. In effect a wireless LAN environment provides you the freedom to stay connected to the network while roaming around in the coverage area. WLAN is not available on all models.

Benefits of a Wireless LAN

Wireless LAN offers the following benefits:

1. It provides you with access to network services in areas otherwise hard or expensive to wire, such as historical buildings, buildings with asbestos materials and classrooms.
2. It provides healthcare workers like doctors and nurses access to a complete patient's profile on a handheld or notebook computer upon entering a patient's room.
3. It allows flexible workgroups a lower total cost of ownership for workspaces that are frequently reconfigured.
4. It allows conference room users access to the network as they move from meeting to meeting, getting up-to-date access to information and the ability to communicate decisions while "on the go".
5. It provides campus-wide networking mobility, allowing enterprises the roaming capability to set up easy-to-use wireless networks that cover the entire campus transparently.

IEEE 802.11

The 1997 completion of the IEEE 802.11 standard for wireless LANs (WLANs) was a first important step in the evolutionary development of wireless networking technologies. The standard was developed to maximize interoperability between differing brands of wireless LANs as well as to introduce a variety of performance improvements and benefits.

The IEEE 802.11 specifies three different transmission methods for the PHY, the layer responsible for transferring data between nodes. Two of the methods use spread spectrum RF signals, Direct Sequence Spread Spectrum (DSSS) and Frequency-Hopping Spread Spectrum (FHSS), in the 2.4 to 2.4825 GHz unlicensed ISM (Industrial, Scientific and Medical) band. The third method is infrared technology, using very high frequencies, just below visible light in the electromagnetic spectrum to carry data.

Ad-hoc Wireless LAN Configuration

The simplest WLAN configuration is an independent (Ad-hoc) WLAN that connects a set of computers with wireless nodes or stations (STA), which is called a Basic Service Set (BSS). In the most basic form, a wireless LAN connects a set of computers with wireless adapters. Any time two or more wireless adapters are within range of each other, they can set up an independent network, which is commonly referred to as an Ad-hoc network or Independent Basic Service Set (IBSS). The following diagram shows an example of desktop and notebook computers using wireless adapters to form an Ad-hoc wireless LAN.



Diagram H-1 Peer-to-Peer Communication in an Ad-hoc Network

Infrastructure Wireless LAN Configuration

For Infrastructure WLANs, multiple Access Points (APs) link the WLAN to the wired network and allow users to efficiently share network resources. The Access Points not only provide communication with the wired network but also mediate wireless network traffic in the immediate neighborhood. Multiple Access

Points can provide wireless coverage for an entire building or campus. All communications between stations or between a station and a wired network client go through the Access Point.

The Extended Service Set (ESS) shown in the next figure consists of a series of overlapping BSSs (each containing an Access Point) connected together by means of a Distribution System (DS). Although the DS could be any type of network, it is almost invariably an Ethernet LAN. Mobile nodes can roam between Access Points and seamless campus-wide coverage is possible.

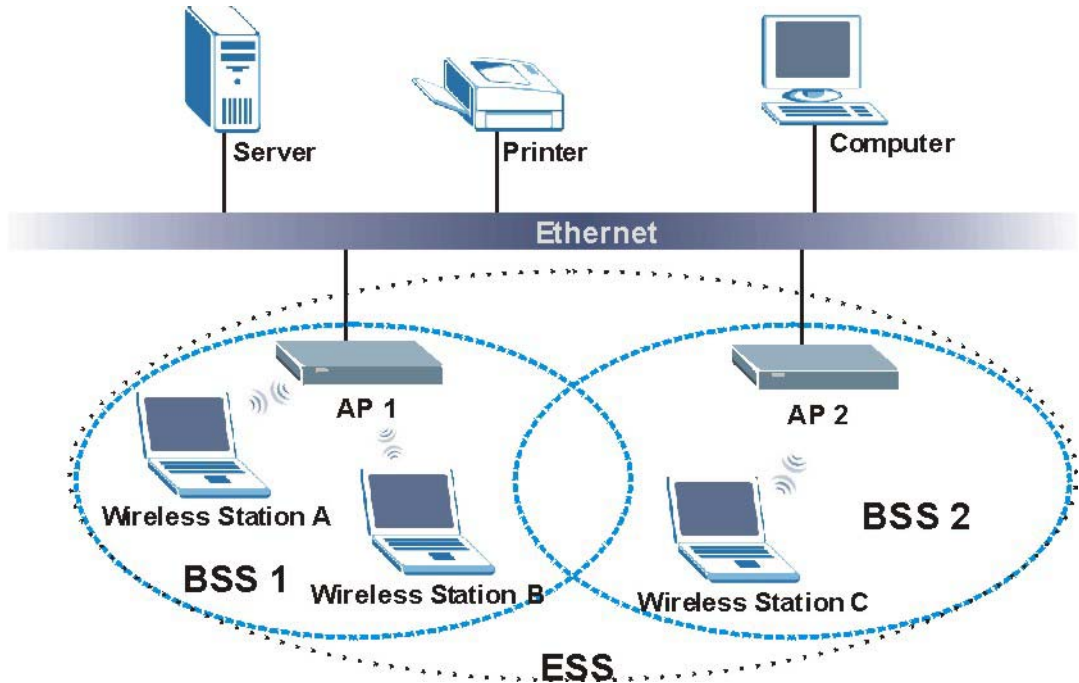

Diagram H-2 ESS Provides Campus-Wide Coverage

Appendix I

Wireless LAN With IEEE 802.1x

As wireless networks become popular for both portable computing and corporate networks, security is now a priority.

Security Flaws with IEEE 802.11

Wireless networks based on the original IEEE 802.11 have a poor reputation for safety. The IEEE 802.11b wireless access standard, first published in 1999, was based on the MAC address. As the MAC address is sent across the wireless link in clear text, it is easy to spoof and fake. Even the WEP (Wire Equivalent Privacy) data encryption is unreliable as it can be easily decrypted with current computer speed

Deployment Issues with IEEE 802.11

User account management has become a network administrator's nightmare in a corporate environment, as the IEEE 802.11b standard does not provide any central user account management. User access control is done through manual modification of the MAC address table on the access point. Although WEP data encryption offers a form of data security, you have to reset the WEP key on the clients each time you change your WEP key on the access point.

IEEE 802.1x

In June 2001, the IEEE 802.1x standard was designed to extend the features of IEEE 802.11 to support extended authentication as well as providing additional accounting and control features. It is supported by Windows XP and a number of network devices.

Advantages of the IEEE 802.1x

- User based identification that allows for roaming.

- Support for RADIUS (Remote Authentication Dial In User Service, RFC 2138, 2139) for centralized user profile and accounting management on a network RADIUS server.
- Support for EAP (Extensible Authentication Protocol, RFC 2486) that allows additional authentication methods to be deployed with no changes to the access point or the wireless clients.

RADIUS Server Authentication Sequence

The following figure depicts a typical wireless network with a remote RADIUS server for user authentication using EAPOL (EAP Over LAN).

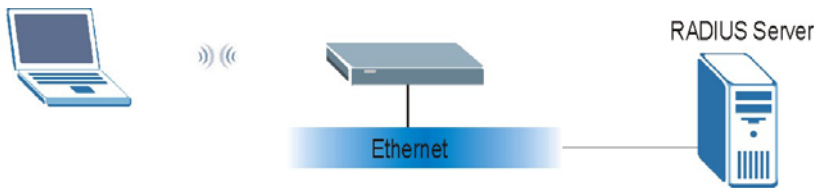

Unauthorized State

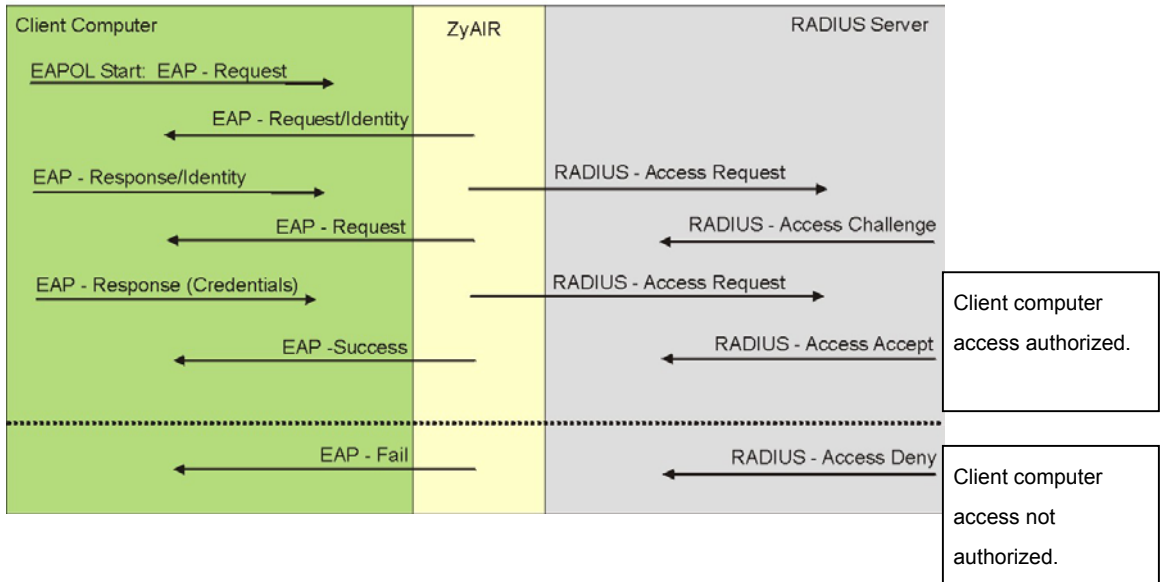

Diagram I-1 Sequences for EAP MD5–Challenge Authentication

Appendix J

Types of EAP Authentication

This appendix discusses three popular EAP authentication types: **EAP-MD5**, **EAP-TLS** and **EAP-TTLS**. The type of authentication you use depends on the RADIUS server or the AP. Consult your network administrator for more information.

EAP-MD5 (Message-Digest Algorithm 5)

MD5 authentication is the simplest one-way authentication method. The authentication server sends a challenge to the wireless station. The wireless station ‘proves’ that it knows the password by encrypting the password with the challenge and sends back the information. Password is not sent in plain text.

However, MD5 authentication has some weaknesses. Since the authentication server needs to get the plaintext passwords, the passwords must be stored. Thus someone other than the authentication server may access the password file. In addition, it is possible to impersonate an authentication server as MD5 authentication method does not perform mutual authentication. Finally, MD5 authentication method does not support data encryption with dynamic session key. You must configure WEP encryption keys for data encryption.

EAP-TLS (Transport Layer Security)

With EAP-TLS, digital certifications are needed by both the server and the wireless stations for mutual authentication. The server presents a certificate to the client. After validating the identity of the server, the client sends a different certificate to the server. The exchange of certificates is done in the open before a secured tunnel is created. This makes user identity vulnerable to passive attacks. A digital certificate is an electronic ID card that authenticates the sender’s identity. However, to implement EAP-TLS, you need a Certificate Authority (CA) to handle certificates, which imposes a management overhead.

EAP-TTLS (Tunneled Transport Layer Service)

EAP-TTLS is an extension of the EAP-TLS authentication that uses certificates for only the server-side authentications to establish a secure connection. Client authentication is then done by sending username and password through the secure connection, thus client identity is protected. For client authentication, EAP-TTLS supports EAP methods and legacy authentication methods such as PAP, CHAP, MS-CHAP and MS-CHAP v2.

	EAP-MD5	EAP-TLS	EAP-TTLS
Mutual Authentication	No	Yes	Yes
Certificate – Client	No	Yes	Optional
Certificate – Server	No	Yes	Yes
Dynamic Key Exchange	No	Yes	Yes
Credential Security	None	Strong	Strong
Deployment Difficulty	Easy	Hard	Moderate
Wireless Security	Poor	Best	Good
Client Identity Protection	No	No	Yes

Appendix K

PPPoE

PPPoE in Action

An ADSL modem bridges a PPP session over Ethernet (PPP over Ethernet, RFC 2516) from your PC to an ATM PVC (Permanent Virtual Circuit), which connects to a DSL Access Concentrator where the PPP session terminates (see the next figure). One PVC can support any number of PPP sessions from your LAN. PPPoE provides access control and billing functionality in a manner similar to dial-up services using PPP.

Benefits of PPPoE

PPPoE offers the following benefits:

1. It provides you with a familiar dial-up networking (DUN) user interface.
2. It lessens the burden on the carriers of provisioning virtual circuits all the way to the ISP on multiple switches for thousands of users. For GSTN (PSTN & ISDN), the switching fabric is already in place.
3. It allows the ISP to use the existing dial-up model to authenticate and (optionally) to provide differentiated services.

Traditional Dial-up Scenario

The following diagram depicts a typical hardware configuration where the PCs use traditional dial-up networking.

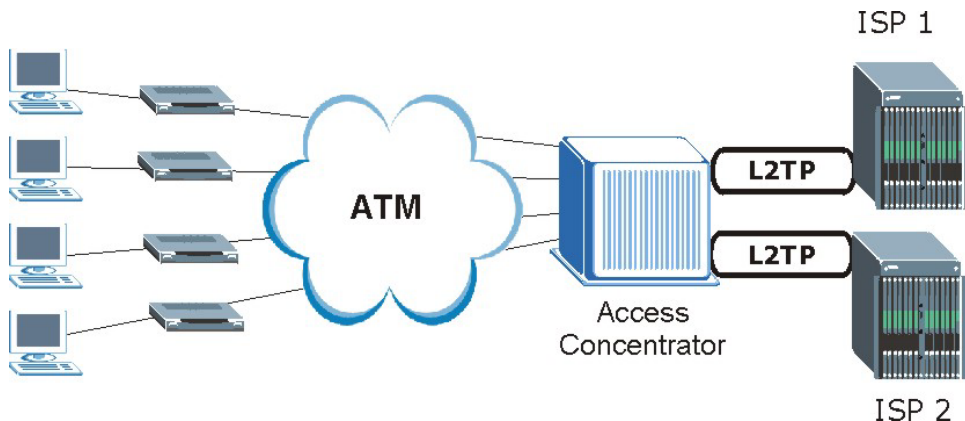

Diagram K-1 Single-PC per Modem Hardware Configuration

How PPPoE Works

The PPPoE driver makes the Ethernet appear as a serial link to the PC and the PC runs PPP over it, while the modem bridges the Ethernet frames to the Access Concentrator (AC). Between the AC and an ISP, the AC is acting as a L2TP (Layer 2 Tunneling Protocol) LAC (L2TP Access Concentrator) and tunnels the PPP frames to the ISP. The L2TP tunnel is capable of carrying multiple PPP sessions.

With PPPoE, the VC (Virtual Circuit) is equivalent to the dial-up connection and is between the modem and the AC, as opposed to all the way to the ISP. However, the PPP negotiation is between the PC and the ISP.

ZyWALL as a PPPoE Client

When using the ZyWALL as a PPPoE client, the PCs on the LAN see only Ethernet and are not aware of PPPoE. This alleviates the administrator from having to manage the PPPoE clients on the individual PCs.

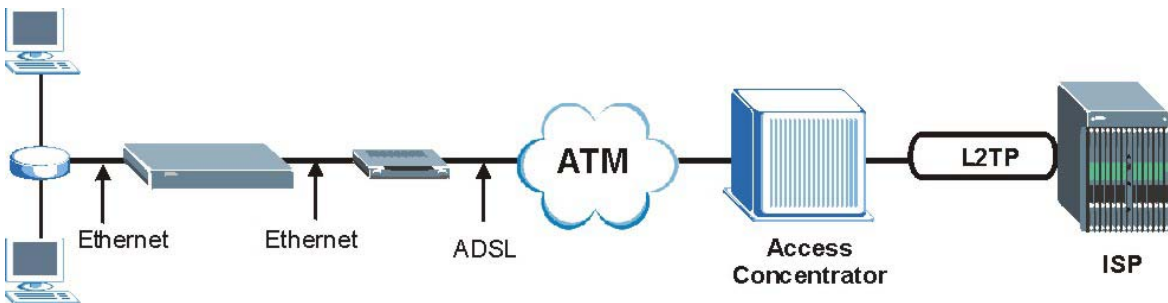

Diagram K-2 ZyWALL as a PPPoE Client

Appendix L

PPTP

What is PPTP?

PPTP (Point-to-Point Tunneling Protocol) is a Microsoft proprietary protocol (RFC 2637 for PPTP is informational only) to tunnel PPP frames.

How can we transport PPP frames from a PC to a broadband modem over Ethernet?

A solution is to build PPTP into the ANT (ADSL Network Termination) where PPTP is used only over the short haul between the PC and the modem over Ethernet. For the rest of the connection, the PPP frames are transported with PPP over AAL5 (RFC 2364). The PPP connection, however, is still between the PC and the ISP. The various connections in this setup are depicted in the following diagram. The drawback of this solution is that it requires one separate ATM VC per destination.

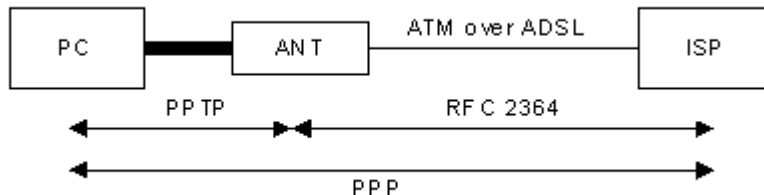

Diagram L-1 Transport PPP frames over Ethernet

PPTP and the ZyWALL

When the ZyWALL is deployed in such a setup, it appears as a PC to the ANT.

In Windows VPN or PPTP Pass-Through feature, the PPTP tunneling is created from Windows 95, 98 and NT clients to an NT server in a remote location. The pass-through feature allows users on the network to access a different remote server using the ZyWALL's Internet connection. In NAT mode, the ZyWALL is able to pass the PPTP packets to the internal PPTP server (i.e. NT server) behind the NAT. Users need to forward PPTP packets to port 1723 by configuring the server in **Menu 15.2 - Server Set Setup**. In the case above as the remote PPTP Client initializes the PPTP connection, the user must configure the PPTP clients. The ZyWALL initializes the PPTP connection hence; there is no need to configure the remote PPTP clients.

PPTP Protocol Overview

PPTP is very similar to L2TP, since L2TP is based on both PPTP and L2F (Cisco's Layer 2 Forwarding). Conceptually, there are three parties in PPTP, namely the PNS (PPTP Network Server), the PAC (PPTP Access Concentrator) and the PPTP user. The PNS is the box that hosts both the PPP and the PPTP stacks and forms one end of the PPTP tunnel. The PAC is the box that dials/answers the phone calls and relays the PPP frames to the PNS. The PPTP user is not necessarily a PPP client (can be a PPP server too). Both the PNS and the PAC must have IP connectivity; however, the PAC must in addition have dial-up capability. The phone call is between the user and the PAC and the PAC tunnels the PPP frames to the PNS. The PPTP user is unaware of the tunnel between the PAC and the PNS.



Diagram L-2 PPTP Protocol Overview

Microsoft includes PPTP as a part of the Windows OS. In Microsoft's implementation, the PC, and hence the ZyWALL, is the PNS that requests the PAC (the ANT) to place an outgoing call over AAL5 to an RFC 2364 server.

Control & PPP connections

Each PPTP session has distinct control connection and PPP data connection.

Call Connection

The control connection runs over TCP. Similar to L2TP, a tunnel control connection is first established before call control messages can be exchanged. Please note that a tunnel control connection supports multiple call sessions.

The following diagram depicts the message exchange of a successful call setup between a PC and an ANT.

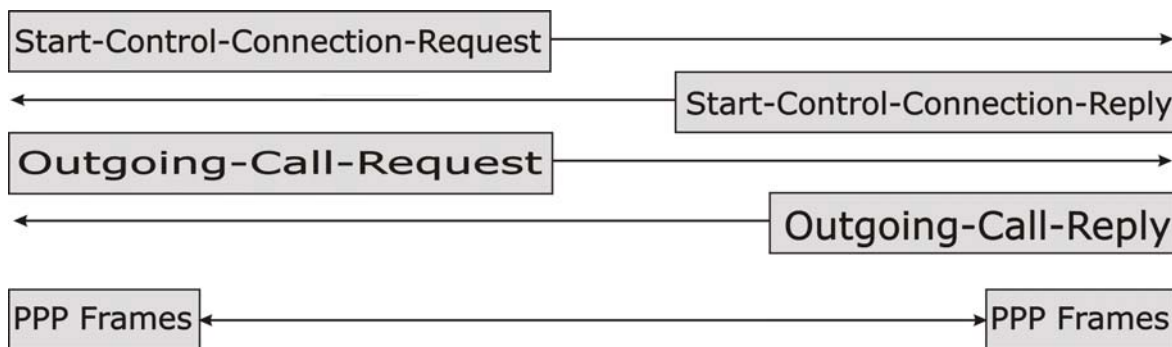

Diagram L-3 Example Message Exchange between PC and an ANT

PPP Data Connection

The PPP frames are tunneled between the PNS and PAC over GRE (General Routing Encapsulation, RFC 1701, 1702). The individual calls within a tunnel are distinguished using the **Call ID** field in the GRE header.

Appendix M

IP Subnetting

IP Addressing

Routers “route” based on the network number. The router that delivers the data packet to the correct destination host uses the host ID.

IP Classes

An IP address is made up of four octets (eight bits), written in dotted decimal notation, for example, 192.168.1.1. IP addresses are categorized into different classes. The class of an address depends on the value of its first octet.

- Class “A” addresses have a 0 in the left most bit. In a class “A” address the first octet is the network number and the remaining three octets make up the host ID.
- Class “B” addresses have a 1 in the left most bit and a 0 in the next left most bit. In a class “B” address the first two octets make up the network number and the two remaining octets make up the host ID.
- Class “C” addresses begin (starting from the left) with 1 1 0. In a class “C” address the first three octets make up the network number and the last octet is the host ID.
- Class “D” addresses begin with 1 1 1 0. Class “D” addresses are used for multicasting. (There is also a class “E” address. It is reserved for future use.)

Chart M-1 Classes of IP Addresses

IP ADDRESS:		OCTET 1	OCTET 2	OCTET 3	OCTET 4
Class A	0	Network number	Host ID	Host ID	Host ID
Class B	10	Network number	Network number	Host ID	Host ID
Class C	110	Network number	Network number	Network number	Host ID

Host IDs of all zeros or all ones are not allowed.

Therefore:

- A class “C” network (8 host bits) can have $2^8 - 2$ or 254 hosts.

➤ A class “B” address (16 host bits) can have $2^{16} - 2$ or 65534 hosts.

A class “A” address (24 host bits) can have $2^{24} - 2$ hosts (approximately 16 million hosts).

Since the first octet of a class “A” IP address must contain a “0”, the first octet of a class “A” address can have a value of 0 to 127.

Similarly the first octet of a class “B” must begin with “10”, therefore the first octet of a class “B” address has a valid range of 128 to 191. The first octet of a class “C” address begins with “110”, and therefore has a range of 192 to 223.

Chart M-2 Allowed IP Address Range By Class

CLASS	ALLOWED RANGE OF FIRST OCTET (BINARY)	ALLOWED RANGE OF FIRST OCTET (DECIMAL)
Class A	00000000 to 01111111	0 to 127
Class B	10000000 to 10111111	128 to 191
Class C	11000000 to 11011111	192 to 223
Class D	11100000 to 11101111	224 to 239

Subnet Masks

A subnet mask is used to determine which bits are part of the network number, and which bits are part of the host ID (using a logical AND operation). A subnet mask has 32 bits; each bit of the mask corresponds to a bit of the IP address. If a bit in the subnet mask is a “1” then the corresponding bit in the IP address is part of the network number. If a bit in the subnet mask is “0” then the corresponding bit in the IP address is part of the host ID.

Subnet masks are expressed in dotted decimal notation just as IP addresses are. The “natural” masks for class A, B and C IP addresses are as follows.

Chart M-3 “Natural” Masks

CLASS	NATURAL MASK
A	255.0.0.0
B	255.255.0.0
C	255.255.255.0

Subnetting

With subnetting, the class arrangement of an IP address is ignored. For example, a class C address no longer has to have 24 bits of network number and 8 bits of host ID. With subnetting, some of the host ID bits are converted into network number bits. By convention, subnet masks always consist of a continuous sequence of ones beginning from the left most bit of the mask, followed by a continuous sequence of zeros, for a total number of 32 bits.

Since the mask is always a continuous number of ones beginning from the left, followed by a continuous number of zeros for the remainder of the 32 bit mask, you can simply specify the number of ones instead of writing the value of each octet. This is usually specified by writing a “/” followed by the number of bits in the mask after the address.

For example, 192.1.1.0 /25 is equivalent to saying 192.1.1.0 with mask 255.255.255.128.

The following table shows all possible subnet masks for a class “C” address using both notations.

Chart M-4 Alternative Subnet Mask Notation

SUBNET MASK IP ADDRESS	SUBNET MASK “1” BITS	LAST OCTET BIT VALUE
255.255.255.0	/24	0000 0000
255.255.255.128	/25	1000 0000
255.255.255.192	/26	1100 0000
255.255.255.224	/27	1110 0000
255.255.255.240	/28	1111 0000
255.255.255.248	/29	1111 1000
255.255.255.252	/30	1111 1100

The first mask shown is the class “C” natural mask. Normally if no mask is specified it is understood that the natural mask is being used.

Example: Two Subnets

As an example, you have a class “C” address 192.168.1.0 with subnet mask of 255.255.255.0.

	NETWORK NUMBER	HOST ID
IP Address	192.168.1.	0
IP Address (Binary)	11000000.10101000.00000001.	00000000
Subnet Mask	255.255.255.	0
Subnet Mask (Binary)	11111111.11111111.11111111.	00000000

The first three octets of the address make up the network number (class “C”). You want to have two separate networks.

Divide the network 192.168.1.0 into two separate subnets by converting one of the host ID bits of the IP address to a network number bit. The “borrowed” host ID bit can be either “0” or “1” thus giving two subnets; 192.168.1.0 with mask 255.255.255.128 and 192.168.1.128 with mask 255.255.255.128.

In the following charts, shaded/bolded last octet bit values indicate host ID bits “borrowed” to form network ID bits. The number of “borrowed” host ID bits determines the number of subnets you can have. The remaining number of host ID bits (after “borrowing”) determines the number of hosts you can have on each subnet.

Chart M-5 Subnet 1

	NETWORK NUMBER	LAST OCTET BIT VALUE
IP Address	192.168.1.	0
IP Address (Binary)	11000000.10101000.00000001.	00000000
Subnet Mask	255.255.255.	128
Subnet Mask (Binary)	11111111.11111111.11111111.	10000000
Subnet Address: 192.168.1.0	Lowest Host ID: 192.168.1.1	
Broadcast Address: 192.168.1.127	Highest Host ID: 192.168.1.126	

Chart M-6 Subnet 2

	NETWORK NUMBER	LAST OCTET BIT VALUE
IP Address	192.168.1.	128
IP Address (Binary)	11000000.10101000.00000001.	10000000
Subnet Mask	255.255.255.	128
Subnet Mask (Binary)	11111111.11111111.11111111.	10000000
Subnet Address: 192.168.1.128	Lowest Host ID: 192.168.1.129	
Broadcast Address: 192.168.1.255	Highest Host ID: 192.168.1.254	

The remaining 7 bits determine the number of hosts each subnet can have. Host IDs of all zeros represent the subnet itself and host IDs of all ones are the broadcast address for that subnet, so the actual number of hosts available on each subnet in the example above is $2^7 - 2$ or 126 hosts for each subnet.

192.168.1.0 with mask 255.255.255.128 is the subnet itself, and 192.168.1.127 with mask 255.255.255.128 is the directed broadcast address for the first subnet. Therefore, the lowest IP address that can be assigned to an actual host for the first subnet is 192.168.1.1 and the highest is 192.168.1.126. Similarly the host ID range for the second subnet is 192.168.1.129 to 192.168.1.254.

Example: Four Subnets

The above example illustrated using a 25-bit subnet mask to divide a class “C” address space into two subnets. Similarly to divide a class “C” address into four subnets, you need to “borrow” two host ID bits to give four possible combinations of 00, 01, 10 and 11. The subnet mask is 26 bits (11111111.11111111.11111111.11000000) or 255.255.255.192. Each subnet contains 6 host ID bits, giving 2^6-2 or 62 hosts for each subnet (all 0’s is the subnet itself, all 1’s is the broadcast address on the subnet).

Chart M-7 Subnet 1

	NETWORK NUMBER	LAST OCTET BIT VALUE
IP Address	192.168.1.	0
IP Address (Binary)	11000000.10101000.00000001.	00000000
Subnet Mask (Binary)	11111111.11111111.11111111.	11000000
Subnet Address: 192.168.1.0		Lowest Host ID: 192.168.1.1
Broadcast Address: 192.168.1.63		Highest Host ID: 192.168.1.62

Chart M-8 Subnet 2

	NETWORK NUMBER	LAST OCTET BIT VALUE
IP Address	192.168.1.	64
IP Address (Binary)	11000000.10101000.00000001.	01000000
Subnet Mask (Binary)	11111111.11111111.11111111.	11000000
Subnet Address: 192.168.1.64		Lowest Host ID: 192.168.1.65
Broadcast Address: 192.168.1.127		Highest Host ID: 192.168.1.126

Chart M-9 Subnet 3

	NETWORK NUMBER	LAST OCTET BIT VALUE
IP Address	192.168.1.	128
IP Address (Binary)	11000000.10101000.00000001.	10000000
Subnet Mask (Binary)	11111111.11111111.11111111.	11000000

Subnet Address: 192.168.1.128	Lowest Host ID: 192.168.1.129
Broadcast Address: 192.168.1.191	Highest Host ID: 192.168.1.190

Chart M-10 Subnet 4

	NETWORK NUMBER	LAST OCTET BIT VALUE
IP Address	192.168.1.	192
IP Address (Binary)	11000000.10101000.00000001.	11 000000
Subnet Mask (Binary)	11111111.11111111.11111111.	11 000000
Subnet Address: 192.168.1.192	Lowest Host ID: 192.168.1.193	
Broadcast Address: 192.168.1.255	Highest Host ID: 192.168.1.254	

Example Eight Subnets

Similarly use a 27-bit mask to create 8 subnets (001, 010, 011, 100, 101, 110).

The following table shows class C IP address last octet values for each subnet.

Chart M-11 Eight Subnets

SUBNET	SUBNET ADDRESS	FIRST ADDRESS	LAST ADDRESS	BROADCAST ADDRESS
1	0	1	30	31
2	32	33	62	63
3	64	65	94	95
4	96	97	126	127
5	128	129	158	159
6	160	161	190	191
7	192	193	222	223
8	224	223	254	255

The following table is a summary for class “C” subnet planning.

Chart M-12 Class C Subnet Planning

NO. "BORROWED" HOST BITS	SUBNET MASK	NO. SUBNETS	NO. HOSTS PER SUBNET
1	255.255.255.128 (/25)	2	126
2	255.255.255.192 (/26)	4	62
3	255.255.255.224 (/27)	8	30
4	255.255.255.240 (/28)	16	14
5	255.255.255.248 (/29)	32	6
6	255.255.255.252 (/30)	64	2
7	255.255.255.254 (/31)	128	1

Subnetting With Class A and Class B Networks.

For class "A" and class "B" addresses the subnet mask also determines which bits are part of the network number and which are part of the host ID.

A class "B" address has two host ID octets available for subnetting and a class "A" address has three host ID octets (see *Chart M-1*) available for subnetting.

The following table is a summary for class "B" subnet planning.

Chart M-13 Class B Subnet Planning

NO. "BORROWED" HOST BITS	SUBNET MASK	NO. SUBNETS	NO. HOSTS PER SUBNET
1	255.255.128.0 (/17)	2	32766
2	255.255.192.0 (/18)	4	16382
3	255.255.224.0 (/19)	8	8190
4	255.255.240.0 (/20)	16	4094
5	255.255.248.0 (/21)	32	2046
6	255.255.252.0 (/22)	64	1022
7	255.255.254.0 (/23)	128	510
8	255.255.255.0 (/24)	256	254

Chart M-13 Class B Subnet Planning

NO. "BORROWED" HOST BITS	SUBNET MASK	NO. SUBNETS	NO. HOSTS PER SUBNET
9	255.255.255.128 (/25)	512	126
10	255.255.255.192 (/26)	1024	62
11	255.255.255.224 (/27)	2048	30
12	255.255.255.240 (/28)	4096	14
13	255.255.255.248 (/29)	8192	6
14	255.255.255.252 (/30)	16384	2
15	255.255.255.254 (/31)	32768	1

Part XVII:

Command, Log, Content Filtering and Certificates Appendices and Index

This part provides information on the command interpreter interface, firewall NetBIOS and certificate commands and logs and password protection, content filtering registration and reports and importing certificates. There is also an index of key terms.

Appendix N

Command Interpreter

The following describes how to use the command interpreter. Enter 24 in the main menu to bring up the system maintenance menu. Enter 8 to go to **Menu 24.8 - Command Interpreter Mode**. See the included disk or zyxel.com for more detailed information on these commands.

Use of undocumented commands or misconfiguration can damage the unit and possibly render it unusable.

Command Syntax

The command keywords are in `courier new` font.

Enter the command keywords exactly as shown, do not abbreviate.

The required fields in a command are enclosed in angle brackets `<>`.

The optional fields in a command are enclosed in square brackets `[]`.

The `|` symbol means “or”.

For example,

```
sys filter netbios config <type> <on|off>
```

means that you must specify the type of netbios filter and whether to turn it on or off.

Command Usage

A list of valid commands can be found by typing `help` or `?` at the command prompt. Always type the full command. Type `exit` to return to the SMT main menu when finished.

Appendix O

Firewall Commands

The following describes the firewall commands. See the *Command Interpreter* appendix for information on the command structure.

Chart O-1 Firewall Commands

FUNCTION	COMMAND	DESCRIPTION
Firewall Set-Up		
	<code>config edit firewall active <yes no></code>	This command turns the firewall on or off.
	<code>config retrieve firewall</code>	This command returns the previously saved firewall settings.
	<code>config save firewall</code>	This command saves the current firewall settings.
Display		
	<code>config display firewall</code>	This command shows the of all the firewall settings including e-mail, attack, and the sets/rules.
	<code>config display firewall set <set #></code>	This command shows the current configuration of a set; including timeout values, name, default-permit, and etc. If you don't put use a number (#) after "set", information about all of the sets/rules appears.
	<code>config display firewall set <set #> rule <rule #></code>	This command shows the current entries of a rule in a firewall rule set.

Chart O-1 Firewall Commands

FUNCTION	COMMAND	DESCRIPTION
	<code>config display firewall attack</code>	This command shows all of the attack response settings.
	<code>config display firewall e-mail</code>	This command shows all of the e-mail settings.
	<code>config display firewall ?</code>	This command shows all of the available firewall sub commands.
Edit		
E-mail	<code>config edit firewall e-mail mail-server <ip address of mail server></code>	This command sets the IP address to which the e-mail messages are sent.
	<code>config edit firewall e-mail return-addr <e-mail address></code>	This command sets the source e-mail address of the firewall e-mails.
	<code>config edit firewall e-mail email-to <e-mail address></code>	This command sets the e-mail address to which the firewall e-mails are sent.
	<code>config edit firewall e-mail policy <full hourly daily weekly></code>	This command sets how frequently the firewall log is sent via e-mail.
	<code>config edit firewall e-mail day <sunday monday tuesday wednesday thursday friday saturday></code>	This command sets the day on which the current firewall log is sent through e-mail if the ZyWALL is set to send it on a weekly basis.

Chart O-1 Firewall Commands

FUNCTION	COMMAND	DESCRIPTION
	<pre>config edit firewall e-mail hour <0-23></pre>	<p>This command sets the hour when the firewall log is sent through e- mail if the ZyWALL is set to send it on an hourly, daily or weekly basis.</p>
	<pre>config edit firewall e-mail minute <0-59></pre>	<p>This command sets the minute of the hour for the firewall log to be sent via e- mail if the ZyWALL is set to send it on a hourly, daily or weekly basis.</p>
Attack	<pre>config edit firewall attack send-alert <yes no></pre>	<p>This command enables or disables the immediate sending of DOS attack notification e-mail messages.</p>
	<pre>config edit firewall attack block <yes no></pre>	<p>Set this command to <code>yes</code> to block new traffic after the <code>tcp-max-incomplete</code> threshold is exceeded. Set it to <code>no</code> to delete the oldest half-open session when traffic exceeds the <code>tcp-max-incomplete</code> threshold.</p>
	<pre>config edit firewall attack block-minute <0-255></pre>	<p>This command sets the number of minutes for new sessions to be blocked when the <code>tcp-max-incomplete</code> threshold is reached. This command is only valid when <code>block</code> is set to <code>yes</code>.</p>
	<pre>config edit firewall attack minute-high <0-255></pre>	<p>This command sets the threshold rate of new half-open sessions per minute where the ZyWALL starts deleting old half-opened sessions until it gets them down to the <code>minute-low</code> threshold.</p>

Chart O-1 Firewall Commands

FUNCTION	COMMAND	DESCRIPTION
	<code>config edit firewall attack minute-low <0-255></code>	This command sets the threshold of half-open sessions where the ZyWALL stops deleting half-opened sessions.
	<code>config edit firewall attack max-incomplete-high <0-255></code>	This command sets the threshold of half-open sessions where the ZyWALL starts deleting old half-opened sessions until it gets them down to the max incomplete low.
	<code>config edit firewall attack max-incomplete-low <0-255></code>	This command sets the threshold where the ZyWALL stops deleting half-opened sessions.
	<code>config edit firewall attack tcp-max-incomplete <0-255></code>	This command sets the threshold of half-open TCP sessions with the same destination where the ZyWALL starts dropping half-open sessions to that destination.
Sets	<code>config edit firewall set <set #> name <desired name></code>	This command sets a name to identify a specified set.
	<code>Config edit firewall set <set #> default-permit <forward block></code>	This command sets whether a packet is dropped or allowed through, when it does not meet a rule within the set.
	<code>Config edit firewall set <set #> icmp-timeout <seconds></code>	This command sets the time period to allow an ICMP session to wait for the ICMP response.
	<code>Config edit firewall set <set #> udp-idle-timeout <seconds></code>	This command sets how long a UDP connection is allowed to remain inactive before the ZyWALL considers the connection closed.

Chart O-1 Firewall Commands

FUNCTION	COMMAND	DESCRIPTION
	Config edit firewall set <set #> connection-timeout <seconds>	This command sets how long ZyWALL waits for a TCP session to be established before dropping the session.
	Config edit firewall set <set #> fin-wait-timeout <seconds>	This command sets how long the ZyWALL leaves a TCP session open after the firewall detects a FIN-exchange (indicating the end of the TCP session).
	Config edit firewall set <set #> tcp-idle-timeout <seconds>	This command sets how long ZyWALL lets an inactive TCP connection remain open before considering it closed.
	Config edit firewall set <set #> log <yes no>	This command sets whether or not the ZyWALL creates logs for packets that match the firewall's default rule set.
Rules	Config edit firewall set <set #> rule <rule #> permit <forward block>	This command sets whether packets that match this rule are dropped or allowed through.
	Config edit firewall set <set #> rule <rule #> active <yes no>	This command sets whether a rule is enabled or not.
	Config edit firewall set <set #> rule <rule #> protocol <integer protocol value >	This command sets the protocol specification number made in this rule for ICMP.

Chart O-1 Firewall Commands

FUNCTION	COMMAND	DESCRIPTION
	Config edit firewall set <set #> rule <rule #> log <none match not-match both>	This command sets the ZyWALL to log traffic that matches the rule, doesn't match, both or neither.
	Config edit firewall set <set #> rule <rule #> alert <yes no>	This command sets whether or not the ZyWALL sends an alert e-mail when a DOS attack or a violation of a particular rule occurs.
	config edit firewall set <set #> rule <rule #> srcaddr-single <ip address>	This command sets the rule to have the ZyWALL check for traffic with this individual source address.
	config edit firewall set <set #> rule <rule #> srcaddr-subnet <ip address> <subnet mask>	This command sets a rule to have the ZyWALL check for traffic from a particular subnet (defined by IP address and subnet mask).
	config edit firewall set <set #> rule <rule #> srcaddr-range <start ip address> <end ip address>	This command sets a rule to have the ZyWALL check for traffic from this range of addresses.
	config edit firewall set <set #> rule <rule #> destaddr-single <ip address>	This command sets the rule to have the ZyWALL check for traffic with this individual destination address.
	config edit firewall set <set #> rule <rule #> destaddr-subnet <ip address> <subnet mask>	This command sets a rule to have the ZyWALL check for traffic with a particular subnet destination (defined by IP address and subnet mask).

Chart O-1 Firewall Commands

FUNCTION	COMMAND	DESCRIPTION
	config edit firewall set <set #> rule <rule #> destaddr-range <start ip address> <end ip address>	This command sets a rule to have the ZyWALL check for traffic going to this range of addresses.
	config edit firewall set <set #> rule <rule #> TCP destport-single <port #>	This command sets a rule to have the ZyWALL check for TCP traffic with this destination address. You may repeat this command to enter various, non-consecutive port numbers.
	config edit firewall set <set #> rule <rule #> TCP destport-range <start port #> <end port #>	This command sets a rule to have the ZyWALL check for TCP traffic with a destination port in this range.
	config edit firewall set <set #> rule <rule #> UDP destport-single <port #>	This command sets a rule to have the ZyWALL check for UDP traffic with this destination address. You may repeat this command to enter various, non-consecutive port numbers.
	config edit firewall set <set #> rule <rule #> UDP destport-range <start port #> <end port #>	This command sets a rule to have the ZyWALL check for UDP traffic with a destination port in this range.
Delete		
	config delete firewall e-mail	This command removes all of the settings for e-mail alert.
	config delete firewall attack	This command resets all of the attack response settings to their defaults.

Chart O-1 Firewall Commands

FUNCTION	COMMAND	DESCRIPTION
	<code>config delete firewall set <set #></code>	This command removes the specified set from the firewall configuration.
	<code>config delete firewall set <set #> rule <rule #></code>	This command removes the specified rule in a firewall configuration set.

Appendix P

NetBIOS Filter Commands

The following describes the NetBIOS packet filter commands. See the *Command Interpreter* appendix for information on the command structure.

Introduction

NetBIOS (Network Basic Input/Output System) are TCP or UDP broadcast packets that enable a computer to connect to and communicate with a LAN.

For some dial-up services such as PPPoE or PPTP, NetBIOS packets cause unwanted calls.

You can configure NetBIOS filters to do the following:

- Allow or disallow the sending of NetBIOS packets from the LAN to the WAN and from the WAN to the LAN.
- Allow or disallow the sending of NetBIOS packets through VPN connections.
- Allow or disallow NetBIOS packets to initiate calls.

Display NetBIOS Filter Settings

Syntax: `sys filter netbios disp`

This command gives a read-only list of the current NetBIOS filter modes.

```
===== NetBIOS Filter Status =====  
Between LAN and WAN: Block  
IPSec Packets: Forward  
Trigger Dial: Disabled
```

Diagram P-1 NetBIOS Display Filter Settings Command

The filter types and their default settings are as follows.

Chart P-1 NetBIOS Filter Default Settings

NAME	DESCRIPTION	EXAMPLE
Between LAN and WAN	This field displays whether NetBIOS packets are blocked or forwarded from the LAN to the WAN or from the WAN to the LAN.	Forward
IPSec Packets	This field displays whether NetBIOS packets sent through a VPN connection are blocked or forwarded.	Forward
Trigger dial	This field displays whether NetBIOS packets are allowed to initiate calls. Disabled means that NetBIOS packets are blocked from initiating calls.	Disabled

NetBIOS Filter Configuration

Syntax: `sys filter netbios config <type> <on|off>`

where

`<type>` = Identify which NetBIOS filter (numbered 0-3) to configure.

0 = LAN to WAN and WAN to LAN

3 = IPSec packet pass through

4 = Trigger Dial

`<on|off>` = For type 0, use `on` to enable the filter and block NetBIOS packets. Use `off` to disable the filter and forward NetBIOS packets.

For type 3, use `on` to block NetBIOS packets from being sent through a VPN connection. Use `off` to allow NetBIOS packets to be sent through a VPN connection.

For type 4, use `on` to allow NetBIOS packets to initiate dial backup calls. Use `off` to block NetBIOS packets from initiating dial backup calls.

Example commands

Command: `sys filter netbios config 0 on`

This command blocks LAN to WAN and WAN to LAN NetBIOS packets

Command: `sys filter netbios config 1 off`

This command forwards WAN to LAN and WAN to LAN NetBIOS packets

Command: `sys filter netbios config 3 on`

This command blocks IPSec NetBIOS packets

Command: `sys filter netbios config 4 off`

This command stops NetBIOS commands from initiating calls.

Appendix Q

Certificate Commands

The following describes the certificate commands. See the *Command Interpreter* appendix for information on the command structure.

All of these commands start with `certificate`.

Chart Q-1 Certificate Commands

COMMAND		DESCRIPTION
my_cert		
	create	
	create	selfsigned <name> <subject> [key size]
		Create a self-signed local host certificate. <name> specifies a descriptive name for the generated certificate. <subject> specifies a subject name (required) and alternative name (required). The format is "subject-name-dn;{ip,dns,email}=value". If the name contains spaces, please put it in quotes. [key size] specifies the key size. It has to be an integer from 512 to 2048. The default is 1024 bits.
	create	request <name> <subject> [key size]
		Create a certificate request and save it to the router for later manual enrollment. <name> specifies a descriptive name for the generated certification request. <subject> specifies a subject name (required) and alternative name (required). The format is "subject-name-dn;{ip,dns,email}=value". If the name contains spaces, please put it in quotes. [key size] specifies the key size. It has to be an integer from 512 to 2048. The default is 1024 bits.

Chart Q-1 Certificate Commands

COMMAND		DESCRIPTION
create	scep_enroll <name> <CA addr> <CA cert> <auth key> <subject> [key size]	Create a certificate request and enroll for a certificate immediately online using SCEP protocol. <name> specifies a descriptive name for the enrolled certificate. <CA addr> specifies the CA server address. <CA cert> specifies the name of the CA certificate. <auth key> specifies the key used for user authentication. If the key contains spaces, please put it in quotes. To leave it blank, type "". <subject> specifies a subject name (required) and alternative name (required). The format is "subject-name-dn;{ip,dns,email}=value". If the name contains spaces, please put it in quotes. [key size] specifies the key size. It has to be an integer from 512 to 2048. The default is 1024 bits.
create	cmp_enroll <name> <CA addr> <CA cert> <auth key> <subject> [key size]	Create a certificate request and enroll for a certificate immediately online using CMP protocol. <name> specifies a descriptive name for the enrolled certificate. <CA addr> specifies the CA server address. <CA cert> specifies the name of the CA certificate. <auth key> specifies the id and key used for user authentication. The format is "id:key". To leave the id and key blank, type ":". <subject> specifies a subject name (required) and alternative name (required). The format is "subject-name-dn;{ip,dns,email}=value". If the name contains spaces, please put it in quotes. [key size] specifies the key size. It has to be an integer from 512 to 2048. The default is 1024 bits.
import	[name]	Import the PEM-encoded certificate from stdin. [name] specifies the descriptive name (optional) as which the imported certificate is to be saved. For my certificate importation to be successful, a certification request corresponding to the imported certificate must already exist on ZyWALL. After the importation, the certification request will automatically be deleted. If a descriptive name is not specified for the imported certificate, the certificate will adopt the descriptive name of the certification request.
export	<name>	Export the PEM-encoded certificate to stdout for user to copy and paste. <name> specifies the name of the certificate to be exported.
view	<name>	View the information of the specified local host certificate. <name> specifies the name of the certificate to be viewed.

Chart Q-1 Certificate Commands

COMMAND		DESCRIPTION
verify	<name> [timeout]	Verify the certification path of the specified local host certificate. <name> specifies the name of the certificate to be verified. [timeout] specifies the timeout value in seconds (optional). The default timeout value is 20 seconds.
delete	<name>	Delete the specified local host certificate. <name> specifies the name of the certificate to be deleted.
list		List all my certificate names and basic information.
rename	<old name> <new name>	Rename the specified my certificate. <old name> specifies the name of the certificate to be renamed. <new name> specifies the new name as which the certificate is to be saved.
def_sel fsigned	[name]	Set the specified self-signed certificate as the default self-signed certificate. [name] specifies the name of the certificate to be set as the default self-signed certificate. If [name] is not specified, the name of the current self-signed certificate is displayed.
ca_trusted		
import	<name>	Import the PEM-encoded certificate from stdin. <name> specifies the name as which the imported CA certificate is to be saved.
export	<name>	Export the PEM-encoded certificate to stdout for user to copy and paste. <name> specifies the name of the certificate to be exported.
view	<name>	View the information of the specified trusted CA certificate. <name> specifies the name of the certificate to be viewed.
verify	<name> [timeout]	Verify the certification path of the specified trusted CA certificate. <name> specifies the name of the certificate to be verified. [timeout] specifies the timeout value in seconds (optional). The default timeout value is 20 seconds.
delete	<name>	Delete the specified trusted CA certificate. <name> specifies the name of the certificate to be deleted.
list		List all trusted CA certificate names and basic information.

Chart Q-1 Certificate Commands

COMMAND			DESCRIPTION
	rename	<old name> <new name>	Rename the specified trusted CA certificate. <old name> specifies the name of the certificate to be renamed. <new name> specifies the new name as which the certificate is to be saved.
	crl_issuer	<name> [on off]	Specify whether or not the specified CA issues CRL. <name> specifies the name of the CA certificate. [on off] specifies whether or not the CA issues CRL. If [on off] is not specified, the current crl_issuer status of the CA.
remote_trusted			
	import	<name>	Import the PEM-encoded certificate from stdin. <name> specifies the name as which the imported remote host certificate is to be saved.
	export	<name>	Export the PEM-encoded certificate to stdout for user to copy and paste. <name> specifies the name of the certificate to be exported.
	view	<name>	View the information of the specified trusted remote host certificate. <name> specifies the name of the certificate to be viewed.
	verify	<name> [timeout]	Verify the certification path of the specified trusted remote host certificate. <name> specifies the name of the certificate to be verified. [timeout] specifies the timeout value in seconds (optional). The default timeout value is 20 seconds.
	delete	<name>	Delete the specified trusted remote host certificate. <name> specifies the name of the certificate to be deleted.
	list		List all trusted remote host certificate names and basic information.
	rename	<old name> <new name>	Rename the specified trusted remote host certificate. <old name> specifies the name of the certificate to be renamed. <new name> specifies the new name as which the certificate is to be saved.
dir_service			

Chart Q-1 Certificate Commands

COMMAND			DESCRIPTION
	add	<name> <addr[:port]> [login:pswd]	Add a new directory service. <name> specifies a descriptive name as which the added directory server is to be saved. <addr[:port]> specifies the server address (required) and port (optional). The format is "server-address[:port]". The default port is 389. [login:pswd] specifies the login name and password, if required. The format is "[login:password]".
	delete	<name>	Delete the specified directory service. <name> specifies the name of the directory server to be deleted.
	view	<name>	View the specified directory service. <name> specifies the name of the directory server to be viewed.
	edit	<name> <addr[:port]> [login:pswd]	Edit the specified directory service. <name> specifies the name of the directory server to be edited. <addr[:port]> specifies the server address (required) and port (optional). The format is "server-address[:port]". The default port is 389. [login:pswd] specifies the login name and password, if required. The format is "[login:password]".
	list		List all directory service names and basic information.
	rename	<old name> <new name>	Rename the specified directory service. <old name> specifies the name of the directory server to be renamed. <new name> specifies the new name as which the directory server is to be saved.
cert_manager			
	reinit		Reinitialize the certificate manager.

Appendix R

Boot Commands

The BootModule AT commands execute from within the router's bootup software, when debug mode is selected before the main router firmware (ZyNOS) is started. When you start up your ZyWALL, you are given a choice to go into debug mode by pressing a key at the prompt shown in the following screen. In debug mode you have access to a series of boot module commands, for example ATUR (for uploading firmware) and ATLC (for uploading the configuration file). These are already discussed in the *Firmware and Configuration File Maintenance* chapter.

```
Bootbase Version: V1.02 | 08/08/2001 15:40:50
RAM: Size = 16384 Kbytes
DRAM Post: Testing: 16384K OK
FLASH: Intel 16M

ZyNOS Version: V3.50(WB.0)b3 | 08/08/2001 16:21:27

Press any key to enter debug mode within 3 seconds.
```

Diagram R-1 Option to Enter Debug Mode

Enter ATHE to view all available ZyWALL boot module commands as shown in the next screen. ATBAX allows you to change the console port speed. The x denotes the number preceding the colon to give the console port speed following the colon in the list of numbers that follows; for example ATBA3 will give a console port speed of 9.6 Kbps. ATSE displays the seed that is used to generate a password to turn on the debug flag in the firmware. The ATSH command shows product related information such as boot module version, vendor name, product model, RAS code revision, etc. ATGO allows you to continue booting the system. Most other commands aid in advanced troubleshooting and should only be used by qualified engineers.

AT	just answer OK
ATHE	print help
ATBAX	change baudrate. 1:38.4k, 2:19.2k, 3:9.6k 4:57.6k 5:115.2k
ATENx, (y)	set BootExtension Debug Flag (y=password)
ATSE	show the seed of password generator
ATTI (h,m,s)	change system time to hour:min:sec or show current time
ATDA (y,m,d)	change system date to year/month/day or show current date
ATDS	dump RAS stack
ATDT	dump Boot Module Common Area
ATDUx,y	dump memory contents from address x for length y
ATRBx	display the 8-bit value of address x
ATRWx	display the 16-bit value of address x
ATRLx	display the 32-bit value of address x
ATGO (x)	run program at addr x or boot router
ATGR	boot router
ATGT	run Hardware Test Program
ATRTw,x,y (,z)	RAM test level w, from address x to y (z iterations)
ATSH	dump manufacturer related data in ROM
ATDOx,y	download from address x for length y to PC via XMODEM
ATTD	download router configuration to PC via XMODEM
ATUR	upload router firmware to flash ROM
ATLC	upload router configuration file to flash ROM
ATXSx	xmodem select: x=0: CRC mode(default); x=1: checksum mode
ATSR	system reboot

Diagram R-2 Boot Module Commands

Appendix S

Log Descriptions

Chart S-1 System Maintenance Logs

LOG MESSAGE	DESCRIPTION
Time calibration is successful	The router has adjusted its time based on information from the time server.
Time calibration failed	The router failed to get information from the time server.
WAN interface gets IP: %s	A WAN interface got a new IP address from the DHCP, PPPoE, PPTP or dial-up server.
DHCP client IP expired	A DHCP client's IP address has expired.
DHCP server assigns %s	The DHCP server assigned an IP address to a client.
Successful SMT login	Someone has logged on to the router's SMT interface.
SMT login failed	Someone has failed to log on to the router's SMT interface.
Successful WEB login	Someone has logged on to the router's web configurator interface.
WEB login failed	Someone has failed to log on to the router's web configurator interface.
Successful TELNET login	Someone has logged on to the router via telnet.
TELNET login failed	Someone has failed to log on to the router via telnet.
Successful FTP login	Someone has logged on to the router via ftp.
FTP login failed	Someone has failed to log on to the router via ftp.
NAT Session Table is Full!	The maximum number of NAT session table entries has been exceeded and the table is full.
Starting Connectivity Monitor	Starting Connectivity Monitor.

Chart S-1 System Maintenance Logs

LOG MESSAGE	DESCRIPTION
Time initialized by Daytime Server	The router got the time and date from the Daytime server.
Time initialized by Time server	The router got the time and date from the time server.
Time initialized by NTP server	The router got the time and date from the NTP server.
Connect to Daytime server fail	The router was not able to connect to the Daytime server.
Connect to Time server fail	The router was not able to connect to the Time server.
Connect to NTP server fail	The router was not able to connect to the NTP server.
Too large ICMP packet has been dropped	The router dropped an ICMP packet that was too large.
SMT Session Begin	An SMT management session has started.
SMT Session End	An SMT management session has ended.
Configuration Change: PC = 0x%x, Task ID = 0x%x	The router is saving configuration changes.
Successful SSH login	Someone has logged on to the router's SSH server.
SSH login failed	Someone has failed to log on to the router's SSH server.
Successful HTTPS login	Someone has logged on to the router's web configurator interface using HTTPS protocol.
HTTPS login failed	Someone has failed to log on to the router's web configurator interface using HTTPS protocol.

Chart S-2 System Error Logs

LOG MESSAGE	DESCRIPTION
%s exceeds the max. number of session per host!	This attempt to create a NAT session exceeds the maximum number of NAT session table entries allowed to be created per host.
setNetBIOSFilter: calloc error	The router failed to allocate memory for the NetBIOS filter settings.
readNetBIOSFilter: calloc error	The router failed to allocate memory for the NetBIOS filter settings.
WAN connection is down.	A WAN connection is down. You cannot access the network through this interface.

Chart S-3 Access Control Logs

LOG MESSAGE	DESCRIPTION
Firewall default policy: [TCP UDP IGMP ESP GRE OSPF] <Packet Direction>	Attempted TCP/UDP/IGMP/ESP/GRE/OSPF access matched the default policy and was blocked or forwarded according to the default policy's setting.
Firewall rule [NOT] match:[TCP UDP IGMP ESP GRE OSPF] <Packet Direction>, <rule:%d>	Attempted TCP/UDP/IGMP/ESP/GRE/OSPF access matched (or did not match) a configured firewall rule (denoted by its number) and was blocked or forwarded according to the rule.
Triangle route packet forwarded: [TCP UDP IGMP ESP GRE OSPF]	The firewall allowed a triangle route session to pass through.
Packet without a NAT table entry blocked: [TCP UDP IGMP ESP GRE OSPF]	The router blocked a packet that didn't have a corresponding NAT table entry.
Router sent blocked web site message: TCP	The router sent a message to notify a user that the router blocked access to a web site that the user requested.

Chart S-4 TCP Reset Logs

LOG MESSAGE	DESCRIPTION
Under SYN flood attack, sent TCP RST	The router sent a TCP reset packet when a host was under a SYN flood attack (the TCP incomplete count is per destination host.)
Exceed TCP MAX incomplete, sent TCP RST	The router sent a TCP reset packet when the number of TCP incomplete connections exceeded the user configured threshold. (the TCP incomplete count is per destination host.) Note: Refer to TCP Maximum Incomplete in the Firewall Attack Alerts screen.
Peer TCP state out of order, sent TCP RST	The router sent a TCP reset packet when a TCP connection state was out of order. Note: The firewall refers to RFC793 Figure 6 to check the TCP state.
Firewall session time out, sent TCP RST	The router sent a TCP reset packet when a dynamic firewall session timed out. Default timeout values: ICMP idle timeout (s): 60 UDP idle timeout (s): 60 TCP connection (three way handshaking) timeout (s): 30 TCP FIN-wait timeout (s): 60 TCP idle (established) timeout (s): 3600
Exceed MAX incomplete, sent TCP RST	The router sent a TCP reset packet when the number of incomplete connections (TCP and UDP) exceeded the user-configured threshold. (Incomplete count is for all TCP and UDP connections through the firewall.) Note: When the number of incomplete connections (TCP + UDP) > "Maximum Incomplete High", the router sends TCP RST packets for TCP connections and destroys TOS (firewall dynamic sessions) until incomplete connections < "Maximum Incomplete Low".
Access block, sent TCP RST	The router sends a TCP RST packet and generates this log if you turn on the firewall TCP reset mechanism (via CI command: "sys firewall tcprst").

Chart S-5 Packet Filter Logs

LOG MESSAGE	DESCRIPTION
[TCP UDP ICMP IGMP Generic] packet filter matched (set: %d, rule: %d)	Attempted access matched a configured filter rule (denoted by its set and rule number) and was blocked or forwarded according to the rule.

Chart S-6 ICMP Logs

LOG MESSAGE	DESCRIPTION
Firewall default policy: ICMP <Packet Direction>, <type:%d>, <code:%d>	ICMP access matched the default policy and was blocked or forwarded according to the user's setting. See the section on ICMP messages for type and code details.
Firewall rule [NOT] match: ICMP <Packet Direction>, <rule:%d>, <type:%d>, <code:%d>	ICMP access matched (or didn't match) a firewall rule (denoted by its number) and was blocked or forwarded according to the rule. See the section on ICMP messages for type and code details.
Triangle route packet forwarded: ICMP	The firewall allowed a triangle route session to pass through.
Packet without a NAT table entry blocked: ICMP	The router blocked a packet that didn't have a corresponding NAT table entry.
Unsupported/out-of-order ICMP: ICMP	The firewall does not support this kind of ICMP packets or the ICMP packets are out of order.
Router reply ICMP packet: ICMP	The router sent an ICMP reply packet to the sender.

Chart S-7 CDR Logs

LOG MESSAGE	DESCRIPTION
<pre>board %d line %d channel %d, call %d, %s C01 Outgoing Call dev=%x ch=%x %s</pre>	<p>The router received the setup requirements for a call. "call" is the reference (count) number of the call. "dev" is the device type (3 is for dial-up, 6 is for PPPoE, 10 is for PPTP). "channel" or "ch" is the call channel ID.</p> <p>For example, "board 0 line 0 channel 0, call 3, C01 Outgoing Call dev=6 ch=0 " Means the router has dialed to the PPPoE server 3 times.</p>
<pre>board %d line %d channel %d, call %d, %s C02 OutCall Connected %d %s</pre>	<p>The PPPoE, PPTP or dial-up call is connected.</p>
<pre>board %d line %d channel %d, call %d, %s C02 Call Terminated</pre>	<p>The PPPoE, PPTP or dial-up call was disconnected.</p>

Chart S-8 PPP Logs

LOG MESSAGE	DESCRIPTION
ppp:LCP Starting	The PPP connection's Link Control Protocol stage has started.
ppp:LCP Opening	The PPP connection's Link Control Protocol stage is opening.
ppp:CHAP Opening	The PPP connection's Challenge Handshake Authentication Protocol stage is opening.
ppp:IPCP Starting	The PPP connection's Internet Protocol Control Protocol stage is starting.
ppp:IPCP Opening	The PPP connection's Internet Protocol Control Protocol stage is opening.
ppp:LCP Closing	The PPP connection's Link Control Protocol stage is closing.
ppp:IPCP Closing	The PPP connection's Internet Protocol Control Protocol stage is closing.

Chart S-9 UPnP Logs

LOG MESSAGE	DESCRIPTION
UPnP pass through Firewall	UPnP packets can pass through the firewall.

Chart S-10 Content Filtering Logs

LOG MESSAGE	DESCRIPTION
%s: Keyword blocking	The content of a requested web page matched a user defined keyword.
%s: Not in trusted web list	The web site is not in a trusted domain, and the router blocks all traffic except trusted domain sites.
%s: Forbidden Web site	The web site is in the forbidden web site list.
%s: Contains ActiveX	The web site contains ActiveX.
%s: Contains Java applet	The web site contains a Java applet.
%s: Contains cookie	The web site contains a cookie.
%s: Proxy mode detected	The router detected proxy mode in the packet.
%s	The content filter server responded that the web site is in the blocked category list, but it did not return the category type.
%s: %s	The content filter server responded that the web site is in the blocked category list, and returned the category type.
%s(cache hit)	The system detected that the web site is in the blocked list from the local cache, but does not know the category type.
%s :%s(cache hit)	The system detected that the web site is in blocked list from the local cache, and knows the category type.
%s: Trusted Web site	The web site is in a trusted domain.
%s	When the content filter is not on according to the time schedule or you didn't select the "Block Matched Web Site" checkbox, the system forwards the web content.

Chart S-11 Attack Logs

LOG MESSAGE	DESCRIPTION
attack [TCP UDP IGMP ESP GRE OSPF]	The firewall detected a TCP/UDP/IGMP/ESP/GRE/OSPF attack.
attack ICMP (type:%d, code:%d)	The firewall detected an ICMP attack, see the section on ICMP messages for type and code details.
land [TCP UDP IGMP ESP GRE OSPF]	The firewall detected a TCP/UDP/IGMP/ESP/GRE/OSPF land attack.
land ICMP (type:%d, code:%d)	The firewall detected an ICMP land attack, see the section on ICMP messages for type and code details.
ip spoofing - WAN [TCP UDP IGMP ESP GRE OSPF]	The firewall detected an IP spoofing attack on the WAN port.
ip spoofing - WAN ICMP (type:%d, code:%d)	The firewall detected an ICMP IP spoofing attack on the WAN port. See the section on ICMP messages for type and code details.
icmp echo : ICMP (type:%d, code:%d)	The firewall detected an ICMP echo attack. See the section on ICMP messages for type and code details.
syn flood TCP	The firewall detected a TCP syn flood attack.
ports scan TCP	The firewall detected a TCP port scan attack.
teardrop TCP	The firewall detected a TCP teardrop attack.
teardrop UDP	The firewall detected an UDP teardrop attack.
teardrop ICMP (type:%d, code:%d)	The firewall detected an ICMP teardrop attack, see the section on ICMP messages for type and code details.
illegal command TCP	The firewall detected a TCP illegal command attack.
NetBIOS TCP	The firewall detected a TCP NetBIOS attack.
ip spoofing - no routing entry [TCP UDP IGMP ESP GRE OSPF]	The firewall classified a packet with no source routing entry as an IP spoofing attack.
ip spoofing - no routing entry ICMP (type:%d, code:%d)	The firewall classified an ICMP packet with no source routing entry as an IP spoofing attack.

Chart S-11 Attack Logs

LOG MESSAGE	DESCRIPTION
vulnerability ICMP (type:%d, code:%d)	The firewall detected an ICMP vulnerability attack, see the section on ICMP messages for type and code details.
traceroute ICMP (type:%d, code:%d)	The firewall detected an ICMP traceroute attack, see the section on ICMP messages for type and code details.

Chart S-12 IPSec Logs

LOG MESSAGE	DESCRIPTION
Discard REPLAY packet	The router received and discarded a packet with an incorrect sequence number.
Inbound packet authentication failed	The router received a packet that has been altered. A third party may have altered or tampered with the packet.
Receive IPSec packet, but no corresponding tunnel exists	The router dropped an inbound packet for which SPI could not find a corresponding phase 2 SA.
Rule <%d> idle time out, disconnect	The router dropped a connection that had outbound traffic and no inbound traffic for a certain time period. You can use the "ipsec timer chk_conn" CLI command to set the time period. The default value is 2 minutes.
WAN IP changed to <IP>	The router dropped all connections with the "MyIP" configured as "0.0.0.0" when the WAN IP address changed.

Chart S-13 IKE Logs

LOG MESSAGE	DESCRIPTION
Active connection allowed exceeded	The IKE process for a new connection failed because the limit of simultaneous phase 2 SAs has been reached.
Start Phase 2: Quick Mode	Phase 2 Quick Mode has started.
Verifying Remote ID failed:	The connection failed during IKE phase 2 because the router and the peer's Local/Remote Addresses don't match.

Chart S-13 IKE Logs

LOG MESSAGE	DESCRIPTION
Verifying Local ID failed:	The connection failed during IKE phase 2 because the router and the peer's Local/Remote Addresses don't match.
IKE Packet Retransmit	The router retransmitted the last packet sent because there was no response from the peer.
Failed to send IKE Packet	An Ethernet error stopped the router from sending IKE packets.
Too many errors! Deleting SA	An SA was deleted because there were too many errors.
Phase 1 IKE SA process done	The phase 1 IKE SA process has been completed.
Duplicate requests with the same cookie	The router received multiple requests from the same peer while still processing the first IKE packet from the peer.
IKE Negotiation is in process	The router has already started negotiating with the peer for the connection, but the IKE process has not finished yet.
No proposal chosen	Phase 1 or phase 2 parameters don't match. Please check all protocols / settings. Ex. One device being configured for 3DES and the other being configured for DES causes the connection to fail.
Local / remote IPs of incoming request conflict with rule <%d>	The security gateway is set to "0.0.0.0" and the router used the peer's "Local Address" as the router's "Remote Address". This information conflicted with static rule #d; thus the connection is not allowed.
Cannot resolve Secure Gateway Addr for rule <%d>	The router couldn't resolve the IP address from the domain name that was used for the secure gateway address.
Peer ID: <peer id> <My remote type> -<My local type>	The displayed ID information did not match between the two ends of the connection.
vs. My Remote <My remote> -<My remote>	The displayed ID information did not match between the two ends of the connection.
vs. My Local <My local>-<My local>	The displayed ID information did not match between the two ends of the connection.
Send <packet>	A packet was sent.

Chart S-13 IKE Logs

LOG MESSAGE	DESCRIPTION
Recv <packet>	IKE uses ISAKMP to transmit data. Each ISAKMP packet contains many different types of payloads. All of them show in the LOG. Refer to RFC2408 – ISAKMP for a list of all ISAKMP payload types.
Recv <Main or Aggressive> Mode request from <IP>	The router received an IKE negotiation request from the peer address specified.
Send <Main or Aggressive> Mode request to <IP>	The router started negotiation with the peer.
Invalid IP <Peer local> / <Peer local>	The peer's "Local IP Address" is invalid.
Remote IP <Remote IP> / <Remote IP> conflicts	The security gateway is set to "0.0.0.0" and the router used the peer's "Local Address" as the router's "Remote Address". This information conflicted with static rule #d; thus the connection is not allowed.
Phase 1 ID type mismatch	This router's "Peer ID Type" is different from the peer IPSec router's "Local ID Type".
Phase 1 ID content mismatch	This router's "Peer ID Content" is different from the peer IPSec router's "Local ID Content".
No known phase 1 ID type found	The router could not find a known phase 1 ID in the connection attempt.
ID type mismatch. Local / Peer: <Local ID type/Peer ID type>	The phase 1 ID types do not match.
ID content mismatch	The phase 1 ID contents do not match.
Configured Peer ID Content: <Configured Peer ID Content>	The phase 1 ID contents do not match and the configured "Peer ID Content" is displayed.
Incoming ID Content: <Incoming Peer ID Content>	The phase 1 ID contents do not match and the incoming packet's ID content is displayed.
Unsupported local ID Type: <%d>	The phase 1 ID type is not supported by the router.
Build Phase 1 ID	The router has started to build the phase 1 ID.

Chart S-13 IKE Logs

LOG MESSAGE	DESCRIPTION
Adjust TCP MSS to %d	The router automatically changed the TCP Maximum Segment Size value after establishing a tunnel.
Rule <%d> input idle time out, disconnect	The tunnel for the listed rule was dropped because there was no inbound traffic within the idle timeout period.
XAUTH succeed! Username: <Username>	The router used extended authentication to authenticate the listed username.
XAUTH fail! Username: <Username>	The router was not able to use extended authentication to authenticate the listed username.
Rule[%d] Phase 1 negotiation mode mismatch	The listed rule's IKE phase 1 negotiation mode did not match between the router and the peer.
Rule [%d] Phase 1 encryption algorithm mismatch	The listed rule's IKE phase 1 encryption algorithm did not match between the router and the peer.
Rule [%d] Phase 1 authentication algorithm mismatch	The listed rule's IKE phase 1 authentication algorithm did not match between the router and the peer.
Rule [%d] Phase 1 authentication method mismatch	The listed rule's IKE phase 1 authentication method did not match between the router and the peer.
Rule [%d] Phase 1 key group mismatch	The listed rule's IKE phase 1 key group did not match between the router and the peer.
Rule [%d] Phase 2 protocol mismatch	The listed rule's IKE phase 2 protocol did not match between the router and the peer.
Rule [%d] Phase 2 encryption algorithm mismatch	The listed rule's IKE phase 2 encryption algorithm did not match between the router and the peer.
Rule [%d] Phase 2 authentication algorithm mismatch	The listed rule's IKE phase 2 authentication algorithm did not match between the router and the peer.
Rule [%d] Phase 2 encapsulation mismatch	The listed rule's IKE phase 2 encapsulation did not match between the router and the peer.
Rule [%d]> Phase 2 pfs mismatch	The listed rule's IKE phase 2 perfect forward secret (pfs) setting did not match between the router and the peer.

Chart S-13 IKE Logs

LOG MESSAGE	DESCRIPTION
Rule [%d] Phase 1 ID mismatch	The listed rule's IKE phase 1 ID did not match between the router and the peer.
Rule [%d] Phase 1 hash mismatch	The listed rule's IKE phase 1 hash did not match between the router and the peer.
Rule [%d] Phase 1 preshared key mismatch	The listed rule's IKE phase 1 pre-shared key did not match between the router and the peer.
Rule [%d] Tunnel built successfully	The listed rule's IPsec tunnel has been built successfully.
Rule [%d] Peer's public key not found	The listed rule's IKE phase 1 peer's public key was not found.
Rule [%d] Verify peer's signature failed	The listed rule's IKE phase 1 verification of the peer's signature failed.
Rule [%d] Sending IKE request	IKE sent an IKE request for the listed rule.
Rule [%d] Receiving IKE request	IKE received an IKE request for the listed rule.
Swap rule to rule [%d]	The router changed to using the listed rule.
Rule [%d] Phase 1 key length mismatch	The listed rule's IKE phase 1 key length (with the AES encryption algorithm) did not match between the router and the peer.
Rule [%d] phase 1 mismatch	The listed rule's IKE phase 1 did not match between the router and the peer.
Rule [%d] phase 2 mismatch	The listed rule's IKE phase 2 did not match between the router and the peer.
Rule [%d] Phase 2 key length mismatch	The listed rule's IKE phase 2 key lengths (with the AES encryption algorithm) did not match between the router and the peer.

Chart S-14 PKI Logs

LOG MESSAGE	DESCRIPTION
Enrollment successful	The SCEP online certificate enrollment was successful. The Destination field records the certification authority server IP address and port.
Enrollment failed	The SCEP online certificate enrollment failed. The Destination field records the certification authority server's IP address and port.
Failed to resolve <SCEP CA server url>	The SCEP online certificate enrollment failed because the certification authority server's address cannot be resolved.
Enrollment successful	The CMP online certificate enrollment was successful. The Destination field records the certification authority server's IP address and port.
Enrollment failed	The CMP online certificate enrollment failed. The Destination field records the certification authority server's IP address and port.
Failed to resolve <CMP CA server url>	The CMP online certificate enrollment failed because the certification authority server's IP address cannot be resolved.
Rcvd ca cert: <subject name>	The router received a certification authority certificate, with subject name as recorded, from the LDAP server whose IP address and port are recorded in the Source field.
Rcvd user cert: <subject name>	The router received a user certificate, with subject name as recorded, from the LDAP server whose IP address and port are recorded in the Source field.
Rcvd CRL <size>: <issuer name>	The router received a CRL (Certificate Revocation List), with size and issuer name as recorded, from the LDAP server whose IP address and port are recorded in the Source field.
Rcvd ARL <size>: <issuer name>	The router received an ARL (Authority Revocation List), with size and issuer name as recorded, from the LDAP server whose address and port are recorded in the Source field.
Failed to decode the received ca cert	The router received a corrupted certification authority certificate from the LDAP server whose address and port are recorded in the Source field.
Failed to decode the received user cert	The router received a corrupted user certificate from the LDAP server whose address and port are recorded in the Source field.

Chart S-14 PKI Logs

LOG MESSAGE	DESCRIPTION
Failed to decode the received CRL	The router received a corrupted CRL (Certificate Revocation List) from the LDAP server whose address and port are recorded in the Source field.
Failed to decode the received ARL	The router received a corrupted ARL (Authority Revocation List) from the LDAP server whose address and port are recorded in the Source field.
Rcvd data <size> too large! Max size allowed: <max size>	The router received directory data that was too large (the size is listed) from the LDAP server whose address and port are recorded in the Source field. The maximum size of directory data that the router allows is also recorded.
Cert trusted: <subject name>	The router has verified the path of the certificate with the listed subject name.
Due to <reason codes>, cert not trusted: <subject name>	Due to the reasons listed, the certificate with the listed subject name has not passed the path verification. The recorded reason codes are only approximate reasons for not trusting the certificate. Please refer to <i>Chart S-15</i> for the corresponding descriptions of the codes.

Chart S-15 Certificate Path Verification Failure Reason Codes

CODE	DESCRIPTION
1	Algorithm mismatch between the certificate and the search constraints.
2	Key usage mismatch between the certificate and the search constraints.
3	Certificate was not valid in the time interval.
4	(Not used)
5	Certificate is not valid.
6	Certificate signature was not verified correctly.
7	Certificate was revoked by a CRL.
8	Certificate was not added to the cache.

Chart S-15 Certificate Path Verification Failure Reason Codes

CODE	DESCRIPTION
9	Certificate decoding failed.
10	Certificate was not found (anywhere).
11	Certificate chain looped (did not find trusted root).
12	Certificate contains critical extension that was not handled.
13	Certificate issuer was not valid (CA specific information missing).
14	(Not used)
15	CRL is too old.
16	CRL is not valid.
17	CRL signature was not verified correctly.
18	CRL was not found (anywhere).
19	CRL was not added to the cache.
20	CRL decoding failed.
21	CRL is not currently valid, but in the future.
22	CRL contains duplicate serial numbers.
23	Time interval is not continuous.
24	Time information not available.
25	Database method failed due to timeout.
26	Database method failed.
27	Path was not verified.
28	Maximum path length reached.

Chart S-16 802.1X Logs

LOG MESSAGE	DESCRIPTION
Local User Database accepts user.	A user was authenticated by the local user database.

Chart S-16 802.1X Logs

LOG MESSAGE	DESCRIPTION
Local User Database reports user credential error.	A user was not authenticated by the local user database because of an incorrect user password.
Local User Database does not find user's credential.	A user was not authenticated by the local user database because the user is not listed in the local user database.
RADIUS accepts user.	A user was authenticated by the RADIUS Server.
RADIUS rejects user. Pls check RADIUS Server.	A user was not authenticated by the RADIUS Server. Please check the RADIUS Server.
Local User Database does not support authentication method.	The local user database only supports the EAP-MD5 method. A user tried to use another authentication method and was not authenticated.
User logout because of session timeout expired.	The router logged out a user whose session expired.
User logout because of user deassociation.	The router logged out a user who ended the session.
User logout because of no authentication response from user.	The router logged out a user from which there was no authentication response.
User logout because of idle timeout expired.	The router logged out a user whose idle timeout period expired.
User logout because of user request.	A user logged out.
Local User Database does not support authentication method.	A user tried to use an authentication method that the local user database does not support (it only supports EAP-MD5).
No response from RADIUS. Pls check RADIUS Server.	There is no response message from the RADIUS server, please check the RADIUS server.
Use Local User Database to authenticate user.	The local user database is operating as the authentication server.
Use RADIUS to authenticate user.	The RADIUS server is operating as the authentication server.
No Server to authenticate user.	There is no authentication server to authenticate a user.

Chart S-16 802.1X Logs

LOG MESSAGE	DESCRIPTION
Local User Database does not find user's credential.	A user was not authenticated by the local user database because the user is not listed in the local user database.

Chart S-17 ACL Setting Notes

PACKET DIRECTION	DIRECTION	DESCRIPTION
(L to W)	LAN to WAN	ACL set for packets traveling from the LAN to the WAN.
(W to L)	WAN to LAN	ACL set for packets traveling from the WAN to the LAN.
(D to L)	DMZ to LAN	ACL set for packets traveling from the DMZ to the LAN.
(D to W)	DMZ to WAN	ACL set for packets traveling from the DMZ to the WAN.
(W to D)	WAN to DMZ	ACL set for packets traveling from the WAN to the DMZ.
(L to D)	LAN to DMZ	ACL set for packets traveling from the LAN to the DMZ.
(L to L/ZW)	LAN to LAN/ZyWALL	ACL set for packets traveling from the LAN to the LAN or the ZyWALL.
(W to W/ZW)	WAN to WAN/ZyWALL	ACL set for packets traveling from the WAN to the WAN or the ZyWALL.
(D to D/ZW)	DMZ to DMZ/ZyWALL	ACL set for packets traveling from the DMZ to the DM or the ZyWALL.

Chart S-18 ICMP Notes

TYPE	CODE	DESCRIPTION
0		Echo Reply
	0	Echo reply message
3		Destination Unreachable
	0	Net unreachable
	1	Host unreachable

Chart S-18 ICMP Notes

TYPE	CODE	DESCRIPTION
	2	Protocol unreachable
	3	Port unreachable
	4	A packet that needed fragmentation was dropped because it was set to Don't Fragment (DF)
	5	Source route failed
4		Source Quench
	0	A gateway may discard internet datagrams if it does not have the buffer space needed to queue the datagrams for output to the next network on the route to the destination network.
5		Redirect
	0	Redirect datagrams for the Network
	1	Redirect datagrams for the Host
	2	Redirect datagrams for the Type of Service and Network
	3	Redirect datagrams for the Type of Service and Host
8		Echo
	0	Echo message
11		Time Exceeded
	0	Time to live exceeded in transit
	1	Fragment reassembly time exceeded
12		Parameter Problem
	0	Pointer indicates the error
13		Timestamp
	0	Timestamp request message
14		Timestamp Reply
	0	Timestamp reply message
15		Information Request

Chart S-18 ICMP Notes

TYPE	CODE	DESCRIPTION
	0	Information request message
16		Information Reply
	0	Information reply message

Chart S-19 Syslog Logs

LOG MESSAGE	DESCRIPTION
<pre><Facility*8 + Severity>Mon dd hr:mm:ss hostname src="<srcIP:srcPort>" dst="<dstIP:dstPort>" msg="<msg>" note="<note>" devID="<mac address last three numbers>" cat="<category>"</pre>	<p>This message is sent by the system ("RAS" displays as the system name if you haven't configured one) when the router generates a syslog. The facility is defined in the web MAIN MENU->LOGS->Log Settings page. The severity is the log's syslog class. The definition of messages and notes are defined in the various log charts throughout this appendix. The "devID" is the last three characters of the MAC address of the router's LAN port. The "cat" is the same as the category in the router's logs.</p>

The following table shows RFC-2408 ISAKMP payload types that the log displays. Please refer to the RFC for detailed information on each type.

Chart S-20 RFC-2408 ISAKMP Payload Types

LOG DISPLAY	PAYLOAD TYPE
SA	Security Association
PROP	Proposal
TRANS	Transform
KE	Key Exchange
ID	Identification
CER	Certificate
CER_REQ	Certificate Request
HASH	Hash

Chart S-20 RFC-2408 ISAKMP Payload Types

LOG DISPLAY	PAYLOAD TYPE
SIG	Signature
NONCE	Nonce
NOTFY	Notification
DEL	Delete
VID	Vendor ID

Log Commands

Go to the command interpreter interface (the *Command Interpreter Appendix* explains how to access and use the commands).

Configuring What You Want the ZyWALL to Log

- Step 1.** Use the `sys logs load` command to load the log setting buffer that allows you to configure which logs the ZyWALL is to record.
- Step 2.** Use `sys logs category` to view a list of the log categories.

```

ras> sys logs category
8021x      access      attack
error     icmp         ike         ipsec
javablocked mten        packetfilter ppp
cdr        pki         tls         remote
tcpreset  upnp        urlblocked  urlforward
wireless

```

Diagram S-1 Displaying Log Categories Example

- Step 3.** Use `sys logs category` followed by a log category to display the parameters that are available for the category.

```
ras> sys logs category access
Usage: [0:none/1:log/2:alert/3:both]
```

Diagram S-2 Displaying Log Parameters Example

Step 4. Use `sys logs category` followed by a log category and a parameter to decide what to record.

Use 0 to not record logs for that category, 1 to record only logs for that category, 2 to record only alerts for that category, and 3 to record both logs and alerts for that category. Not every parameter is available with every category.

Step 5. Use the `sys logs save` command to store the settings in the ZyWALL (you must do this in order to record logs).

Displaying Logs

- Use the `sys logs display` command to show all of the logs in the ZyWALL's log.
- Use the `sys logs category display` command to show the log settings for all of the log categories.
- Use the `sys logs display [log category]` command to show the logs in an individual ZyWALL log category.
- Use the `sys logs clear` command to erase all of the ZyWALL's logs.

Log Command Example

This example shows how to set the ZyWALL to record the access logs and alerts and then view the results.

```
ras> sys logs load
ras> sys logs category access 3
ras> sys logs save
ras> sys logs display access
```

```
# .time          source          destination
notes
```

message

0|11/11/2002 15:10:12 |172.22.3.80:137 |172.22.255.255:137
|ACCESS BLOCK

Firewall default policy: UDP(set:8)

1|11/11/2002 15:10:12 |172.21.4.17:138 |172.21.255.255:138
|ACCESS BLOCK

Firewall default policy: UDP(set:8)

2|11/11/2002 15:10:11 |172.17.2.1 |224.0.1.60
|ACCESS BLOCK

Firewall default policy: IGMP(set:8)

3|11/11/2002 15:10:11 |172.22.3.80:137 |172.22.255.255:137
|ACCESS BLOCK

Firewall default policy: UDP(set:8)

4|11/11/2002 15:10:10 |192.168.10.1:520 |192.168.10.255:520
|ACCESS BLOCK

Firewall default policy: UDP(set:8)

5|11/11/2002 15:10:10 |172.21.4.67:137 |172.21.255.255:137
|ACCESS BLOCK

Appendix T

Brute-Force Password Guessing Protection

The following describes the commands for enabling, disabling and configuring the brute-force password guessing protection mechanism for the password. See the *Command Interpreter* appendix for information on the command structure.

Chart T-1 Brute-Force Password Guessing Protection Commands

COMMAND	DESCRIPTION
<code>sys pwdertrm</code>	This command displays the brute-force guessing password protection settings.
<code>sys pwdertrm 0</code>	This command turns off the password's protection from brute-force guessing. The brute-force password guessing protection is turned off by default.
<code>sys pwdertrm N</code>	This command sets the password protection to block all access attempts for N (a number from 1 to 60) minutes after the third time an incorrect password is entered.

Example

<code>sys pwdertrm 5</code>	This command sets the password protection to block all access attempts for five minutes after the third time an incorrect password is entered.
-----------------------------	--

Appendix U

Importing Certificates

This appendix shows examples of importing certificates.

Importing the ZyWALL's Certificate into Netscape Navigator

In Netscape Navigator, you can permanently trust the ZyWALL's server certificate by importing it into your operating system as a trusted certification authority.

Select **Accept This Certificate Permanently** in the following screen to do this.



Diagram U-1 Security Certificate

Importing the ZyWALL's Certificate into Internet Explorer

For Internet Explorer to trust a self-signed certificate from the ZyWALL, simply import the self-signed certificate into your operating system as a trusted certification authority.

To have Internet Explorer trust a ZyWALL certificate issued by a certificate authority, import the certificate authority's certificate into your operating system as a trusted certification authority.

The following example procedure shows how to import the ZyWALL's (self-signed) server certificate into your operating system as a trusted certification authority.

Step 1. In Internet Explorer, double click the lock shown in the following screen.



Diagram U-2 Login Screen

Step 2. Click **Install Certificate** to open the Install Certificate wizard.



Diagram U-3 Certificate General Information Before Import

Step 3. Click **Next** to begin the **Install Certificate** wizard.



Diagram U-4 Certificate Import Wizard 1

Step 4. Select where you would like to store the certificate and then click **Next**.

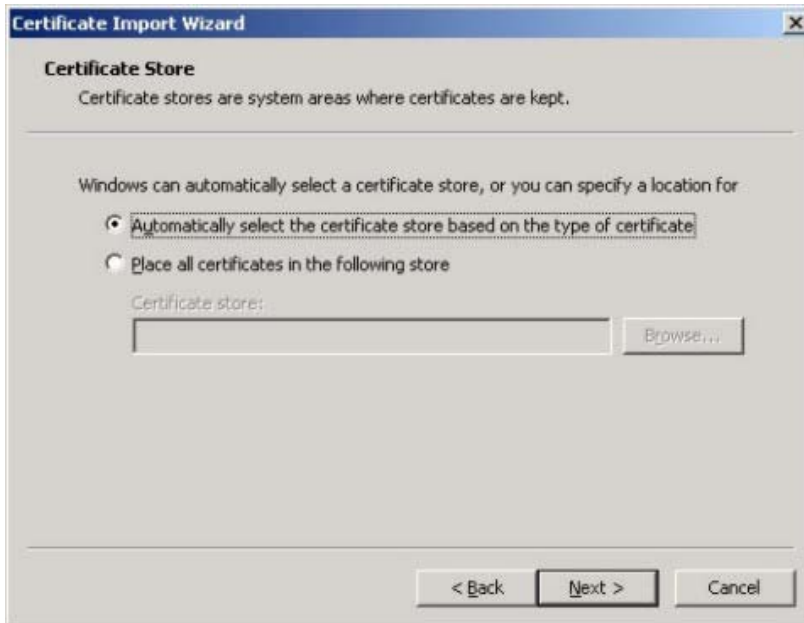

Diagram U-5 Certificate Import Wizard 2

Step 5. Click **Finish** to complete the **Import Certificate** wizard.



Diagram U-6 Certificate Import Wizard 3

Step 6. Click **Yes** to add the ZyWALL's certificate to the root store.

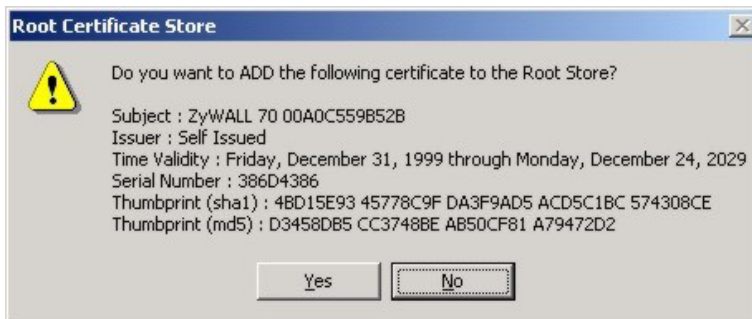

Diagram U-7 Root Certificate Store



Diagram U-8 Certificate General Information after Import

Enrolling and Importing SSL Client Certificates

The SSL client needs a certificate if **Authenticate Client Certificates** is selected on the ZyWALL.

You must have imported at least one trusted CA to the ZyWALL in order for the **Authenticate Client Certificates** to be active (see the part on certificates for details).

Apply for a certificate from a Certification Authority (CA) that is trusted by the ZyWALL (see the ZyWALL's **Trusted CA** web configurator screen).

CERTIFICATES

My Certificates Trusted CAs Trusted Remote Hosts Directory Servers

PKI Storage Space in Use
0%  100%

Trusted CA Setting

#	Name	Subject	Issuer	Valid From	Valid To	CRL Issuer
1	trusted_ca_1.cer	CN=CSO-CA, C-TW	CN=CSO-CA, C-TW	2003 Aug 30th, 00:29:51 GMT (Not Yet Valid)	2005 Aug 30th, 00:38:10 GMT	No
2	trusted_ca_2.cer	CN=ZyAIRCA, OU=ZyAIR, O=ZyXEL PQA, L=Hsin-Chiu, ST=Taiwan, C-TW, MAILTO=jsheen@zyxel.com.tw	CN=ZyAIRCA, OU=ZyAIR, O=ZyXEL PQA, L=Hsin-Chiu, ST=Taiwan, C-TW, MAILTO=jsheen@zyxel.com.tw	2002 Nov 20th, 00:58:55 GMT (Not Yet Valid)	2004 Nov 20th, 00:58:55 GMT	No

Diagram U-9 ZyWALL Trusted CA Screen

The CA sends you a package containing the CA's certificate(s), your personal certificate(s) and a password to install the personal certificate(s).

Installing the CA's Certificate

Step 1. Double click the CA's certificate to produce a screen similar to the one shown next.

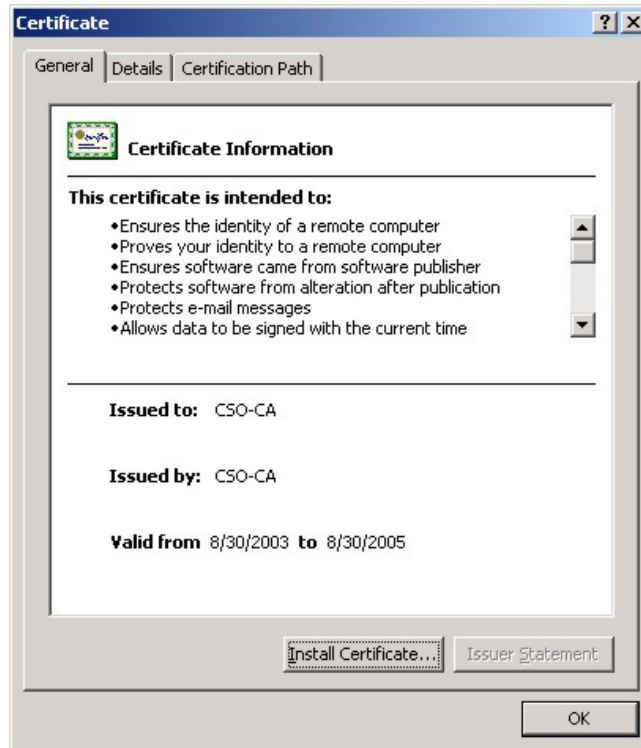

Diagram U-10 CA Certificate Example

- Step 2.** Click Install Certificate and follow the wizard as shown in the Importing the ZyWALL's Certificate into the SSL Client section.

Installing Your Personal Certificate(s)

You need a password in advance. The CA may issue the password or you may have to specify it during the enrollment. Double-click the personal certificate given to you by the CA to produce a screen similar to the one shown next.

- Step 1.** Click Next to begin the wizard.



Diagram U-11 Personal Certificate Import Wizard 1

Step 2. The file name and path of the certificate you double-clicked should automatically appear in the **File name** text box. Click **Browse** if you wish to import a different certificate.

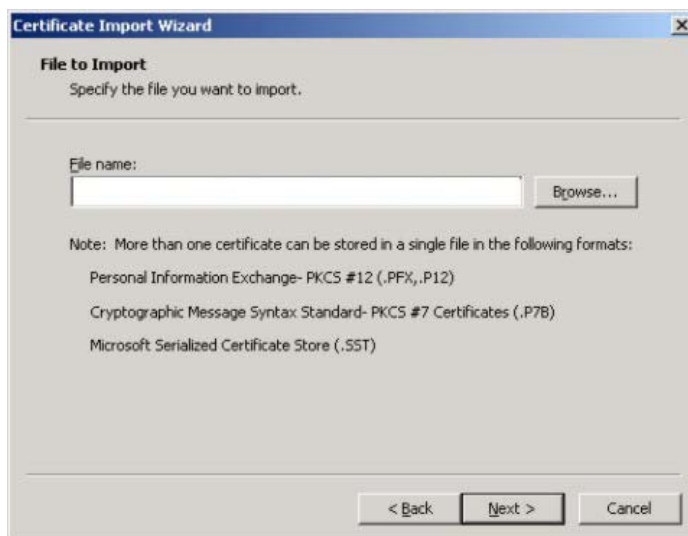

Diagram U-12 Personal Certificate Import Wizard 2

Step 3. Enter the password.

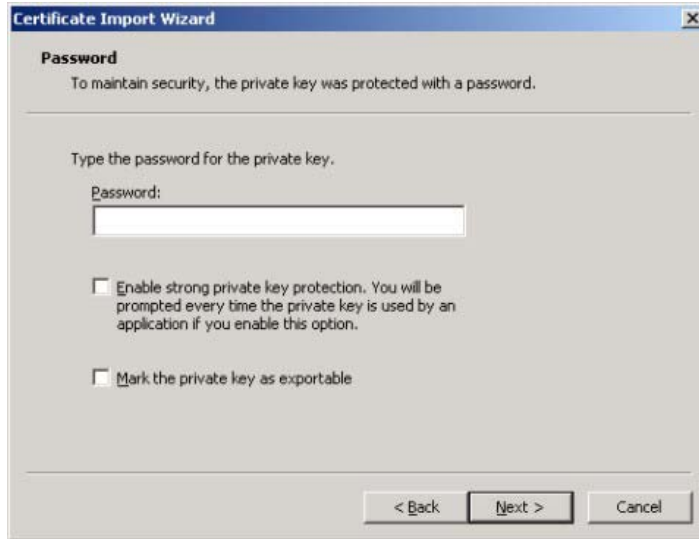

Diagram U-13 Personal Certificate Import Wizard 3

Step 4. Have the wizard determine where the certificate should be saved on your computer or select **Place all certificates in the following store** and choose a different location.

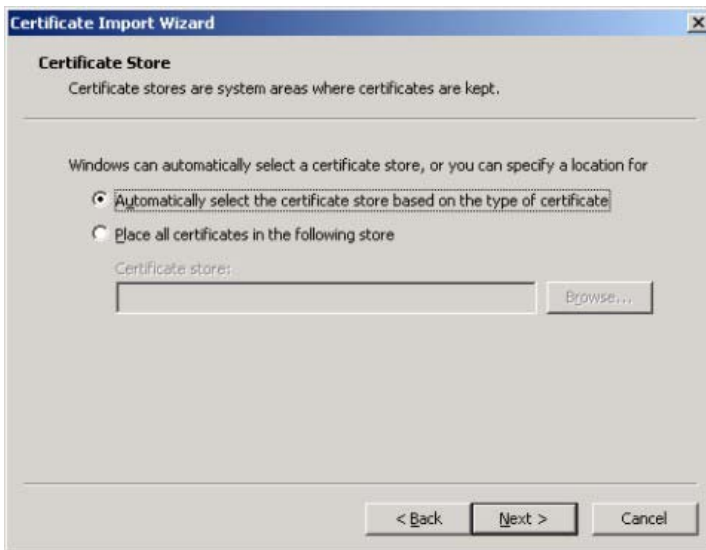

Diagram U-14 Personal Certificate Import Wizard 4

Step 5. Click **Finish** to complete the wizard and begin the import process.



Diagram U-15 Personal Certificate Import Wizard 5

Step 6. You should see the following screen when the certificate is correctly installed on your computer.



Diagram U-16 Personal Certificate Import Wizard 6

Using a Certificate When Accessing the ZyWALL Example

Use the following procedure to access the ZyWALL via HTTPS.

Step 1. Enter 'https://ZyWALL IP Address/' in your browser's web address field.



Diagram U-17 Access the ZyWALL Via HTTPS

Step 2. When **Authenticate Client Certificates** is selected on the ZyWALL, the following screen asks you to select a personal certificate to send to the ZyWALL. This screen displays even if you only have a single certificate as in the example.

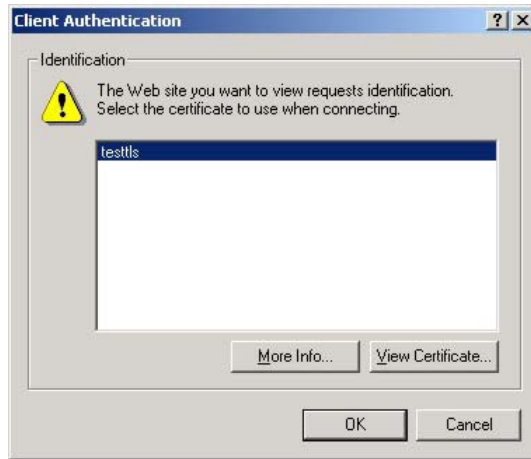

Diagram U-18 SSL Client Authentication

Step 3. You next see the ZyWALL login screen.



Diagram U-19 ZyWALL Secure Login Screen

Appendix V

Index

1

10/100 Mbps Ethernet WAN 1-2

A

Access Point 25-8

Action for Matched Packets 12-12

Active 24-7, 24-9, 28-3

Address Assignment 3-8, 3-9

Ad-hoc Configuration H-2

Allocated Budget 24-8, 28-6

Alternative Subnet Mask Notation M-3

Application-level Firewalls 11-1

Applications 1-9

AT command 24-3, 24-4, 35-2

Attack Alert 12-24, 12-26

Attack Types 11-6

Authen 24-7, 28-6

Authentication 24-7, 28-5, 28-6

Authentication Protocol 28-5

Auto-crossover 10/100 Mbps Ethernet LAN ... 1-2

Auto-negotiating 10/100 Mbps Ethernet DMZ 1-2

Auto-negotiating 10/100 Mbps Ethernet LAN. 1-2

Auxiliary 1-2

B

Backup 21-8, 35-2

Backup WAN 1-2

Bandwidth Management 1-3

Basic Service Set H-2

Big Picture G-1

Blocking Time 12-25, 12-26, 12-28

Boot commands R-1

Broadband Access Security Gateway xxxix

Brute-force Attack, 11-6

BSS See Basic Service Set

Budget Management 36-4

Bypass Triangle Route 12-8

C

CA J-1

Cable Modem 11-2, A-3

Call Back Delay 24-6

Call Control 36-3

Call History 36-5

Call Scheduling 1-4, 39-1

 Max Number of Schedule Sets 39-1

 PPPoE 39-3

Precedence	39-1	Customizing.....	13-15
Call-Triggerring Packet	34-10	Days and Times	13-1
Canada	iv	Filter List	13-1
Caution.....	iv	Restrict Web Features.....	13-1
Certificate Authority	See CA	Copyright.....	ii
Certificate Commands	Q-1	Custom Ports	
Changing the Password.....	22-7	Creating/Editing	12-14
Channel ID.....	6-5, 25-8	Customer Support.....	vi
CHAP	24-7, 28-6		
Classes of IP Addresses	M-1	D	
Command Interpreter Mode.....	36-1	DDNS	
Command Line	35-3	Configuration.....	23-3
Community	33-1	DDNS Type.....	23-3
Computer's IP Address.....	E-1	Default.....	21-10
Configuration.....	5-1, 21-4	Default Policy Log	12-9
Configuration File		DeMilitarized Zone	7-1
Backup.....	35-2	Denial of Service	11-2, 11-3, 12-25, 31-1
Maintenance.....	35-1	Denial of Services	
Connection ID/Name	28-7	Thresholds	12-26
Console Port	34-3, 34-4, 34-5, B-2	Destination Address	12-4, 12-12
Configuration File Upload	35-17	DHCP	3-1, 3-9, 5-1, 5-3, 21-4, 25-3
File Backup.....	35-7	DHCP (Dynamic Host Configuration Protocol). 1-	
File Upload	35-16	6	
Restoring Files	35-10	DHCP Ethernet Setup.....	25-2
Console/Dial Backup Port Pin Assignments... B-2		Diagnostic.....	34-11
Content Filtering.....	1-3, 13-1	DIAL BACKUP	B-2
Categories	13-1	Dial Timeout.....	24-5
		Direct Sequence Spread Spectrum	H-2
		Disclaimer	ii

Distribution System.....	H-3	EAP.....	6-3
DMZ.....	7-1	EAP Authentication.....	XVI, J-1
And the Firewall.....	7-1	MD5.....	J-1
IP Alias.....	26-3	TLS.....	J-1
IP Alias Setup.....	See IP Alias Setup	TTLS.....	J-1
Port Filter Setup.....	26-1	ECHO.....	9-6
Setup.....	26-1, 26-2	Edit IP.....	24-7, 28-4
TCP/IP Setup.....	See TCP/IP	EMAIL.....	23-3
DMZ Setup.....	7-1, 26-1	E-mail Address.....	23-3
DNS.....	18-27	Enable Wildcard.....	23-4
DNS Server		Enable Wireless LAN.....	6-5
For VPN Host.....	15-7	Encapsulation.....	27-2, 28-3, 28-7
Domain Name.....	3-1, 3-9, 9-7, 34-3, 34-4	PPP over Ethernet.....	K-1
DoS		Enter.....	See Syntax Conventions
Basics.....	11-3	Entering Information.....	22-3
Types.....	11-4	ESS.....	See Extended Service Set
DoS (Denial of Service).....	1-3	ESS ID.....	6-1
Drop Timeout.....	24-6	ESSID.....	25-8
DS.....	See Distribution System	Ethernet.....	3-2, 3-4
DSL Modem.....	1-9, 28-4, A-3	Ethernet Cable Pin Assignments.....	B-3
DSSS.....	See Direct Sequence Spread Spectrum	Ethernet Encapsulation.....	27-1, 28-2, 28-3, 28-7, 28-11
DTR.....	8-20, 24-5	Ethernet Specification for DMZ.....	B-1
Dynamic DNS.....	4-3, 23-2	Ethernet Specification for WAN.....	B-1
Dynamic DNS Support.....	1-5	Extended Service Set.....	H-3
DYNDNS Wildcard.....	4-3	Extended Service Set IDentification.....	25-8
	E		
e.g.....	See Syntax Conventions		
			F
		Factory Default.....	24-2

Factory LAN Defaults	5-1	Creating/Editing Rules	12-10
Fail Tolerance	28-14	Custom Ports See Custom Ports. See Custom Ports	
FCC.....	iii	Enabling	12-1
FHSS... See Frequency-Hopping Spread Spectrum		Firewall Vs Filters	11-12
Filename Conventions	35-1	Guidelines For Enhancing Security	11-11
Filter	24-13, 25-1, 26-1, 28-10, 32-1	Introduction	11-2
Applying	32-16	LAN to WAN Rules	12-4
Configuration	32-1	Policies	12-1
Configuring	32-4	Rule Checklist	12-2
DMZ	32-17	Rule Logic	12-2
Example	32-13	Rule Security Ramifications	12-3
Generic Filter Rule	32-11	Services	12-21
Generic Rule	32-11	SMT Menus	31-1
NAT	32-15	Types	11-1
Remote Node	32-18	When To Use	11-12
Structure	32-2	Firewall Commands	O-1
TCP/IP Rule	32-7	Firmware File	
Filters		Maintenance	21-5, 21-7, 35-1
Executing a Filter Rule	32-2	Flow Control	22-1
IP Filter Logic Flow	32-9	Fragmentation Threshold	6-3
Finger	9-7	Frequency-Hopping Spread Spectrum	H-2
Firewall	1-3	FTP	5-1, 9-6, 9-7, 18-2, 18-22, 35-3, 37-3
Access Methods	12-1	File Upload	35-13
Activating	31-1	GUI-based Clients	35-4
Address Type	12-14	Restoring Files	35-8
Alerts	12-7	FTP File Transfer	35-12
Connection Direction	12-4	FTP Restrictions	18-2, 35-5, 37-3

IP Alias	1-5, 25-6	Name	29-2
IP Alias Setup	25-5, 25-6	Route Number	29-2
IP Classes.....	M-1	IP Subnet Mask	24-10, 25-6
IP Multicast.....	1-5	Remote	24-10
Internet Group Management Protocol (IGMP)		IPSec standard	1-3
.....	1-5	IPSec VPN Capability	1-3
IP Policies	25-5, 38-6	ISP's Name.....	27-1
IP Policy Routing.....	1-5		
IP Policy Routing (IPPR)		K	
Applying an IP Policy.....	38-6	Key Fields For Configuring Rules.....	12-3
Ethernet IP Policies.....	38-6		
Gateway	38-5	L	
IP Pool	5-3, 5-4, 25-3	LAN IP Address	20-7, 20-10
IP Pool Setup	5-1	LAN Port Filter Setup	25-1
IP Ports	11-4, 40-10, 40-11	LAN Setup.....	5-1, 8-1, 25-1, 25-2
IP Protocol	38-5	LAN TCP/IP.....	5-1
IP Routing Policy.....	38-4	LAN to WAN Rules	12-4
IP Routing Policy (IPPR).....	38-1	LAND.....	11-4, 11-6
Benefits.....	38-1	Local.....	9-1
Cost Savings	38-1	Log	34-5
Criteria	38-1	Log Descriptions	S-1
Load Sharing.....	38-1	Log Facility	34-8
Setup	38-2	Logging	1-6
IP Spoofing.....	11-4, 11-7	Login Name.....	See My Login Name
IP Static Route	29-1, 29-2	Login Screen.....	See Password
Active.....	29-2	Logs.....	20-1
Destination IP Address	29-2		
IP Subnet Mask.....	29-2	M	
		MAC Address.....	24-2
		MAC Address Filter Action	6-7, 25-10

MAC Address Filtering.....	6-6	Nailed-Up Connection	24-8, 28-6
MAC service data unit	6-5, 25-8	Nailed-Up Connections.....	28-8
Main Menu.....	22-3	NAT.....	3-4, 3-9, 9-6, 9-8, 24-10, 28-9, 32-15
Main Menu Commands.....	22-2	Applying NAT in the SMT Menus	30-1
Management Information Base (MIB).....	18-25	Configuring.....	30-4
Many to Many No Overload	See NAT	Definitions	9-1
Many to Many Overload	See NAT	Examples	30-10
Many to One	See NAT	How NAT Works.....	9-2
Maximum Incomplete High.....	12-27	Mapping Types	9-4
Maximum Incomplete Low.....	12-27	NAT Unfriendly Application Programs... ..	30-16
Max-incomplete High	12-25	Ordering Rules.....	30-7
Max-incomplete Low	12-25, 12-27	What NAT does	9-2
MD5	J-1	NAT Traversal.....	19-1, 19-2, 19-3
Mean Time Between Failures	B-1	NetBIOS commands	11-7
Message Digest Algorithm 5.....	See MD5	Network Address Translation	27-3
Metric.....	8-1, 10-4, 24-10, 28-6, 28-9, 29-2	Network Address Translation (NAT)	1-6, 30-1
MSDU.....	6-5, 25-8	Network Management	9-7
MTBF.....	See Mean Time Between Failures	Network Topology With RADIUS Server	
Multicast	5-2, 5-5, 24-11, 25-5, 28-10	Example	I-2
My IP Addr	28-7	NNTP.....	9-7
My Login	24-7, 28-3	Notice.....	iii
My Login Name.....	27-2		
My Password.....	24-7, 27-2, 28-3	O	
My Server IP Addr.....	28-7	Offline.....	23-4
My WAN Address	24-10	One Minute High.....	12-27
N		One Minute Low	12-27
Nailed-up Connection	28-5	One to One.....	See NAT
		One-Minute High.....	12-25
		Online Registration.....	v

Operation Temperature B-1
 Outgoing Protocol Filters..... 25-6
 Outside..... 9-1

P

Packet Filtering 1-4, 11-12
 Packet Filtering Firewalls 11-1
 Packing List Card xxxix
 PAP..... 24-7, 28-6
 Password 4-5, 22-2, 22-7, 33-1. See My Password
 PCMCIA Port 1-2
 Period(hr)..... 24-8, 28-6
 Ping..... 34-13
 Ping of Death 11-4
 Point-to-Point Tunneling Protocol.... 3-6, 9-7. See PPTP

Policy-based Routing..... 38-1
 POP3 9-7, 11-3, 11-4
 Port Configuration 12-15
 Port Forwarding 1-6
 Power Adaptor Specifications B-3
 Power Consumption..... B-1
 Power Current..... B-1
 Power Specification B-1
 PPP 24-8
 PPPoE 1-5, 3-2, 3-4
 PPPoE Encapsulation 27-1, 27-5, 28-2, 28-4, 28-5, 28-6, 28-11
 PPTP 3-2, 3-4, 3-6, 9-7, L-1

Client 27-3, 27-4
 Configuring a Client 27-3, 27-4
 PPTP Encapsulation 1-5, 3-6, 28-6
 Precedence..... 38-1, 38-5
 Private..... 10-4, 24-10, 28-9, 29-3
 Private IP Address 3-8
 Protocol Filters 25-6
 Incoming..... 25-6
 Outgoing..... 25-6
 Protocol/Port..... 20-7, 20-9
 Public Servers..... 7-1

Q

Quality of Service..... 38-1
 Quick Start Guide 2-1

R

RADIUS 1-4, 17-3
 Shared Secret Key 17-4
 RADIUS Message Types 17-3
 RAS 38-2
 Read Me First xxxix
 Real Time Chip 1-2
 Related Documentation xxxix
 Relay..... 25-3
 Rem IP Address..... 24-10
 Rem Node Name 24-6, 24-9, 28-3
 Remote Authentication Dial In User Service .. See RADIUS
 Remote Management..... 37-1

Remote Management and NAT	18-2	Rule Summary	12-21
Remote Management Limitations	18-2, 37-3	Rules	12-1, 12-4
Remote Node	28-1	Checklist	12-2
Profile (Traffic Redirect Field)	28-12	Creating Custom	12-1
Remote Node Filter	24-13, 28-10	Key Fields	12-3
Removing and Installing Fuses	D-1	LAN to WAN	12-4
Repairs	v	Logic	12-2
Replacement	v	Predefined Services	12-21
Reports	20-6	Source and Destination Addresses	12-14
Required fields	22-3		
Reset Button	1-2	S	
Resetting the Time	36-8	SA Monitor	41-1
Restore	21-9	Safety Instructions	C-1
Restore Configuration	35-8	Saving the State	11-7
retry count	24-5	Schedule Sets	
retry interval	24-5	Duration	39-2
Return Material Authorization Number	v	Schedules	28-6, 28-7
RF signals	H-2	Security Association	41-1
RIP	5-2, 24-11, 25-5, 25-6, 28-10	Security Ramifications	12-3
Direction	25-6	Select	See Syntax Conventions
Version	25-6, 28-10	Server...4-8, 9-5, 27-2, 28-4, 30-4, 30-6, 30-9, 30-10, 30-12, 30-13, 36-7	
RoadRunner Support	1-6	Server IP	28-4
Route	28-4	Service	v, 12-3
Routing Policy	38-1	Service Set	25-8
RTC..... See Real Time Chip. See Real Time Chip		Service Type	12-15, 27-2, 28-3, A-3
RTS Threshold	6-2	Services	9-6
RTS/CTS handshake	6-5, 25-8	Set Up a Schedule	39-2
		SMT	22-2. See System Management Terminal

SMT Menus at a Glance	22-5	SYN-ACK	11-5
SMTP	9-7	Syntax Conventions	xl
Smurf	11-6	Syslog	34-7
SNMP	9-7, 18-23	Syslog	12-17, 34-8
Community	33-1	Syslog IP Address	34-8
Configuration	33-1	System Information	34-1, 34-3, 34-4
Get	18-25	System Maintenance.20-3, 34-1, 34-2, 34-3, 34-4,	
Manager	18-24	34-5, 34-6, 34-7, 34-8, 34-11, 34-12, 34-13,	
MIBs	18-25	35-2, 35-5, 35-14, 35-16, 36-1, 36-3, 36-4, 36-	
Trap.....	18-25	5, 36-7	
Trusted Host	33-1	System Management Terminal	22-2
SNMP (Simple Network Management Protocol)		System Name.....	4-2, 23-2
.....	1-5	System Status	34-1
Source & Destination Addresses	12-14	System Timeout.....	18-2
Source Address	12-3, 12-11		
Source-Based Routing	38-1	T	
Stateful Inspection	1-3, 11-1, 11-2, 11-7, 11-8	TCP Maximum Incomplete ...	12-25, 12-26, 12-28
Process	11-8	TCP Security	11-10
ZyWALL	11-9	TCP/IP ...	5-4, 11-3, 11-4, 18-21, 24-9, 25-2, 25-4,
Static Route.....	10-1	26-2, 28-8, 32-6, 32-7, 32-9, 32-12, 32-15	
SUA	9-6, 9-7, 9-9	Setup.....	25-4
SUA (Single User Account) .. See NAT. See NAT		TCP/IP and DHCP Setup.....	25-2
Subnet Mask3-9, 5-2, 5-4, 12-14, 24-10, 25-5, 27-		TCP/IP filter rule	32-6
2, 28-9, 29-2		Teardrop	11-4
Subnet Masks.....	M-2	Telnet.....	18-20
Subnetting.....	M-2	Telnet Configuration	18-21
Support Disk	xxxix	Terminal Emulation.....	22-1
SYN Flood.....	11-4, 11-5	TFTP.....	35-5
		File Upload.....	35-14
		GUI-based Clients	35-6

TFTP and FTP over WAN	35-5	WAN Interface.....	A-3
TFTP and FTP over WAN Will Not Work When	35-5	Trusted Network	See LAN
TFTP and FTP Over WAN}	18-2, 37-3	TTLS.....	J-1
TFTP Restrictions	18-2, 35-5, 37-3	Tunneled Transport Layer Service.....	See TTLS
Three-Way Handshake.....	11-5	Type of Service.....	38-1, 38-3, 38-5
Threshold Values	12-24	U	
Time and Date.....	1-2	UDP/ICMP Security	11-10
Time and Date Setting.....	36-6, 36-7	Universal Plug and Play.....	1-4
Time Zone.....	4-7, 36-8	Universal Plug and Play (UPnP).....	19-1, 19-3
Timeout.....	24-8, 27-4, 27-5, 28-6	Upload Firmware	35-11
TLS	J-1	UPnP	1-4
ToS (Type of Service).....	38-1	UPnP Examples	19-5
Trace	34-5	Upper Layer Protocols.....	11-10, 11-11
Traceroute	11-7	Use Server Detected IP	23-4
Tracing	1-6	User Name	4-4, 23-4
Trademarks	ii	User Profiles	17-1
Traffic Redirect.....	1-6, 8-12, 8-13	User Specified IP Addr.....	23-4
Setup	28-12	V	
Transport Layer Security	See TLS	Virtual Private Network.....	1-3
Triangle.....	F-1	VPN	8-6
Triangle Route\ Solutions	F-2	VPN Application	1-9
Trigger Port Forwarding	30-18	VT100.....	22-1
Process	9-13	W	
Trivial File Transfer Protocol.....	See TFTP	WAN DHCP	34-12, 34-13
Troubleshooting	A-1	WAN Setup.....	3-9, 24-1
Internet Access.....	A-3	WAN to LAN Rules	12-4
LAN Interface	A-2	Warranty	v

Web..... 18-4
Web Configurator 2-1, 2-4, 11-2, 11-11, 12-3, 31-2
Web Site Hits..... 20-7, 20-8
WEP Encryption 6-5
Wireless LAN 1-2, H-1
 Benefits.....H-1
Wireless LAN MAC Address Filtering 1-4
Wireless LAN Setup 25-7
Wizard Setup 3-1, 3-2, 3-8
WLAN See Wireless LAN
www.dyndns.org..... 23-4

X

Xmodem
 File Upload.....35-17
XMODEM Protocol35-3

Z

ZyNOS 34-3, 34-5, 35-2
ZyNOS F/W Version..... 34-3, 34-5, 35-2
ZyWALL Firewall Application..... 11-3
ZyXEL Limited Warranty
 Note v
ZyXEL's Firewall
 Introduction 11-2