

Dimension ***GS-3012***

Gigabit Ethernet Switch

Version 3.50(LH.0)

7/2005

User's Guide

ZyXEL

Copyright

Copyright © 2004 by ZyXEL Communications Corporation

The contents of this publication may not be reproduced in any part or as a whole, transcribed, stored in a retrieval system, translated into any language, or transmitted in any form or by any means, electronic, mechanical, magnetic, optical, chemical, photocopying, manual, or otherwise, without the prior written permission of ZyXEL Communications Corporation.

Published by ZyXEL Communications Corporation. All rights reserved.

Disclaimer

ZyXEL does not assume any liability arising out of the application or use of any products, or software described herein. Neither does it convey any license under its patent rights nor the patents rights of others. ZyXEL further reserves the right to make changes in any products described herein without notice. This publication is subject to change without notice.

Trademarks

Trademarks mentioned in this publication are used for identification purposes only and may be properties of their respective owners.

ZyXEL Limited Warranty

ZyXEL warrants to the original end user (purchaser) that this product is free from any defects in materials or workmanship for a period of up to two (2) years from the date of purchase. During the warranty period and upon proof of purchase, should the product have indications of failure due to faulty workmanship and/or materials, ZyXEL will, at its discretion, repair or replace the defective products or components without charge for either parts or labor and to whatever extent it shall deem necessary to restore the product or components to proper operating condition. Any replacement will consist of a new or re-manufactured functionally equivalent product of equal value, and will be solely at the discretion of ZyXEL. This warranty shall not apply if the product is modified, misused, tampered with, damaged by an act of God, or subjected to abnormal working conditions.

Note

Repair or replacement, as provided under this warranty, is the exclusive remedy of the purchaser. This warranty is in lieu of all other warranties, express or implied, including any implied warranty of merchantability or fitness for a particular use or purpose. ZyXEL shall in no event be held liable for indirect or consequential damages of any kind of character to the purchaser.

To obtain the services of this warranty, contact ZyXEL's Service Center for your Return Material Authorization number (RMA). Products must be returned Postage Prepaid. It is recommended that the unit be insured when shipped. Any returned products without proof of purchase or those with an out-dated warranty will be repaired or replaced (at the discretion of ZyXEL) and the customer will be billed for parts and labor. All repaired or replaced products will be shipped by ZyXEL to the corresponding return address, Postage Paid. This warranty gives you specific legal rights, and you may also have other rights that vary from country to country.

Interference Statements and Warnings

FCC Interference Statement

This switch complies with Part 15 of the FCC rules. Operation is subject to the following two conditions:

- (1) This switch may not cause harmful interference.
- (2) This switch must accept any interference received, including interference that may cause undesired operations.

FCC Warning

This equipment has been tested and found to comply with the limits for a Class A digital switch, pursuant to Part 15 of the FCC Rules. These limits are designed to provide reasonable protection against harmful interference in a commercial environment. This equipment generates, uses, and can radiate radio frequency energy and, if not installed and used in accordance with the instruction manual, may cause harmful interference to radio communications. Operation of this equipment in a residential area is likely to cause harmful interference in which case the user will be required to correct the interference at his own expense.

CE Mark Warning:

This is a class A product. In a domestic environment this product may cause radio interference in which case the user may be required to take adequate measures.

Taiwanese BSMI (Bureau of Standards, Metrology and Inspection) A Warning:

警告使用者

這是甲類的資訊產品, 在居住的環境使用時,
可能造成射頻干擾, 在這種情況下,
使用者會被要求採取某些適當的對策.

Certifications

Go to www.zyxel.com

Select your product from the drop-down list box on the ZyXEL home page to go to that product's page.

Select the certification you wish to view from this page.

Registration

Register your product online for free future product updates and information at www.zyxel.com for global products, or at www.us.zyxel.com for North American products.

Customer Support

If you have questions about your ZyXEL product or desire assistance, contact ZyXEL Communications Corporation offices worldwide, in one of the following ways:

Contacting Customer Support

When you contact your customer support representative, have the following information ready:

- ◆ Product model and serial number.
- ◆ Firmware version information.
- ◆ Warranty information.
- ◆ Date you received your product.
- ◆ Brief description of the problem and the steps you took to solve it.

METHOD LOCATION	SUPPORT E-MAIL SALES E-MAIL	TELEPHONE ¹ FAX ¹	WEB SITE FTP SITE	REGULAR MAIL
CORPORATE HEADQUARTERS (WORLDWIDE)	support@zyxel.com.tw sales@zyxel.com.tw	+886-3-578-3942 +886-3-578-2439	www.zyxel.com www.europe.zyxel.com ftp.zyxel.com ftp.europe.zyxel.com	ZyXEL Communications Corp. 6 Innovation Road II Science Park Hsinchu 300 Taiwan
CZECH REPUBLIC	info@cz.zyxel.com info@cz.zyxel.com	+420 241 091 350 +420 241 091 359	www.zyxel.cz	ZyXEL Communications Czech s.r.o. Modranská 621 143 01 Praha 4 – Modrany Česká Republika
DENMARK	support@zyxel.dk sales@zyxel.dk	+45 39 55 07 00 +45 39 55 07 07	www.zyxel.dk	ZyXEL Communications A/S Columbusvej 5 2860 Soeborg Denmark
FINLAND	support@zyxel.fi sales@zyxel.fi	+358-9-4780-8411 +358-9-4780 8448	www.zyxel.fi	ZyXEL Communications Oy Malminkaari 10 00700 Helsinki Finland
FRANCE	info@zyxel.fr	+33 (0)4 72 52 97 97 +33 (0)4 72 52 19 20	www.zyxel.fr	ZyXEL France 1 rue des Vergers Bat. 1 / C 69760 Limonest France
GERMANY	support@zyxel.de sales@zyxel.de	+49-2405-6909-0 +49-2405-6909-99	www.zyxel.de	ZyXEL Deutschland GmbH, Adenauerstr. 20/A2 D-52146 Wuerselen Germany
NORTH AMERICA	support@zyxel.com sales@zyxel.com	+1-800-255-4101 +1-714-632-0882 +1-714-632-0858	www.us.zyxel.com ftp.us.zyxel.com	ZyXEL Communications Inc. 1130 N. Miller St. Anaheim CA 92806-2001 U.S.A.
NORWAY	support@zyxel.no sales@zyxel.no	+47 22 80 61 80 +47 22 80 61 81	www.zyxel.no	ZyXEL Communications A/S Nils Hansens vei 13 0667 Oslo Norway

¹ “+” is the (prefix) number you enter to make an international telephone call.

Dimension GS-3012 Gigabit Ethernet Switch

METHOD LOCATION	SUPPORT E-MAIL SALES E-MAIL	TELEPHONE ¹ FAX ¹	WEB SITE FTP SITE	REGULAR MAIL
SPAIN	support@zyxel.es sales@zyxel.es	+34 902 195 420 +34 913 005 345	www.zyxel.es	ZyXEL Communications Alejandro Villegas 33 1º, 28043 Madrid Spain
SWEDEN	support@zyxel.se sales@zyxel.se	+46 31 744 7700 +46 31 744 7701	www.zyxel.se	ZyXEL Communications A/S Sjöporten 4, 41764 Göteborg Sweden
UNITED KINGDOM	support@zyxel.co.uk sales@zyxel.co.uk	+44 (0) 1344 303044 (UK only) 08707 555779 +44 (0) 1344 303034	www.zyxel.co.uk ftp.zyxel.co.uk	ZyXEL Communications UK Ltd., 11 The Courtyard, Eastern Road, Bracknell, Berkshire, RG12 2XB, United Kingdom (UK)

Table of Contents

Copyright	ii
ZyXEL Limited Warranty.....	iii
Interference Statements and Warnings	iv
Customer Support	v
List of Figures.....	xiii
List of Tables.....	xvii
Preface	xix
Part I.....	I
Chapter 1 Getting to Know the GS-3012	1-1
1.1 Introduction.....	1-1
1.2 Features	1-1
1.3 Applications	1-3
Part II.....	II
Chapter 2 Hardware Installation.....	2-1
2.1 Installation Scenarios	2-1
Chapter 3 Hardware Connections	3-1
3.1 Safety Warnings	3-1
3.2 Front Panel	3-1
3.3 Rear Panel.....	3-5
3.4 Front Panel LEDs	3-6
3.5 Configuring the GS-3012.....	3-7
Part III.....	III
Chapter 4 Introducing the Web Configurator	4-1
4.1 Introduction.....	4-1
4.2 System Login.....	4-1
4.3 Status Screen	4-1
4.4 Switch Lockout	4-6
4.5 Resetting the Switch.....	4-6
Chapter 5 System Status and Port Details	5-1
5.1 About System Statistics and Information	5-1
5.2 Port Status Summary	5-1

Chapter 6	Basic Setting	6-1
6.1	Introducing the Basic Setting Screens.....	6-1
6.2	System Information.....	6-1
6.3	General Setup.....	6-3
6.4	Introduction to VLANs.....	6-5
6.5	IGMP Snooping	6-6
6.6	Switch Setup Screen	6-6
6.7	IP Setup	6-9
6.8	Port Setup.....	6-11
Part IV	IV
Chapter 7	VLAN.....	7-1
7.1	Introduction to IEEE 802.1Q Tagged VLAN	7-1
7.2	802.1Q VLAN.....	7-3
7.3	Introduction to Port-based VLANs	7-9
Chapter 8	Static MAC Forward Setup	8-1
8.1	Introduction to Static MAC Forward Setup	8-1
8.2	Configuring Static MAC Forwarding	8-1
8.3	Viewing and Editing Static MAC Forwarding Rules.....	8-2
Chapter 9	Filtering	9-1
9.1	Introduction to Filtering	9-1
9.2	Configuring a Filtering Rule	9-1
9.3	Viewing and Editing Filter Rules.....	9-2
Chapter 10	Spanning Tree Protocol	10-1
10.1	Introduction to Spanning Tree Protocol (STP)	10-1
10.2	STP Status.....	10-2
Chapter 11	Bandwidth Control	11-1
11.1	Introduction to Bandwidth Control	11-1
Part V	V
Chapter 12	Broadcast Storm Control	12-1
12.1	Introducing Broadcast Storm Control	12-1
12.2	Configuring Broadcast Storm Control.....	12-1
Chapter 13	Mirroring.....	13-1

13.1	Introduction to Port Mirroring.....	13-1
13.2	Port Mirroring Configuration	13-1
Chapter 14	Link Aggregation.....	14-1
14.1	Introduction to Link Aggregation.....	14-1
14.2	Link Aggregation Protocol Status	14-2
14.3	Link Aggregation Setup	14-3
Chapter 15	Port Authentication	15-1
15.1	Introduction to Authentication.....	15-1
15.2	Configuring Port Authentication.....	15-1
Chapter 16	Port Security	16-1
16.1	About Port Security	16-1
16.2	Port Security Setup.....	16-1
Chapter 17	Access Control	17-1
17.1	About Access Control.....	17-1
17.2	Access Control Overview	17-1
17.3	About SNMP	17-2
17.4	SSH Overview	17-5
17.5	How SSH works.....	17-6
17.6	SSH Implementation	17-6
17.7	Introduction to HTTPS.....	17-7
17.8	Service Access Control	17-10
17.9	Remote Management.....	17-11
Chapter 18	Queuing Method	18-1
18.1	Introduction to Queuing	18-1
18.2	Configuring Queuing	18-2
Chapter 19	Classifier	19-1
19.1	About the Classifier and QoS	19-1
19.2	Configuring the Classifier	19-1
19.3	Viewing and Editing Classifier Configuration	19-4
19.4	Classifier Example.....	19-5
Chapter 20	Policy Rule.....	20-1
20.1	About Policy Rules	20-1

Dimension GS-3012 Gigabit Ethernet Switch

20.2	Configuring Policy Rules	20-1
20.3	Viewing and Editing Policy Configuration	20-4
20.4	Policy Example	20-5
Chapter 21	DHCP Relay	21-1
21.1	Overview	21-1
21.2	DHCP Relay Configuration	21-1
Part VI	VI
Chapter 22	Routing Protocol	22-1
22.1	Static Route	22-1
Chapter 23	Maintenance	23-1
23.1	Maintenance	23-1
23.2	Firmware Upgrade	23-1
23.3	Restore a Configuration File	23-2
23.4	Backing Up a Configuration File	23-2
23.5	Load Factory Defaults	23-3
23.6	Reboot System	23-3
23.7	Command Line FTP	23-3
Chapter 24	Diagnostic	24-1
24.1	Diagnostic	24-1
Chapter 25	Cluster Management	25-1
25.1	Introduction to Cluster Management	25-1
25.2	Cluster Management Status	25-2
25.3	Configuring Cluster Management	25-4
Chapter 26	MAC Table	26-1
26.1	Introduction to MAC Table	26-1
26.2	Viewing MAC Table	26-2
Chapter 27	ARP Table	27-1
27.1	Introduction to ARP Table	27-1
27.2	Viewing ARP Table	27-1
Part VII	VII
Chapter 28	Introducing the Commands	28-1
28.1	Overview	28-1

28.2	Accessing the CLI.....	28-1
28.3	The Login Screen.....	28-2
28.4	Command Syntax Conventions.....	28-3
28.5	Getting Help.....	28-3
28.6	Command Modes.....	28-5
28.7	Using Command History.....	28-5
28.8	Saving Your Configuration.....	28-5
28.9	Command Summary.....	28-6
Chapter 29	Command Examples.....	29-1
29.1	Overview.....	29-1
29.2	show Commands.....	29-1
29.3	ping.....	29-4
29.4	traceroute.....	29-4
29.5	Enabling RSTP.....	29-5
29.6	Configuration File Maintenance.....	29-5
29.7	Example no Commands.....	29-7
29.8	interface Commands.....	29-10
Chapter 30	IEEE 802.1Q Tagged VLAN Commands.....	30-1
30.1	IEEE 802.1Q Tagged VLAN Overview.....	30-1
30.2	VLAN Databases.....	30-1
30.3	Configuring Tagged VLAN.....	30-1
30.4	Global VLAN1Q Tagged VLAN Configuration Commands.....	30-2
30.5	Port VLAN Commands.....	30-4
30.6	Enable VLAN.....	30-7
30.7	Disable VLAN.....	30-7
30.8	Show VLAN Setting.....	30-7
Part VIII	VIII
A	Product Specifications.....	A-1
B	Index.....	1

List of Figures

Figure 1-1 Backbone Application	1-4
Figure 1-2 Bridging Application	1-5
Figure 1-3 High Performance Switched Workgroup Application	1-6
Figure 1-4 VLAN Workgroup Application	1-7
Figure 1-5 Shared Server Using VLAN Example	1-8
Figure 2-1 Attaching Rubber Feet	2-1
Figure 2-2 Attaching Mounting Brackets and Screws	2-2
Figure 2-3 Mounting the ES to an EIA standard 19-inch rack	2-2
Figure 3-1 GS-3012 Front Panel	3-1
Figure 3-2 Transceiver Installation Example	3-3
Figure 3-3 Installed Transceiver	3-4
Figure 3-4 Opening the Transceiver's Latch Example	3-4
Figure 3-5 Transceiver Removal Example	3-5
Figure 3-6 GS-3012 Rear Panel: AC Model	3-5
Figure 3-7 GS-3012 Rear Panel: DC Model	3-5
Figure 3-8 Front Panel LEDs	3-6
Figure 4-1 Web Configurator: login	4-1
Figure 4-2 Web Configurator Home Screen (Status)	4-2
Figure 4-3 Web Configurator: Change Password at Login	4-6
Figure 4-4 Resetting the Switch: Via Console Port	4-7
Figure 4-5 Web Configurator: Logout Screen	4-7
Figure 5-1 Status	5-1
Figure 5-2 Status: Port Details	5-3
Figure 6-1 System Info	6-2
Figure 6-2 General Setup	6-4
Figure 6-3 Switch Setup	6-7
Figure 6-4 IP Setup	6-9
Figure 6-5 Port Setup	6-12
Figure 7-1 Port VLAN Trunking	7-3
Figure 7-2 Selecting a VLAN Type	7-3
Figure 7-3 802.1Q VLAN Status	7-4
Figure 7-4 802.1Q VLAN Port Settings	7-5
Figure 7-5 802.1Q Static VLAN	7-7
Figure 7-6 Static VLAN: Summary Table	7-8
Figure 7-7 VID1 Example Screen	7-9
Figure 7-8 Port Based VLAN Setup (All Connected)	7-10
Figure 7-9 Port Based VLAN Setup (Port isolation)	7-11
Figure 8-1 Static MAC Forwarding	8-1
Figure 8-2 Static MAC Forwarding: Summary Table	8-2
Figure 9-1 Filtering	9-1
Figure 9-2 Filtering: Summary Table	9-2
Figure 10-1 Spanning Tree Protocol: Status	10-3
Figure 10-2 Spanning Tree Protocol: Configuration	10-4

Figure 11-1 Bandwidth Control	11-1
Figure 12-1 Broadcast Storm Control	12-1
Figure 13-1 Mirroring	13-1
Figure 14-1 Aggregation ID	14-2
Figure 14-2 Link Aggregation: Link Aggregation Protocol Status	14-2
Figure 14-3 Link Aggregation: Configuration	14-4
Figure 15-1 RADIUS Server	15-1
Figure 15-2 Port Authentication	15-1
Figure 15-3 Port Authentication: RADIUS	15-2
Figure 15-4 Port Authentication: 802.1x	15-3
Figure 16-1 Port Security	16-1
Figure 17-1 Access Control	17-1
Figure 17-2 Console Port Priority	17-1
Figure 17-3 SNMP Management Model	17-2
Figure 17-4 Access Control: SNMP	17-4
Figure 17-5 Access Control: Logins	17-5
Figure 17-6 SSH Communication Example	17-6
Figure 17-7 How SSH Works	17-6
Figure 17-8 HTTPS Implementation	17-7
Figure 17-9 Security Alert Dialog Box (Internet Explorer)	17-8
Figure 17-10 Security Certificate 1 (Netscape)	17-9
Figure 17-11 Security Certificate 2 (Netscape)	17-9
Figure 17-12 Main Screen (Internet Explorer)	17-10
Figure 17-13 Main Screen (Netscape)	17-10
Figure 17-14 Access Control: Service Access Control	17-11
Figure 17-15 Access Control: Remote Management	17-11
Figure 18-1 Queuing Method	18-2
Figure 19-1 Classifier	19-2
Figure 19-2 Classifier: Summary Table	19-4
Figure 19-3 Classifier: Example	19-6
Figure 20-1 Policy	20-2
Figure 20-2 Policy: Summary Table	20-4
Figure 20-3 Policy Example	20-6
Figure 21-1 DHCP Relay	21-2
Figure 22-1 Static Routing	22-1
Figure 22-2 Static Routing: Summary Table	22-2
Figure 23-1 Maintenance	23-1
Figure 23-2 Firmware Upgrade	23-1
Figure 23-3 Restore Configuration	23-2
Figure 23-4 Backup Configuration	23-2
Figure 23-5 Confirm Load factory Defaults	23-3
Figure 23-6 Restart Switch After Load Factory Defaults	23-3
Figure 23-7 Confirm Restart The Switch	23-3
Figure 24-1 Diagnostic	24-1
Figure 25-1 Clustering Application Example	25-1

Figure 25-2 Cluster Management Status	25-2
Figure 25-3 Cluster Member Web Configuration Screen	25-3
Figure 25-4 Example: Uploading Firmware to a Cluster Member Switch	25-4
Figure 25-5 Configuring Cluster Management	25-5
Figure 26-1 MAC Table Flowchart	26-1
Figure 26-2 MAC Table	26-2
Figure 27-1 ARP Table	27-2
Figure 28-1 Initial Console Port Screen	28-2
Figure 28-2 CLI: Login Screen	28-3
Figure 28-3 CLI Help: List of Commands: Example 1	28-4
Figure 28-4 CLI Help: List of Commands: Example 2	28-4
Figure 28-5 CLI Help: Detailed Command Information: Example 1	28-4
Figure 28-6 CLI: Help: Detailed Command Information: Example 2	28-4
Figure 28-7 CLI: History Command Example	28-5
Figure 28-8 CLI: write memory	28-5
Figure 29-1 show system-information Command Example	29-1
Figure 29-2 show hardware-monitor Command Example	29-2
Figure 29-3 show ip Command Example	29-2
Figure 29-4 show logging Command Example	29-3
Figure 29-5 show interface Command Example	29-3
Figure 29-6 show mac address-table Command Example	29-4
Figure 29-7 ping Command Example	29-4
Figure 29-8 traceroute Command Example	29-5
Figure 29-9 Enable RSTP Command Example	29-5
Figure 29-10 CLI: Backup Configuration Example	29-6
Figure 29-11 CLI: Restore Configuration Example	29-6
Figure 29-12 CLI: boot config Command Example	29-7
Figure 29-13 CLI: reload config Command Example	29-7
Figure 29-14 CLI: Reset to the Factory Default Example	29-7
Figure 29-15 no mirror-port Command Example	29-8
Figure 29-16 no https timeout Command Example	29-8
Figure 29-17 no trunk Command Example	29-9
Figure 29-18 no port-access-authenticator Command Example	29-9
Figure 29-19 no ssh Command Example	29-10
Figure 29-20 interface Command Example	29-10
Figure 29-21 interface bpd-control Command Example	29-11
Figure 29-22 broadcast-limit Command Example	29-11
Figure 29-23 bandwidth-limit Command Example	29-12
Figure 29-24 mirror Command Example	29-12
Figure 29-25 gvrp Command Example	29-13
Figure 29-26 ingress-check Command Example	29-13
Figure 29-27 frame-type Command Example	29-14
Figure 29-28 vlan-trunking Command Example	29-14
Figure 29-29 spq Command Example	29-15
Figure 29-30 wrr Command Example	29-15

Dimension GS-3012 Gigabit Ethernet Switch

Figure 29-31 egress set Command Example	29-15
Figure 29-32 qos priority Command Example	29-16
Figure 29-33 name Command Example	29-16
Figure 29-34 speed-duplex Command Example	29-17
Figure 30-1 Tagged VLAN Configuration and Activation Example	30-2
Figure 30-2 CPU VLAN Configuration and Activation Example	30-2
Figure 30-3 GARP STATUS Command Example	30-3
Figure 30-4 garp status Command Example	30-4
Figure 30-5 vlan1q port default vid Command Example	30-4
Figure 30-6 frame type Command Example	30-5
Figure 30-7 no gvrp Command Example	30-5
Figure 30-8 Modifying Static VLAN Example	30-6
Figure 30-9 no vlan Command Example	30-7
Figure 30-10 show vlan Command Example	30-8

List of Tables

Table 3-1 GS-3012: Front Panel	3-1
Table 3-2 Front Panel LED Descriptions	3-6
Table 4-1 Navigation Panel Sub-links Overview	4-3
Table 4-2 Web Configurator Screen Sub-links Details	4-3
Table 4-3 Navigation Panel Sub-link Descriptions	4-4
Table 5-1 Status.....	5-1
Table 5-2 Status: Port Details	5-3
Table 6-1 System Info.....	6-2
Table 6-2 General Setup	6-4
Table 6-3 Switch Setup.....	6-7
Table 6-4 IP Setup.....	6-9
Table 6-5 Port Setup.....	6-12
Table 7-1 GARP Terminology	7-2
Table 7-2 802.1Q VLAN Status	7-4
Table 7-3 802.1Q VLAN Port Settings.....	7-5
Table 7-4 802.1Q Static VLAN.....	7-7
Table 7-5 Static VLAN: Summary Table	7-8
Table 7-6 Port Based VLAN Setup.....	7-11
Table 8-1 Static MAC Forwarding.....	8-1
Table 8-2 Static MAC Forwarding: Summary Table.....	8-2
Table 9-1 Filtering.....	9-1
Table 9-2 Filtering: Summary Table.....	9-2
Table 10-1 STP Path Costs	10-1
Table 10-2 STP Port States	10-2
Table 10-3 Spanning Tree Protocol: Status	10-3
Table 10-4 Spanning Tree Protocol: Configuration.....	10-5
Table 11-1 Bandwidth Control	11-1
Table 12-1 Broadcast Storm Control	12-2
Table 13-1 Mirroring	13-2
Table 14-1 Link Aggregation: Link Aggregation Protocol Status	14-3
Table 14-2 Link Aggregation: Configuration	14-4
Table 15-1 Port Authentication: RADIUS.....	15-2
Table 15-2 Port Authentication: 802.1x	15-3
Table 16-1 Port Security	16-2
Table 17-1 Access Control Summary	17-1
Table 17-2 SNMP Commands.....	17-3
Table 17-3 SNMP Traps	17-3
Table 17-4 Access Control: SNMP	17-4
Table 17-5 Access Control: Logins.....	17-5
Table 17-6 Access Control: Service Access Control	17-11
Table 17-7 Access Control: Remote Management.....	17-12
Table 18-1 Physical Queue Priority	18-1
Table 18-2 Queuing Method	18-2

Dimension GS-3012 Gigabit Ethernet Switch

Table 19-1 Classifier	19-2
Table 19-2 Classifier: Summary Table	19-4
Table 19-3 Common Ethernet Types and Protocol Number	19-4
Table 19-4 Common IP Ports	19-5
Table 20-1 Policy	20-2
Table 20-2 Policy: Summary Table	20-4
Table 21-1 DHCP Relay	21-2
Table 22-1 Static Routing	22-1
Table 22-2 Static Routing: Summary Table	22-2
Table 23-1 Filename Conventions	23-4
Table 23-2 General Commands for GUI-based FTP Clients	23-5
Table 24-1 Diagnostic	24-1
Table 25-1 ZyXEL Clustering Management Specifications	25-1
Table 25-2 Cluster Management Status	25-2
Table 25-3 FTP Upload to Cluster member Example	25-4
Table 25-4 Configuring Cluster Management	25-5
Table 26-1 MAC Table	26-2
Table 27-1 ARP Table	27-2
Table 28-1 Command Summary: User Mode	28-6
Table 28-2 Command Summary: Enable Mode	28-7
Table 28-3 Command Summary: Configure Mode	28-10
Table 28-4 Command Summary: config-vlan Commands	28-19
Table 28-5 Command Summary: Interface	28-21

Preface

Congratulations on your purchase from the Dimension series of switches.

This preface introduces you to the GS-3012 and discusses the conventions of this User's Guide. It also provides information on other related documentation.

About the GS-3012

There are two GS-3012 models. The GS-3012 DC model requires DC power supply input of -48 VDC to -60 VDC, 1.84A Max. The GS-3012 AC model requires 100~240VAC/1.5A power.

All figures in this guide display the GS-3012 AC model unless specifically noted otherwise.

The GS-3012 Gigabit Ethernet Switch is a managed switch with features ideally suited in an enterprise environment. It can deliver broadband IP services to:







- Multi-tenant unit (MTU) buildings (hotels, motels, resorts, residential multi-dwelling units, office buildings, educational establishments, etc.)
- Public facilities (convention centers, airports, plazas, train stations, etc.)
- Enterprises.

It can also be deployed as a mini-POP (point-of-presence) in a building basement delivering 10/100/1000Mbps data service over Category 5 wiring to each customer.

General Syntax Conventions

- This guide shows you how to configure the switch using the web configurator and CLI commands. See the online HTML help for information on individual web configurator screens.
- Mouse action sequences are denoted using a comma. For example, click **Start, Settings, Control Panel, Network** means first you click **Start**, click or move the mouse pointer over **Settings**, then click or move the mouse pointer over **Control Panel** and finally click (or double-click) **Network**.
- “Enter” means for you to type one or more characters. “Select” or “Choose” means for you to use one of the predefined choices.
- Predefined choices are in **Bold Arial** font.
- Button and field labels, links and screen names in are in **Bold Times New Roman** font.
- For brevity's sake, we will use “e.g.” as shorthand for “for instance”, and “i.e.” as shorthand for “that is” or “in other words” throughout this manual.
- The ZyXEL Dimension GS-3012 Gigabit Ethernet Switch will be referred to as the “GS-3012”, the “GS” or, simply, as “the switch” in this User's Guide.

Graphics Icons Key

 The GS	 Switch	 Server
 Computer	 Printer	 Gateway

Related Documentation

Web Configurator Online HTML help

The online HTML help shows you how to use the web configurator to configure individual screens. More background information can be found in this UG.

ZyXEL Web Site

The ZyXEL download library at www.zyxel.com contains additional support documentation as well as an online glossary of networking terms.

User Guide Feedback

Help us help you. E-mail all User Guide-related comments, questions or suggestions for improvement to techwriters@zyxel.com.tw or send regular mail to The Technical Writing Team, ZyXEL Communications Corp., 6 Innovation Road II, Science-Based Industrial Park, Hsinchu, 300, Taiwan. Thank you.

Part I

Features and Applications

This part acquaints you with the features and applications of the GS-3012.

Chapter 1 Getting to Know the GS-3012

This chapter describes the key features, benefits and applications of the GS-3012.

1.1 Introduction

The GS-3012 is a layer 2 stand-alone Gigabit Ethernet switch with 12 10/100/1000Mbps ports, four mini GBIC slots for optical uplinking and one console port and RJ-45 port for local management.

With its built-in web configurator, managing and configuring the switch is easy. From cabinet management to port-level control and monitoring, you can visually configure and manage your network via the web browser. Just click your mouse instead of typing cryptic command strings. In addition, the switch can also be managed via Telnet, the console port, or third-party SNMP management.

1.2 Features

The next two sections describe the hardware and firmware features of the GS-3012.

1.2.1 Hardware Features

Power

The GS-3012 DC model requires DC power supply input of -48 VDC to -60 VDC, 1.84A Max. The GS-3012 AC model requires 100~240VAC/1.5A power.

12 10/100/1000 Mbps Gigabit Ports (with four paired with the mini GBIC ports)

Connect up to 12 computers or switches directly to the 10/100/1000Mbps auto-negotiating, automatic cable sensing (auto-MDIX) Gigabit ports. All ports support:

- IEEE 802.3/3u/3z/3ab standards
- Back pressure flow control in half duplex mode
- IEEE 802.3x flow control in full duplex mode

Four Mini GBIC Slots

These are slots for mini GBIC (Gigabit Interface Converter) transceiver. These allow the GS-3012 to connect to another WAN switch or daisy-chain to other switches.

Console Port

Use the console port for local management of the switch.

One Management Port

Use the RJ-45 management port for switch management only. The management port is out-of-band, meaning that it does not carry switch traffic.

Fans

The fans cool the GS-3012 sufficiently to allow reliable operation of the switch in even poorly ventilated rooms or basements.

1.2.2 Firmware Features

IP Protocols

- IP Host (No routing)
- Telnet for configuration and monitoring
- SNMP for management
 - SNMP MIB II (RFC 1213)
 - SNMP v1 RFC 1157
 - Ethernet MIBs RFC 1643
 - Bridge MIBs RFC 1493
 - SMI RFC 1155
 - RMON RFC 1757
 - SNMPv2 or SNMPv2c
 - Bridge extension MIBs RFC 2674
 - Interface MIB RFC 2863
 - Ping and Trace Route RFC 2925

Management

- Web configurator
- Command-line interface locally via console port or remotely via Telnet
- Out-of-band RJ-45 management port
- SNMP

System Monitoring

- System status (link status, rates, statistics counters)
- SNMP
- Temperatures, voltage, fan speed reports and alarms
- Port Mirroring allows you to analyze one port's traffic from another.

Security

- System management password protection
- IEEE 802.1Q VLAN
- Limit dynamic port MAC address learning
- Secure SHell communication protocol
- Port-based VLAN
- 802.1x Authentication
- Static MAC address filtering

Port Link Aggregation

The GS-3012 adheres to the 802.3ad standard for static and dynamic port link aggregation.

Bandwidth Control

- The GS-3012 supports rate limiting in 1Mbps increments allowing you to create different service plans
- The GS-3012 supports IGMP snooping enabling group multicast traffic to be only forwarded to ports that are members of that group; thus allowing you to significantly reduce multicast traffic passing through your switch.
- Broadcast storm control

Quality of Service

- Eight priority queues so you can ensure mission-critical data gets delivered on time.
- Follows the IEEE 802.1p priority setting.
- Advanced policy-based traffic shaping.

STP (Spanning Tree Protocol) / RSTP (Rapid STP)

(R)STP detects and breaks network loops and provides backup links between switches, bridges or routers. It allows a switch to interact with other (R)STP -compliant switches in your network to ensure that only one path exists between any two stations on the network.

Cluster Management

Cluster Management allows you to manage switches through one switch, called the cluster manager. The switches must be directly connected and be in the same VLAN group so as to be able to communicate with one another.

1.3 Applications

This section shows a few examples of using the GS-3012 in various network environments.

1.3.1 Backbone Application

In this application, the switch is an ideal solution for small networks where rapid growth can be expected in the near future.

The switch can be used standalone for a group of heavy traffic users. You can connect computers directly to the switch's ports or connect other switches to the GS-3012.

In this example, all computers connected directly or indirectly to the GS-3012 can share super high-speed applications on the Gigabit server.

To expand the network, simply add more networking devices such as switches, routers, firewalls, print servers etc.

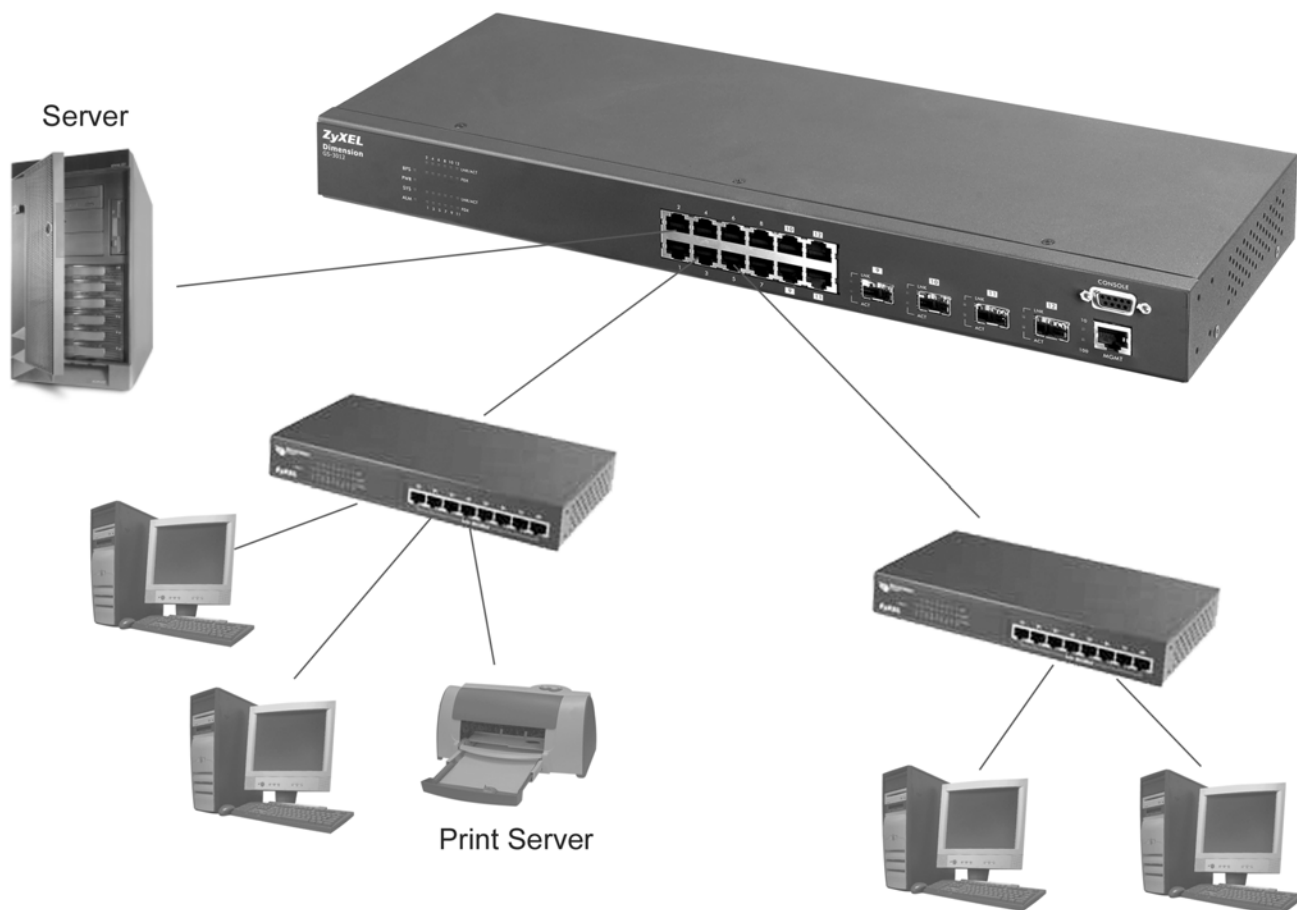

Figure 1-1 Backbone Application

1.3.2 Bridging Example

In this example application the switch is the ideal solution for different company departments to connect to the corporate backbone. It can alleviate bandwidth contention and eliminate server and network bottlenecks. All users that need high bandwidth can connect to high-speed department servers via the switch. You can provide a super-fast uplink connection by installing the transceiver(s) in the mini GBIC slots on the GS-3012.

Moreover, the switch eases supervision and maintenance by allowing network managers to centralize multiple servers at a single location.

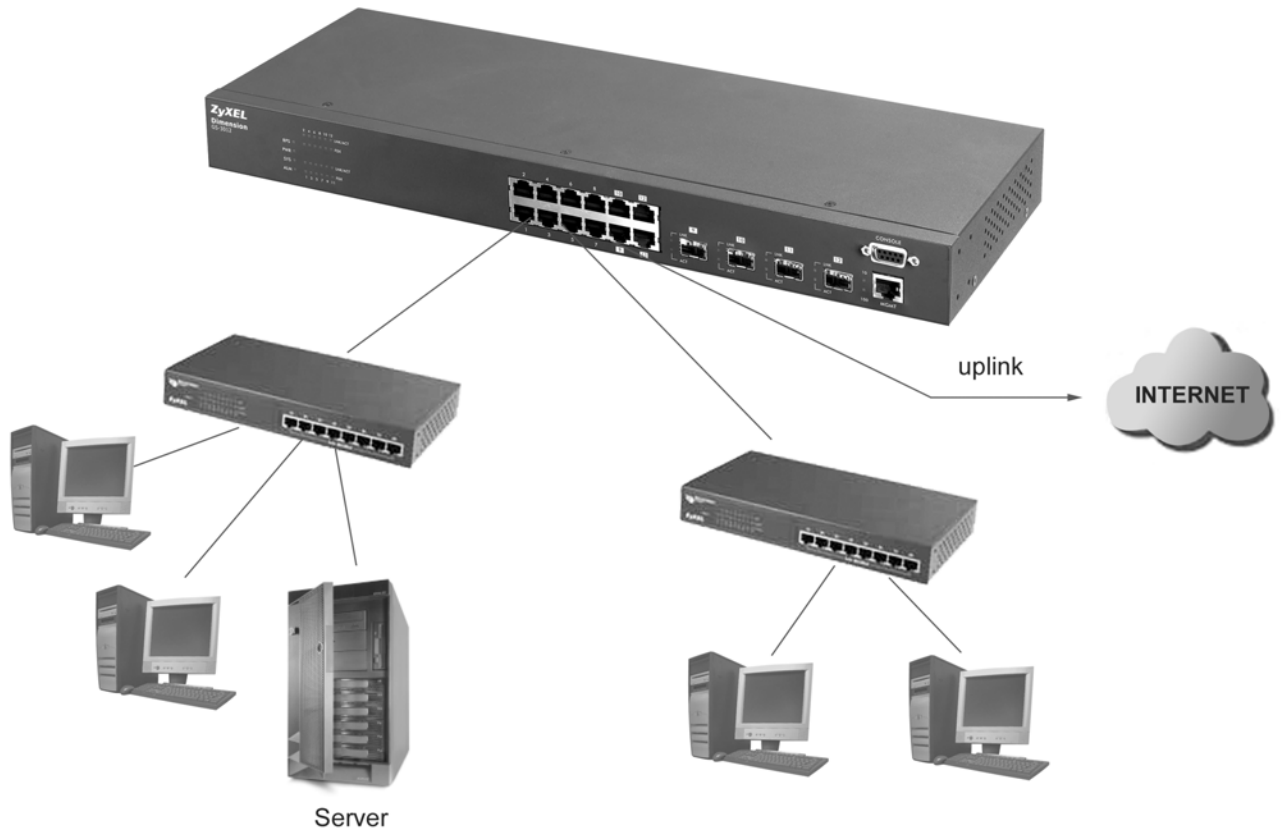

Figure 1-2 Bridging Application

Full-duplex mode operation only applies to point-to-point access (for example, when attaching the switch to a workstation, server, or another switch). When connecting to hubs, use a standard cascaded connection set at half-duplex operation.

1.3.3 High Performance Switched Workgroup Example

The switch is ideal for connecting two power workgroups that need high bandwidth. In the following example, use trunking to connect these two power workgroups.

Switching to higher-speed LANs such as FDDI or ATM is not feasible for most people due to the expense of replacing all existing Ethernet cables and adapter cards, restructuring your network and complex maintenance.

The GS-3012 can provide the same bandwidth as FDDI and ATM at much lower cost while still being able to use existing adapters and switches. Moreover, the current LAN structure can be retained as all ports can freely communicate with each other.

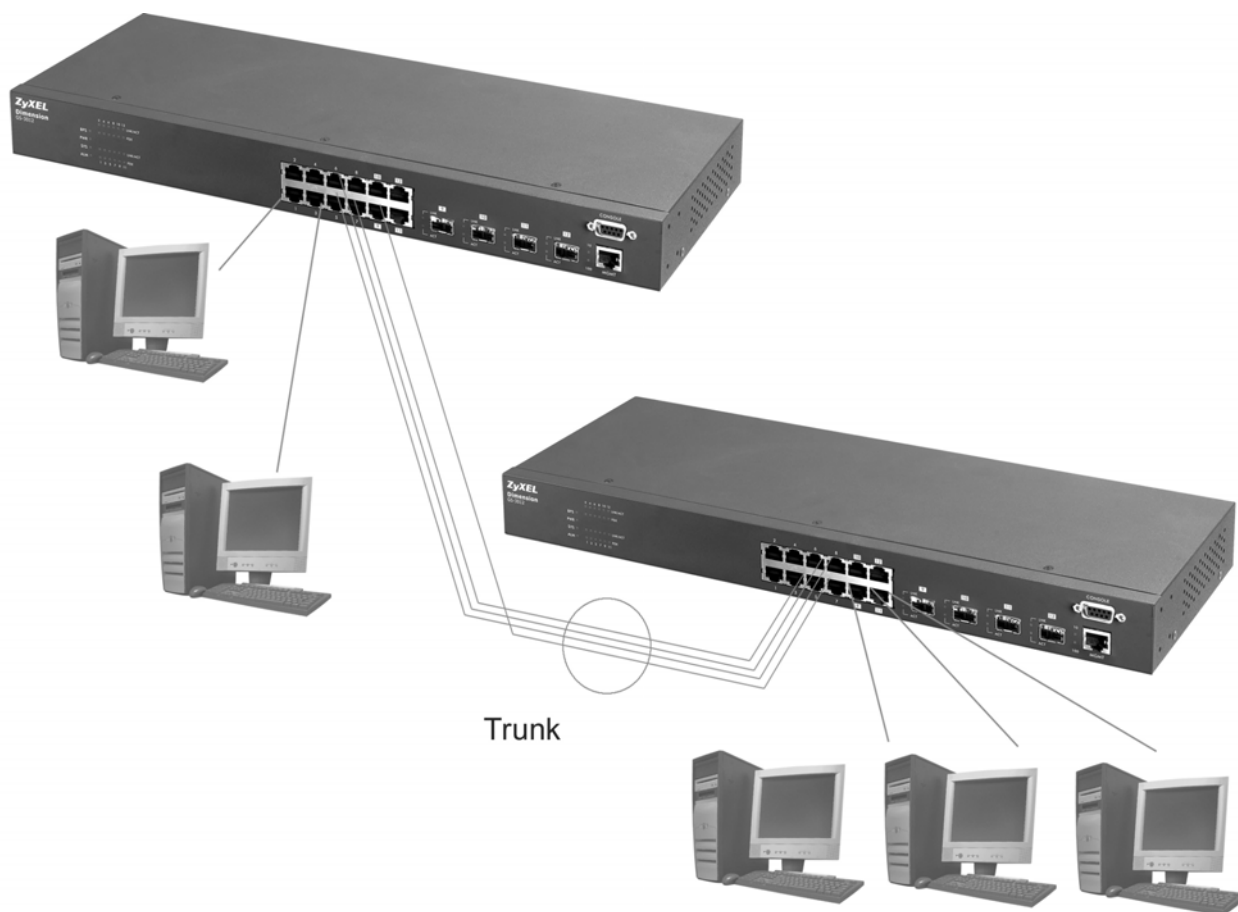

Figure 1-3 High Performance Switched Workgroup Application

1.3.4 IEEE 802.1Q VLAN Application Examples

This section shows a workgroup and a shared server example using 802.1Q tagged VLANs. For more information on VLANs, see the *Switch Setup* section and the *VLAN Setup* chapter in this User's Guide. A VLAN (Virtual Local Area Network) allows a physical network to be partitioned into multiple logical networks. Stations on a logical network belong to one group. A station can belong to more than one group. With VLAN, a station cannot directly talk to or hear from stations that are not in the same group(s) unless such traffic first goes through a router.

Tag-based VLAN Workgroup Example

Ports in the same VLAN group share the same broadcast domain thus increase network performance through reduced broadcast traffic. VLAN groups can be modified at any time by adding, moving or changing ports without any re-cabling.

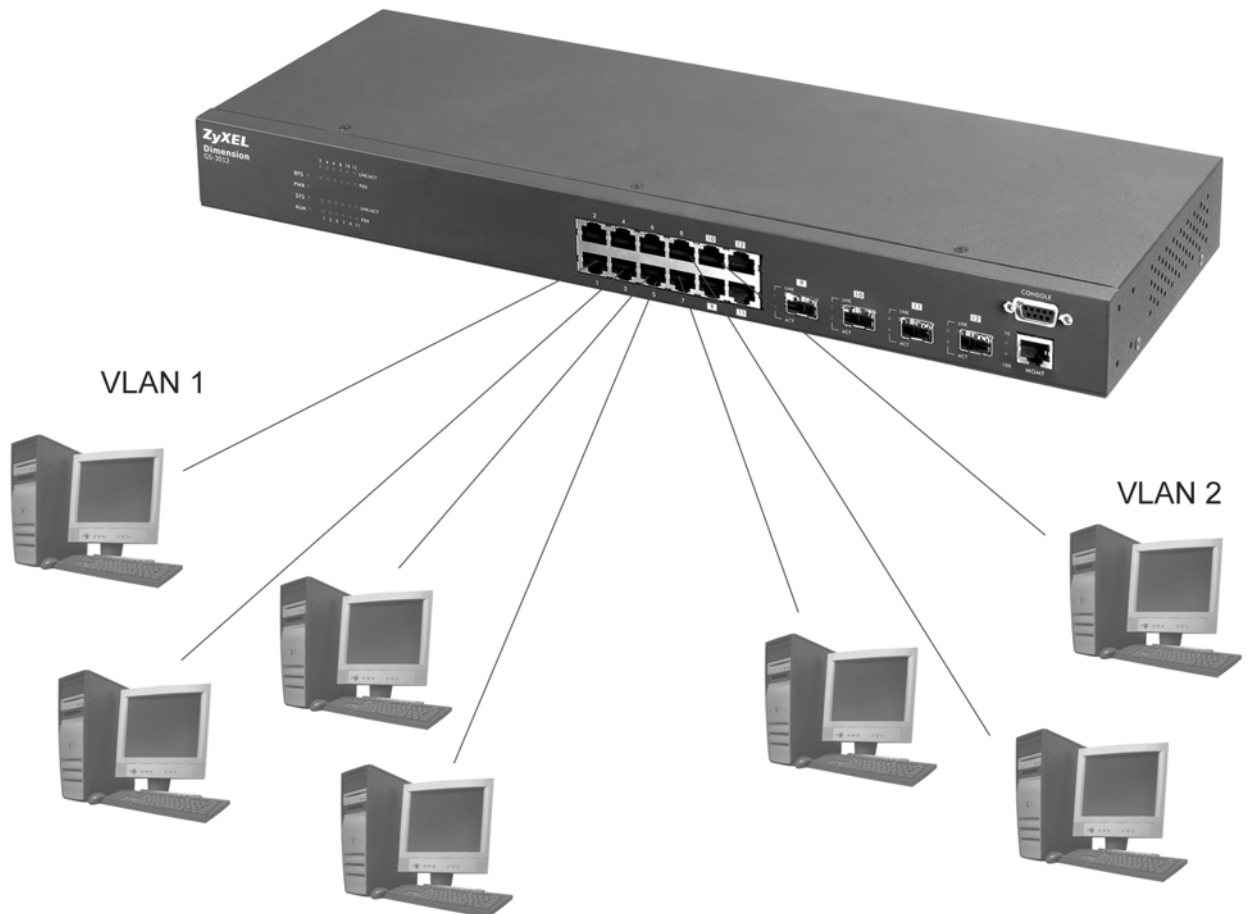

Figure 1-4 VLAN Workgroup Application

VLAN Shared Server Example

Shared resources such as a server can be used by all ports in the same VLAN as the server, as shown in the following example. In this example, only ports that need access to the server need belong to VLAN 3 while they can belong to other VLAN groups too.

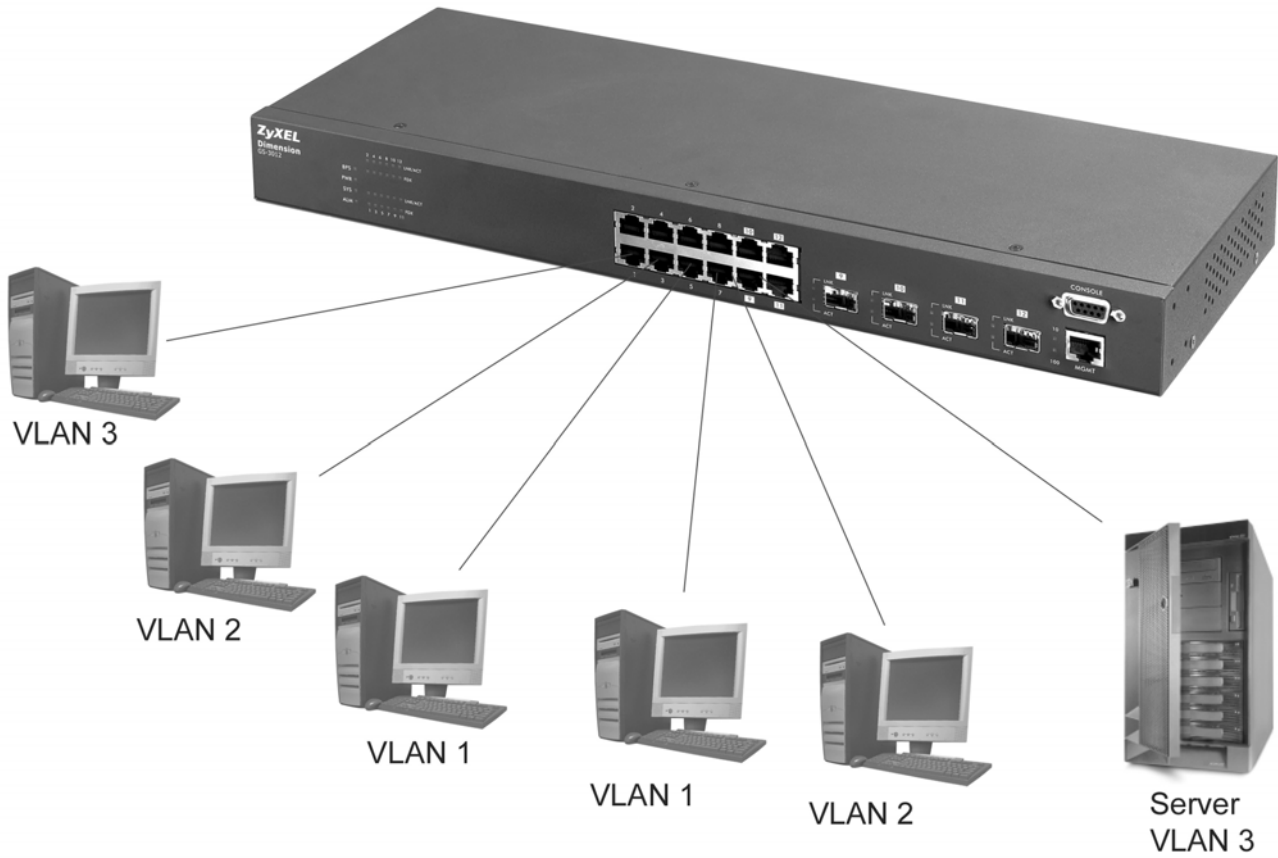

Figure 1-5 Shared Server Using VLAN Example

Part II

Hardware Installation and Connections

This part acquaints you with installation scenarios of the GS-3012, instructs you on how to make the hardware connections and explains the front panel LEDs.

Chapter 2

Hardware Installation

This chapter shows two switch installation scenarios.

2.1 Installation Scenarios

The switch can be placed on a desktop or rack-mounted on a standard EIA rack. Use the rubber feet in a desktop installation and the brackets in a rack-mounted installation.

For proper ventilation, allow at least 4 inches (10 cm) of clearance at the front and 3.4 inches (8 cm) at the back of the switch. This is especially important for enclosed rack installations.

2.1.1 Desktop Installation Procedure

- Step 1.** Make sure the switch is clean and dry.
- Step 2.** Set the switch on a smooth, level surface strong enough to support the weight of the switch and the connected cables. Make sure there is a power outlet nearby.
- Step 3.** Make sure there is enough clearance around the switch to allow air circulation and the attachment of cables and the power cord.
- Step 4.** Remove the adhesive backing from the rubber feet.
- Step 5.** Attach the rubber feet to each corner on the bottom of the switch. These rubber feet help protect the switch from shock or vibration and ensure space between switches when stacking.



Figure 2-1 Attaching Rubber Feet

Do not block the ventilation holes. Leave space between switches when stacking.

2.1.2 Rack-Mounted Installation

The switch can be mounted on an EIA standard size, 19-inch rack or in a wiring closet with other equipment. Follow the steps below to mount your switch on a standard EIA rack using a rack-mounting kit.

Dimension GS-3012 Gigabit Ethernet Switch

Step 1. Align one bracket with the holes on one side of the switch and secure it with the bracket screws smaller than the rack-mounting screws.

Step 2. Attach the other bracket in a similar fashion.



Figure 2-2 Attaching Mounting Brackets and Screws

Step 3. After attaching both mounting brackets, position the switch in the rack by lining up the holes in the brackets with the appropriate holes on the rack. Secure the switch to the rack with the rack-mounting screws.



Figure 2-3 Mounting the ES to an EIA standard 19-inch rack

Chapter 3

Hardware Connections

This chapter acquaints you with the front and rear panels, shows you how to make the connections, install/remove (optional) modules and explains the LEDs.

3.1 Safety Warnings

- The length of exposed (bare) power wire should not exceed 7mm.
- Do not use this product near water, for example, in a wet basement.
- Only a qualified technician should service or disassemble this device.

3.2 Front Panel

The following figure shows the front panel of the GS-3012. The front panel contains the switch LEDs, 12 RJ-45 gigabit ports, four mini GBIC ports and a console and management port for local management.

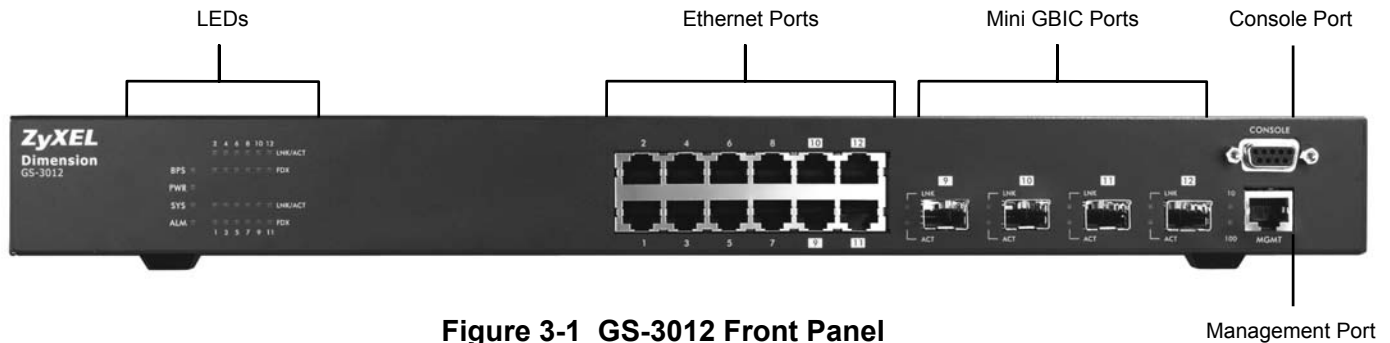

Figure 3-1 GS-3012 Front Panel

Table 3-1 GS-3012: Front Panel

CONNECTOR	DESCRIPTION
12 10/100/1000 Mbps RJ-45 Ethernet Ports	Connect these 1Gbps Electrical Ethernet ports to high-bandwidth backbone network Ethernet switches or use them to daisy-chain other switches.
Mini GBIC Ports	Use mini GBIC transceivers in these slots for fiber-optical connections to backbone Ethernet switches.
Console Port	The console port is for local configuration of the GS-3012.
Management Port	Connect to a computer using an RJ-45 Ethernet cable for local configuration of the GS-3012.

3.2.1 Console Port

For local management, you can use a computer with terminal emulation software configured to the following parameters:

- VT100 terminal emulation
- No parity, 8 data bits, 1 stop bit
- 9600 bps
- No flow control

Connect the male 9-pin end of the console cable to the console port of the GS-3012 switch. Connect the female end to a serial port (COM1, COM2 or other COM port) of your computer.

3.2.2 Gigabit Ports

The GS-3012 has 10/100/1000Mbps auto-negotiating, auto-crossover Gigabit ports. The speed of the Gigabit ports can be 10Mbps, 100Mbps or 1000Mbps and the duplex mode can be half duplex (for 10/100 Mbps) or full duplex.

When auto-negotiation is turned on, a Gigabit port on the GS-3012 negotiates with the peer automatically to determine the connection speed and duplex mode. If the peer Ethernet port does not support auto-negotiation or turns off this feature, the GS-3012 determines the connection speed by detecting the signal on the cable and using half duplex mode. When the GS-3012's auto-negotiation is turned off, a Gigabit port uses the pre-configured speed and duplex mode when making a connection, thus requiring you to make sure that the settings of the peer Ethernet port are the same in order to connect.

Four Gigabit ports are paired with the four mini GBIC slots. The switch uses up to one connection for each pair for a total of four possible Gigabit connections (one from each of the four pairs). The mini GBIC ports have priority over the Gigabit ports. This means that if a mini GBIC port and the corresponding Gigabit port are connected at the same time, the Gigabit port will be disabled.

Default Ethernet Negotiation Settings

The factory default negotiation settings for the Gigabit ports on the GS-3012 are:

- Speed: Auto
- Duplex: Auto
- Flow control: Off
- Link Aggregation: Disabled

Auto-crossover

All ports are auto-crossover, that is auto-MDIX ports (Media Dependent Interface Crossover), so you may use either a straight-through Ethernet cable or crossover Ethernet cable for all Gigabit port connections. Auto-crossover ports automatically sense whether they need to function as crossover or straight ports, so crossover cables can connect both computers and switches/hubs.

3.2.3 Mini GBIC Slots

These are slots for mini GBIC (Gigabit Interface Converter) transceiver. A transceiver is a single unit that houses a transmitter and a receiver. The GS-3012 does not come with transceivers. You must use transceivers that comply with the Small Form-factor Pluggable (SFP) Transceiver MultiSource Agreement (MSA). See the SFF committee's INF-8074i specification Rev 1.0 for details.

You can change transceivers while the switch is operating. You can use different transceivers to connect to Ethernet switches with different types of fiber-optic connectors.

To avoid possible eye injury, do not look into an operating fiber-optic module's connectors.

- Type: SFP connection interface
- Connection speed: 1 Gigabit per second (Gbps)

Transceiver Installation

Use the following steps to install a mini GBIC transceiver (SFP module).

Step 1. Insert the transceiver into the slot with the exposed section of PCB board facing down.

Step 2. Press the transceiver firmly until it clicks into place.

Step 3. The switch automatically detects the installed transceiver. Check the LEDs to verify that it is functioning properly.



Figure 3-2 Transceiver Installation Example



Figure 3-3 Installed Transceiver

Transceiver Removal

Use the following steps to remove a mini GBIC transceiver (SFP module).

Step 1. Open the transceiver's latch (latch styles vary).

Step 2. Pull the transceiver out of the slot.

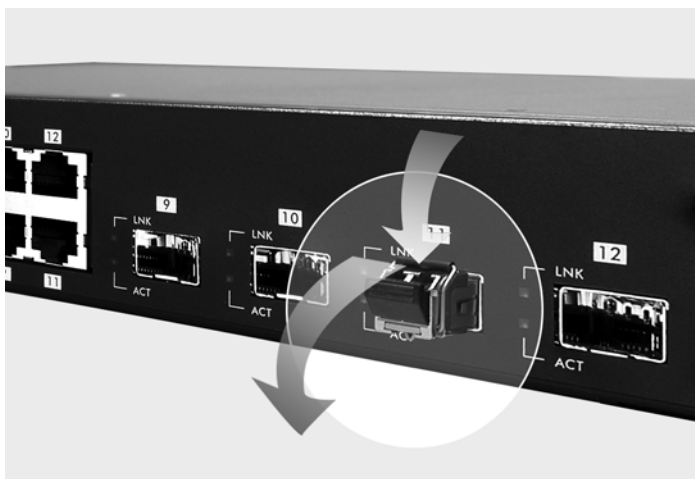

Figure 3-4 Opening the Transceiver's Latch Example



Figure 3-5 Transceiver Removal Example

3.2.4 Management Port

The **MGNT** (management) port is used for local management. The port is not used for network data transmission meaning that it is out-of-band. Connect directly to this port using an Ethernet cable. You can configure the switch via Telnet or the web configurator.

The default IP address of the management port is 192.168.0.1 with a subnet mask of 255.255.255.0.

3.3 Rear Panel

The following figure shows the rear panel of the GS-3012. The rear panel contains the ventilation holes, a connector for external backup power supply (BPS) and the power receptacle.



Figure 3-6 GS-3012 Rear Panel: AC Model



Figure 3-7 GS-3012 Rear Panel: DC Model

3.3.1 Power Connector

Make sure you are using the correct power source as shown on the panel.

To connect the power to the GS-3012 AC unit, insert the female end of power cord to the power receptacle on the rear panel. Connect the other end of the supplied power cord to a 100~240VAC/1.5A power outlet. Make sure that no objects obstruct the airflow of the fans (located on the side of the unit).

The GS-3012 DC unit requires DC power supply input of -48 VDC to -60 VDC, 1.84A Max. To connect the power to the unit, insert the one end of the supplied power cord to the power receptacle on the rear panel and the other end to a power outlet.

3.3.2 External Backup Power Supply Connector

The GS-3012 supports external backup power supply. Connect to the backup power supply.

The backup power supply constantly monitors the status of the internal power supply. The backup power supply automatically provides power into the switch in the event of a power failure. Once the GS-3012 receives power from the backup power supply, it will not automatically switch back to using the internal power supply even when the power is resumed.

3.4 Front Panel LEDs

After you connect the power to the switch, view the LEDs to ensure proper functioning of the switch and as an aid in troubleshooting.

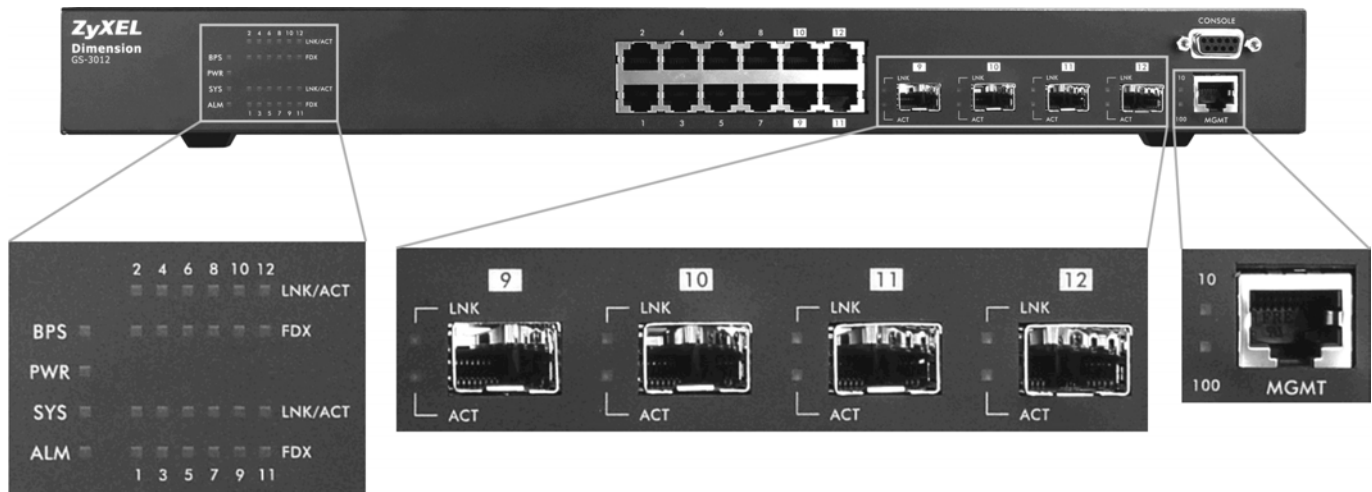

Figure 3-8 Front Panel LEDs

The following table describes the Ethernet port LEDs.

Table 3-2 Front Panel LED Descriptions

LED	COLOR	STATUS	DESCRIPTION
BPS	Green	Blinking	The system is receiving power from the backup power supply.
		On	The backup power supply is connected and active.
		Off	The backup power supply is not ready or not active.
PWR	Green	On	The system is turned on.
		Off	The system is off.
SYS	Green	Blinking	The system is rebooting and performing self-diagnostic tests.
		On	The system is on and functioning properly.
		Off	The power is off or the system is not ready/malfunctioning.
ALM	Red	On	There is a hardware failure.
		Off	The system is functioning normally.
LNK/ACT (Gigabit ports)	Green	Blinking	The system is transmitting/receiving to/from an Ethernet network.
		On	The link to a 10/1000 Mbps Ethernet network is up.
		Off	The link to an Ethernet network is down.
	Amber	Blinking	The system is transmitting/receiving to/from an Ethernet network.
		On	The link to a 100 Mbps Ethernet network is up.
		Off	The link to an Ethernet network is down.
FDX (Gigabit ports)	Amber	On	The Gigabit port is negotiating in full-duplex mode.
		Off	The Gigabit port is negotiating in half-duplex mode and no collisions are occurring.
GBIC Slots			
LNK	Green	On	The link to this port is up.

Table 3-2 Front Panel LED Descriptions

LED	COLOR	STATUS	DESCRIPTION
		Off	The link to this port is not connected.
ACT	Green	Blinking	This port is receiving or transmitting data.
MGMT			
10	Green	Blinking	The system is transmitting/receiving to/from an Ethernet device.
		On	The port is connected at 10Mbps.
		Off	The port is not connected at 10Mbps or to an Ethernet device.
100	Amber	Blinking	The system is transmitting/receiving to/from an Ethernet device.
		On	The port is connected at 100Mbps.
		Off	The port is not connected at 100Mbps or to an Ethernet device.

3.5 Configuring the GS-3012

You may use the embedded web configurator or command line interface to configure the GS-3012. If you're using the web configurator, you need Internet Explorer 5.5 and later or Netscape Navigator 6 and later.

You can access the command line interface using a terminal emulation program on a computer connected to the switch console port (see *Section 3.2.1*) or access the switch using Telnet.

You can use the “config save” command to save 802.1Q, STP, Cluster and IP configuration changes to non-volatile memory (Flash). These changes are effective after you restart the switch.

However you cannot use “config save” for all other line command configurations. These are saved in volatile memory (DRAM), so are not effective after you restart the switch.

The next part of this guide discusses configuring the GS-3012 using the web configurator.

Part III

Getting Started

This part introduces you to the GS-3012 web configurator, describes the Status and Port Details screens and shows you how to configure the Basic Setting screens.

Chapter 4

Introducing the Web Configurator

This section introduces the configuration and functions of the Web Configurator.

4.1 Introduction

The embedded web configurator allows you to manage the switch from anywhere through a standard browser such as Microsoft Internet Explorer or Netscape Navigator.

Use Internet Explorer 5.5 and later or Netscape Navigator 6 and later versions.

4.2 System Login

Step 1. Start your Internet Explorer or Netscape Navigator web browser.

Step 2. Type “http://” and the IP address of the switch (for example, the default is 192.168.1.1) in the Location or Address field. Press **Enter**.

Step 3. The login screen appears. The default username is **admin** and the associated default password is **1234**. The date and time display as shown if you have not configured a time server nor manually entered a time and date in the **General Setup** screen.



Figure 4-1 Web Configurator: login

Step 4. Click **OK** to view the first web configurator screen.

4.3 Status Screen

The **Status** screen is the first web configurator screen you see after you log in. The following figure shows the navigating components of a web configurator screen.

The screenshot shows the ZyXEL web configurator interface. At the top, there is a navigation bar with 'Status', 'Logout', and 'Help' links. On the left, a 'MENU' sidebar lists 'Basic Setting', 'Advanced Application', 'Routing Protocol', and 'Management'. The main content area displays the 'Status' page, which includes a table of port statistics and a control panel at the bottom.

Navigation Panel: Click on a tab to display related links.

Status: Click Status to view current device statistics.

Logout: Click Logout to exit the web configurator.

Help: Click here for help on configuring a screen.

Port	Link	State	LACP	TxPkts	RxPkts
1	Down	STOP	Disabled	0	0	0	0.0	0.0	0:00:00
2	Down	STOP	Disabled	0	0	0	0.0	0.0	0:00:00
3	Down	STOP	Disabled	0	0	0	0.0	0.0	0:00:00
4	Down	STOP	Disabled	0	0	0	0.0	0.0	0:00:00
5	Down	STOP	Disabled	0	0	0	0.0	0.0	0:00:00
6	Down	STOP	Disabled	0	0	0	0.0	0.0	0:00:00
7	Down	STOP	Disabled	0	0	0	0.0	0.0	0:00:00
8	Down	STOP	Disabled	0	0	0	0.0	0.0	0:00:00
9	Down	STOP	Disabled	0	0	0	0.0	0.0	0:00:00
10	Down	STOP	Disabled	0	0	0	0.0	0.0	0:00:00
11	Down	STOP	Disabled	0	0	0	0.0	0.0	0:00:00
12	Down	STOP	Disabled	0	0	0	0.0	0.0	0:00:00

System Up Time : 0:01:29

Poll Interval(s)

Port

Figure 4-2 Web Configurator Home Screen (Status)

In the navigation panel, click a main link to reveal a list of submenu links.

Table 4-1 Navigation Panel Sub-links Overview

BASIC SETTING	ADVANCED APPLICATION	ROUTING PROTOCOL	MANAGEMENT

The following table lists the various web configurator screens within the sub-links.

Table 4-2 Web Configurator Screen Sub-links Details

BASIC SETTING	ADVANCED APPLICATIONS	ROUTING PROTOCOL	MANAGEMENT
System Info	VLAN Status	Static Routing	Maintenance
General Setup	VLAN Port Setting		Firmware Upgrade
Switch Setup	Static VLAN		Restore Configuration
IP Setup	Static MAC Forwarding		Backup Configuration
Port Setup	Filtering		Load Factory Default
	Spanning Tree Protocol		Reboot System
	Status		Diagnostic
	Spanning Tree Protocol Configuration		Cluster Management
	Bandwidth Control		Status
	Broadcast Storm Control		Cluster Management Configuration
	Mirroring		MAC Table
	Link Aggregation		ARP Table
	Status		

Table 4-2 Web Configurator Screen Sub-links Details

BASIC SETTING	ADVANCED APPLICATIONS	ROUTING PROTOCOL	MANAGEMENT
	Link Aggregation Configuration Port Authentication RADIUS 802.1x Port Security Access Control SNMP Logins Service Access Control Remote Management Queuing Method Classifier Policy Rule DHCP Relay		

The following table summarizes these sub-links in the navigation panel.

Table 4-3 Navigation Panel Sub-link Descriptions

LABEL	DESCRIPTION
Basic Setting Screens	
System Info	This link takes you to a screen that displays general system and hardware monitoring information.
General Setup	This link takes you to a screen where you can configure general identification information about the switch.
Switch Setup	This link takes you to a screen where you can set up global switch parameters such as VLAN type, MAC address learning, IGMP snooping, GARP and priority queues.
IP Setup	This link takes you to a screen where you can configure the IP address, subnet mask (necessary for switch management) and DNS (domain name server).
Port Setup	This link takes you to screens where you can configure settings for individual switch ports.
Advanced Application	
VLAN	This link takes you to screens where you can configure port-based or 802.1Q VLAN (depending on what you configured in the Switch Setup menu).
Static MAC Forwarding	This link takes you to screens where you can configure static MAC addresses for a port. These static MAC addresses do not age out.
Filtering	This link takes you to a screen to set up filtering rules.
Spanning Tree Protocol	This link takes you to screens where you can configure the STP to prevent network loops.

Table 4-3 Navigation Panel Sub-link Descriptions

LABEL	DESCRIPTION
Bandwidth Control	This link takes you to screens where you can cap the maximum bandwidth allowed from specified source(s) to specified destination(s).
Broadcast Storm Control	This link takes you to a screen to set up broadcast filters.
Mirroring	This link takes you to screens where you can copy traffic from one port or ports to another port in order that you can examine the traffic from the first port without interference
Link Aggregation	This link takes you to a screen where you can logically trunk physical links to form one logical, higher-bandwidth link.
Port Authentication	This link takes you to a screen where you can configure RADIUS (Remote Authentication Dial-In User Service), a protocol for user authentication that allows you to use an external server to validate an unlimited number of users.
Port Security	This link takes you to a screen where you can activate MAC address learning and set the maximum number of MAC addresses to learn on a port.
Access Control	This link takes you to screens where you can change the system login password and configure SNMP and remote management.
Queuing Method	This link takes you to a screen where you can configure SPQ or WRR with associated queue weights for each port.
Classifier	This link takes you to a screen where you can configure classifiers.
Policy Rule	This link takes you to a screen where you can configure policy rules.
DHCP Relay	This link takes you to a screen where you can configure DHCP relay information.
Routing Protocol	
Static Routing	This link takes you to screens where you can configure static routes. A static route defines how the GS-3012 should forward traffic by configuring the TCP/IP parameters manually.
Management	
Maintenance	This link takes you to screens where you can perform firmware and configuration file maintenance as well as reboot the system.
Diagnostic	This link takes you to screens where you can view system logs and test port(s).
Cluster Management	This link takes you to a screen where you can configure clustering management and view its status.
MAC Table	This link takes you to a screen where you can view the MAC addresses (and types) of devices attached to what ports and VLAN IDs.
ARP Table	This link takes you to a screen where you can view the MAC addresses – IP address resolution table.

4.3.1 Change Your Password

After you log in for the first time, it is recommended you change the default Administrator password in the **Logins** screen. Click **Advanced Application**, **Access Control** and then **Logins** to display the next screen.

Logins [Access Control](#)

Administrator

Old Password

New Password

Retype to confirm

Please record your new password whenever you change it. The system will lock you out if you have forgotten your password.

Edit Logins

Login	User Name	Password	Retype to confirm
1	<input type="text"/>	<input type="text"/>	<input type="text"/>
2	<input type="text"/>	<input type="text"/>	<input type="text"/>
3	<input type="text"/>	<input type="text"/>	<input type="text"/>
4	<input type="text"/>	<input type="text"/>	<input type="text"/>

Apply Cancel

Figure 4-3 Web Configurator: Change Password at Login

4.4 Switch Lockout

You are locked out from managing the switch if another administrator is currently logged in. You must wait until he/she has logged out before you can log in.

Moreover, you could lock yourself (and all others) out from the switch by:

1. Deleting the management VLAN (default is VLAN 1).
2. Deleting all port-based VLANs with the CPU port as a member. The “CPU port” is the management port of the switch.
3. Filtering all traffic to the CPU port.
4. Disabling all ports.
5. Assigning minimum bandwidth to the CPU port. If you limit bandwidth to the CPU port, you may find that the switch performs sluggishly or not at all.

Be careful not to lock yourself and others out of the switch.

4.5 Resetting the Switch

If you lock yourself (and others) from the switch or forget the GS-3012 password, you will need to reload the factory-default configuration file.

Uploading the factory-default configuration file replaces the current configuration file with the factory-default configuration file. This means that you will lose all previous configurations and the speed of the console port will

be reset to the default of 9600bps with 8 data bit, no parity, one stop bit and flow control set to none. The password will also be reset to “1234” and the IP address to 192.168.1.1.

To upload the configuration file, do the following:

- Step 1.** Connect to the console port using a computer with terminal emulation software. See the chapter on hardware connections for details.
- Step 2.** Disconnect and reconnect the switch’s power to begin a session. When you reconnect the switch’s power, you will see the initial screen.
- Step 3.** When you see the message “Press any key to enter Debug Mode within 3 seconds” press any key to enter debug mode.
- Step 4.** Type `atlc` after the “Enter Debug Mode” message.
- Step 5.** Wait for the “Starting XMODEM upload” message before activating XMODEM upload on your terminal.
- Step 6.** After a successful configuration file upload, type `atgo` to restart the switch.

```

Bootbase Version: V1.0 | 04/25/2003 10:01:06
RAM: Size = 32768 Kbytes
FLASH: Intel 32M

ZyNOS Version: V3.60 (LH.0)b5 | 03/2/2004 18:00:29

Press any key to enter debug mode within 3 seconds.
.....
Enter Debug Mode
GS-3012> atlc

Starting XMODEM upload (CRC mode)....
CCCCCCCCCCCCCCCC
Total 393216 bytes received.

Erasing..
.....
OK

```

Figure 4-4 Resetting the Switch: Via Console Port

The switch is now reinitialized with a default configuration file including the default password of “1234”.

4.5.1 Logging Out of the Web Configurator

Click **Logout** in a screen to exit the web configurator. You have to log in with your password again after you log out. This is recommended after you finish a management session both for security reasons and so as you don’t lock out other switch administrators.



Figure 4-5 Web Configurator: Logout Screen

4.5.2 Help

The web configurator's online help has descriptions of individual screens and some supplementary information.

Click the **Help** link from a web configurator screen to view an online help description of that screen.

Chapter 5

System Status and Port Details

This chapter describes the system status (web configurator home page) and port details screens.

5.1 About System Statistics and Information

The home screen of the web configurator displays a port statistical summary with links to each port showing statistical details.

5.2 Port Status Summary

To view the port statistics, click **Status** in all web configurator screens to display the **Status** screen as shown next.

Status
System Up Time : 16:55:52

Port	Link	State	LACP	TxPkts	RxPkts	Errors	Tx KB/s	Rx KB/s	Up Time
1	Down	STOP	Disabled	0	0	0	0.0	0.0	0:00:00
2	Down	STOP	Disabled	0	0	0	0.0	0.0	0:00:00
3	Down	STOP	Disabled	0	0	0	0.0	0.0	0:00:00
4	Down	STOP	Disabled	0	0	0	0.0	0.0	0:00:00
5	Down	STOP	Disabled	0	0	0	0.0	0.0	0:00:00
6	Down	STOP	Disabled	0	0	0	0.0	0.0	0:00:00
7	Down	STOP	Disabled	0	0	0	0.0	0.0	0:00:00
8	Down	STOP	Disabled	0	0	0	0.0	0.0	0:00:00
9	Down	STOP	Disabled	0	0	0	0.0	0.0	0:00:00
10	Down	STOP	Disabled	0	0	0	0.0	0.0	0:00:00
11	Down	STOP	Disabled	0	0	0	0.0	0.0	0:00:00
12	Down	STOP	Disabled	0	0	0	0.0	0.0	0:00:00

Poll Interval(s)

Port

Figure 5-1 Status

The following table describes the labels in this screen.

Table 5-1 Status

LABEL	DESCRIPTION
System up Time	This field shows how long the system has been running since the last time it was started.

Table 5-1 Status

LABEL	DESCRIPTION
Port	This identifies the Gigabit port. Click a port number to display the Port Details screen (refer to <i>Section 5.2.1</i>).
Link	This field displays the speed (either 10M for 10Mbps, 100M for 100Mbps or 1000M for 1000Mbps) and the duplex (F for full duplex or H for half duplex).
State	This field displays the STP state of the port. See the <i>Spanning Tree Protocol</i> chapter for details on STP port states.
LACP	This fields displays whether the Link Aggregation Control Protocol (LACP) has been enabled on the port.
TxPkts	This field shows the number of transmitted frames on this port.
RxPkts	This field shows the number of received frames on this port.
Errors	This field shows the number of received errors on this port.
Tx KB/s	This field shows the number of kilobytes per second transmitted on this port.
Rx KB/s	This field shows the number of kilobytes per second received on this port.
Up Time	This field shows the total amount of time in hours, minutes and seconds the port has been up.
Poll Interval(s)	The text box displays how often (in seconds) this screen refreshes. You may change the refresh interval by typing a new number in the text box and then clicking Set Interval .
Stop	Click Stop to halt system statistic polling.
Clear Counter	Select a port from the Port drop-down list box and then click Clear Counter to erase the recorded statistical information for that port.

5.2.1 Port Details

Click a number in the **Port** column in the **Status** screen to display individual port statistics. Use this screen to check status and detailed performance data about an individual port on the switch.

Port Info		Port NO.	1
Link		Down	
Status		STOP	
LACP		Disabled	
TxPkts		0	
RxPkts		0	
Errors		0	
Tx KBs/s		0.0	
Rx KBs/s		0.0	
Up Time		0:00:00	
TX Packet		TX Packets	0
Multicast		0	
Broadcast		0	
Pause		0	
Tagged		0	
RX Packet		RX Packets	0
Multicast		0	
Broadcast		0	
Pause		0	
Control		0	
TX Collision		Single	0
Multiple		0	
Excessive		0	
Late		0	
Error Packet		RX CRC	0
Length		0	
Runt		0	
Distribution		64	0
65 to 127		0	
128 to 255		0	
256 to 511		0	
512 to 1023		0	
1024 to 1518		0	
Giant		0	

Figure 5-2 Status: Port Details

The following table describes the labels in this screen.

Table 5-2 Status: Port Details

LABEL	DESCRIPTION
Port Info	
Port NO.	This field identifies the Gigabit port described in this screen.
Link	This field shows whether the port connection is down, and the speed/duplex mode.
Status	This field shows the training state of the ports. The states are FORWARDING (forwarding), which means the link is functioning normally or STOP (the port is stopped to break a loop or duplicate path).
LACP	This field shows if LACP is enabled on this port or not.
TxPkts	This field shows the number of transmitted frames on this port
RxPkts	This field shows the number of received frames on this port
Errors	This field shows the number of received errors on this port.

Table 5-2 Status: Port Details

LABEL	DESCRIPTION
Tx KB/s	This field shows the number kilobytes per second transmitted on this port.
Rx KB/s	This field shows the number of kilobytes per second received on this port.
Up Time	This field shows the total amount of time the connection has been up.
Tx Packet	
The following fields display detailed information about frames transmitted.	
TX Packets	This field shows the number of good frames (unicast, multicast and broadcast) transmitted.
Multicast	This field shows the number of good multicast frames transmitted.
Broadcast	This field shows the number of good broadcast frames transmitted.
Pause	This field shows the number of 802.3x Pause frames transmitted.
Tagged	This field shows the number of frames with VLAN tags transmitted.
Rx Packet	
The following fields display detailed information about frames received.	
RX Packets	This field shows the number of good frames (unicast, multicast and broadcast) received.
Multicast	This field shows the number of good multicast frames received.
Broadcast	This field shows the number of good broadcast frames received.
Pause	This field shows the number of 802.3x Pause frames received.
Control	This field shows the number of control received (including those with CRC error) but it does not include the 802.3x Pause frames.
TX Collision	
The following fields display information on collisions while transmitting.	
Single	This is a count of successfully transmitted frames for which transmission is inhibited by exactly one collision.
Multiple	This is a count of successfully transmitted frames for which transmission was inhibited by more than one collision.
Excessive	This is a count of frames for which transmission failed due to excessive collisions. Excessive collision is defined as the number of maximum collisions before the retransmission count is reset.
Late	This is the number of times a late collision is detected, that is, after 512 bits of the frame have already been transmitted.
Error Packet	
The following fields display detailed information about frames received that were in error.	
RX CRC	This field shows the number of frames received with CRC (Cyclic Redundant Check) error(s).
Length	This field shows the number of frames received with a length that was out of range.

Table 5-2 Status: Port Details

LABEL	DESCRIPTION
Runt	This field shows the number of frames received that were too short (shorter than 64 octets), including the ones with CRC errors.
Distribution	This field shows the distribution of good packets (unicast, multicast and broadcast) received.
64	This field shows the number of packets (including bad packets) received that were 64 octets in length.
65-127	This field shows the number of packets (including bad packets) received that were between 65 and 127 octets in length.
128-255	This field shows the number of packets (including bad packets) received that were between 128 and 255 octets in length.
256-511	This field shows the number of packets (including bad packets) received that were between 256 and 511 octets in length.
512-1023	This field shows the number of packets (including bad packets) received that were between 512 and 1023 octets in length.
1024-1518	This field shows the number of packets (including bad packets) received that were between 1024 and 1518 octets in length.
Poll Interval(s)	The text box displays how often (in seconds) this screen refreshes. You may change the refresh interval by typing a new number in the text box and then clicking Set Interval .
Stop	Click Stop to stop port statistic polling.

Chapter 6

Basic Setting

*This chapter describes how to configure the **System Info**, **General Setup**, **Switch Setup**, **IP Setup** and **Port Setup** screens.*

6.1 Introducing the Basic Setting Screens

The **System Info** screen displays general switch information (such as firmware version number) and hardware polling information (such as fan speeds). The **General Setup** screen allows you to configure general switch identification information. The **General Setup** screen also allows you to set the system time manually or get the current time and date from an external server when you turn on your switch. The real time is then displayed in the switch logs. The **Switch Setup** screen allows you to set up and configure global switch features. The **IP Setup** screen allows you to configure a switch IP address, subnet mask and DNS (domain name server) for management purposes.

6.2 System Information

In the navigation panel, click **Basic Setting** and then **System Info** to display the screen as shown. You can check the firmware version number and monitor the switch temperature, fan speeds and voltage in this screen.

System Info

System Name	GS-3012
OS F/W Version	ZyNOS F/W Version: V3.60(LH.0)b0 01/14/2005
Ethernet Address	00:a0:c5:01:23:46

Hardware Monitor

Temperature Unit:

Temperature(C)	Current	MAX	MIN	Threshold	Status
MAC	32.0	32.0	24.0	65.0	Normal
CPU	31.5	31.5	23.5	65.0	Normal
PHY	29.5	29.5	24.5	65.0	Normal

FAN Speed (RPM)	Current	MAX	MIN	Threshold	Status
FAN1	5536	5580	5367	4500	Normal
FAN2	5908	5958	5716	4500	Normal
FAN3	5716	5763	5670	4500	Normal

Voltage (V)	Current	MAX	MIN	Threshold	Status
2.5	2.576	2.576	2.576	+/- 5%	Normal
1.25	1.248	1.248	1.248	+/- 10%	Normal
3.3	3.328	3.328	3.312	+/- 5%	Normal
12	11.977	12.038	11.977	+/- 10%	Normal
5	4.919	4.919	4.919	+/- 5%	Normal
1.3	1.328	1.328	1.312	+/- 5%	Normal
1.25	0.7	1.248	1.248	+/- 5%	Normal

Poll Interval(s):

Figure 6-1 System Info

The following table describes the labels in this screen.

Table 6-1 System Info

LABEL	DESCRIPTION
System Name	This field displays the switch 's model name.
ZyNOS F/W Version	This field displays the version number of the switch 's current firmware including the date created.
Ethernet Address	This field refers to the Ethernet MAC (Media Access Control) address of the switch.
Hardware Monitor	
Temperature Unit	The switch has temperature sensors that are capable of detecting and reporting if the temperature rises above the threshold. You may choose the temperature unit (Centigrade or Fahrenheit) in this field.
Temperature	MAC, CPU and PHY refer to the location of the temperature sensors on the switch printed circuit board.
Current	This field displays the current temperature measured at this sensor.

Table 6-1 System Info

LABEL	DESCRIPTION
MAX	This field displays the maximum temperature measured at this sensor.
MIN	This field displays the minimum temperature measured at this sensor.
Threshold	This field displays the upper temperature limit at this sensor.
Status	This field displays Normal for temperatures below the threshold and Error for those above.
Fan speed (RPM)	A properly functioning fan is an essential component (along with a sufficiently ventilated, cool operating environment) in order for the device to stay within the temperature threshold. Each fan has a sensor that is capable of detecting and reporting if the fan speed falls below the threshold shown.
Current	This field displays this fan's current speed in Revolutions Per Minute (RPM).
MAX	This field displays this fan's maximum speed measured in Revolutions Per Minute (RPM).
MIN	This field displays this fan's minimum speed measured in Revolutions Per Minute (RPM). "<41" is displayed for speeds too small to measure (under 2000 RPM).
Threshold	This field displays the minimum speed at which a normal fan should work.
Status	Normal indicates that this fan is functioning above the minimum speed. Error indicates that this fan is functioning below the minimum speed.
Voltage (V)	The power supply for each voltage has a sensor that is capable of detecting and reporting if the voltage falls out of the tolerance range.
Current	This is the current voltage reading.
MAX	This field displays the maximum voltage measured at this point.
MIN	This field displays the minimum voltage measured at this point.
Threshold	This field displays the minimum voltage at which the switch should work.
Status	Normal indicates that the voltage is within an acceptable operating range at this point; otherwise Error is displayed.
Poll Interval(s)	The text box displays how often (in seconds) this screen refreshes. You may change the refresh interval by typing a new number in the text box and then clicking Set Interval .
Stop	Click Stop to halt statistic polling.

6.3 General Setup

Click **Basic Setting** and **General Setup** in the navigation panel to display the screen as shown.

General Setup

System Name: GS-3012

Location:

Contact Person's Name:

Login Precedence: Local Only

Use Time Server when Bootup: None

Time Server IP Address: 0.0.0.0

Current Time: 00 : 21 : 52

New Time (hh:mm:ss): 00 : 21 : 52

Current Date: 1970 - 01 - 01

New Date (yyyy-mm-dd): 1970 - 01 - 01

Time Zone: UTC

It will take 60 seconds if time server is unreachable.

Apply Cancel

Figure 6-2 General Setup

The following table describes the labels in this screen.

Table 6-2 General Setup

LABEL	DESCRIPTION
System Name	Choose a descriptive name for identification purposes. This name consists of up to 32 printable characters; spaces are not allowed.
Location	Enter the geographic location (up to 32 characters) of your switch.
Contact Person's Name	Enter the name (up to 32 characters) of the person in charge of this switch.

Table 6-2 General Setup

LABEL	DESCRIPTION
Login Precedence	<p>Configure the local user accounts in the Access Control Logins screen. The RADIUS is an external server. Use this drop-down list box to select which database the switch should use (first) to authenticate a user.</p> <p>Before you specify the priority, make sure you have set up the corresponding database correctly first.</p> <p>Select Local Only to have the switch just check the local user accounts configured in the Access Control Logins screen.</p> <p>Select Local then RADIUS to have the switch check the local user accounts configured in the Access Control Logins screen. If the user name is not found, the switch then checks the user database on the specified RADIUS server. You need to configure the Port Authentication Radius screen first.</p> <p>Select RADIUS Only to have the switch just check the user database on the specified RADIUS server for a login username and password.</p>
Use Time Server When Bootup	<p>Enter the time service protocol that a timeserver sends when you turn on the switch. Not all timeservers support all protocols, so you may have to use trial and error to find a protocol that works. The main differences between them are the time format.</p> <p>Daytime (RFC 867) format is day/month/year/time zone of the server.</p> <p>Time (RFC-868) format displays a 4-byte integer giving the total number of seconds since 1970/1/1 at 0:0:0.</p> <p>NTP (RFC-1305) is similar to Time (RFC-868).</p> <p>None is the default value. Enter the time manually. Each time you turn on the switch, the time and date will be reset to 1970-1-1 0:0.</p>
Time Server IP Address	<p>Enter the IP address (or URL if you configure a domain name server in the IP Setup screen) of your timeserver. The switch searches for the timeserver for up to 60 seconds. If you select a timeserver that is unreachable, then this screen will appear locked for 60 seconds. Please wait.</p>
Current Time	<p>This field displays the time you open this menu (or refresh the menu).</p>
New Time (hh:min:ss)	<p>Enter the new time in hour, minute and second format. The new time then appears in the Current Time field after you click Apply.</p>
Current Date	<p>This field displays the date you open this menu.</p>
New Date (yyyy-mm-dd)	<p>Enter the new date in year, month and day format. The new date then appears in the Current Date field after you click Apply.</p>
Time Zone	<p>Select the time difference between UTC (Universal Time Coordinated, formerly known as GMT, Greenwich Mean Time) and your time zone from the drop-down list box.</p>
Apply	<p>Click Apply to save the settings.</p>
Cancel	<p>Click Cancel to start configuring the screen again.</p>

6.4 Introduction to VLANs

A VLAN (Virtual Local Area Network) allows a physical network to be partitioned into multiple logical networks. Devices on a logical network belong to one group. A device can belong to more than one group. With VLAN, a device cannot directly talk to or hear from devices that are not in the same group(s); the traffic must first go through a router.

In MTU (Multi-Tenant Unit) applications, VLAN is vital in providing isolation and security among the subscribers. When properly configured, VLAN prevents one subscriber from accessing the network resources of another on the same LAN, thus a user will not see the printers and hard disks of another user in the same building.

VLAN also increases network performance by limiting broadcasts to a smaller and more manageable logical broadcast domain. In traditional switched environments, all broadcast packets go to each and every individual port. With VLAN, all broadcasts are confined to a specific broadcast domain.

Note that VLAN is unidirectional; it only governs outgoing traffic.

See the *VLAN* chapter for information on port-based and 802.1Q tagged VLANs.

6.5 IGMP Snooping

IGMP (Internet Group Multicast Protocol) is a network-layer protocol used to establish membership in a Multicast group - it is not used to carry user data. Refer to RFC 2236 for information IGMP version 2 and RFC 1112 for IGMP version 1.

A layer-2 switch can passively snoop on IGMP Query, Report and Leave (IGMP version 2) packets transferred between IP multicast routers/switches and IP multicast hosts to learn the IP multicast group membership. It checks IGMP packets passing through it, picks out the group registration information, and configures multicasting accordingly.

Without IGMP snooping, multicast traffic is treated in the same manner as broadcast traffic, that is, it is forwarded to all ports. With IGMP snooping, group multicast traffic is only forwarded to ports that are members of that group. IGMP Snooping generates no additional network traffic, allowing you to significantly reduce multicast traffic passing through your switch.

6.6 Switch Setup Screen

Click **Basic Setting** and then **Switch Setup** in the navigation panel display the screen as shown. The VLAN setup screens change depending on whether you choose **802.1Q** or **Port Based** in the **VLAN Type** field in this screen. Refer to the chapter on VLANs.

Switch Setup

VLAN Type: 802.1Q Port Based

IGMP Snooping: Active

Bridge Control Protocol Transparency: Active

MAC Address Learning: Active Aging Time: 300 seconds

GARP Timer: Join Timer: 200 milliseconds

Leave Timer: 600 milliseconds

Leave All Timer: 10000 milliseconds

Priority Queue Assignment:

- level7: 7
- level6: 6
- level5: 5
- level4: 4
- level3: 3
- level2: 1
- level1: 0
- level0: 2

Apply Cancel

Figure 6-3 Switch Setup

The following table describes the labels in this screen.

Table 6-3 Switch Setup

LABEL	DESCRIPTION	EXAMPLE
VLAN Type	Choose 802.1Q or Port Based from the drop-down list box. The VLAN Setup screen changes depending on whether you choose 802.1Q VLAN Type or Port Based VLAN Type in this screen. See <i>Section 6.4</i> and the <i>VLAN</i> chapter for more information on VLANs.	802.1Q
IGMP Snooping	Select Active to enable IGMP snooping. See <i>Section 6.5</i> for more information on IGMP snooping.	
Bridge Control Protocol Transparency	Select Active to allow the switch to handle bridging control protocols (STP for example). You also need to define how to treat a BPDU in the Port Setup screen.	
MAC Address Learning	MAC address learning reduces outgoing traffic broadcasts. For MAC address learning to occur on a port, the port must be active.	
Aging Time	Enter a time from 10 to 3000 seconds. This is how long all dynamically learned MAC addresses remain in the MAC address table before they age out (and must be relearned).	300

Table 6-3 Switch Setup

LABEL	DESCRIPTION	EXAMPLE
<p>GARP Timer: Switches join VLANs by making a declaration. A declaration is made by issuing a Join message using GARP. Declarations are withdrawn by issuing a Leave message. A Leave All message terminates all registrations. GARP timers set declaration timeout values. See the chapter on VLAN setup for more background information.</p>		
Join Timer	<p>Join Timer sets the duration of the Join Period timer for GVRP in milliseconds. Each port has a Join Period timer. The allowed Join Time range is between 100 and 65535 milliseconds; the default is 200 milliseconds. See the chapter on VLAN setup for more background information.</p>	200 milliseconds (default)
Leave Timer	<p>Leave Timer sets the duration of the Leave Period timer for GVRP in milliseconds. Each port has a single Leave Period timer. Leave Time must be two times larger than Join Timer; the default is 600 milliseconds.</p>	600 milliseconds (default)
Leave All Timer	<p>Leave All Timer sets the duration of the Leave All Period timer for GVRP in milliseconds. Each port has a single Leave All Period timer. Leave All Timer must be larger than Leave Timer; the default is 10000 milliseconds.</p>	10000 milliseconds (default)
<p>Priority Queue Assignment</p> <p>IEEE 802.1p defines up to eight separate traffic types by inserting a tag into a MAC-layer frame that contains bits to define class of service. Frames without an explicit priority tag are given the default priority of the ingress port. Use the next two fields to configure the priority level-to-physical queue mapping.</p> <p>The switch has eight physical queues that you can map to the eight priority levels. On the switch, traffic assigned to higher index queues gets through faster while traffic in lower index queues is dropped if the network is congested.</p> <p>See also Queuing Method and 802.1p Priority in Port Setup for related information.</p>		
<p>Priority Level (The following descriptions are based on the traffic types defined in the IEEE 802.1d standard (which incorporates the 802.1p).</p>		
Level 7	Typically used for network control traffic such as router configuration messages.	
Level 6	Typically used for voice traffic that is especially sensitive to jitter (jitter is the variations in delay).	
Level 5	Typically used for video that consumes high bandwidth and is sensitive to jitter.	
Level 4	Typically used for controlled load, latency-sensitive traffic such as SNA (Systems Network Architecture) transactions.	
Level 3	Typically used for “excellent effort” or better than best effort and would include important business traffic that can tolerate some delay.	
Level 2	This is for “spare bandwidth”.	
Level 1	This is typically used for non-critical “background” traffic such as bulk transfers that are allowed but that should not affect other applications and users.	
Level 0	Typically used for best-effort traffic.	
Apply	Click Apply to save your changes back to the switch.	
Cancel	Click Cancel to begin configuring this screen afresh.	

6.7 IP Setup

Use the **IP Setup** screen to configure the switch IP address, default gateway device, the default domain name server and the management VLAN ID. The default gateway specifies the IP address of the default gateway (next hop) for outgoing traffic.

Figure 6-4 IP Setup

The following table describes the labels in this screen.

Table 6-4 IP Setup

LABEL	DESCRIPTION
Domain Name Server	DNS (Domain Name System) is for mapping a domain name to its corresponding IP address and vice versa. Enter a domain name server IP address in order to be able to use a domain name instead of an IP address.

Table 6-4 IP Setup

LABEL	DESCRIPTION
Default Management	<p>Select which traffic flow (In-Band or Out-of-band) the switch use to send packets with an unknown source or originate from the switch itself (such as SNMP traps).</p> <p>Select Out-of-band to have the switch send the packets to the out-of-band management port. This means that device(s) connected to the other port(s) do not receive these packets.</p> <p>Select In-Band to have the switch send the packets to all ports except the out-of-band management port. This means that device(s) connected to out-of-band management port do not receive these packets.</p>
In-Band Management IP Address	
DHCP Client	Select this option if you have a DHCP server that can assign the switch an IP address, subnet mask, a default gateway IP address and a domain name server IP address automatically.
Static IP Address	Select this option if you don't have a DHCP server or if you wish to assign static IP address information to the switch. You need to fill in the following fields when you select this option.
IP Address	Enter the IP address of your switch in dotted decimal notation for example 192.168.1.1.
IP Subnet Mask	Enter the IP subnet mask of your switch in dotted decimal notation for example 255.255.255.0.
Default Gateway	Enter the IP address of the default outgoing gateway in dotted decimal notation, for example 192.168.1.254.
VID	Enter the VLAN identification number associated with the switch IP address. This is the VLAN ID of the CPU and is used for management only. The default is "1". All ports, by default, are fixed members of this "management VLAN" in order to manage the device from any port. If a port is not a member of this VLAN, then users on that port cannot access the device. To access the switch make sure the port that you are connected to is a member of Management VLAN.
Out-of-band Management IP Address	
IP Address	<p>Enter the IP address of the management port in dotted decimal notation for example 192.168.0.1.</p> <p>If you change this IP address, make sure the computer connected to this management port is in the same subnet before accessing the GS.</p>
Subnet Mask	Enter the IP subnet mask in dotted decimal notation for example 255.255.255.0.
Default Gateway	Enter the IP address of the default outgoing gateway in dotted decimal notation, for example 192.168.1.254.
Apply	Click Apply to save your changes back to the switch.
Cancel	Click Cancel to begin configuring the fields again.
<p>In-band IP Addresses</p> <p>You can create up to 128 IP addresses, which are used to access and manage the switch from the ports belonging to the pre-defined VLAN(s). You must configure a VLAN first.</p>	
IP Address	Enter the IP address for managing the switch by the members of the VLAN specified in the VID field below.

Table 6-4 IP Setup

LABEL	DESCRIPTION
IP Subnet Mask	Enter the IP subnet mask in dotted decimal notation.
VID	Type the VLAN group identification number.
Default Gateway	Enter the IP address of the default outgoing gateway in dotted decimal notation.
Manageable	Select this option to allow the switch to be managed using this specified IP address.
Add	Click Add to save the new rule to the switch. It then displays in the summary table at the bottom of the screen.
Cancel	Click Cancel to reset the fields to your previous configuration.
Index	This field displays the index number of the rule. Click an index number to edit the rule.
IP Address	This field displays the IP address.
IP Subnet Mask	This field displays the subnet mask.
VID	This field displays the ID number of the VLAN group.
Default Gateway	This field displays the IP address of the default gateway.
Manageable	This field displays Yes to indicate that you can use the IP address to access and manage the switch. Otherwise, this field displays No .
Delete	Check the rule(s) that you want to remove in the Delete column, then click the Delete button.
Cancel	Click Cancel to clear the selected checkboxes in the Delete column.

6.8 Port Setup

Click **Basic Setting** and then **Port Setup** in the navigation panel to enter the port configuration screen.

Port	Active	Name	Type	Speed / Duplex	Flow Control	802.1p Priority	BPDU Control
1	<input checked="" type="checkbox"/>	Port1	10/100/1000M	Auto	<input type="checkbox"/>	0	Peer
2	<input checked="" type="checkbox"/>	Port2	10/100/1000M	Auto	<input type="checkbox"/>	0	Peer
3	<input checked="" type="checkbox"/>	Port3	10/100/1000M	Auto	<input type="checkbox"/>	0	Peer
4	<input checked="" type="checkbox"/>	Port4	10/100/1000M	Auto	<input type="checkbox"/>	0	Peer
5	<input checked="" type="checkbox"/>	Port5	10/100/1000M	Auto	<input type="checkbox"/>	0	Peer
6	<input checked="" type="checkbox"/>	Port6	10/100/1000M	Auto	<input type="checkbox"/>	0	Peer
7	<input checked="" type="checkbox"/>	Port7	10/100/1000M	Auto	<input type="checkbox"/>	0	Peer
8	<input checked="" type="checkbox"/>	Port8	10/100/1000M	Auto	<input type="checkbox"/>	0	Peer
9	<input checked="" type="checkbox"/>	Port9	10/100/1000M	Auto	<input type="checkbox"/>	0	Peer
10	<input checked="" type="checkbox"/>	Port10	10/100/1000M	Auto	<input type="checkbox"/>	0	Peer
11	<input checked="" type="checkbox"/>	Port11	10/100/1000M	Auto	<input type="checkbox"/>	0	Peer
12	<input checked="" type="checkbox"/>	Port12	10/100/1000M	Auto	<input type="checkbox"/>	0	Peer

Figure 6-5 Port Setup

The following table describes the fields in this screen.

Table 6-5 Port Setup

LABEL	DESCRIPTION
Port	This is the port index number.
Active	Select this check box to enable a port. The factory default for all ports is enabled. A port must be enabled for data transmission to occur.
Name	Enter a descriptive name that identifies this port.
Type	This field displays 10/100/1000M for this connection.
Speed/Duplex	<p>Select the speed and the duplex mode of the connection on this port. Choices are Auto, 10M/Half Duplex, 10M/Full Duplex, 100M/Half Duplex, 100M/Full Duplex, 1000M/Half Duplex and 1000M/Full Duplex.</p> <p>Selecting Auto (auto-negotiation) makes one Gigabit port able to negotiate with a peer automatically to obtain the connection speed and duplex mode that both ends support. When auto-negotiation is turned on, a Gigabit port on the switch negotiates with the peer automatically to determine the connection speed and duplex mode. If the peer Ethernet port does not support auto-negotiation or turns off this feature, the switch determines the connection speed by detecting the signal on the cable and using half duplex mode. When the switch's auto-negotiation is turned off, a Gigabit port uses the pre-configured speed and duplex mode when making a connection, thus requiring you to make sure that the settings of the peer Ethernet port are the same in order to connect.</p>

Table 6-5 Port Setup

LABEL	DESCRIPTION
Flow Control	<p>A concentration of traffic on a port decreases port bandwidth and overflows buffer memory causing packet discards and frame losses. Flow Control is used to regulate transmission of signals to match the bandwidth of the receiving port.</p> <p>The switch uses IEEE802.3x flow control in full duplex mode and backpressure flow control in half duplex mode.</p> <p>IEEE802.3x flow control is used in full duplex mode to send a pause signal to the sending port, causing it to temporarily stop sending signals when the receiving port memory buffers fill.</p> <p>Back Pressure flow control is typically used in half duplex mode to send a "collision" signal to the sending port (mimicking a state of packet collision) causing the sending port to temporarily stop sending signals and resend later. Select this option to enable flow control.</p>
802.1P Priority	<p>This priority value is added to incoming frames without a (802.1p) priority queue tag. See Priority Queue Assignment in <i>Table 6-3</i> for more information. See also Priority Queue Assignment in Switch Setup and Queuing Method for related information.</p>
BPDU	<p>Configure the way to treat BPDUs received on this port.</p> <hr/> <p>You must activate bridging control protocol transparency in the Switch Setup screen first.</p> <hr/> <p>Select Peer to process any BPDU (Bridge Protocol Data Units) received on this port.</p> <p>Select Tunnel to forward BPDUs received on this port.</p> <p>Select Discard to drop any BPDU received on this port.</p> <p>Select Network to process a BPDU with no VLAN tag and forward a tagged BPDU.</p>
Apply	<p>Click Apply to save your changes back to the switch.</p>
Cancel	<p>Click Cancel to begin configuring this screen afresh.</p>

Part IV

Advanced Application 1

This part shows you how to configure the VLAN, Static MAC Forwarding, Filtering, STP and Bandwidth Control Advanced Application screens.

Chapter 7

VLAN

*The type of screen you see here depends on the **VLAN Type** you selected in the **Switch Setup** screen. This chapter shows you how to configure 802.1Q tagged and port-based VLANs. See the *General, Switch and IP Setup* chapter for more information.*

7.1 Introduction to IEEE 802.1Q Tagged VLAN

Tagged VLAN uses an explicit tag (VLAN ID) in the MAC header to identify the VLAN membership of a frame across bridges - they are not confined to the switch on which they were created. The VLANs can be created statically by hand or dynamically through GVRP. The VLAN ID associates a frame with a specific VLAN and provides the information that switches need to process the frame across the network. A tagged frame is four bytes longer than an untagged frame and contains two bytes of TPID (Tag Protocol Identifier, residing within the type/length field of the Ethernet frame) and two bytes of TCI (Tag Control Information, starts after the source address field of the Ethernet frame).

The CFI (Canonical Format Indicator) is a single-bit flag, always set to zero for Ethernet switches. If a frame received at an Ethernet port has a CFI set to 1, then that frame should not be forwarded as it is to an untagged port. The remaining twelve bits define the VLAN ID, giving a possible maximum number of 4,096 (2¹²) VLANs. Note that user priority and VLAN ID are independent of each other. A frame with VID (VLAN Identifier) of null (0) is called a priority frame, meaning that only the priority level is significant and the default VID of the ingress port is given as the VID of the frame. Of the 4096 possible VIDs, a VID of 0 is used to identify priority frames and value 4095 (FFF) is reserved, so the maximum possible VLAN configurations are 4,094

TPID 2 Bytes	User Priority 3 Bits	CFI 1 Bit	VLAN ID 12 bits
-----------------	-------------------------	--------------	--------------------

7.1.1 Forwarding Tagged and Untagged Frames

Each port on the switch is capable of passing tagged or untagged frames. To forward a frame from an 802.1Q VLAN-aware switch to an 802.1Q VLAN-unaware switch, the switch first decides where to forward the frame and then strips off the VLAN tag. To forward a frame from an 802.1Q VLAN-unaware switch to an 802.1Q VLAN-aware switch, the switch first decides where to forward the frame, and then inserts a VLAN tag reflecting the ingress port's default VID. The default PVID is VLAN 1 for all ports, but this can be changed.

7.1.2 Automatic VLAN Registration

GARP and GVRP are the protocols used to automatically register VLAN membership across switches.

GARP

GARP (Generic Attribute Registration Protocol) allows network switches to register and de-register attribute values with other GARP participants within a bridged LAN. GARP is a protocol that provides a generic mechanism for protocols that serve a more specific application, for example, GVRP.

GARP Timers

Switches join VLANs by making a declaration. A declaration is made by issuing a Join message using GARP. Declarations are withdrawn by issuing a Leave message. A Leave All message terminates all registrations. GARP timers set declaration timeout values.

GVRP

GVRP (GARP VLAN Registration Protocol) is a registration protocol that defines a way for switches to register necessary VLAN members on ports across the network. Enable this function to permit VLANs groups beyond the local switch.

Please refer to the following table for common GARP terminology.

Table 7-1 GARP Terminology

VLAN PARAMETER	TERM	DESCRIPTION
VLAN Type	Permanent VLAN	This is a static VLAN created manually.
	Dynamic VLAN	This is a VLAN configured by a GVRP registration/deregistration process.
VLAN Administrative Control	Registration Fixed	Fixed registration ports are permanent VLAN members.
	Registration Forbidden	Ports with registration forbidden are forbidden to join the specified VLAN.
	Normal Registration	Ports dynamically join a VLAN using GVRP.
VLAN Tag Control	Tagged	Ports belonging to the specified VLAN tag all outgoing frames transmitted.
	Untagged	Ports belonging to the specified don't tag all outgoing frames transmitted.
VLAN Port	Port VID	This is the VLAN ID assigned to untagged frames that this port received.
	Acceptable frame type	You may choose to accept both tagged and untagged incoming frames or just tagged incoming frames on a port.
	Ingress filtering	If set, the switch discards incoming frames for VLANs that do not have this port as a member

7.1.3 Port VLAN Trunking

Enable **VLAN Trunking** on a port to allow frames belonging to unknown VLAN groups to pass through that port. This is useful if you want to set up VLAN groups on end devices without having to configure the same VLAN groups on intermediary devices.

Refer to the following figure. Suppose you want to create VLAN groups 1 and 2 (V1 and V2) on devices A and B. Without **VLAN Trunking**, you must configure VLAN groups 1 and 2 on all intermediary switches C, D and E; otherwise they will drop frames with unknown VLAN group tags. However, with **VLAN Trunking** enabled on a port(s) in each intermediary switch you only need to create VLAN groups in the end devices (A and B). C, D and E automatically allow frames with VLAN group tags 1 and 2 (VLAN groups that are unknown to those switches) to pass through their VLAN trunking port(s).

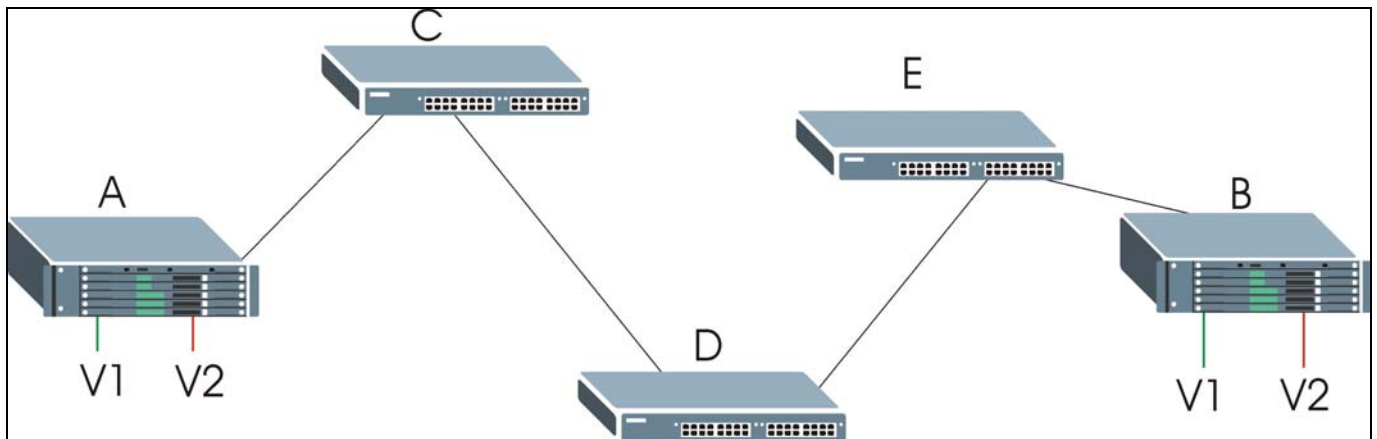

Figure 7-1 Port VLAN Trunking

7.2 802.1Q VLAN

Follow the steps below to set the **802.1Q VLAN Type** on the switch.

Step 1. Select **802.1Q** as the **VLAN Type** in the **Switch Setup** screen (under **Basic Setting**) and click **Apply**.



Figure 7-2 Selecting a VLAN Type

Step 2. Click **VLAN** under **Advanced Application** to display the **VLAN Status** screen as shown next.

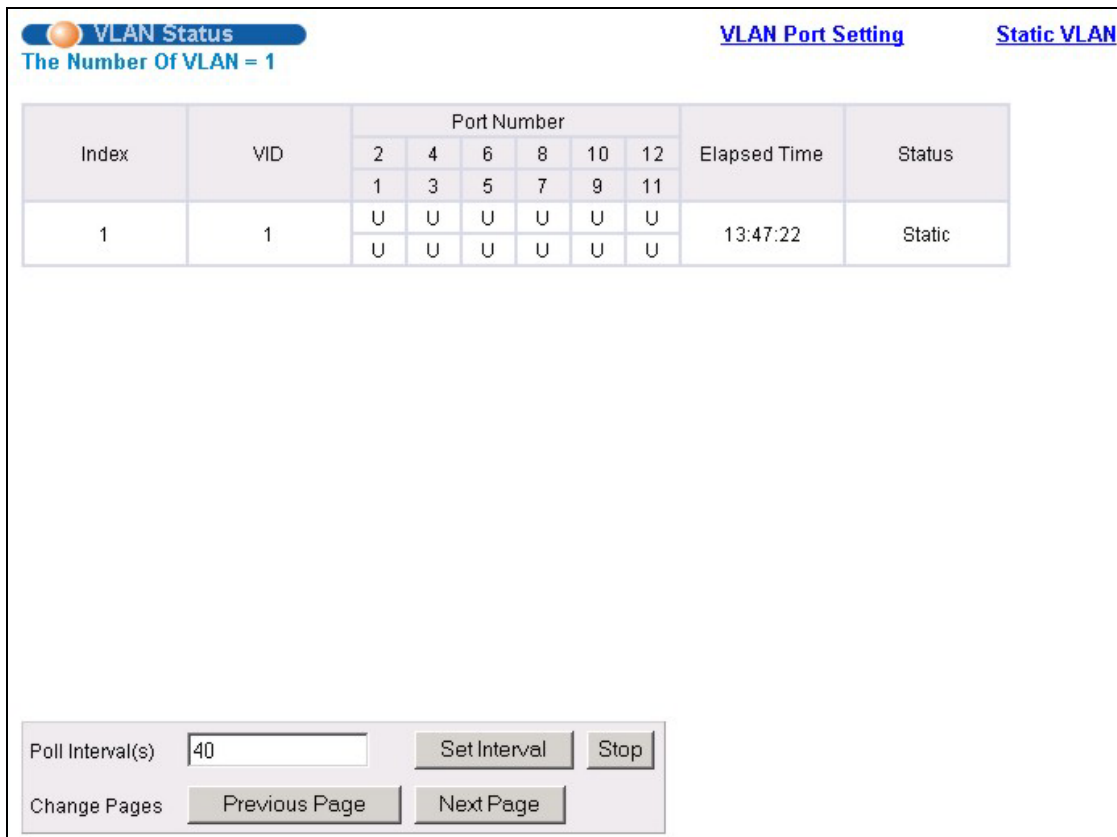

Figure 7-3 802.1Q VLAN Status

The following table describes the labels in this screen.

Table 7-2 802.1Q VLAN Status

LABEL	DESCRIPTION
The Number of VLAN	This is the number of VLANs configured on the switch.
Index	This is the VLAN index number.
VID	VID is the PVID, the Port VLAN ID assigned to untagged frames or priority-tagged frames received on this port that you configure in the VLAN Port Setting screen.
Port Number	This column displays the ports that are participating in a VLAN. A tagged port is marked as T , an untagged port is marked as U and ports not participating in a VLAN in marked as – .
Elapsed Time	This field shows how long it has been since a normal VLAN was registered or a static VLAN was set up.
Status	This field shows how this VLAN was added to the switch; dynamically using GVRP or statically, that is, added as a permanent entry.
Poll Interval(s)	The text box displays how often (in seconds) this screen refreshes. You may change the refresh interval by typing a new number in the text box and then clicking Set Interval .
Stop	Click Stop to halt polling statistics.

Table 7-2 802.1Q VLAN Status

LABEL	DESCRIPTION
Previous/Next Page	Click one of these buttons to show the previous/next screen if all status information cannot be seen in one screen.

7.2.1 802.1Q VLAN Port Settings

To configure the 802.1Q VLAN settings on a port, click the **VLAN Port Settings** link in the **VLAN Status** screen.

Port	Ingress Check	PVID	GVRP	Acceptable Frame Type	VLAN Trunking
1	<input type="checkbox"/>	1	<input type="checkbox"/>	All	<input type="checkbox"/>
2	<input type="checkbox"/>	1	<input type="checkbox"/>	All	<input type="checkbox"/>
3	<input type="checkbox"/>	1	<input type="checkbox"/>	All	<input type="checkbox"/>
4	<input type="checkbox"/>	1	<input type="checkbox"/>	All	<input type="checkbox"/>
5	<input type="checkbox"/>	1	<input type="checkbox"/>	All	<input type="checkbox"/>
6	<input type="checkbox"/>	1	<input type="checkbox"/>	All	<input type="checkbox"/>
7	<input type="checkbox"/>	1	<input type="checkbox"/>	All	<input type="checkbox"/>
8	<input type="checkbox"/>	1	<input type="checkbox"/>	All	<input type="checkbox"/>
9	<input type="checkbox"/>	1	<input type="checkbox"/>	All	<input type="checkbox"/>
10	<input type="checkbox"/>	1	<input type="checkbox"/>	All	<input type="checkbox"/>
11	<input type="checkbox"/>	1	<input type="checkbox"/>	All	<input type="checkbox"/>
12	<input type="checkbox"/>	1	<input type="checkbox"/>	All	<input type="checkbox"/>

Figure 7-4 802.1Q VLAN Port Settings

The following table describes the labels in this screen.

Table 7-3 802.1Q VLAN Port Settings

LABEL	DESCRIPTION
GVRP	GVRP (GARP VLAN Registration Protocol) is a registration protocol that defines a way for switches to dynamically register necessary VLAN members on ports across the network. Select this check box to permit VLAN groups beyond the local switch.
Port Isolation	Port Isolation allows each port (1 to 12) to communicate with the CPU port and the shared GBIC ports (9 to 12) but not communicate with each other. This option is the most limiting but also the most secure.
Port	This field displays the port numbers.

Table 7-3 802.1Q VLAN Port Settings

LABEL	DESCRIPTION
Ingress Check	If this check box is selected for a port, the device discards incoming frames for VLANs that do not include this port in its member set.
PVID	Each port on the switch is capable of passing tagged or untagged frames. To forward a frame from an 802.1Q VLAN-unaware switch to an 802.1Q VLAN-aware switch, the switch first decides where to forward the frame, and then inserts a VLAN tag reflecting the default ingress port's VLAN ID, the PVID. The default PVID is VLAN 1 for all ports, but this can be changed to any number between 0 and 4094.
GVRP	Select this check box to permit VLANs groups beyond the local switch on this port. GVRP (GARP VLAN Registration Protocol) is a registration protocol that defines a way for switches to register necessary VLAN members on ports across the network.
Acceptable Frame Type	Specify the type of frames allowed on a port. Choices are All and Tag Only . Select All to accept all frames with untagged or tagged frames on this port. This is the default setting. Select Tag Only to accept only tagged frames on this port. All untagged frames are dropped.
VLAN Trunking	Enable VLAN Trunking on ports connected to other switches or routers (but not ports directly connected to end users) to allow frames belonging to unknown VLAN groups to pass through the switch.
Apply	Click Apply to save the changes.
Cancel	Click Cancel to start configuring the screen again.

7.2.2 802.1Q Static VLAN

You can dynamically have a port join a VLAN group using GVRP, permanently assign a port to be a member of a VLAN group or prohibit a port from joining a VLAN group in this screen. Click **Static VLAN** in the **VLAN Status** screen to display the screen as shown next.

Static VLAN VLAN Status

ACTIVE

Name

VLAN Group ID

Port	Control			Tagging
1	<input checked="" type="radio"/> Normal	<input type="radio"/> Fixed	<input type="radio"/> Forbidden	<input checked="" type="checkbox"/> Tx Tagging
2	<input checked="" type="radio"/> Normal	<input type="radio"/> Fixed	<input type="radio"/> Forbidden	<input checked="" type="checkbox"/> Tx Tagging
3	<input checked="" type="radio"/> Normal	<input type="radio"/> Fixed	<input type="radio"/> Forbidden	<input checked="" type="checkbox"/> Tx Tagging
4	<input checked="" type="radio"/> Normal	<input type="radio"/> Fixed	<input type="radio"/> Forbidden	<input checked="" type="checkbox"/> Tx Tagging
5	<input checked="" type="radio"/> Normal	<input type="radio"/> Fixed	<input type="radio"/> Forbidden	<input checked="" type="checkbox"/> Tx Tagging
6	<input checked="" type="radio"/> Normal	<input type="radio"/> Fixed	<input type="radio"/> Forbidden	<input checked="" type="checkbox"/> Tx Tagging
7	<input checked="" type="radio"/> Normal	<input type="radio"/> Fixed	<input type="radio"/> Forbidden	<input checked="" type="checkbox"/> Tx Tagging
8	<input checked="" type="radio"/> Normal	<input type="radio"/> Fixed	<input type="radio"/> Forbidden	<input checked="" type="checkbox"/> Tx Tagging
9	<input checked="" type="radio"/> Normal	<input type="radio"/> Fixed	<input type="radio"/> Forbidden	<input checked="" type="checkbox"/> Tx Tagging
10	<input checked="" type="radio"/> Normal	<input type="radio"/> Fixed	<input type="radio"/> Forbidden	<input checked="" type="checkbox"/> Tx Tagging
11	<input checked="" type="radio"/> Normal	<input type="radio"/> Fixed	<input type="radio"/> Forbidden	<input checked="" type="checkbox"/> Tx Tagging
12	<input checked="" type="radio"/> Normal	<input type="radio"/> Fixed	<input type="radio"/> Forbidden	<input checked="" type="checkbox"/> Tx Tagging

Add Cancel Clear

VID	Active	Name	Delete
1	Yes	1	<input type="checkbox"/>

Delete Cancel

Figure 7-5 802.1Q Static VLAN

The following table describes the labels in this screen.

Table 7-4 802.1Q Static VLAN

LABEL	DESCRIPTION
Active	Select this check box to enable the VLAN.
Name	Enter a descriptive name for this VLAN group for identification purposes.
VLAN Group ID	Enter the VLAN ID for this static VLAN entry; the valid range is between 1 and 4094.
Port	The port number identifies the port you are configuring.
Control	Select Normal for the port to dynamically join this VLAN group using GVRP. This is the default selection. Select Fixed for the port to be a permanent member of this VLAN group. Select Forbidden if you want to prohibit the port from joining this VLAN group.
Tagging	Select TX Tagging if you want the port to tag all outgoing frames transmitted with this VLAN Group ID.
Add	Click Add to save the new rule to the switch. It then displays in the summary table at the bottom of the screen.

Table 7-4 802.1Q Static VLAN

LABEL	DESCRIPTION
Cancel	Click Cancel to reset the fields to your previous configuration.
Clear	Click Clear to clear the fields to the factory defaults.

7.2.3 Viewing and Editing VLAN Settings

To view a summary of the VLAN configuration, scroll down to the summary table at the bottom of the **Static VLAN** screen.

To change the settings of a rule, click a number in the **VID** field.

VID	Active	Name	Delete
1	Yes	1	<input type="checkbox"/>

Delete Cancel

Figure 7-6 Static VLAN: Summary Table

The following table describes the labels in this screen.

Table 7-5 Static VLAN: Summary Table

LABEL	DESCRIPTION
VID	This field displays the ID number of the VLAN group. Click the number to edit the VLAN settings.
Active	This field indicates whether the VLAN settings are enabled (Yes) or disabled (No).
Name	This field displays the descriptive name for this VLAN group.
Delete	Check the rule(s) that you want to remove in the Delete column, then click the Delete button.
Cancel	Click Cancel to clear the Delete check boxes.

VID1 Example Screen

Port	Control	Tagging
1	<input type="radio"/> Normal <input checked="" type="radio"/> Fixed <input type="radio"/> Forbidden	<input type="checkbox"/> Tx Tagging
2	<input type="radio"/> Normal <input checked="" type="radio"/> Fixed <input type="radio"/> Forbidden	<input type="checkbox"/> Tx Tagging
3	<input type="radio"/> Normal <input checked="" type="radio"/> Fixed <input type="radio"/> Forbidden	<input type="checkbox"/> Tx Tagging
4	<input type="radio"/> Normal <input checked="" type="radio"/> Fixed <input type="radio"/> Forbidden	<input type="checkbox"/> Tx Tagging
5	<input type="radio"/> Normal <input checked="" type="radio"/> Fixed <input type="radio"/> Forbidden	<input type="checkbox"/> Tx Tagging
6	<input type="radio"/> Normal <input checked="" type="radio"/> Fixed <input type="radio"/> Forbidden	<input type="checkbox"/> Tx Tagging
7	<input type="radio"/> Normal <input checked="" type="radio"/> Fixed <input type="radio"/> Forbidden	<input type="checkbox"/> Tx Tagging
8	<input type="radio"/> Normal <input checked="" type="radio"/> Fixed <input type="radio"/> Forbidden	<input type="checkbox"/> Tx Tagging
9	<input type="radio"/> Normal <input checked="" type="radio"/> Fixed <input type="radio"/> Forbidden	<input type="checkbox"/> Tx Tagging
10	<input type="radio"/> Normal <input checked="" type="radio"/> Fixed <input type="radio"/> Forbidden	<input type="checkbox"/> Tx Tagging
11	<input type="radio"/> Normal <input checked="" type="radio"/> Fixed <input type="radio"/> Forbidden	<input type="checkbox"/> Tx Tagging
12	<input type="radio"/> Normal <input checked="" type="radio"/> Fixed <input type="radio"/> Forbidden	<input type="checkbox"/> Tx Tagging

Figure 7-7 VID1 Example Screen

7.3 Introduction to Port-based VLANs

Port-based VLANs are VLANs where the packet forwarding decision is based on the destination MAC address and its associated port.

Port-based VLANs require allowed outgoing ports to be defined for each port. Therefore, if you wish to allow two subscriber ports to talk to each other, for example, between conference rooms in a hotel, you must define the egress (an egress port is an outgoing port, that is, a port through which a data packet leaves) for both ports.

Port-based VLANs are specific only to the switch on which they were created.

The port-based VLAN setup screen is shown next. The CPU management port forms a VLAN with all Gigabit ports.

7.3.1 Configuring a Port-based VLAN

Select **Port Based** as the **VLAN Type** in the **Switch Setup** screen under **Basic Setting** and then click **VLAN** under **Advanced Application** to display the next screen.

Port Based VLAN Setup

Setting Wizard: All connected Apply

Incoming

	1	2	3	4	5	6	7	8	9	10	11	12	
1	<input checked="" type="checkbox"/>	<input checked="" type="checkbox"/>	<input checked="" type="checkbox"/>	<input checked="" type="checkbox"/>	<input checked="" type="checkbox"/>	<input checked="" type="checkbox"/>	<input checked="" type="checkbox"/>	<input checked="" type="checkbox"/>	<input checked="" type="checkbox"/>	<input checked="" type="checkbox"/>	<input checked="" type="checkbox"/>	<input checked="" type="checkbox"/>	1
2	<input checked="" type="checkbox"/>	<input checked="" type="checkbox"/>	<input checked="" type="checkbox"/>	<input checked="" type="checkbox"/>	<input checked="" type="checkbox"/>	<input checked="" type="checkbox"/>	<input checked="" type="checkbox"/>	<input checked="" type="checkbox"/>	<input checked="" type="checkbox"/>	<input checked="" type="checkbox"/>	<input checked="" type="checkbox"/>	<input checked="" type="checkbox"/>	2
3	<input checked="" type="checkbox"/>	<input checked="" type="checkbox"/>	<input checked="" type="checkbox"/>	<input checked="" type="checkbox"/>	<input checked="" type="checkbox"/>	<input checked="" type="checkbox"/>	<input checked="" type="checkbox"/>	<input checked="" type="checkbox"/>	<input checked="" type="checkbox"/>	<input checked="" type="checkbox"/>	<input checked="" type="checkbox"/>	<input checked="" type="checkbox"/>	3
4	<input checked="" type="checkbox"/>	<input checked="" type="checkbox"/>	<input checked="" type="checkbox"/>	<input checked="" type="checkbox"/>	<input checked="" type="checkbox"/>	<input checked="" type="checkbox"/>	<input checked="" type="checkbox"/>	<input checked="" type="checkbox"/>	<input checked="" type="checkbox"/>	<input checked="" type="checkbox"/>	<input checked="" type="checkbox"/>	<input checked="" type="checkbox"/>	4
5	<input checked="" type="checkbox"/>	<input checked="" type="checkbox"/>	<input checked="" type="checkbox"/>	<input checked="" type="checkbox"/>	<input checked="" type="checkbox"/>	<input checked="" type="checkbox"/>	<input checked="" type="checkbox"/>	<input checked="" type="checkbox"/>	<input checked="" type="checkbox"/>	<input checked="" type="checkbox"/>	<input checked="" type="checkbox"/>	<input checked="" type="checkbox"/>	5
6	<input checked="" type="checkbox"/>	<input checked="" type="checkbox"/>	<input checked="" type="checkbox"/>	<input checked="" type="checkbox"/>	<input checked="" type="checkbox"/>	<input checked="" type="checkbox"/>	<input checked="" type="checkbox"/>	<input checked="" type="checkbox"/>	<input checked="" type="checkbox"/>	<input checked="" type="checkbox"/>	<input checked="" type="checkbox"/>	<input checked="" type="checkbox"/>	6
Outgoing 7	<input checked="" type="checkbox"/>	<input checked="" type="checkbox"/>	<input checked="" type="checkbox"/>	<input checked="" type="checkbox"/>	<input checked="" type="checkbox"/>	<input checked="" type="checkbox"/>	<input checked="" type="checkbox"/>	<input checked="" type="checkbox"/>	<input checked="" type="checkbox"/>	<input checked="" type="checkbox"/>	<input checked="" type="checkbox"/>	<input checked="" type="checkbox"/>	7
8	<input checked="" type="checkbox"/>	<input checked="" type="checkbox"/>	<input checked="" type="checkbox"/>	<input checked="" type="checkbox"/>	<input checked="" type="checkbox"/>	<input checked="" type="checkbox"/>	<input checked="" type="checkbox"/>	<input checked="" type="checkbox"/>	<input checked="" type="checkbox"/>	<input checked="" type="checkbox"/>	<input checked="" type="checkbox"/>	<input checked="" type="checkbox"/>	8
9	<input checked="" type="checkbox"/>	<input checked="" type="checkbox"/>	<input checked="" type="checkbox"/>	<input checked="" type="checkbox"/>	<input checked="" type="checkbox"/>	<input checked="" type="checkbox"/>	<input checked="" type="checkbox"/>	<input checked="" type="checkbox"/>	<input checked="" type="checkbox"/>	<input checked="" type="checkbox"/>	<input checked="" type="checkbox"/>	<input checked="" type="checkbox"/>	9
10	<input checked="" type="checkbox"/>	<input checked="" type="checkbox"/>	<input checked="" type="checkbox"/>	<input checked="" type="checkbox"/>	<input checked="" type="checkbox"/>	<input checked="" type="checkbox"/>	<input checked="" type="checkbox"/>	<input checked="" type="checkbox"/>	<input checked="" type="checkbox"/>	<input checked="" type="checkbox"/>	<input checked="" type="checkbox"/>	<input checked="" type="checkbox"/>	10
11	<input checked="" type="checkbox"/>	<input checked="" type="checkbox"/>	<input checked="" type="checkbox"/>	<input checked="" type="checkbox"/>	<input checked="" type="checkbox"/>	<input checked="" type="checkbox"/>	<input checked="" type="checkbox"/>	<input checked="" type="checkbox"/>	<input checked="" type="checkbox"/>	<input checked="" type="checkbox"/>	<input checked="" type="checkbox"/>	<input checked="" type="checkbox"/>	11
12	<input checked="" type="checkbox"/>	<input checked="" type="checkbox"/>	<input checked="" type="checkbox"/>	<input checked="" type="checkbox"/>	<input checked="" type="checkbox"/>	<input checked="" type="checkbox"/>	<input checked="" type="checkbox"/>	<input checked="" type="checkbox"/>	<input checked="" type="checkbox"/>	<input checked="" type="checkbox"/>	<input checked="" type="checkbox"/>	<input checked="" type="checkbox"/>	12
CPU	<input checked="" type="checkbox"/>	<input checked="" type="checkbox"/>	<input checked="" type="checkbox"/>	<input checked="" type="checkbox"/>	<input checked="" type="checkbox"/>	<input checked="" type="checkbox"/>	<input checked="" type="checkbox"/>	<input checked="" type="checkbox"/>	<input checked="" type="checkbox"/>	<input checked="" type="checkbox"/>	<input checked="" type="checkbox"/>	<input checked="" type="checkbox"/>	CPU

Apply Cancel

Figure 7-8 Port Based VLAN Setup (All Connected)

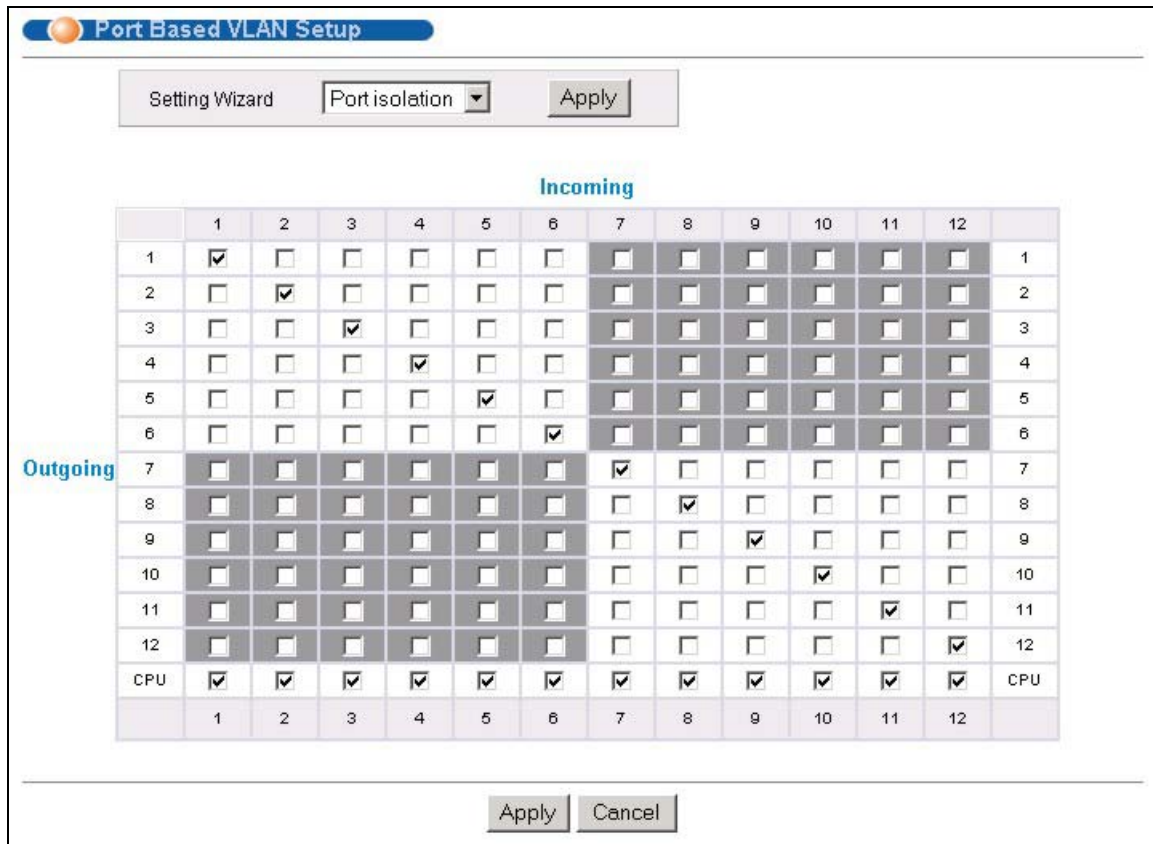

Figure 7-9 Port Based VLAN Setup (Port isolation)

The following table describes the labels in this screen.

Table 7-6 Port Based VLAN Setup

LABEL	DESCRIPTION
Setting Wizard	<p>Choose from All connected or Port isolation.</p> <p>All connected means all ports can communicate with each other, that is, there are no virtual LANs. All incoming and outgoing ports are selected (<i>Figure 7-8</i>). This option is the most flexible but also the least secure.</p> <p>Port isolation means that each port can only communicate with the CPU management port and cannot communicate with each other. All incoming ports are selected while only the CPU outgoing port is selected (<i>Figure 7-9</i>). This option is the most limiting but also the most secure.</p> <p>After you make your selection, click Apply (top right of screen) to display the screens as mentioned above. You can still customize these settings by adding/deleting incoming or outgoing ports, but you must also click Apply at the bottom of the screen.</p>
Incoming	<p>These are the ingress ports; an ingress port is an incoming port, that is, a port through which a data packet enters. If you wish to allow two subscriber ports to talk to each other, you must define the ingress port for both ports. The numbers in the top row denote the incoming port for the corresponding port listed on the left (its outgoing port). CPU refers to the switch management port. By default it forms a VLAN with all Gigabit ports. If it does not form a VLAN with a particular port then the switch cannot be managed from that port.</p>

Table 7-6 Port Based VLAN Setup

LABEL	DESCRIPTION
Outgoing	These are the egress ports; an egress port is an outgoing port, that is, a port through which a data packet leaves. If you wish to allow two subscriber ports to talk to each other, you must define the egress port for both ports. CPU refers to the switch management port. By default it forms a VLAN with all Gigabit ports. If it does not form a VLAN with a particular port then the switch cannot be managed from that port.
Apply	Click Apply to save the changes, including the “wizard settings”.
Cancel	Click Cancel to start configuring the screen again.

Chapter 8

Static MAC Forward Setup

Use these screens to configure static MAC address forwarding.

8.1 Introduction to Static MAC Forward Setup

A static MAC address entry is an address that has been manually entered in the MAC address learning table. Static MAC addresses do not age out. When you set up static MAC address rules, you are setting static MAC addresses for a port. Devices that match static MAC address rules on a port can *only* receive traffic on that port and cannot receive traffic on other ports. This may reduce unicast flooding.

8.2 Configuring Static MAC Forwarding

Click **Static MAC Forwarding** to display the configuration screen as shown.

Figure 8-1 Static MAC Forwarding

The following table describes the labels in this screen.

Table 8-1 Static MAC Forwarding

LABEL	DESCRIPTION
Active	Select this check box to activate your rule. You may temporarily deactivate a rule without deleting it by clearing this check box.
Name	Enter a descriptive name for identification purposes for this static MAC address forwarding rule.
MAC Address	Enter the MAC address in valid MAC address format, that is, six hexadecimal character pairs. Static MAC addresses do not age out.
VID	Enter the VLAN identification number.

Table 8-1 Static MAC Forwarding

LABEL	DESCRIPTION
Port	Select a port where the MAC address entered in the previous field will be automatically forwarded.
Add	Click Add to save the new rule to the switch. It then displays in the summary table at the bottom of the screen.
Cancel	Click Cancel to reset the fields to your previous configuration.
Clear	Click Clear to clear the fields to the factory defaults.

8.3 Viewing and Editing Static MAC Forwarding Rules

To view a summary of the rule configuration, scroll down to the summary table at the bottom of the **Static MAC Forwarding** screen.

To change the settings of a rule, click a number in the **Index** field.

Index	Active	Name	MAC Address	Port	Delete
1	Yes	test	0a:b2:a0:81:f3:7e / 1	3	<input type="checkbox"/>

Figure 8-2 Static MAC Forwarding: Summary Table

The following table describes the labels in this screen.

Table 8-2 Static MAC Forwarding: Summary Table

LABEL	DESCRIPTION
Index	Click an index number to modify a static MAC address rule for a port.
Active	This field displays whether this static MAC address forwarding rule is active (Yes) or not (No). You may temporarily deactivate a rule without deleting it.
Name	This field displays the descriptive name for identification purposes for this static MAC address-forwarding rule.
MAC Address	This field displays the MAC address that will be forwarded and the VLAN identification number to which the MAC address belongs.
Port	This field displays the port where the MAC address shown in the next field will be forwarded.
Delete	Check the rule(s) that you want to remove in the Delete column, then click the Delete button.
Cancel	Click Cancel to clear the selected checkboxes in the Delete column.

Chapter 9

Filtering

This chapter discusses static IP and MAC address port filtering.

9.1 Introduction to Filtering

Filtering means sifting traffic going through the switch based on the source and/or destination MAC addresses and VLAN group (ID).

9.2 Configuring a Filtering Rule

Click **Advanced Application** and **Filtering** to display the screen as shown next.

Figure 9-1 Filtering

The following table describes the related labels in this screen.

Table 9-1 Filtering

LABEL	DESCRIPTION
Active	Make sure to select this check box to activate your rule. You may temporarily deactivate a rule without deleting it by deselecting this check box.
Name	Type a descriptive name for this filter rule. This is for identification purpose only.

Table 9-1 Filtering

LABEL	DESCRIPTION
Action	Select Discard source to drop frame from the source MAC address (specified in the MAC field). The switch can still send frames to the MAC address. Select Discard destination to drop frames to the destination MAC address (specified in the MAC address). The switch can still receive frames originating from the MAC address. Select Discard source and Discard destination to block traffic to/from the MAC address specified in the MAC field.
MAC	Type a MAC address in valid MAC address format, that is, six hexadecimal character pairs.
VID	Type the VLAN group identification number.
Add	Click Add to save the new rule to the switch. It then displays in the summary table at the bottom of the screen.
Cancel	Click Cancel to reset the fields to your previous configuration.
Clear	Click Clear to clear the fields to the factory defaults.

9.3 Viewing and Editing Filter Rules

To view a summary of the rule configuration, scroll down to the summary table at the bottom of the **Filtering** screen.

To change the settings of a rule, click a number in the **Index** field.

Index	Active	Name	MAC Address	Action	Delete
1	Yes	Example	00:a0:c5:00:07:27 / 1	Discard source	<input type="checkbox"/>

Figure 9-2 Filtering: Summary Table

The following table describes the labels in the summary table.

Table 9-2 Filtering: Summary Table

LABEL	DESCRIPTION
Index	This field displays the index number of the rule. Click an index number to edit the rule.
Active	This field displays Yes when the rule is activated and No when is it deactivated.
Name	This field displays the descriptive name for this rule. This is for identification purpose only.
MAC Address	This field displays the source/destination MAC address with the VLAN identification number to which the MAC address belongs.

Table 9-2 Filtering: Summary Table

LABEL	DESCRIPTION
Action	This field displays the filter action.
Delete	Check the rule(s) that you want to remove in the Delete column and then click the Delete button.
Cancel	Click Cancel to clear the selected checkboxes in the Delete column.

Chapter 10 Spanning Tree Protocol

This chapter introduces the Spanning Tree Protocol (STP).

10.1 Introduction to Spanning Tree Protocol (STP)

STP detects and breaks network loops and provides backup links between switches, bridges or routers. It allows a switch to interact with other STP-compliant switches in your network to ensure that only one route exists between any two stations on the network.

10.1.1 STP Terminology

The root bridge is the base of the spanning tree; it is the bridge with the lowest identifier value (MAC address).

Path cost is the cost of transmitting a frame onto a LAN through that port. It is assigned according to the speed of the link to which a port is attached. The slower the media, the higher the cost - see the next table.

Table 10-1 STP Path Costs

	LINK SPEED	RECOMMENDED VALUE	RECOMMENDED RANGE	ALLOWED RANGE
Path Cost	4Mbps	250	100 to 1000	1 to 65535
Path Cost	10Mbps	100	50 to 600	1 to 65535
Path Cost	16Mbps	62	40 to 400	1 to 65535
Path Cost	100Mbps	19	10 to 60	1 to 65535
Path Cost	1Gbps	4	3 to 10	1 to 65535
Path Cost	10Gbps	2	1 to 5	1 to 65535

On each bridge, the root port is the port through which this bridge communicates with the root. It is the port on this switch with the lowest path cost to the root (the root path cost). If there is no root port, then this switch has been accepted as the root bridge of the spanning tree network.

For each LAN segment, a designated bridge is selected. This bridge has the lowest cost to the root among the bridges connected to the LAN.

10.1.2 How STP Works

After a bridge determines the lowest cost-spanning tree with STP, it enables the root port and the ports that are the designated ports for connected LANs, and disables all other ports that participate in STP. Network packets are therefore only forwarded between enabled ports, eliminating any possible network loops.

STP-aware switches exchange Bridge Protocol Data Units (BPDUs) periodically. When the bridged LAN topology changes, a new spanning tree is constructed.

Once a stable network topology has been established, all bridges listen for Hello BPDUs (Bridge Protocol Data Units) transmitted from the root bridge. If a bridge does not get a Hello BPDU after a predefined interval (Max Age), the bridge assumes that the link to the root bridge is down. This bridge then initiates negotiations with other bridges to reconfigure the network to re-establish a valid network topology.

10.1.3 STP Port States

STP assigns five port states (see next table) to eliminate packet looping. A bridge port is not allowed to go directly from blocking state to forwarding state so as to eliminate transient loops.

Table 10-2 STP Port States

PORT STATE	DESCRIPTION
Disabled	STP is disabled (default).
Blocking	Only configuration and management BPDUs are received and processed.
Listening	All BPDUs are received and processed.
Learning	All BPDUs are received and processed. Information frames are submitted to the learning process but not forwarded.
Forwarding	All BPDUs are received and processed. All information frames are received and forwarded.

10.2 STP Status

Click **Advanced Application** and then **Spanning Tree Protocol** in the navigation panel to display the STP status as shown in the screen next.

Spanning Tree Protocol Status [Configuration](#)

Spanning Tree Protocol : Down

Bridge	Root	Our Bridge
Bridge ID	0000-000000000000	0000-000000000000
Hello Time (second)	0	0
Max Age (second)	0	0
Forwarding Delay (second)	0	0
Cost to Bridge	0	
Port ID	0X0000	
Topology Changed Times		0
Time Since Last Change		0:00:00

Polling Interval

Figure 10-1 Spanning Tree Protocol: Status

The following table describes the labels in this screen.

Table 10-3 Spanning Tree Protocol: Status

LABEL	DESCRIPTION
Spanning Tree Protocol	This field displays Running if STP is activated. Otherwise, it displays Down .
Bridge	Root refers to the base of the spanning tree (the root bridge). Our Bridge is this switch. This switch may also be the root bridge.
Bridge ID	This is the unique identifier for this bridge, consisting of bridge priority plus MAC address. This ID is the same for Root and Our Bridge if the switch is the root switch.
Hello Time (second)	This is the time interval (in seconds) at which the root switch transmits a configuration message. The root bridge determines Hello Time , Max Age and Forwarding Delay
Max Age (second)	This is the maximum time (in seconds) a switch can wait without receiving a configuration message before attempting to reconfigure.
Forwarding Delay (second)	This is the time (in seconds) the root switch will wait before changing states (that is, listening to learning to forwarding).
Cost to Bridge	This is the path cost from the root port on this switch to the root switch.

Table 10-3 Spanning Tree Protocol: Status

LABEL	DESCRIPTION
Port ID	This is the priority and number of the port on the switch through which this switch must communicate with the root of the Spanning Tree.
Topology Changed Times	This is the number of times the spanning tree has been reconfigured.
Time Since Last Change	This is the time since the spanning tree was last reconfigured.
Poll Interval(s)	The text box displays how often (in seconds) this screen refreshes. You may change the refresh interval by typing a new number in the text box and then clicking Set Interval .
Stop	Click Stop to halt STP statistic polling.

10.2.1 Configuring STP

To configure STP, click the **Configuration** link in the **Spanning Tree Protocol** screen as shown next.

Spanning Tree Protocol [Status](#)

Active

Bridge Priority

Hello Time Seconds

Max Age Seconds

Forwarding Delay Seconds

Port	Active	Priority	Path Cost
1	<input type="checkbox"/>	128	19
2	<input type="checkbox"/>	128	19
3	<input type="checkbox"/>	128	19
4	<input type="checkbox"/>	128	19
5	<input type="checkbox"/>	128	19
6	<input type="checkbox"/>	128	19
7	<input type="checkbox"/>	128	19
8	<input type="checkbox"/>	128	19
9	<input type="checkbox"/>	128	19
10	<input type="checkbox"/>	128	19
11	<input type="checkbox"/>	128	19
12	<input type="checkbox"/>	128	19

Figure 10-2 Spanning Tree Protocol: Configuration

The following table describes the labels in this screen.

Table 10-4 Spanning Tree Protocol: Configuration

LABEL	DESCRIPTION
Active	Select this check box to activate STP.
Bridge Priority	<p>Bridge priority is used in determining the root switch, root port and designated port. The switch with the highest priority (lowest numeric value) becomes the STP root switch. If all switches have the same priority, the switch with the lowest MAC address will then become the root switch. The allowed range is 0 to 61440.</p> <p>The lower the numeric value you assign, the higher the priority for this bridge.</p> <p>Bridge Priority determines the root bridge, which in turn determines Hello Time, Max Age and Forwarding Delay.</p>
Hello Time	This is the time interval in seconds between BPDU (Bridge Protocol Data Units) configuration message generations by the root switch. The allowed range is 1 to 10 seconds.
Max Age	This is the maximum time (in seconds) a switch can wait without receiving a BPDU before attempting to reconfigure. All switch ports (except for designated ports) should receive BPDUs at regular intervals. Any port that ages out STP information (provided in the last BPDU) becomes the designated port for the attached LAN. If it is a root port, a new root port is selected from among the switch ports attached to the network. The allowed range is 6 to 40 seconds.
Forwarding Delay	<p>This is the maximum time (in seconds) a switch will wait before changing states. This delay is required because every switch must receive information about topology changes before it starts to forward frames. In addition, each port needs time to listen for conflicting information that would make it return to a blocking state; otherwise, temporary data loops might result. The allowed range is 4 to 30 seconds.</p> <p>As a general rule:</p> $2 * (\text{Forward Delay} - 1) \geq \text{Max Age} \geq 2 * (\text{Hello Time} + 1)$
Port	This field displays the port number.
Active	Select this check box to activate STP on this port.
Priority	<p>Configure the priority for each port here.</p> <p>Priority decides which port should be disabled when more than one port forms a loop in a switch. Ports with a higher priority numeric value are disabled first. The allowed range is between 0 and 255 and default value is 128.</p>
Path Cost	Path cost is the cost of transmitting a frame on to a LAN through that port. It is assigned according to the speed of the bridge. The slower the media, the higher the cost - see <i>Table 10-1</i> for more information.
Apply	Click Apply to save your changes back to the switch.
Cancel	Click Cancel to begin configuring this screen afresh.

Chapter 11

Bandwidth Control

This chapter shows you how you can cap the maximum bandwidth allowed from specific source(s) to specified destination(s) using the Bandwidth Control setup screen.

11.1 Introduction to Bandwidth Control

Bandwidth control means defining a maximum allowable bandwidth for incoming and/or out-going traffic flows on a port. Click **Advanced Application** and then **Bandwidth Control** in the navigation panel to bring up the screen as shown next.

Port	Active	Ingress Rate	Egress Rate
1	<input type="checkbox"/>	1 Mbps	1 Mbps
2	<input type="checkbox"/>	1 Mbps	1 Mbps
3	<input type="checkbox"/>	1 Mbps	1 Mbps
4	<input type="checkbox"/>	1 Mbps	1 Mbps
5	<input type="checkbox"/>	1 Mbps	1 Mbps
6	<input type="checkbox"/>	1 Mbps	1 Mbps
7	<input type="checkbox"/>	1 Mbps	1 Mbps
8	<input type="checkbox"/>	1 Mbps	1 Mbps
9	<input type="checkbox"/>	1 Mbps	1 Mbps
10	<input type="checkbox"/>	1 Mbps	1 Mbps
11	<input type="checkbox"/>	1 Mbps	1 Mbps
12	<input type="checkbox"/>	1 Mbps	1 Mbps

Figure 11-1 Bandwidth Control

The following table describes the labels in this screen.

Table 11-1 Bandwidth Control

LABEL	DESCRIPTION
Active	Select this check box to activate bandwidth control.
Port	This field displays the port number.
Active	Make sure to select this check box to activate your rule. You may temporarily deactivate a rule without deleting it by deselecting this check box.

Table 11-1 Bandwidth Control

LABEL	DESCRIPTION
Ingress Rate	Specify the maximum bandwidth allowed in megabits per second (Mbps) for the incoming traffic flow on a port. Enter a number between 1 and 1000.
Egress Rate	Specify the maximum bandwidth allowed in megabits per second (Mbps) for the out-going traffic flow on a port. Enter a number between 1 and 1000.
Apply	Click Apply to save the settings.
Cancel	Click Cancel to reset the fields to your previous configuration.

Part V

Advanced Application 2

This part shows you how to configure the Broadcast Storm Control, Mirroring, Link Aggregation, Port Authentication, Port Security, Access Control and Queuing Method Advanced Application screens.

Chapter 12

Broadcast Storm Control

12.1 Introducing Broadcast Storm Control

Broadcast storm control limits the number of broadcast, multicast and destination lookup failure (DLF) packets the switch receives per second on the ports. When the maximum number of allowable broadcast, multicast and/or DLF packets is reached per second, the subsequent packets are discarded. Enable this feature to reduce broadcast, multicast and/or DLF packets in your network. You can specify limits for each packet type on each port.

12.2 Configuring Broadcast Storm Control

Click **Advanced Application**, **Broadcast Storm Control** in the navigation panel to display the screen as shown next.

Port	Broadcast (pkt/s)	Multicast (pkt/s)	DLF (pkt/s)
1	<input type="checkbox"/> 0	<input type="checkbox"/> 0	<input type="checkbox"/> 0
2	<input type="checkbox"/> 0	<input type="checkbox"/> 0	<input type="checkbox"/> 0
3	<input type="checkbox"/> 0	<input type="checkbox"/> 0	<input type="checkbox"/> 0
4	<input type="checkbox"/> 0	<input type="checkbox"/> 0	<input type="checkbox"/> 0
5	<input type="checkbox"/> 0	<input type="checkbox"/> 0	<input type="checkbox"/> 0
6	<input type="checkbox"/> 0	<input type="checkbox"/> 0	<input type="checkbox"/> 0
7	<input type="checkbox"/> 0	<input type="checkbox"/> 0	<input type="checkbox"/> 0
8	<input type="checkbox"/> 0	<input type="checkbox"/> 0	<input type="checkbox"/> 0
9	<input type="checkbox"/> 0	<input type="checkbox"/> 0	<input type="checkbox"/> 0
10	<input type="checkbox"/> 0	<input type="checkbox"/> 0	<input type="checkbox"/> 0
11	<input type="checkbox"/> 0	<input type="checkbox"/> 0	<input type="checkbox"/> 0
12	<input type="checkbox"/> 0	<input type="checkbox"/> 0	<input type="checkbox"/> 0

Apply Cancel

Figure 12-1 Broadcast Storm Control

The following table describes the labels in this screen.

Table 12-1 Broadcast Storm Control

LABEL	DESCRIPTION
Active	Select this check box to enable broadcast storm control on the switch.
Port	This field displays a port number.
Broadcast (pkt/s)	Select this option and specify how many broadcast packets the port receives per second.
Multicast (pkt/s)	Select this option and specify how many multicast packets the port receives per second.
DLF (pkt/s)	Select this option and specify how many destination lookup failure (DLF) packets the port receives per second.
Apply	Click Apply to save your changes back to the switch.
Cancel	Click Cancel to begin configuring this screen afresh.

Chapter 13

Mirroring

This chapter discusses the Mirror setup screens.

13.1 Introduction to Port Mirroring

Port mirroring allows you to copy traffic going from one or all ports to another or all ports in order that you can examine the traffic from the monitor port (the port you copy the traffic to) without interference.

13.2 Port Mirroring Configuration

Click **Advanced Application**, **Mirroring** in the navigation panel to display the **Mirroring** screen.

You must first select a monitor port. A monitor port is a port that copies the traffic of another port. After you select a monitor port, configure a mirroring rule in the related fields.

Port	Mirrored	Direction
1	<input type="checkbox"/>	Ingress
2	<input type="checkbox"/>	Ingress
3	<input type="checkbox"/>	Ingress
4	<input type="checkbox"/>	Ingress
5	<input type="checkbox"/>	Ingress
6	<input type="checkbox"/>	Ingress
7	<input type="checkbox"/>	Ingress
8	<input type="checkbox"/>	Ingress
9	<input type="checkbox"/>	Ingress
10	<input type="checkbox"/>	Ingress
11	<input type="checkbox"/>	Ingress
12	<input type="checkbox"/>	Ingress

Figure 13-1 Mirroring

The following table describes the related labels in this screen.

Table 13-1 Mirroring

LABEL	DESCRIPTION
Active	Clear this check box to deactivate port mirroring on the switch.
Monitor Port	The monitor port is the port you copy the traffic to in order to examine it in more detail without interfering with the traffic flow on the original port(s). Select this port from this drop-down list box.
Port	This field displays the port number.
Mirrored	Select this option to mirror the traffic on a port.
Direction	Specify the direction of the traffic to mirror. Choices are Egress (outgoing), Ingress (incoming) and Both .
Apply	Click Apply to save the settings.
Cancel	Click Cancel to reset the fields.

Chapter 14

Link Aggregation

This chapter shows you how to logically aggregate physical links to form one logical, higher-bandwidth link.

14.1 Introduction to Link Aggregation

Link aggregation (trunking) is the grouping of physical ports into one logical higher-capacity link. You may want to trunk ports if for example, it is cheaper to use multiple lower-speed links than to under-utilize a high-speed, but more costly, single-port link.

However, the more ports you aggregate then the fewer available ports you have. A link aggregation group is one logical link containing multiple ports.

14.1.1 Dynamic Link Aggregation

The GS-3012 adheres to the 802.3ad standard for static and dynamic (LACP) port trunking.

The GS-3012 supports the link aggregation IEEE802.3ad standard. This standard describes the Link Aggregate Control Protocol (LACP), which is a protocol that dynamically creates and manages trunk groups.

When you enable LACP link aggregation on a port, the port can automatically negotiate with the ports at the remote end of a link to establish trunk groups. LACP also allows port redundancy, that is, if an operational port fails, then one of the “standby” ports become operational without user intervention

Please note that:

- You must connect all ports point-to-point to the same Ethernet switch and configure the ports for LACP trunking.
- LACP only works on full-duplex links.
- All ports in the same trunk group must have the same media type, speed, duplex mode and flow control settings.

Configure trunk groups or LACP before you connect the Ethernet switch to avoid causing network topology loops.

14.1.2 Link Aggregation ID

LACP aggregation ID consists of the following information:

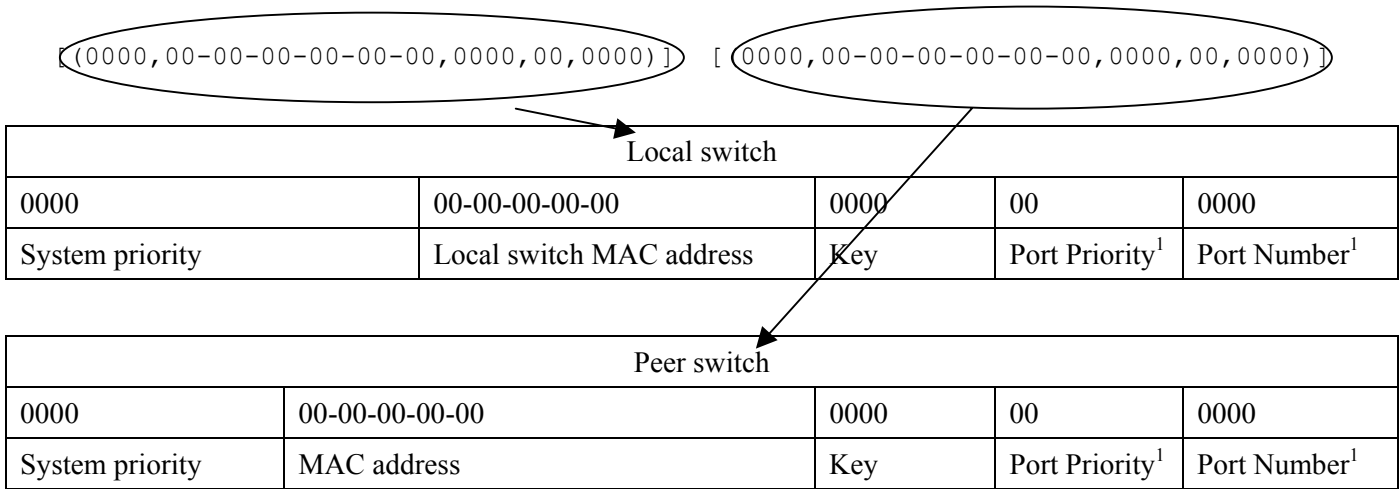

Figure 14-1 Aggregation ID

14.2 Link Aggregation Protocol Status

Click **Advanced Application**, **Link Aggregation** in the navigation panel to display the **Link Aggregation Protocol Status** screen.

Link Aggregation Control Protocol Status
[Configuration](#)

Index	Aggregator ID	Enabled Ports	Synchronized Ports
1	[(0000,00-00-00-00-00-00,0000,00,0000)] [(0000,00-00-00-00-00-00,0000,00,0000)]	-	-
2	[(0000,00-00-00-00-00-00,0000,00,0000)] [(0000,00-00-00-00-00-00,0000,00,0000)]	-	-
3	[(0000,00-00-00-00-00-00,0000,00,0000)] [(0000,00-00-00-00-00-00,0000,00,0000)]	-	-
4	[(0000,00-00-00-00-00-00,0000,00,0000)] [(0000,00-00-00-00-00-00,0000,00,0000)]	-	-
5	[(0000,00-00-00-00-00-00,0000,00,0000)] [(0000,00-00-00-00-00-00,0000,00,0000)]	-	-
6	[(0000,00-00-00-00-00-00,0000,00,0000)] [(0000,00-00-00-00-00-00,0000,00,0000)]	-	-

Polling Interval(s)

Set Interval
Stop

Figure 14-2 Link Aggregation: Link Aggregation Protocol Status

¹ This is “0” as it is the aggregator ID for the link aggregation group, not the individual port.

The following table describes the labels in this screen.

Table 14-1 Link Aggregation: Link Aggregation Protocol Status

LABEL	DESCRIPTION
Index	This field displays the trunk ID to identify a trunk group, that is, one logical link containing multiple ports.
Aggregator ID	Refer to <i>Figure 14-1</i> for more information on this field.
Enabled Port	These are the ports you have configured in the Link Aggregation screen to be in the trunk group.
Synchronized Ports	These are the ports that are currently transmitting data as one logical link in this trunk group.
Poll Interval(s)	The text box displays how often (in seconds) this screen refreshes. You may change the refresh interval by typing a new number in the text box and then clicking Set Interval .
Stop	Click Stop to halt statistic polling.

14.3 Link Aggregation Setup

Click **Configuration** in the **Link Aggregation Protocol Status** screen to display the screen shown next.

You can configure up to six link aggregation groups and each group can aggregate up to eight ports.

Link Aggregation
Status

Link Aggregation Control Protocol

Active

System Priority

Group ID	Active	Dynamic(LACP)
T1	<input type="checkbox"/>	<input type="checkbox"/>
T2	<input type="checkbox"/>	<input type="checkbox"/>
T3	<input type="checkbox"/>	<input type="checkbox"/>
T4	<input type="checkbox"/>	<input type="checkbox"/>
T5	<input type="checkbox"/>	<input type="checkbox"/>
T6	<input type="checkbox"/>	<input type="checkbox"/>

Port	Group	LACP Timeout
1	None ▾	30 ▾ seconds
2	None ▾	30 ▾ seconds
3	None ▾	30 ▾ seconds
4	None ▾	30 ▾ seconds
5	None ▾	30 ▾ seconds
6	None ▾	30 ▾ seconds
7	None ▾	30 ▾ seconds
8	None ▾	30 ▾ seconds
9	None ▾	30 ▾ seconds
10	None ▾	30 ▾ seconds
11	None ▾	30 ▾ seconds
12	None ▾	30 ▾ seconds

Figure 14-3 Link Aggregation: Configuration

The following table describes the labels in this screen.

Table 14-2 Link Aggregation: Configuration

LABEL	DESCRIPTION
Link Aggregation Control Protocol	
Active	Select this checkbox to enable Link Aggregation Control Protocol (LACP).
System Priority	LACP system priority is a number between 1 and 65, 535. The switch with the lowest system priority (and lowest port number if system priority is the same) becomes the LACP “server”. The LACP “server” controls the operation of LACP setup. Enter a number to set the priority of an active port using Link Aggregate Control Protocol (LACP). The smaller the number, the higher the priority level.
Group ID	The field identifies the link aggregation group, that is, one logical link containing multiple ports
Active	Select this option to activate a trunk group.

Table 14-2 Link Aggregation: Configuration

LABEL	DESCRIPTION
Dynamic (LACP)	Select this check box to enable LACP for a trunk.
Port	This field displays the port number.
Group	Select the trunk group to which a port belongs.
LACP Timeout	Timeout is the time interval between the individual port exchanges of LACP packets in order to check that the peer port in the trunk group is still up. If a port does not respond after three tries, then it is deemed to be “down” and is removed from the trunk. Set a short timeout (one second) for busy trunked links to ensure that disabled ports are removed from the trunk group as soon as possible. Select either 1 second or 30 seconds.
Apply	Click Apply to save your changes back to the switch.
Cancel	Click Cancel to begin configuring this screen afresh.

Chapter 15

Port Authentication

This chapter describes the 802.1x authentication method and RADIUS server connection setup.

15.1 Introduction to Authentication

IEEE 802.1x is an extended authentication protocol² that allows support of RADIUS (Remote Authentication Dial In User Service, RFC 2138, 2139) for centralized user profile management on a network RADIUS server.

15.1.1 RADIUS

RADIUS (Remote Authentication Dial-In User Service) authentication is a popular protocol used to authenticate users by means of an external server instead of (or in addition to) an internal device user database that is limited to the memory capacity of the device. In essence, RADIUS authentication allows you to validate an unlimited number of users from a central location.

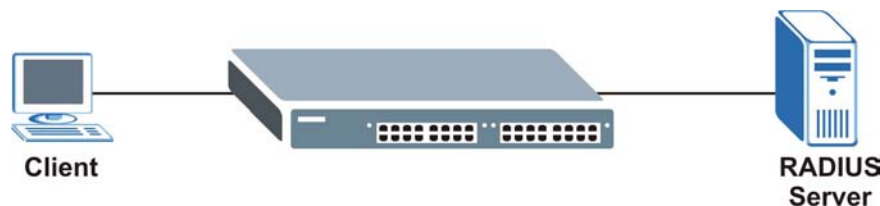

Figure 15-1 RADIUS Server

15.2 Configuring Port Authentication

To enable port authentication, first activate IEEE802.1x security (both on the GS-3012 and the port(s)) then configure the RADIUS server settings.

Click **Port Authentication** under **Advanced Application** in the navigation panel to display the screen as shown.



Figure 15-2 Port Authentication

² At the time of writing, Windows XP of the Microsoft operating systems supports 802.1x. See the Microsoft web site for information on other Windows operating system support. For other operating systems, see its documentation. If your operating system does not support 802.1x, then you may need to install 802.1x client software.

15.2.1 Configuring RADIUS Server Settings

From the **Port Authentication** screen, click **RADIUS** to display the configuration screen as shown.

Figure 15-3 Port Authentication: RADIUS

The following table describes the labels in this screen.

Table 15-1 Port Authentication: RADIUS

LABEL	DESCRIPTION
Authentication Server	
IP Address	Enter the IP address of the external RADIUS server in dotted decimal notation.
UDP Port	The default port of the RADIUS server for authentication is 1812 . You need not change this value unless your network administrator instructs you to do so.
Shared Secret	Specify a password (up to 31 alphanumeric characters) as the key to be shared between the external RADIUS server and the switch. This key is not sent over the network. This key must be the same on the external RADIUS server and the switch.
Apply	Click Apply to save your changes back to the switch.
Cancel	Click Cancel to begin configuring this screen afresh.

15.2.2 Configuring IEEE802.1x

From the **Port Authentication** screen, click **802.1x** to display the configuration screen as shown.

802.1x Port Authentication

Active

Port	Active	Reauthentication	Reauthentication Timer
1	<input type="checkbox"/>	On ▼	3600 seconds
2	<input type="checkbox"/>	On ▼	3600 seconds
3	<input type="checkbox"/>	On ▼	3600 seconds
4	<input type="checkbox"/>	On ▼	3600 seconds
5	<input type="checkbox"/>	On ▼	3600 seconds
6	<input type="checkbox"/>	On ▼	3600 seconds
7	<input type="checkbox"/>	On ▼	3600 seconds
8	<input type="checkbox"/>	On ▼	3600 seconds
9	<input type="checkbox"/>	On ▼	3600 seconds
10	<input type="checkbox"/>	On ▼	3600 seconds
11	<input type="checkbox"/>	On ▼	3600 seconds
12	<input type="checkbox"/>	On ▼	3600 seconds

Apply Cancel

Figure 15-4 Port Authentication: 802.1x

The following table describes the labels in this screen.

Table 15-2 Port Authentication: 802.1x

LABEL	DESCRIPTION
Active	Select this check box to permit 802.1x authentication on the switch.
	You must first allow 802.1x authentication on the switch before configuring it on each port.
Port	This field displays a port number.
Active	Select this checkbox to permit 802.1x authentication on this port. You must first allow 802.1x authentication on the switch before configuring it on each port.
Reauthentication	Specify if a subscriber has to periodically re-enter his or her username and password to stay connected to the port.
Reauthentication Timer	Specify how often a client has to re-enter his or her username and password to stay connected to the port.
Apply	Click Apply to save your changes back to the switch.
Cancel	Click Cancel to begin configuring this screen afresh.

Chapter 16

Port Security

This chapter shows you how to set up port security.

16.1 About Port Security

Port security allows only packets with dynamically learned MAC addresses and/or configured static MAC addresses to pass through a port on the switch. The switch can learn up to 16K MAC addresses in total with no limit on individual ports other than the sum cannot exceed 16K.

For maximum port security, enable this feature, disable MAC address learning and configure static MAC address(es) for a port. It is not recommended you disable **Port Security** together with MAC address learning as this will result in many broadcasts.

16.2 Port Security Setup

Click **Advanced Application, Port Security** in the navigation panel to display the screen as shown.

Port	Active	Address Learning	Limited Number of Learned MAC Address
1	<input type="checkbox"/>	<input checked="" type="checkbox"/>	0
2	<input type="checkbox"/>	<input checked="" type="checkbox"/>	0
3	<input type="checkbox"/>	<input checked="" type="checkbox"/>	0
4	<input type="checkbox"/>	<input checked="" type="checkbox"/>	0
5	<input type="checkbox"/>	<input checked="" type="checkbox"/>	0
6	<input type="checkbox"/>	<input checked="" type="checkbox"/>	0
7	<input type="checkbox"/>	<input checked="" type="checkbox"/>	0
8	<input type="checkbox"/>	<input checked="" type="checkbox"/>	0
9	<input type="checkbox"/>	<input checked="" type="checkbox"/>	0
10	<input type="checkbox"/>	<input checked="" type="checkbox"/>	0
11	<input type="checkbox"/>	<input checked="" type="checkbox"/>	0
12	<input type="checkbox"/>	<input checked="" type="checkbox"/>	0

Figure 16-1 Port Security

The following table describes the labels in this screen.

Table 16-1 Port Security

LABEL	DESCRIPTION
Port	This field displays a port number.
Active	Select this check box to enable port security on this port.
Address Learning	MAC address learning reduces outgoing broadcast traffic. For MAC address learning to occur on a port, the port itself must be active with address learning enabled.
Limited Number of Learned MAC Address	Use this field to limit the number of (dynamic) MAC addresses that may be learned on a port. For example, if you set this field to "5" on port 2, then only the devices with these five learned MAC addresses may access port 2 at any one time. A sixth device would have to wait until one of the five learned MAC addresses aged out. MAC-address aging out time can be set in the Switch Setup screen. The valid range is from "0" to "254". "0" means this feature is disabled, so the switch will learn MAC addresses up to the global limit of 16K.
Apply	Click Apply to save your changes back to the switch.
Cancel	Click Cancel to begin configuring this screen afresh.

Chapter 17

Access Control

This chapter describes how to control access to the switch.

17.1 About Access Control

Click **Advanced Application**, **Access Control** from the navigation panel to display the screen as shown. From this screen you can configure SNMP, up to four web configurator administrators, enable/disable remote service access and configure trusted computers for remote access.



Figure 17-1 Access Control

17.2 Access Control Overview

1. A console port access control session and Telnet access control session cannot coexist. The console port has higher priority. If you telnet to the switch and someone is already logged in from the console port, then you will see the following message.

```
"Local administrator is configuring this device now!!!
Connection to host lost."
```

Figure 17-2 Console Port Priority

2. A console port or Telnet session can coexist with one FTP session, up to five Web sessions (five different usernames and passwords) and/or limitless SNMP access control sessions.

Table 17-1 Access Control Summary

	Console port	Telnet	FTP	Web	SNMP
Number of sessions allowed	1	4	1	5	No limit

Table 17-1 Access Control Summary

	Console port	Telnet	FTP	Web	SNMP
Number of concurrent sessions allowed	1 console port or Telnet. Console port has priority.		1	5	No limit

17.3 About SNMP

Simple Network Management Protocol is a protocol used for exchanging management information between network switches. SNMP is a member of TCP/IP protocol suite. A manager station can manage and monitor the GS-3012 through the network via SNMP version one (SNMPv1) and/or SNMP version 2c. The next figure illustrates an SNMP management operation. SNMP is only available if TCP/IP is configured.

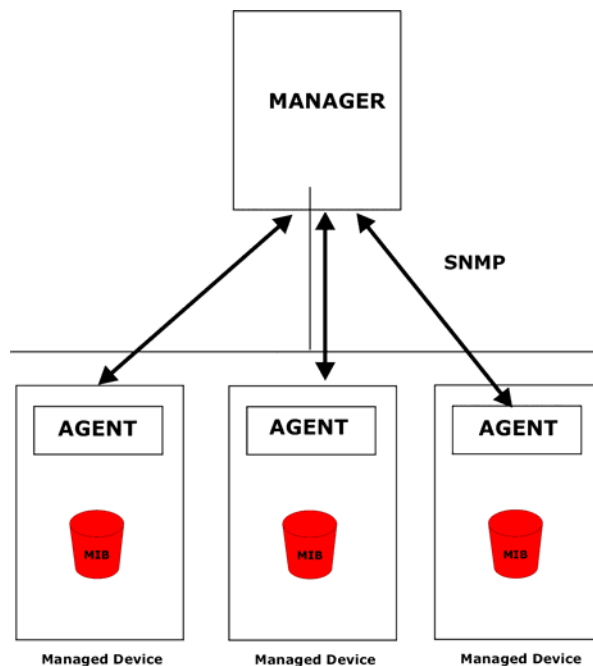
**Figure 17-3 SNMP Management Model**

An SNMP managed network consists of two main components: agents and a manager.

An agent is a management software module that resides in a managed switch (the GS-3012). An agent translates the local management information from the managed switch into a form compatible with SNMP. The manager is the console through which network administrators perform network management functions. It executes applications that control and monitor managed devices.

The managed devices contain object variables/managed objects that define each piece of information to be collected about a switch. Examples of variables include such as number of packets received, node port status etc. A Management Information Base (MIB) is a collection of managed objects. SNMP allows a manager and agents to communicate for the purpose of accessing these objects.

SNMP itself is a simple request/response protocol based on the manager/agent model. The manager issues a request and the agent returns responses using the following protocol operations:

Table 17-2 SNMP Commands

COMMAND	DESCRIPTION
Get	Allows the manager to retrieve an object variable from the agent.
GetNext	Allows the manager to retrieve the next object variable from a table or list within an agent. In SNMPv1, when a manager wants to retrieve all elements of a table from an agent, it initiates a Get operation, followed by a series of GetNext operations.
Set	Allows the manager to set values for object variables within an agent.
Trap	Used by the agent to inform the manager of some events.

17.3.1 Supported MIBs

MIBs let administrators collect statistics and monitor status and performance.

The GS-3012 supports the following MIBs:

- SNMP MIB II (RFC 1213)
- RFC 1157 SNMP v1
- RFC 1493 Bridge MIBs
- RFC 1643 Ethernet MIBs
- RFC 1155 SMI
- SNMPv2, SNMPv2c
- Bridge extension MIBs RFC 2674

17.3.2 SNMP Traps

The GS-3012 sends traps to an SNMP manager when an event occurs. SNMP traps supported are outlined in the following table.

Table 17-3 SNMP Traps

GENERIC TRAP	SPECIFIC TRAP	DESCRIPTION
0 (Cold Start)	0	This trap is sent when the GS-3012 is turned on.
1 (WarmStart)	0	This trap is sent when the GS-3012 restarts.
2 (linkDown)	0	This trap is sent when the Ethernet link is down.
3 (linkUp)	0	This trap is sent when the Ethernet link is up.
4 (authenticationFailure)	0	This trap is sent when an SNMP request comes from non-authenticated hosts.

17.3.3 Configuring SNMP

From the **Access Control** screen, display the **SNMP** screen. You can click **Access Control** to go back to the **Access Control** screen.

Figure 17-4 Access Control: SNMP

The following table describes the labels in this screen.

Table 17-4 Access Control: SNMP

LABEL	DESCRIPTION
Get Community	Enter the get community, which is the password for the incoming Get- and GetNext- requests from the management station.
Set Community	Enter the set community, which is the password for incoming Set- requests from the management station.
Trap Community	Enter the trap community, which is the password sent with each trap to the SNMP manager.
Trap Destination	Enter the IP addresses of up to four stations to send your SNMP traps to.
Apply	Click Apply to save your changes back to the switch.
Cancel	Click Cancel to begin configuring this screen afresh.

17.3.4 Setting Up Login Accounts

Up to five people (one administrator and four non-administrators) may access the switch via web configurator at any one time.

1. An administrator is someone who can both view and configure switch changes. The username for the Administrator is always **admin**. The default administrator password is **1234**.

It is highly recommended that you change the default administrator password ("1234").

2. A non-administrator (username is something other than **admin**) is someone who can view but not configure switch settings.

Click **Access Control** from the navigation panel and then click **Logins** from this screen.

Figure 17-5 Access Control: Logins

The following table describes the labels in this screen.

Table 17-5 Access Control: Logins

LABEL	DESCRIPTION
Administrator	This is the default administrator account with the "admin" user name. You cannot change the default administrator user name. Only the administrator has read/write access.
Old Password	Type the existing system password ("1234" is the default password when shipped).
New Password	Enter your new system password.
Retype to confirm	Retype your new system password for confirmation
Edit Logins	You may configure passwords for up to four users. These people have read-only access.
User Name	Set a user name (up to 32 characters long).
Password	Enter your new system password.
Retype to confirm	Retype your new system password for confirmation
Apply	Click Apply to save your changes back to the switch.
Cancel	Click Cancel to begin configuring this screen afresh.

17.4 SSH Overview

Unlike Telnet or FTP, which transmit data in clear text, SSH (Secure Shell) is a secure communication protocol that combines authentication and data encryption to provide secure encrypted communication between two hosts over an unsecured network.



Figure 17-6 SSH Communication Example

17.5 How SSH works

The following table summarizes how a secure connection is established between two remote hosts.

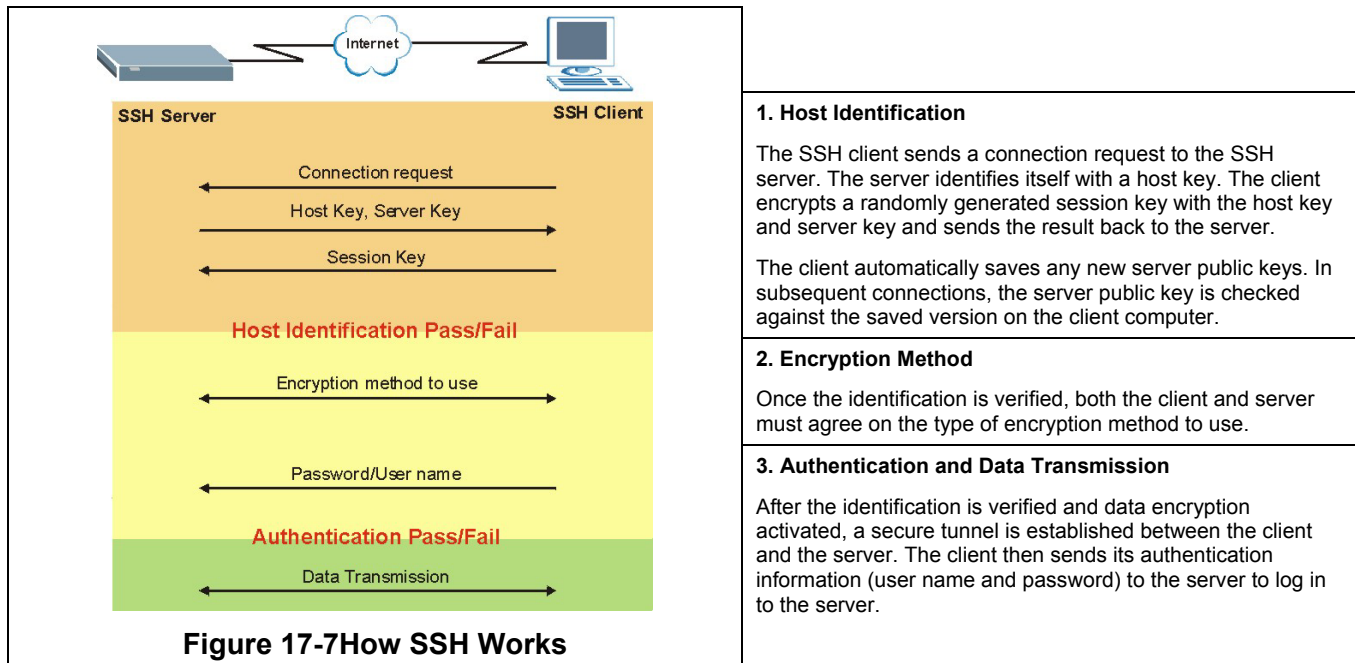

Figure 17-7 How SSH Works

17.6 SSH Implementation

Your switch supports SSH versions 1 and 2 using RSA and DSA authentication and five encryption methods (AES, 3DES, RC4, Blowfish and CAST). The SSH server is implemented on the switch for remote SMT management and file transfer on port 22 (by default). Up to four SSH connections are allowed at a time.

17.6.1 Requirements for Using SSH

You must install an SSH client program on a client computer (Windows or Linux operating system) that is used to connect to the switch over SSH.

17.7 Introduction to HTTPS

HTTPS (HyperText Transfer Protocol over Secure Socket Layer, or HTTP over SSL) is a web protocol that encrypts and decrypts web pages. Secure Socket Layer (SSL) is an application-level protocol that enables secure transactions of data by ensuring confidentiality (an unauthorized party cannot read the transferred data), authentication (one party can identify the other party) and data integrity (you know if data has been changed).

It relies upon certificates, public keys, and private keys.

HTTPS on the switch is used so that you may securely access the switch using the web configurator. The SSL protocol specifies that the SSL server must always authenticate itself to the SSL client (the computer which requests the HTTPS connection with the switch), whereas the SSL client only should authenticate itself when the SSL server requires it to do so.

Please refer to the following figure.

Step 1. HTTPS connection requests from an SSL-aware web browser go to port 443 (by default) on the switch's WS (web server).

Step 2. HTTP connection requests from a web browser go to port 80 (by default) on the switch's WS.

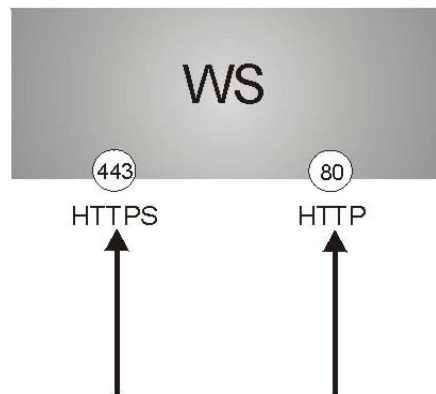

Figure 17-8 HTTPS Implementation

If you disable HTTP in the Service Access Control screen, then the switch blocks all HTTP connection attempts.

17.7.1 HTTPS Example

If you haven't changed the default HTTPS port on the switch, then in your browser enter "https:// switch IP Address/" as the web site address where "switch IP Address" is the IP address or domain name of the switch you wish to access.

The HTTPS proxy server listens on port 443 by default. If you change the HTTPS proxy server port to a different number on the switch, for example 8443, then you must notify people who need to access the switch web configurator to use "https:// switch IP Address:**8443**" as the URL.

17.7.2 Internet Explorer Warning Messages

When you attempt to access the switch HTTPS server, a Windows dialog box pops up asking if you trust the server certificate. Click **View Certificate** if you want to verify that the certificate is from the switch.

You see the following **Security Alert** screen in Internet Explorer. Select **Yes** to proceed to the web configurator login screen; if you select **No**, then web configurator access is blocked.



Figure 17-9 Security Alert Dialog Box (Internet Explorer)

17.7.3 Netscape Navigator Warning Messages

When you attempt to access the switch HTTPS server, a **Website Certified by an Unknown Authority** screen pops up asking if you trust the server certificate. Click **Examine Certificate** if you want to verify that the certificate is from the switch.

If **Accept this certificate temporarily for this session** is selected, then click **OK** to continue in Netscape.

Select **Accept this certificate permanently** to import the switch's certificate into the SSL client.

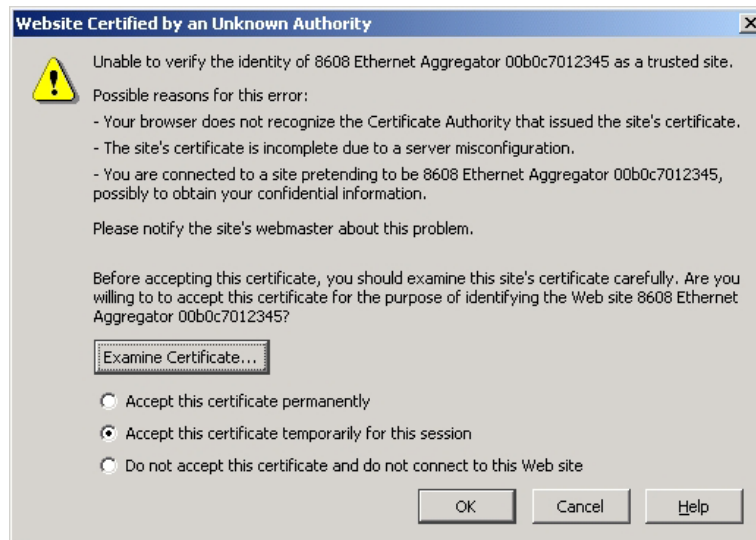

Figure 17-10 Security Certificate 1 (Netscape)



Figure 17-11 Security Certificate 2 (Netscape)

17.7.4 Login Screen

After you accept the certificate and login in, the switch main screen appears. The lock displayed in the bottom right of the browser status bar denotes a secure connection.

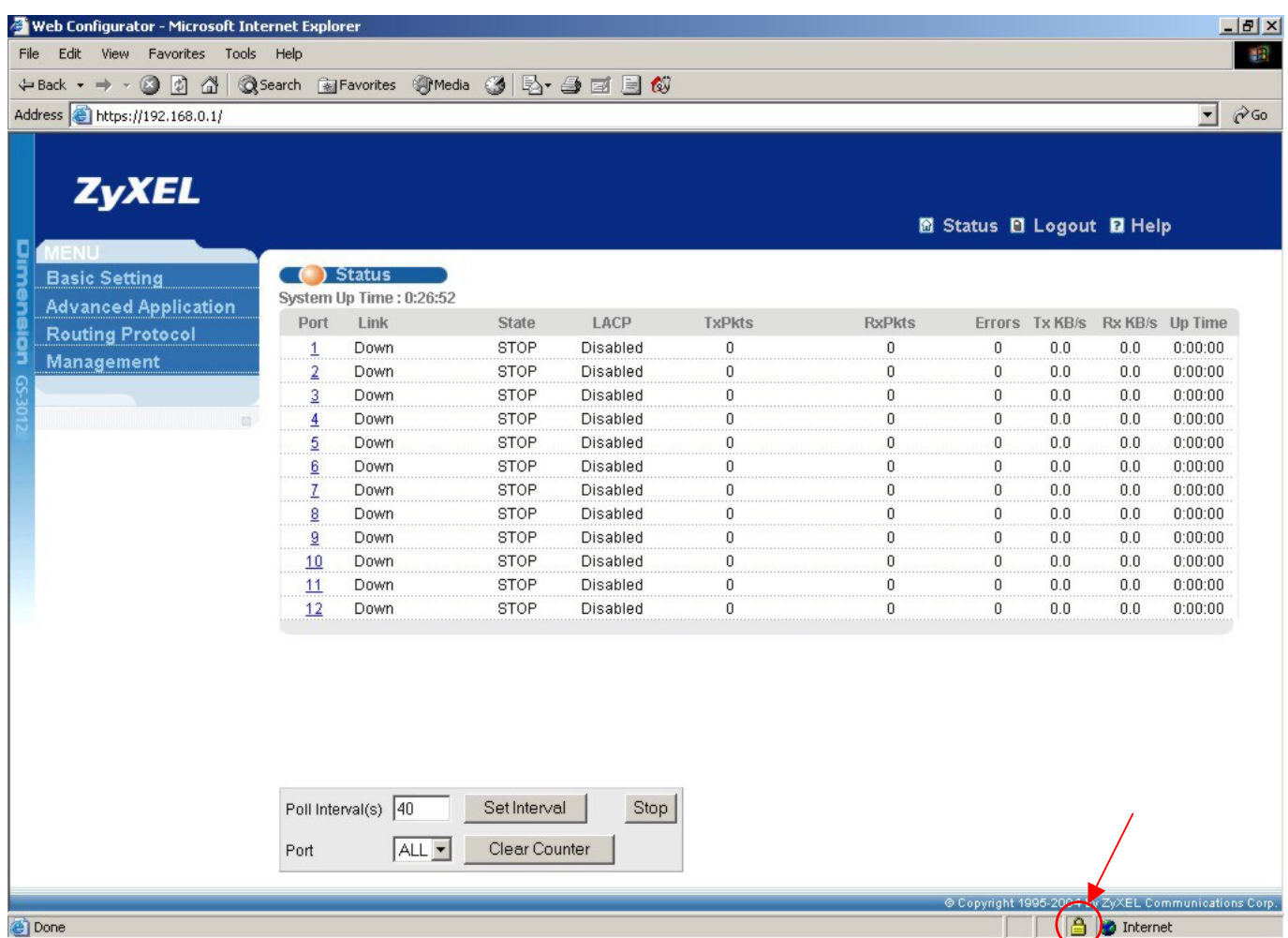

Figure 17-12 Main Screen (Internet Explorer)

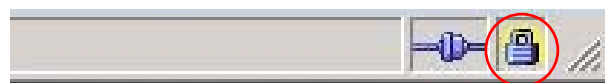

Figure 17-13 Main Screen (Netscape)

17.8 Service Access Control

Service Access Control allows you to decide what services you may use to access the GS-3012. You may also change the default service port and configure “trusted computer(s)” for each service in the **Remote Management** screen (discussed later). Click **Access Control** to go back to the **Access Control** screen.

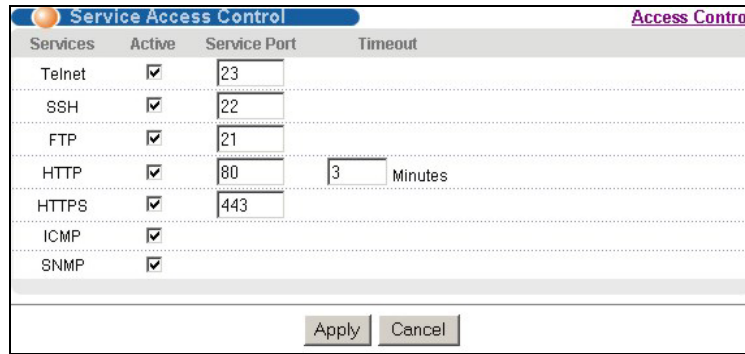

Figure 17-14 Access Control: Service Access Control

The following table describes the fields in this screen.

Table 17-6 Access Control: Service Access Control

LABEL	DESCRIPTION
Services	Services you may use to access the GS-3012 are listed here.
Active	Select this option for the corresponding services that you want to allow to access the GS-3012.
Service Port	For Telnet, SSH, FTP, HTTP or HTTPS services, you may change the default service port by typing the new port number in the Service Port field. If you change the default port number then you will have to let people (who wish to use the service) know the new port number for that service.
Timeout	Type how many minutes a management session (via the web configurator) can be left idle before the session times out. After it times out you have to log in with your password again. Very long idle timeouts may have security risks. A value greater than "0" must be entered.
Apply	Click Apply to save your changes back to the switch.
Cancel	Click Cancel to begin configuring this screen afresh.

17.9 Remote Management

From the **Access Control** screen, display the **Remote Management** screen as shown next.

You can specify a group of one or more “trusted computers” from which an administrator may use a service to manage the switch. Click **Access Control** to return to the **Access Control** screen.

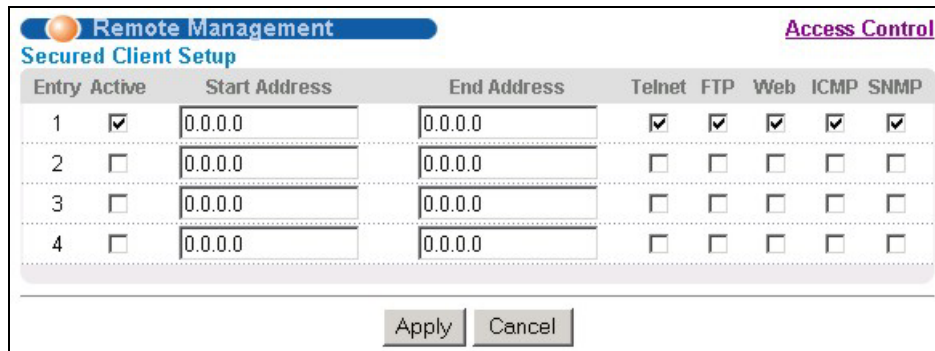

Figure 17-15 Access Control: Remote Management

The following table describes the labels in this screen.

Table 17-7 Access Control: Remote Management

LABEL	DESCRIPTION
Entry	This is the client set index number. A “client set” is a group of one or more “trusted computers” from which an administrator may use a service to manage the switch.
Active	Select this check box to activate this secured client set. Clear the check box if you wish to temporarily disable the set without deleting it.
Start Address End Address	Configure the IP address range of trusted computers from which you can manage this switch. The switch checks if the client IP address of a computer requesting a service or protocol matches the range set here. The switch immediately disconnects the session if it does not match.
Telnet/FTP/Web/ICMP/SNMP	Select services that may be used for managing the switch from the specified trusted computers.
Apply	Click Apply to save your changes back to the switch.
Cancel	Click Cancel to begin configuring this screen afresh.

Chapter 18

Queuing Method

This chapter introduces SPQ and WRR.

18.1 Introduction to Queuing

Queuing is used to help solve performance degradation when there is network congestion. Use the **Queuing Method** screen to configure queuing algorithms for outgoing traffic. See also **Priority Queue Assignment** in **Switch Setup** and **802.1p Priority** in **Port Setup** for related information.

Queuing algorithms allow switches to maintain separate queues for packets from each individual source or flow and prevent a source from monopolizing the bandwidth.

The switch has eight physical queues, Q0 to Q7. Q7 has the highest priority and Q0 has the lowest.

Table 18-1 Physical Queue Priority

QUEUE	PRIORITY
Q7	8 (highest)
Q6	7
Q5	6
Q4	5
Q3	4
Q2	3
Q1	2
Q0	1 (lowest)

18.1.1 Strict Priority Queuing (SPQ)

Strict Priority Queuing (SPQ) services queues based on priority only. As traffic comes into the switch, traffic on the highest priority queue, Q7 is transmitted first. When that queue empties, traffic on the next highest-priority queue, Q6 is transmitted until Q6 empties, and then traffic is transmitted on Q5 and so on. If higher priority queues never empty, then traffic on lower priority queues never gets sent. SPQ does not automatically adapt to changing network requirements.

18.1.2 Weighted Round Robin Scheduling (WRR)

Round Robin Scheduling services queues on a rotating basis and is activated only when a port has more traffic than it can handle. A queue is given an amount of bandwidth irrespective of the incoming traffic on that port. This queue then moves to the back of the list. The next queue is given an equal amount of bandwidth, and then moves to the

end of the list; and so on, depending on the number of queues being used. This works in a looping fashion until a queue is empty.

Weighted Round Robin Scheduling (WRR) uses the same algorithm as round robin scheduling, but services queues based on their priority and queue weight (the number you configure in the **Weight** field – see *Figure 18-1*) rather than a fixed amount of bandwidth. WRR is activated only when a port has more traffic than it can handle. Queues with larger weights get more service than queues with smaller weights. This queuing mechanism is highly efficient in that it divides any available bandwidth across the different traffic queues and returns to queues that have not yet emptied.

18.2 Configuring Queuing

Click **Queuing Method** under **Advanced Application** in the navigation panel.

Port	Method	Weight							
		Q0	Q1	Q2	Q3	Q4	Q5	Q6	Q7
1	<input checked="" type="radio"/> SPQ <input type="radio"/> WRR	1	2	3	4	5	6	7	8
2	<input checked="" type="radio"/> SPQ <input type="radio"/> WRR	1	2	3	4	5	6	7	8
3	<input checked="" type="radio"/> SPQ <input type="radio"/> WRR	1	2	3	4	5	6	7	8
4	<input checked="" type="radio"/> SPQ <input type="radio"/> WRR	1	2	3	4	5	6	7	8
5	<input checked="" type="radio"/> SPQ <input type="radio"/> WRR	1	2	3	4	5	6	7	8
5	<input checked="" type="radio"/> SPQ <input type="radio"/> WRR	1	2	3	4	5	6	7	8
6	<input checked="" type="radio"/> SPQ <input type="radio"/> WRR	1	2	3	4	5	6	7	8
7	<input checked="" type="radio"/> SPQ <input type="radio"/> WRR	1	2	3	4	5	6	7	8
8	<input checked="" type="radio"/> SPQ <input type="radio"/> WRR	1	2	3	4	5	6	7	8
9	<input checked="" type="radio"/> SPQ <input type="radio"/> WRR	1	2	3	4	5	6	7	8
10	<input checked="" type="radio"/> SPQ <input type="radio"/> WRR	1	2	3	4	5	6	7	8
11	<input checked="" type="radio"/> SPQ <input type="radio"/> WRR	1	2	3	4	5	6	7	8
12	<input checked="" type="radio"/> SPQ <input type="radio"/> WRR	1	2	3	4	5	6	7	8

Apply Cancel

Figure 18-1 Queuing Method

The following table describes the labels in this screen.

Table 18-2 Queuing Method

LABEL	DESCRIPTION
Port	This label shows the port you are configuring.

Table 18-2 Queuing Method

LABEL	DESCRIPTION
Method	<p>Select SPQ (Strict Priority Queuing) or WRR (Weighted Round Robin Scheduling).</p> <p>SPQ services queues based on priority only. When the highest priority queue empties, traffic on the next highest-priority queue begins. Q7 has the highest priority and Q0 the lowest.</p> <p>WRR services queues on a rotating basis based on their queue weight (the number you configure in the queue Weight field). Queues with larger weights get more service than queues with smaller weights.</p>
Weight	<p>When you select WRR, enter the queue weight here. Bandwidth is divided across the different traffic queues according to their weights. Queues with larger weights get more service than queues with smaller weights.</p>
Apply	<p>Click Apply to save your changes back to the switch.</p>
Cancel	<p>Click Cancel to begin configuring this screen afresh.</p>

Chapter 19

Classifier

This chapter introduces and shows you how to configure the packet classifier on the GS-3012.

19.1 About the Classifier and QoS

Quality of Service (QoS) refers to both a network's ability to deliver data with minimum delay, and the networking methods used to control the use of bandwidth. Without QoS, all traffic data is equally likely to be dropped when the network is congested. This can cause a reduction in network performance and make the network inadequate for time-critical application such as video-on-demand.

A classifier groups traffic into data flows according to specific criteria such as the source address, destination address, source port number, destination port number or incoming port number. For example, you can configure a classifier to select traffic from the same protocol port (such as Telnet) to form a flow.

Configure QoS on the switch to group and prioritize application traffic and fine-tune network performance. Setting up QoS involves two separate steps:

1. Configure classifiers to sort traffic into different flows.
2. Configure policy rules to define actions to be performed for a classified traffic flow (refer to *Chapter 20* to configure policy rules).

19.2 Configuring the Classifier

Use the **Classifier** screen to define the classifiers. After you define the classifier, you can specify actions (or policy) to act upon the traffic that match the rules. To configure policy rules, refer to *Chapter 20*.

Click **Advanced Application** and **Classifier** in the navigation panel to display the configuration screen as shown.

Figure 19-1 Classifier

The following table describes the labels in this screen.

Table 19-1 Classifier

LABEL	DESCRIPTION
Active	Select this option to enable this rule.
Name	Enter a descriptive name for this rule for identifying purposes.
Packet Format	Specify the format of the packet. Choices are All , 802.3 tagged , 802.3 untagged , Ethernet II tagged and Ethernet II untagged . A value of 802.3 indicates that the packets are formatted according to the IEEE 802.3 standards. A value of Ethernet II indicates that the packets are formatted according to RFC 894, Ethernet II encapsulation.

Table 19-1 Classifier

LABEL	DESCRIPTION
Layer 2 Specify the fields below to configure a layer 2 classifier.	
VLAN	Select Any to classify traffic from any VLAN or select the second option and specify the source VLAN ID in the field provided.
Priority	Select Any to classify traffic from any priority level or select the second option and specify a priority level in the field provided.
Ethernet Type	Select an Ethernet type or select Other and enter the Ethernet type number in hexadecimal value. Refer to <i>Table 19-3</i> for information.
Source	
MAC Address	Select Any to apply the rule to all MAC addresses. To specify a source, select the second choice and type a MAC address in valid MAC address format (six hexadecimal character pairs).
Port	Select the port to which the rule should be applied. You may choose one port only or all ports (All Ports).
Destination	
MAC Address	Select Any to apply the rule to all MAC addresses. To specify a destination, select the second choice and type a MAC address in valid MAC address format (six hexadecimal character pairs).
Layer 3 Specify the fields below to configure a layer 3 classifier.	
DSCP	Select Any to classify traffic from any DSCP or select the second option and specify a DSCP (DiffServ Code Point) number between 0 and 63 in the field provided.
IP Protocol	Select an IP protocol type or select Other and enter the protocol number in decimal value. Refer to <i>Table 19-4</i> for more information. You may select Establish Only for TCP protocol type. This means that the switch will pick out the packets that are sent to establish TCP connections.
Source	
IP Address/Address Prefix	Enter a source IP address in dotted decimal notation. Specify the address prefix by entering the number of ones in the subnet mask.
Socket Number	<p style="text-align: center;">You must select either UDP or TCP in the IP Protocol field before you configure the socket numbers.</p> <hr/> Select Any to apply the rule to all TCP/UDP protocol port numbers or select the second option and enter a TCP/UDP protocol port number.
Destination	
IP Address/Address Prefix	Enter a destination IP address in dotted decimal notation. Specify the address prefix by entering the number of ones in the subnet mask.

Table 19-1 Classifier

LABEL	DESCRIPTION
Socket Number	You must select either UDP or TCP in the IP Protocol field before you configure the socket numbers. Select Any to apply the rule to all TCP/UDP protocol port numbers or select the second option and enter a TCP/UDP protocol port number.
Add	Click Add to insert the entry in the summary table below.
Cancel	Click Cancel to reset the fields back to your previous configuration.
Clear	Click Clear to set the above fields back to the factory defaults.

19.3 Viewing and Editing Classifier Configuration

To view a summary of the classifier configuration, scroll down to the summary table at the bottom of the **Classifier** screen. To change the settings of a rule, click a number in the **Index** field.

When two rules conflict with each other, a higher layer rule has priority over lower layer rule.

Index	Active	Name	Rule	Delete
1	Yes	Example	EtherType = IP; SrcMac = 00:50:ba:ad:4f:81; SrcPort = port 2;	<input type="checkbox"/>

Delete Cancel

Figure 19-2 Classifier: Summary Table

The following table describes the labels in this screen.

Table 19-2 Classifier: Summary Table

LABEL	DESCRIPTION
Index	This field displays the index number of the rule. Click an index number to edit the rule.
Active	This field displays Yes when the rule is activated and No when is it deactivated.
Name	This field displays the descriptive name for this rule. This is for identification purpose only.
Rule	This field displays a summary of the classifier rule's settings.
Delete	Click Delete to remove the selected entry from the summary table.
Cancel	Click Cancel to clear the Delete check boxes.

The following table shows some other common Ethernet types and the corresponding protocol number.

Table 19-3 Common Ethernet Types and Protocol Number

ETHERNET TYPE	PROTOCOL NUMBER
IP ETHII	0800
X.75 Internet	0801

Table 19-3 Common Ethernet Types and Protocol Number

ETHERNET TYPE	PROTOCOL NUMBER
NBS Internet	0802
ECMA Internet	0803
Chaosnet	0804
X.25 Level 3	0805
XNS Compat	0807
Banyan Systems	0BAD
BBN Simnet	5208
IBM SNA	80D5
AppleTalk AARP	80F3

Some of the most common IP ports are:

Table 19-4 Common IP Ports

PORT NUMBER	PORT NAME
21	FTP
23	Telnet
25	SMTP
53	DNS
80	HTTP
110	POP3

19.4 Classifier Example

The following figure shows an example where you configure a classifier that identifies all traffic from MAC address 00:50:ba:ad:4f:81 on port 2.

● **Classifier**

Active

Name

Packet Format

Layer 2

VLAN Any

Priority Any

Ethernet Type IP
 Others (Hex)

Source MAC Any
 MAC : : : : :

Port

Destination MAC Any
 MAC : : : : :

Layer 3

DSCP Any

IP Protocol All Establish Only
 Others (Dec)

Source IP Address / Address /

Prefix

Socket Number Any

Destination IP Address / Address /

Prefix

Socket Number Any

Index	Active	Name	Rule	Delete

Figure 19-3 Classifier: Example

Chapter 20

Policy Rule

This chapter shows you how to configure policy rules.

20.1 About Policy Rules

A classifier distinguishes traffic into flows based on the configured criteria (refer to *Chapter 19* for more information). A policy rule ensures that a traffic flow gets the requested treatment in the network.

20.1.1 DiffServ

DiffServ (Differentiated Services) is a class of service (CoS) model that marks packets so that they receive specific per-hop treatment at DiffServ-compliant network devices along the route based on the application types and traffic flow. Packets are marked with DiffServ Code Points (DSCPs) indicating the level of service desired. This allows the intermediary DiffServ-compliant network devices to handle the packets differently depending on the code points without the need to negotiate paths or remember state information for every flow. In addition, applications do not have to request a particular service or give advanced notice of where the traffic is going.

20.1.2 DSCP and Per-Hop Behavior

DiffServ defines a new DS (Differentiated Services) field to replace the Type of Service (TOS) field in the IP header. The DS field contains a 2-bit unused field and a 6-bit DSCP field which can define up to 64 service levels. The following figure illustrates the DS field.

DSCP is backward compatible with the three precedence bits in the ToS octet so that non-DiffServ compliant, ToS-enabled network device will not conflict with the DSCP mapping.



The DSCP value determines the forwarding behavior, the PHB (Per-Hop Behavior), that each packet gets across the DiffServ network. Based on the marking rule, different kinds of traffic can be marked for different kinds of forwarding. Resources can then be allocated according to the DSCP values and the configured policies.

20.2 Configuring Policy Rules

You must first configure a classifier in the Classifier screen. Refer to *Chapter 19* for more information.

Click **Advanced Applications** and then **Policy Rule** in the navigation panel to display the screen as shown.

Policy

Active

Name

Classifier(s)

Parameters

General: VLAN ID Bandwidth Mbps

EgressPort Out-of-Profile DSCP

Outgoing packet format for Egress port Tag Untag

Priority DSCP TOS

Action

Forwarding

No change
 Discard the packet
 Do not drop the matching frame previously marked for dropping

Priority

No change
 Set the packet's 802.1 priority
 Send the packet to priority queue
 Replace the 802.1 priority field with the IP TOS value

Diffserv

No change
 Set the packet's TOS field
 Replace the IP TOS field with the 802.1 priority value
 Set the Diffserv Codepoint field in the frame

Outgoing

Send the packet to the mirror port
 Send the packet to the egress port
 Send the matching frames(broadcast or DLF, multicast, marked for dropping or to be sent to the CPU) to the egress port
 Set the packet's VLAN ID

Metering

Enable

Out-of-profile action

Drop the packet
 Change the DSCP value
 Do not drop the matching frame previously marked for dropping

Add Cancel Clear

Index	Active	Name	Classifier(s)	Delete
				Delete Cancel

Figure 20-1 Policy

The following table describes the labels in this screen.

Table 20-1 Policy

LABEL	DESCRIPTION
Active	Select this option to enable the policy.
Name	Enter a descriptive name for identification purposes.
Classifier(s)	This field displays the active classifier(s) you configure in the Classifier screen (refer to <i>Chapter 19</i>).

Table 20-1 Policy

LABEL	DESCRIPTION
	Select the classifier(s) to which this policy rule applies. To select more than one classifier, press [SHIFT] and select the choices at the same time.
Parameters Set the fields below for this policy. You only have to set the field(s) that is related to the action(s) you configure in the Action field.	
General	
VLAN ID	Specify a VLAN ID number.
Egress Port	Select an outgoing port.
Outgoing packet format for Egress Port	Select Tag to add the specified VID to packets on the specified outgoing port. Otherwise, select Untag .
Priority	Specify a priority level.
DSCP	Specify a DSCP (DiffServ Code Point) number between 0 and 63.
TOS	Specify the type of service (TOS) priority level.
Metering	
Bandwidth	You can configure the desired bandwidth available to a traffic flow. Traffic that exceeds the maximum bandwidth allocated (in cases where the network is congested) is called out-of-profile traffic.
Out of Profile DSCP	Specify the bandwidth in mega bits per second (Mbps). Enter a number between 1 and 1023.
Out of Profile DSCP	Specify a new DSCP number (between 0 and 63) if you want to replace or remark the DSCP number for out-of-profile traffic.
Action	
Specify the action(s) the switch takes on the associated classified traffic flow.	
Forwarding	
	Select No change to forward the packets. Select Discard packet to drop the packets. Select Do not drop the matching frame previously marked for dropping to retain the frames that were marked to be dropped before.
Priority	
	Select No change to keep the priority setting of the frames. Select Set the packet's 802.1 priority to replace the 802.1 priority field with the value you set in the Priority field. Select Send the packet to priority queue to put the packets in the designated queue. Select Replace the 802.1 priority field with IP TOS value to replace the 802.1 priority field with the value you set in the TOS field.
DiffServ	
	Select No change to keep the TOS and/or DSCP fields in the packets. Select Set the packet's TOS field to set the TOS field with the value you configure in the TOS field. Select Replace the IP TOS with the 802.1 priority value to replace the TOS field with the value you configure in the Priority field. Select Set the Diffserv Codepoint field in the frame to set the DSCP field with the value you configure in the DSCP field.

Table 20-1 Policy

LABEL	DESCRIPTION
Outgoing	Select Send the packet to the mirror port to send the packet to the mirror port. Select Send the packet to the egress port to send the packet to the egress port. Select Send the matching frames (broadcast or DLF, multicast, marked for dropping or to be sent to the CPU) to the egress port to send the broadcast, multicast, DLF, marked-to-drop or CPU frames to the egress port. Select Set the packet's VLANID to set the VLAN ID of the packet with the value you configure in the VLANID field.
Metering	Select Enable to activate bandwidth limitation on the traffic flow(s) then set the actions to be taken on out-of-profile packets.
Out of Profile Action	Select the action(s) to be performed for out-of-profile traffic. Select Drop the packet to discard the out-of-profile traffic. Select Change the DSCP Value to replace the DSCP field with the value specified in the Out of profile DSCP field. Select Do not drop the matching frame previously marked for dropping to queue the frames that are marked to be dropped.
Add	Click Add to inset the entry to the summary table below.
Cancel	Click Cancel to reset the fields back to your previous configuration.
Clear	Click Clear to set the above fields back to the factory defaults.

20.3 Viewing and Editing Policy Configuration

To view a summary of the classifier configuration, scroll down to the summary table at the bottom of the **Policy** screen. To change the settings of a rule, click a number in the **Index** field.

Index	Active	Name	Classifier(s)	Delete
1	Yes	Test	Example;	<input type="checkbox"/>

Figure 20-2 Policy: Summary Table

The following table describes the labels in this screen.

Table 20-2 Policy: Summary Table

LABEL	DESCRIPTION
Index	This field displays the policy index number. Click an index number to edit the policy.
Active	This field displays Yes when policy is activated and No when is it deactivated.
Name	This field displays the descriptive name for this policy. This is for identification purposes only.
Classifier(s)	This field displays the name(s) of the classifier to which this policy applies.

Table 20-2 Policy: Summary Table

LABEL	DESCRIPTION
Delete	Click Delete to remove the selected entry from the summary table.
Cancel	Click Cancel to clear the Delete check boxes.

20.4 Policy Example

The figure below shows an example **Policy** screen where you configure a policy to limit bandwidth and discard out-of-band traffic on a traffic flow classified using the **Example** classifier (refer to *Section 19.4*).

Policy

Active	<input checked="" type="checkbox"/>
Name	Test
Classifier(s)	Example

Parameters

VLAN ID:

EgressPort:

Outgoing packet format for Egress port: Tag Untag

Priority:

DSCP:

TOS:

Metering

Bandwidth: Mbps

Out-of-Profile DSCP:

Action

Forwarding

No change

Discard the packet

Do not drop the matching frame previously marked for dropping

Priority

No change

Set the packet's 802.1 priority

Send the packet to priority queue

Replace the 802.1 priority field with the IP TOS value

Diffserv

No change

Set the packet's TOS field

Replace the IP TOS field with the 802.1 priority value

Set the Diffserv Codepoint field in the frame

Outgoing

Send the packet to the mirror port

Send the packet to the egress port

Send the matching frames(broadcast or DLF, multicast, marked for dropping or to be sent to the CPU) to the egress port

Set the packet's VLAN ID

Metering

Enable

Out-of-profile action

Drop the packet

Change the DSCP value

Do not drop the matching frame previously marked for dropping

Index	Active	Name	Classifier(s)	Delete
1	Yes	Test	Example;	<input type="checkbox"/>

Figure 20-3 Policy Example

Chapter 21

DHCP Relay

This chapter describes the DHCP relay and shows you how to configure the **DHCP Relay** screen.

21.1 Overview

DHCP (Dynamic Host Configuration Protocol, RFC 2131 and RFC 2132) allows individual clients to obtain TCP/IP configuration at start-up from a DHCP server. You can configure the switch to relay client TCP/IP configuration requests to a DHCP server and the server's responses back to the clients.

21.1.1 DHCP “Relay Agent Information Option”

The switch can add information to client TCP/IP configuration requests that it relays to a DHCP server. This helps provide authentication about the source of the requests. You can also specify additional information for the switch to add to the client TCP/IP configuration requests that it relays to the DHCP server. Please refer to RFC 3046 for more details.

21.1.2 DHCP Relay Agent Circuit ID Sub-option Format

The DHCP relay agent information feature adds an Agent Information field to the option 82 field of the DHCP headers of client TCP/IP configuration request frames that the switch relays to a DHCP server. The Agent Information field that the switch adds contains an “Agent Circuit-ID sub-option” that includes the port number, VLAN ID and optional information about the port where the TCP/IP configuration request was received.

21.2 DHCP Relay Configuration

To configure DHCP relay information and specify the DHCP server(s), click **Advanced Application** and **DHCP Relay** to display the screen as shown next.

Figure 21-1 DHCP Relay

The following table describes the labels in this screen.

Table 21-1 DHCP Relay

LABEL	DESCRIPTION
Active	Select this check box to enable DHCP relay.
Remote DHCP Server 1 .. 3	Enter the IP address of a DHCP server in dotted decimal notation.
Relay Agent Information	Select the Option 82 check box to have the switch add the port numbers to client TCP/IP configuration requests that it relays to a DHCP server.
Information	Select the check box to add the switch name to the DHCP client TCP/IP configuration requests that it relays to a DHCP server. This field is read only.
Add	Click Add to inset the entry to the summary table below.
Cancel	Click Cancel to reset the fields back to your previous configuration.

Part VI

Routing Protocol and Management

This part describes the Routing Protocol and Management screens.

Chapter 22

Routing Protocol

This chapter shows you how to configure the routing functions.

22.1 Static Route

Static routes tell the GS-3012 how to forward IP traffic when you configure the TCP/IP parameters manually.

Click **Routing Protocol** in the navigation panel and then **Static Routing** to display the screen as shown.

Figure 22-1 Static Routing

The following table describes the related labels you use to create a static route.

Table 22-1 Static Routing

LABEL	DESCRIPTION
Active	This field allows you to activate/deactivate this static route.
Name	Enter a descriptive name for this route. This is for identification purpose only.
Destination IP Address	This parameter specifies the IP network address of the final destination. Routing is always based on network number. If you need to specify a route to a single host, use a subnet mask of 255.255.255.255 in the subnet mask field to force the network number to be identical to the host ID.
IP Subnet Mask	Enter the subnet mask for this destination.
Gateway IP Address	Enter the IP address of the gateway. The gateway is an immediate neighbor of your switch that will forward the packet to the destination. The gateway must be a router on the same segment as your switch.

Table 22-1 Static Routing

LABEL	DESCRIPTION
Metric	The metric represents the “cost” of transmission for routing purposes. IP routing uses hop count as the measurement of cost, with a minimum of 1 for directly connected networks. Enter a number that approximates the cost for this link. The number need not be precise, but it must be between 1 and 15. In practice, 2 or 3 is usually a good number.
Add	Click Add to save the new rule to the switch. It then displays in the summary table at the bottom of the screen.
Cancel	Click Cancel to reset the fields to your previous configuration.
Clear	Click Clear to clear the fields to the factory defaults.

View the current static routes on the switch in the summary table at the bottom of the screen.

Index	Active	Name	Destination Address	Subnet Mask	Gateway Address	Metric	Delete
1	Yes	ju	172.16.1.2	255.255.0.0	192.168.1.2	2	<input type="checkbox"/>

Delete Cancel

Figure 22-2 Static Routing: Summary Table

The following table describes the labels in the summary table.

Table 22-2 Static Routing: Summary Table

LABEL	DESCRIPTION
Index	This field displays the index number of the route. Click a number to edit the static route entry.
Active	This field displays Yes when the static route is activated and NO when is it deactivated.
Name	This field displays the descriptive name for this route. This is for identification purpose only.
Destination Address	This field displays the IP network address of the final destination.
Subnet Mask	This field displays the subnet mask for this destination.
Gateway Address	This field displays the IP address of the gateway. The gateway is an immediate neighbor of your switch that will forward the packet to the destination.
Metric	This field displays the cost of transmission for routing purposes.
Delete	Check the rule(s) that you want to remove in the Delete column, and then click the Delete button.
Cancel	Click Cancel to clear the selected checkboxes in the Delete column.

Chapter 23

Maintenance

This chapter explains how to configure the maintenance screens. The links on the upper right of the Maintenance screen lead to different screens that let you maintain the firmware and configuration files.

23.1 Maintenance

Click **Management** and then **Maintenance** in the navigation panel to open the following screen.



Figure 23-1 Maintenance

23.2 Firmware Upgrade

Click **Firmware Upgrade** in the **Maintenance** screen if you want to upgrade your switch firmware. See the **System Info** screen to verify your current firmware version number. Make sure you have downloaded (and unzipped) the correct model firmware and version to your computer before uploading to the device.

Be sure to upload the correct model firmware as uploading the wrong model firmware may damage your device.

From the **Maintenance** screen, display the **Firmware Upgrade** screen as shown next.

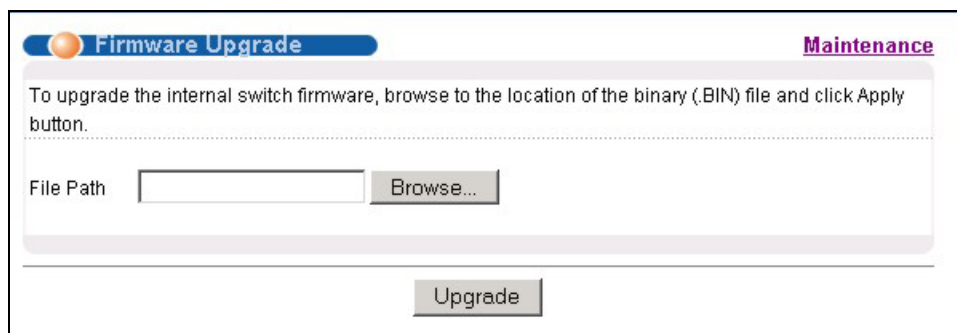

Figure 23-2 Firmware Upgrade

Type the path and file name of the firmware file you wish to upload to the switch in the **File Path** text box or click **Browse** to locate it. After you have specified the file, click **Upgrade**.

23.3 Restore a Configuration File

Restore a previously saved configuration from your computer to the switch using the **Restore Configuration** screen.

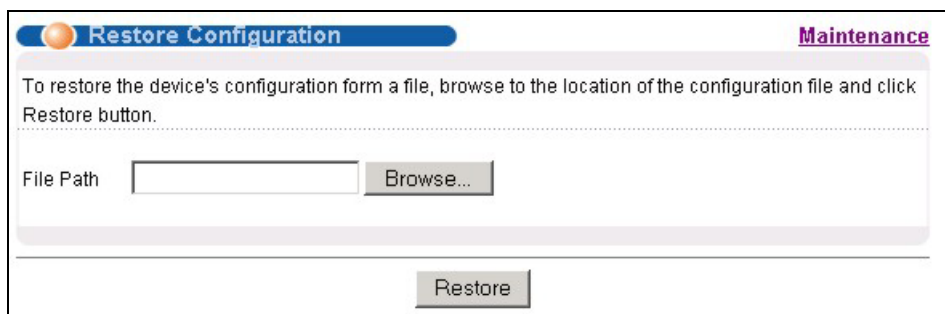

Figure 23-3 Restore Configuration

Type the path and file name of the configuration file you wish to restore in the **File Path** text box or click **Browse** to display a **Choose File** screen from which you can locate it. After you have specified the file, click **Restore**. "config" is the name of the configuration file on the switch, so your backup configuration file is automatically renamed when you restore using this screen.

23.4 Backing Up a Configuration File

Backing up your switch configurations allows you to create various “snap shots” of your device from which you may restore at a later date.

Back up your current switch configuration to a computer using the **Configuration Backup** screen.

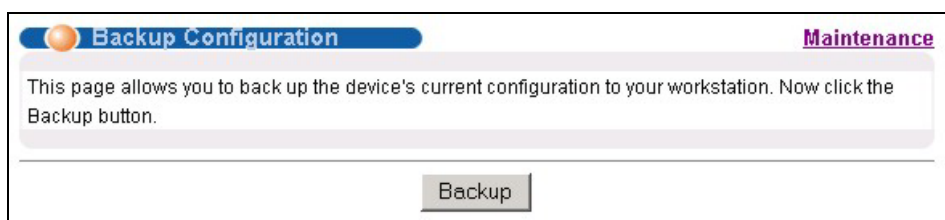

Figure 23-4 Backup Configuration

Follow the steps below to back up the current switch configuration to your computer in this screen.

Step 1. Click **Backup**.

Step 2. Click **Save** to display the **Save As** screen.

Step 3. Choose a location to save the file on your computer from the **Save in** drop-down list box and type a descriptive name for it in the **File name** list box. Click **Save** to save the configuration file to your computer.

23.5 Load Factory Defaults

Press the **Click Here** button next to **Load Factory Defaults** to clear all switch configuration information you configured and return to the factory defaults. The following message appears.

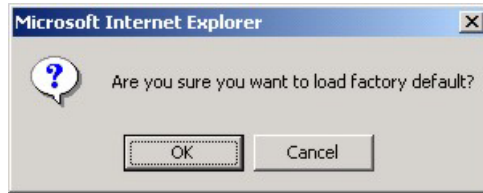

Figure 23-5 Confirm Load factory Defaults

Click **OK** to go to the next screen.

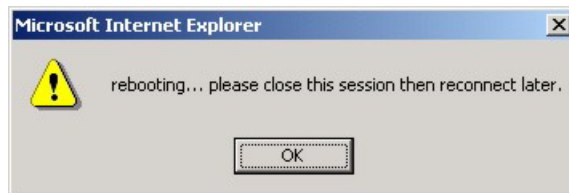

Figure 23-6 Restart Switch After Load Factory Defaults

Click **OK** to begin resetting all switch configurations to the factory defaults and then wait for the switch to restart. This takes up to two minutes. If you want to access the switch web configurator again, you may need to change the IP address of your computer to be in the same subnet as that of the default switch IP address (192.168.1.1).

23.6 Reboot System

Reboot System allows you to restart the switch without physically turning the power off. Press the **Click Here** button next to **Reboot System** to display the next screen.



Figure 23-7 Confirm Restart The Switch

Click **OK** to see the screen as shown in *Figure 23-6*. Click **OK** again and then wait for the switch to restart. This takes up to two minutes. This does not affect the switch's configuration.

23.7 Command Line FTP

This section shows some examples of uploading to or downloading files from the switch using FTP commands. First, understand the filename conventions.

23.7.1 Filename Conventions

The configuration file (often called the romfile or rom-0) contains the factory default settings in the screens such as password, switch setup, IP Setup, etc. Once you have customized the switch's settings, they can be saved back to your computer under a filename of your choosing.

ZyNOS (ZyXEL Network Operating System sometimes referred to as the “ras” file) is the system firmware and has a “bin” filename extension.

Table 23-1 Filename Conventions

FILE TYPE	INTERNAL NAME	EXTERNAL NAME	DESCRIPTION
Configuration File	config		This is the configuration filename on the switch. Uploading the config file replaces the specified configuration file system, including your switch configurations, system-related data (including the default password), the error log and the trace log.
Firmware	Ras	*.bin	This is the generic name for the ZyNOS firmware on the switch.

Example FTP Commands

```
ftp> put firmware.bin ras
```

This is a sample FTP session showing the transfer of the computer file " firmware.bin" to the switch .

```
ftp> get config config.cfg
```

This is a sample FTP session saving the current configuration to a file called “config.cfg” on your computer.

If your (T)FTP client does not allow you to have a destination filename different than the source, you will need to rename them as the switch only recognizes “config” and “ras”. Be sure you keep unaltered copies of both files for later use.

Be sure to upload the correct model firmware as uploading the wrong model firmware may damage your device.

23.7.2 FTP Command Line Procedure

Step 1. Launch the FTP client on your computer.

Step 2. Enter “open”, followed by a space and the IP address of your switch.

Step 3. Press [ENTER] when prompted for a username.

Step 4. Enter your password as requested (the default is “1234”).

Step 5. Enter “bin” to set transfer mode to binary.

Step 6. Use “put” to transfer files from the computer to the switch, for example, “put firmware.bin ras” transfers the firmware on your computer (firmware.bin) to the switch and renames it “ras”. Similarly, “put config.cfg config” transfers the configuration file on your computer (config.cfg) to the switch and

renames it “config”. Likewise “get config config.cfg” transfers the configuration file on the switch to your computer and renames it “config.cfg”. See earlier in this chapter for more information on filename conventions.

Step 7. Enter “quit” to exit the ftp prompt.

23.7.3 GUI-based FTP Clients

The following table describes some of the commands that you may see in GUI-based FTP clients.

Table 23-2 General Commands for GUI-based FTP Clients

COMMAND	DESCRIPTION
Host Address	Enter the address of the host server.
Login Type	Anonymous. This is when a user I.D. and password is automatically supplied to the server for anonymous access. Anonymous logins will work only if your ISP or service administrator has enabled this option. Normal. The server requires a unique User ID and Password to login.
Transfer Type	Transfer files in either ASCII (plain text format) or in binary mode. Configuration and firmware files should be transferred in binary mode.
Initial Remote Directory	Specify the default remote directory (path).
Initial Local Directory	Specify the default local directory (path).

23.7.4 FTP over WAN Restrictions

FTP over WAN will not work when:

- Telnet service is disabled in **Secured Client Sets**.
- The IP address(es) in the **Secured Client Sets** menu does not match the client IP address. If it does not match, the switch will disconnect the Telnet session immediately.

Chapter 24

Diagnostic

This chapter explains the Diagnostic screens.

24.1 Diagnostic

Click **Management** and then **Diagnostic** in the navigation panel to display this screen. Use this screen to check system logs, reset the system or ping IP addresses.

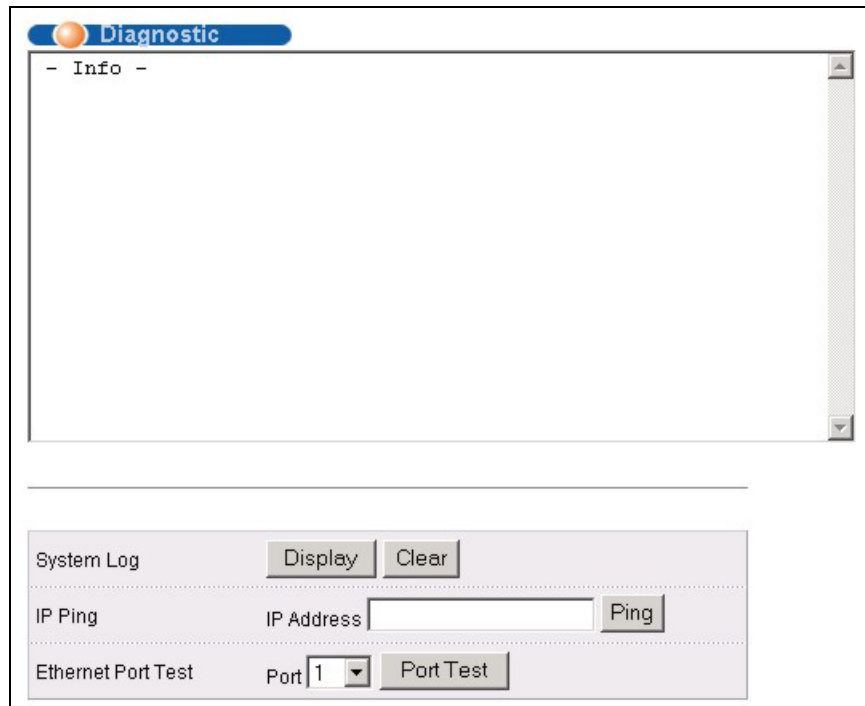

Figure 24-1 Diagnostic

The following table describes the labels in this screen.

Table 24-1 Diagnostic

LABEL	DESCRIPTION
System Log	Click Display to display a log of events in the multi-line text box. Click Clear to empty the text box and reset the syslog entry.
IP Ping	Type the IP address of a device that you want to ping in order to test a connection. Click Ping to have the switch ping the IP address (in the field to the left).
Ethernet Port Test	From the Port drop-down list box, select a port number and click Port Test to perform internal loopback test.

Chapter 25

Cluster Management

This chapter introduces cluster management.

25.1 Introduction to Cluster Management

Cluster Management¹ allows you to manage switches through one switch, called the cluster manager. The switches must be directly connected and be in the same VLAN group so as to be able to communicate with one another.

Table 25-1 ZyXEL Clustering Management Specifications

Maximum number of cluster members	24
Cluster Member Models	Must be compatible with ZyXEL cluster management implementation.
Cluster Manager	The switch through which you manage the cluster member switches.
Cluster Members	The switches being managed by the cluster manager switch.

In the following example, switch A in the basement is the cluster manager and the other switches on the upper floors of the building are cluster members.

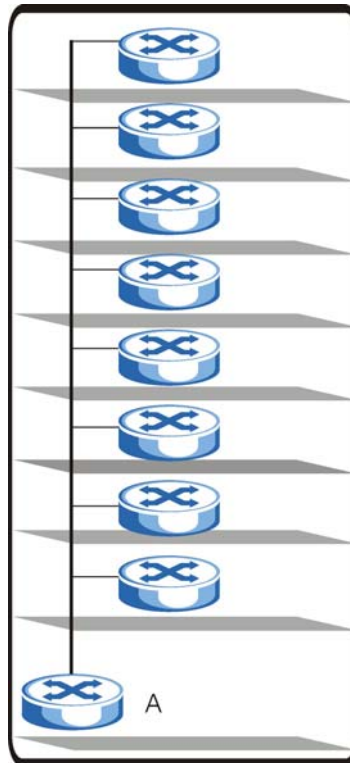

Figure 25-1 Clustering Application Example

¹ Cluster management may also be referred to as “iStacking” in other ZyXEL documentation.

25.2 Cluster Management Status

Click **Management** in the navigation panel and then **Cluster Management** to display the following screen.

Clustering Management Status		Configuration		
Status	Manager			
Manager	00:a0:c5:34:56:35			
The Number Of Member = 2				
Index	MacAddr	Name	Model	Status
1	00:a0:c5:3f:91:5d	ES-4024	ES-4024	Online
2	00:a0:c5:6d:e4:77			Error

Figure 25-2 Cluster Management Status

The following table describes the labels in this screen.

Table 25-2 Cluster Management Status

LABEL	DESCRIPTION
A cluster can only have one manager.	
Status	This field displays the role of this switch within the cluster. <ul style="list-style-type: none"> o Manager o Member (you see this if you access this screen in the cluster member switch directly and not via the cluster manager) o None (neither a manager nor a member of a cluster)
Manager	This field displays the cluster manager switch's hardware MAC Address.
The Number of Member	This field displays the number of switches that make up this cluster. The following fields describe the cluster member switches.
Index	You can manage cluster member switches via the cluster manager switch. Each number in the Index column is a hyperlink leading to the cluster member switch's web configurator (see <i>Figure 25-3</i>).
MacAddr	This is the cluster member switch's hardware MAC Address.
Name	This is the cluster member switch's System Name .
Model	This field displays the model name.

Table 25-2 Cluster Management Status

LABEL	DESCRIPTION
Status	This field displays: <ul style="list-style-type: none"> o Online (the cluster member switch is accessible) o Error (for example the cluster member switch password was changed or the switch was set as the manager and so left the member list, etc.) o Offline (the switch is disconnected - Offline shows approximately 1.5 minutes after the link between cluster member and manager goes down).

25.2.1 Cluster Member Switch Management

Go to the **Clustering Management Status** screen of the cluster manager switch and then select an **Index** hyperlink from the list of members to go to that cluster member switch's web configurator home page. This cluster member web configurator home page and the home page that you'd see if you accessed it directly are different (see *Figure 25-3*).

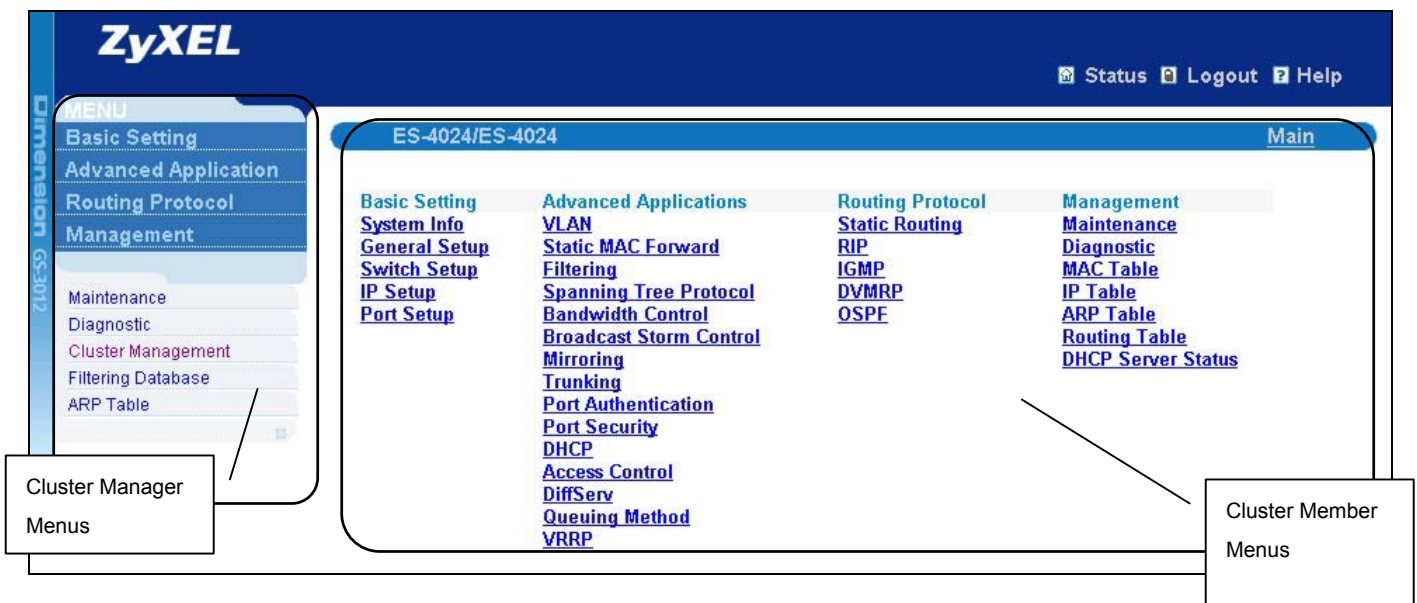
**Figure 25-3 Cluster Member Web Configuration Screen**

Uploading Firmware to a Cluster Member Switch

You can use FTP to upload firmware to a cluster member switch through the cluster manager switch as shown in the following example.

```
C:\>ftp <Cluster Manager IP address>
Connected to <Cluster Manager IP address>
220 GS-3012 FTP version 1.0 ready at Thu Jan 1 00:45:06 1970
User : [Enter]
331 Enter PASS command
Password: <1234 is the default password>
230 Logged in
ftp> ls
200 Port command okay
150 Opening data connection for LIST
--w--w--w- 1 owner group 1907262 Jul 01 12:00 ras
-rw-rw-rw- 1 owner group 393216 Jul 01 12:00 rom-0
--w--w--w- 1 owner group 0 Jul 01 12:00 fw-00-a0-c5-3f-91-5d
-rw-rw-rw- 1 owner group 0 Jul 01 12:00 config-00-a0-c5-3f-91-5d

226 File sent OK
ftp: 462 bytes received in 0.00Seconds 462000.00Kbytes/sec.
ftp> put 350DT3b1.bin fw-00-a0-c5-3f-91-5d
```

Figure 25-4 Example: Uploading Firmware to a Cluster Member Switch

The following table explains some of the FTP parameters.

Table 25-3 FTP Upload to Cluster member Example

FTP PARAMETER	DESCRIPTION
User name	Press [ENTER]
Password	The web configurator password default is 1234.
ls	Enter this command to list the name of cluster member switch's firmware and configuration file.
350DT3b1.bin	The name of the firmware file you want to upload to the cluster member switch.
fw-00-a0-c5-3f-91-5d	The cluster member switch's firmware name as seen in the cluster manager switch.
config-00-a0-c5-3f-91-5d	The cluster member switch's configuration file name as seen in the cluster manager switch.

25.3 Configuring Cluster Management

Click **Configuration** from the **Cluster Management** screen to display the next screen.

Clustering Management Configuration
[Status](#)

Clustering Manager:

Active	<input checked="" type="checkbox"/>
Name	<input type="text" value="1"/>
VID	<input type="text" value="1"/>

Clustering Candidate:

List	<input type="text" value="00:a0:c5:3f:91:51/ES-4024/ES-4024"/>
Password	<input type="text"/>

Index	MacAddr	Name	Model	Remove
1	00:a0:c5:3f:91:5d	ES-4024	ES-4024	<input type="checkbox"/>
2	00:a0:c5:6d:e4:77			<input type="checkbox"/>

Figure 25-5 Configuring Cluster Management

The following table describes the labels in this screen.

Table 25-4 Configuring Cluster Management

LABEL	DESCRIPTION
Clustering Manager	
Active	Select Active to have this switch become the cluster manager switch. A cluster can only have one manager. Other (directly connected) switches that are set to be cluster managers will not be visible in the Clustering Candidates list. If a switch that was previously a cluster member is later set to become a cluster manager, then its Status is displayed as Error in the Cluster Management Status screen and a warning icon () appears in the member summary list below.
Name	Type a name to identify the Clustering Manager . You may use up to 32 printable characters (no spaces are allowed).
VID	This is the Management VLAN ID and is only applicable if the switch is set to 802.1Q VLAN. All switches must be in the same management VLAN group to belong to the same cluster. Switches that are not in the same management VLAN group are not visible in the Clustering Candidates list. This field is ignored if the Clustering Manager is using Port-based VLAN.
Apply	Click Apply to save these changes to the switch.

Table 25-4 Configuring Cluster Management

LABEL	DESCRIPTION
Cancel	Click Cancel to begin configuring this part of the screen afresh.
Clustering Candidate	The following fields relate to the switches that are potential cluster members.
List	A list of suitable candidates found by auto-discovery is shown here. The switches must be directly connected. Directly connected switches that are set to be cluster managers will not be visible in the Clustering Candidate list. Switches that are not in the same management VLAN group will not be visible in the Clustering Candidate list.
Password	<p>Each cluster member's password is its web configurator password. Select a member in the Clustering Candidate list and then enter its web configurator password. If that switch administrator changes the web configurator password afterwards, then it cannot be managed from the Cluster Manager. Its Status is displayed as Error in the Cluster Management Status screen and a warning icon () appears in the member summary list below.</p> <p>If multiple devices have the same password then hold [SHIFT] and click those switches to select them. Then enter their common web configurator password.</p>
Apply	Click Apply to save these changes to the switch.
Cancel	Click Cancel to begin configuring this part of the screen afresh.
Refresh	Click Refresh to perform auto-discovery again to list potential cluster members.
The next summary table shows the devices selected for clustering.	
Index	This is the index number of a cluster member switch.
MAC Address	This is the cluster member switch's hardware MAC address.
Name	This is the cluster member switch's System Name .
Model	This is the cluster member switch's model name.
Remove	Select this checkbox and then click the Remove button to remove a cluster member switch from the cluster.
Cancel	Click Cancel to begin configuring this part of the screen afresh.

Chapter 26

MAC Table

This chapter introduces MAC Table.

26.1 Introduction to MAC Table

The MAC table shows how frames are forwarded or filtered across the switch's ports. It shows what device MAC address, belonging to what VLAN group (if any) is forwarded to which port(s) and whether the MAC address is dynamic (learned by the switch) or static (manually entered in **Static MAC Forwarding**).

The switch uses the Filtering Database to determine how to forward frames. See the following figure.

1. The switch examines a received frame and learns the port on which this source MAC address came.
2. The switch checks to see if the frame's destination MAC address matches a source MAC address already learned in the Filtering Database.
 - If the switch has already learned the port for this MAC address, then it forwards the frame to that port.
 - If the switch has not already learned the port for this MAC address, then the frame is flooded to all ports. Too much port flooding leads to network congestion.
 - If the switch has already learned the port for this MAC address, but the destination port is the same as the port it came in on, then it filters the frame.

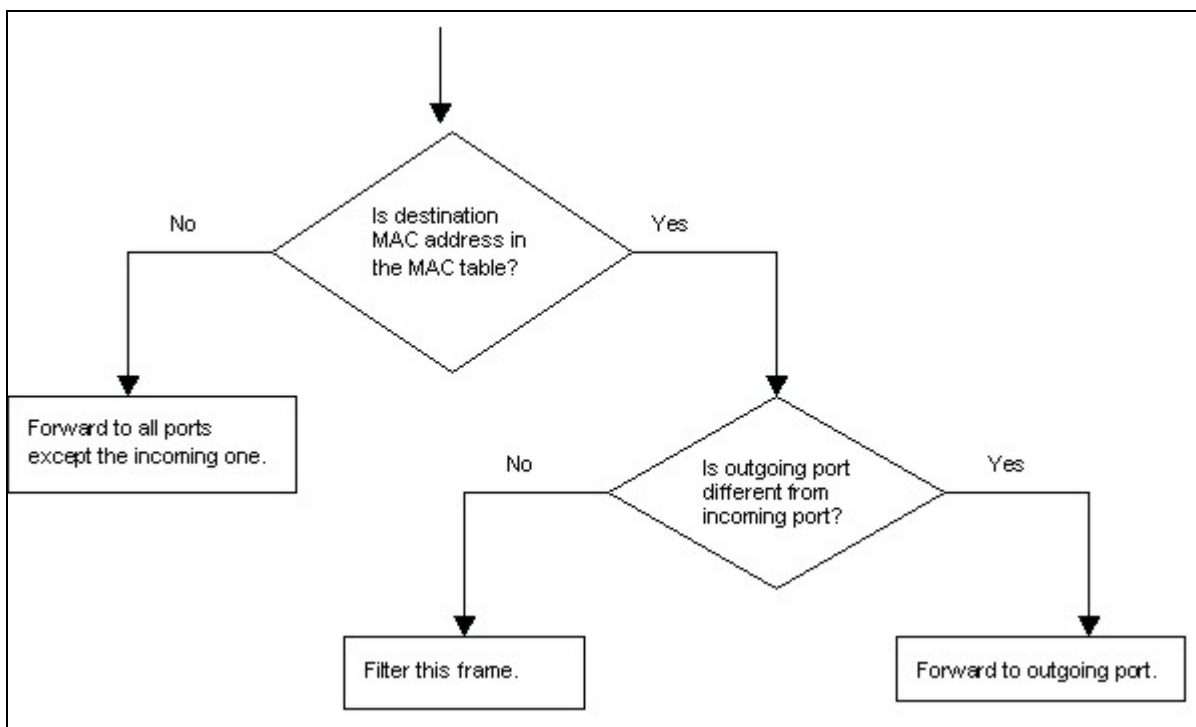

Figure 26-1 MAC Table Flowchart

26.2 Viewing MAC Table

Click **Management** in the navigation panel and then **MAC Table** to display the following screen. The MAC Table can hold up to 16K entries.



MAC Table				
Sort by	MAC	VID	Port	
Index	MAC Address	VID	Port	Type
1	00:00:01:aa:bb:cc	1	4	dynamic
2	00:00:04:a0:00:31	1	4	dynamic
3	00:00:04:a0:00:35	1	4	dynamic
4	00:00:1c:d4:ae:04	1	4	dynamic
5	00:00:85:0b:61:30	1	4	dynamic
6	00:00:86:46:4c:0e	1	4	dynamic
7	00:00:86:46:fc:a4	1	4	dynamic
8	00:00:86:47:0c:66	1	4	dynamic
9	00:00:86:47:11:91	1	4	dynamic
10	00:00:e2:82:90:b5	1	4	dynamic

Figure 26-2 MAC Table

The following table describes the labels in this screen.

Table 26-1 MAC Table

LABEL	DESCRIPTION
Sort by	Click one of the following buttons to display and arrange the data according to that button type. The information is then displayed in the summary table below.
MAC	Click this button to display and arrange the data according to MAC address.
VID	Click this button to display and arrange the data according to VLAN group.
Port	Click this button to display and arrange the data according to port number.
Index	This is the incoming frame index number.
MAC Address	This is the MAC address of the device from which this incoming frame came.
VID	This is the VLAN group to which this frame belongs.
Port	This is the port from which the above MAC address was learned.
Type	This shows whether the MAC address is dynamic (learned by the switch) or static (manually entered in Static MAC Forwarding).

Chapter 27

ARP Table

This chapter introduces ARP Table.

27.1 Introduction to ARP Table

Address Resolution Protocol (ARP) is a protocol for mapping an Internet Protocol address (IP address) to a physical machine address, also known as a Media Access Control or MAC address, on the local area network.

An IP (version 4) address is 32 bits long. In an Ethernet LAN, MAC addresses are 48 bits long. The ARP Table maintains an association between each MAC address and its corresponding IP address.

27.1.1 How ARP Works

When an incoming packet destined for a host device on a local area network arrives at the switch, the switch's ARP program looks in the ARP Table and, if it finds the address, sends it to the device.

If no entry is found for the IP address, ARP broadcasts the request to all the devices on the LAN. The switch fills in its own MAC and IP address in the sender address fields, and puts the known IP address of the target in the target IP address field. In addition, the switch puts all ones in the target MAC field (FF.FF.FF.FF.FF.FF is the Ethernet broadcast address). The replying device (which is either the IP address of the device being sought or the router that knows the way) replaces the broadcast address with the target's MAC address, swaps the sender and target pairs, and unicasts the answer directly back to the requesting machine. ARP updates the ARP Table for future reference and then sends the packet to the MAC address that replied.

27.2 Viewing ARP Table

Click **Management** in the navigation panel and then **ARP Table** to open the following screen. The ARP table can hold up to 500 entries.

ARP Table			
Index	IP Address	MAC Address	Type
1	127.0.0.101	00:a0:c5:32:71:95	dynamic
2	127.0.0.102	00:a0:c5:32:71:97	dynamic
3	127.0.0.103	00:a0:c5:61:28:92	dynamic
4	127.0.0.104	00:a0:c5:ff:12:6c	dynamic
5	127.0.0.105	00:a0:c5:4b:d6:67	dynamic
6	169.254.170.66	00:0b:cd:94:85:00	dynamic
7	172.17.2.1	00:60:b0:d6:e1:ad	dynamic
8	172.17.2.4	00:01:e6:61:26:d4	dynamic
9	172.17.2.6	00:10:83:95:30:a1	dynamic
10	172.17.2.254	00:01:30:b8:16:40	dynamic
11	172.21.0.2	00:05:5d:04:30:f1	dynamic
12	172.21.0.254	00:01:30:b8:16:40	dynamic
13	172.21.1.166	00:02:b3:2c:79:93	dynamic
14	172.21.2.229	00:50:8d:36:37:e2	dynamic
15	172.21.3.6	00:50:8d:36:3c:3b	dynamic
16	172.21.3.7	00:50:ba:ad:75:dd	dynamic
17	172.21.3.11	00:50:8d:af:13:31	dynamic
18	172.21.3.15	00:00:e8:89:88:06	dynamic
19	172.21.3.18	00:50:8d:af:2f:28	dynamic
20	172.21.3.19	00:a0:c5:01:23:46	dynamic
21	172.21.3.20	08:00:46:68:10:58	dynamic
22	172.21.3.21	00:0b:cd:94:89:32	dynamic
23	172.21.3.23	00:00:e2:93:68:06	dynamic
24	172.21.3.25	00:05:5d:e1:6c:cb	dynamic

Figure 27-1 ARP Table

The following table describes the labels in this screen.

Table 27-1 ARP Table

LABEL	DESCRIPTION
Index	This is the ARP Table entry number.
IP Address	This is the learned IP address of a device connected to a switch port with corresponding MAC address below.
MAC Address	This is the MAC address of the device with corresponding IP address above.
Type	This shows whether the MAC address is dynamic (learned by the switch) or static (manually entered in Static MAC Forwarding).

Part VII

Commands

This part gives information on the Command Line Interface (CLI).

Chapter 28

Introducing the Commands

This chapter introduces the commands and gives a summary of commands available.

28.1 Overview

In addition to the web configurator, you can use line commands to configure the switch. Use line commands for advanced switch diagnosis and troubleshooting. If you have problems with your switch, customer support may request that you issue some of these commands to assist them in troubleshooting.

28.1.1 Switch Configuration File

When you configure the switch using either the CLI or web configurator, the settings are saved as a series of commands in a configuration file on the switch. You can perform the following with a configuration file:

- Back up switch configuration once the switch is set up to work in your network.
- Restore switch configuration.
- Use the same configuration file to set all switches (of the same model) in your network to the same settings.

You may also edit a configuration file using a text editor.

Make sure you use valid commands. The switch rejects configuration files with invalid or incomplete commands.

28.2 Accessing the CLI

You can use a direct console connection or Telnet to access the CLI on the switch.

The switch automatically logs you out of the management interface after five minutes of inactivity. If this happens to you, simply log back in again.

28.2.1 Access Priority

- You can only access the CLI with the administrator account (the default username is **admin** and password is **1234**).
- By default, only one concurrent access to the CLI is allowed via either the console port or Telnet. Console port access has higher priority.
- Use the `configure multi-login` command in the configuration mode to allow multiple concurrent logins. However, no more than five concurrent login sessions are allowed.

28.2.2 The Console Port

Connect to the switch's console port using a terminal emulation software configured to the following settings:

- VT100 terminal emulation
- 9600 bps
- No parity
- 8 data bits
- 1 stop bit
- No flow control

Initial Screen

When you turn on your switch, it performs several internal tests as well as line initialization. You can view the initialization information using the console port. After the initialization, the login screen displays (refer to *Section 28.3*).

```
Copyright (c) 1994 - 2004 ZyXEL Communications Corp.
initialize mgmt, ethernet address: 00:13:49:11:22:33
initialize switch, ethernet address: 00:13:49:11:22:34
Initializing switch unit 0...
Press ENTER to continue...
```

Figure 28-1 Initial Console Port Screen

28.2.3 Telnet

Use the following steps to telnet into your switch.

1. For local management, connect your computer to the RJ-45 management port (labeled **MGMT**) on the switch.
2. Make sure your computer IP address and the switch IP address are on the same subnet. In Windows, click **Start** (usually in the bottom left corner), **Run** and then type “telnet 192.168.1.1” (the default management IP address) and click **OK**.
3. A login screen displays (refer to Section 28.3).

28.3 The Login Screen

After you have successfully established a connection to the switch using a direct console connection or Telnet, a login screen displays as shown below. For your first login, enter the default administrator login username “admin” and password “1234”.

```

Enter User Name : admin
Enter Password : XXXX

```

Figure 28-2 CLI: Login Screen

28.4 Command Syntax Conventions

The rules of the commands are listed next.

- The command keywords are in `courier new` font.
- The required fields in a command are enclosed in angle brackets `<>`, for instance, `ping <ip>` means that you must specify an IP number for this command.
- The optional fields in a command are enclosed in square brackets `[]`, for instance, `configure snmp-server [contact <system contact>] [location <system location>]` means that the `contact` and `location` fields are optional.
- “Command” refers to a command used in the command line interface (CLI command).
- The `|` symbol means “or”.
- The entry `<cr>` in the command lines refers to carriage return. Press `[ENTER]` or carriage return after a command to execute the command.
- Use the up (`↑`) or down (`↓`) arrow key to scroll through the command history list.
- The CLI does not accept partial or incomplete commands. You may enter a unique part of a command and press `[TAB]` to have the switch automatically display the full command. For example, if you enter “`config`” and press `[TAB]`, the full command of “`configuration`” automatically displays.
- Each interface refers to a switch Ethernet port. Commands configured after the interface command correspond to those ports.
- Type multiple ports or port ranges separated by a comma. Ranges of port numbers are typed separated by a dash.

28.5 Getting Help

The system includes a help facility to provide you with the following information about the commands:

- List of available commands under a command group.
- Detailed descriptions of the commands.

28.5.1 List of Available Commands

Enter “`help`” to display a list of available commands and the corresponding sub commands.

Enter “`?`” to display a list of commands you can use.

```

GS-3012> help
  Commands available:

  help
  logout
  exit
  history
  enable
  show ip <cr>
  show hardware-monitor <C|F>
  show system-information
  ping <ip|host-name> <cr>
  ping <ip|host-name> [vlan <vlan-id>][..]
  ping help
  traceroute <ip|host-name> <cr>
  traceroute <ip|host-name> [vlan <vlan-id>][..]
  traceroute help
  ssh <1|2> <[user@]dest-ip> <cr>
  ssh <1|2> <[user@]dest-ip> [command </>]
GS-3012>

```

Figure 28-3 CLI Help: List of Commands: Example 1

```

GS-3012> ?
  enable          Turn on privileged commands
  exit           Exit from the EXEC
  help           Description of the interactive help system
  history        Show a list of previously run commands
  logout         Exit from the EXEC
  ping           Exec ping
  show           Show system information
  ssh            SSH client
  traceroute     Exec traceroute
GS-3012>

```

Figure 28-4 CLI Help: List of Commands: Example 2

28.5.2 Detailed Command Information

Enter <command> help to display detailed sub command and parameters.

Enter <command> ? to display detailed help information about the sub commands and parameters.

```

GS-3012> ping help
  Commands available:

  ping <ip>
  <
  [ in-band|out-of-band|vlan <vlan-id> ]
  [ size <0-1472> ]
  [ -t ]
  >
GS-3012>

```

Figure 28-5 CLI Help: Detailed Command Information: Example 1

```

GS-3012> ping ?
GS-3012> ping ?
  <ip|host-name>      destination ip address
  help                Description of ping help

```

Figure 28-6 CLI: Help: Detailed Command Information: Example 2

28.6 Command Modes

There are three CLI command modes: User, Enable and Configure.

When you first log into the CLI, the initial command mode is the User mode. The User mode commands are a subset of the Enable mode commands. The User mode command prompt ends with an angle bracket (>).

To enter Enable (or privileged) mode, type “enable” and enter a password when prompted (the default is 1234). When you enter the Enable mode, the command prompt changes to the pound sign (#).

To enter the configuration mode, type “configuration” or “config”. The Configure mode command prompt consists of the word “config” and the pound sign (#). There are two sub configuration modes: VLAN and interface. To enter config-vlan mode, type “vlan” followed by a number (between 1 to 4094). For example, `vlan 10`. To enter config-interface mode, enter `interface` followed by a port number. For example, `interface 10`.

Enter “exit” or “logout” to quit from the current mode or log out from the CLI.

28.7 Using Command History

The switch keeps a list of up to 256 commands(s) you have entered for the current CLI session. You can use any commands in the history again by pressing the up (▲) or down (▼) arrow key to scroll through the previously used commands and press [ENTER]. Use the history command to display the list of commands.

```
GS-3012> history
enable
Exit
show ip
history
GS-3012>
```

Figure 28-7 CLI: History Command Example

28.8 Saving Your Configuration

After you set the switch settings with the configuration commands, use the `write memory` command to save the changes permanently to the configuration file that you are using.

```
GS-3012# write memory
```

Figure 28-8 CLI: write memory

The `write memory` command is not available in User mode.

You must save your changes after each CLI session. All unsaved configuration changes are lost once you restart the switch.

28.8.1 Logging Out

In User mode, enter the `exit` or `logout` command to log out of the CLI.

28.9 Command Summary

The following sections summarize the commands available in the switch together with a brief description of each command. Commands listed in the tables are in the same order as they are displayed in the CLI. See the related section in the User's Guide for more background information.

28.9.1 User Mode

The following table describes the commands available for User mode.

Table 28-1 Command Summary: User Mode

COMMAND		DESCRIPTION
help		Displays help information.
logout		Exits from the CLI.
exit		Logs out from the CLI.
history		Displays a list of previously command(s) that you have executed. The switch stores up to 256 commands in history.
enable		Accesses Enable (or privileged) mode.
show		
	hardware-monitor <C F>	Displays current hardware monitor information with the specified temperature unit (Celsius C or Fahrenheit F).
	ip	Displays IP related information.
	system-information	Displays general system information.
ping	<IP host-name> [<in-band out-of-band vlan <vlan-id>] [size <0-1472>] [-t]	Sends a Ping request to an Ethernet device.
traceroute	<ip host-name> [in-band out-of-band vlan <vlan-id>] [ttl <1-255>] [wait <1-60>] [queries <1-10>]	Determines the path a packet takes to a device.
ssh	<1 2> <[user@]dest-ip>	Connects to an SSH server with the specified SSH version.

28.9.2 Enable Mode

The following table describes the commands available for Enable mode.

Table 28-2 Command Summary: Enable Mode

COMMAND		DESCRIPTION	
help		Displays help information.	
logout		Exits Enable (or privileged) mode.	
exit		Exits Enable (or privileged) mode.	
history		Displays a list of command(s) that you have previously executed.	
enable		Accesses Enable (or privileged) mode.	
disable		Exits Enable (or privileged) mode.	
configure		Accesses Configuration mode.	
no	logging	Clears the system log.	
	arp	Flushes the ARP (Address Resolution Protocol) table.	
	interface <port-number>	Clears the interface status of the specified port(s).	
show			
	ip	Displays IP related information.	
	ip arp	Displays the ARP table.	
	ip route	Displays IP routing information.	
	ip route static	Displays IP static route information.	
	hardware-monitor <C F>	Displays current hardware monitor information with the specified temperature unit (Celsius C or Fahrenheit F).	
	system-information	Displays general system information.	
	vlan1q	gvrp	Displays GVRP setting.
		port-isolation	Displays port isolation setting.
	spanning-tree	config	Displays Spanning Tree Protocol (STP) settings.
	mac	address-table static	Displays static MAC address table.
		address-table <all> <mac vid port>	Displays MAC address table. You can sort by MAC address, VID or port.
	lacp		Displays Link Aggregation Control Protocol information.
	trunk		Displays link aggregation information.
	radius-server		Displays RADIUS server settings.
	port-access-authenticator		Displays all port authentication settings.

Table 28-2 Command Summary: Enable Mode

COMMAND		DESCRIPTION
	[port-list]	Displays port authentication settings on the specified port(s).
port-security		Displays all port security settings.
	[port-list]	Displays port security settings on the specified port(s).
snmp-server		Displays SNMP settings.
logins		Displays login account information.
service-control		Displays service control settings.
remote-management		Displays all secured client information.
	[index]	Displays specified secured client information.
classifier		Displays all classifier related information.
	[name]	Displays specified classifier related information.
policy		Displays all policy related information.
	[name]	Displays specified policy related information.
interface <port-number>		Displays current interface status.
interfaces config <port-list>		Displays current interface configuration.
	bandwidth-control	Displays bandwidth control settings.
	egress	Displays outgoing port information.
	bstorm-control	Displays broadcast storm control settings.
vlan		Displays the status of all VLANs.
	<vlan-id>	Displays the status of the specified VLAN.
running-config		Displays current operating configuration.
timesync		Displays time server information.
time		Displays current system time and date.
garp		Displays GARP information.
loginPrecedence		Displays login precedence settings.
logging		Displays system logs.
ssh		Displays general SSH settings.
	known-hosts	Displays known SSH hosts information.

Table 28-2 Command Summary: Enable Mode

COMMAND		DESCRIPTION
	key <rsa rsa dsa>	Displays the SSH public and private keys
	session	Displays current SSH session(s).
	https	Displays the HTTPS information.
	session	Displays current HTTPS session(s).
	certificate	Displays the HTTPS certificates.
	key <rsa dsa>	Displays the HTTPS key.
	timeout	Displays the HTTPS session timeout.
	multi-login	Displays multi-login information
	plt	Displays Packet Loop Test (PLT).
	mac-aging-time	Displays MAC learning aging time.
	cluster	Displays cluster management status.
	candidates	Displays cluster candidate information.
	member mac <mac-addr>	Displays the MAC address of the cluster member(s).
	member	Displays the status of the cluster member(s).
	members config	Displays the configuration of the cluster member(s).
mac-flush		Clears the MAC address table.
	<port-num>	Removes all learned MAC address on the specified port(s).
erase	running-config	Resets to the factory default settings.
boot	config <index>	Performs a system cold start, checks the hardware and restarts using the specified configuration file.
reload	config <index>	Performs a system warm start, checks the configuration and restarts using the specified configuration file.
write	memory	Saves the configuration to the configuration file the switch is currently using.
	<index>	Saves the configuration to the specified configuration file on the switch.
copy	running-config tftp <ip> <remote-file>	Backs up running configuration to the specified TFTP server with the specified file name.

Table 28-2 Command Summary: Enable Mode

COMMAND			DESCRIPTION
	tftp	config <ip> <remote-file>	Restores configuration with the specified filename from the specified TFTP server.
		flash <ip> <remote-file>	Restores firmware via TFTP.
ping	<ip host-name> [<in-band out-of-band vlan <vlan-id>] [size <0-1472>] [-t]		Sends a Ping request to an Ethernet device.
traceroute	<ip host-name> [in-band out-of-band vlan <vlan-id>] [ttl <1-255>] [wait <1-60>] [queries <1-10>]		Determines the path a packet takes to a device.
ssh	<1 2> <[user@]dest-ip>		Connects to an SSH server with the specified SSH version.

28.9.3 Configure Mode

The following table lists the commands in Configuration (or Config) mode.

Table 28-3 Command Summary: Configure Mode

COMMAND			DESCRIPTION
help			Displays help information.
logout			Exits from the CLI.
history			Displays a list of previously command(s) that you have executed.
exit			Exits from the CLI.
mode	zynos		Changes the CLI mode to the ZyNOS format.
password			Change the password for Enable mode.
no	ip		Sets the management IP address to the default value.
		route <ip> <mask> inactive	Enables a specified IP static route.
		route <ip> <mask>	Removes a specified IP static route.

Table 28-3 Command Summary: Configure Mode

COMMAND		DESCRIPTION
mac-forward	name <name> mac <mac-addr> vlan <vlan-id> interface <interface-id> inactive	Enables the specified MAC address, belonging to a VLAN group (if any) forwarded through an interface(s).
	name <name> mac <mac-addr> vlan <vlan-id> interface <interface-id>	Removes the specified MAC forwarding entry, belonging to a VLAN group (if any) forwarded through an interface(s).
mac-filter	name <name> mac <mac-addr> vlan <vlan-id> drop inactive	Enables the specified MAC-filter rule.
	name <name> mac <mac-addr> vlan <vlan-id> drop	Disables the specified MAC filter rule.
mirror-port		Disables port mirroring on the switch.
lacp		Disables the link aggregation control protocol (dynamic trunking) on the switch.
trunk	<T1 T2 T3 T4 T5 T6> lacp	Disables LACP in the specified trunk group.
	<T1 T2 T3 T4 T5 T6> interface <port-list>	Removes ports from the specified trunk group.
	<T1 T2 T3 T4 T5 T6> <cr>	Disables the specified trunk group.
igmp-snooping		Disables IGMP snooping.
bcp-transparency		Disables bridging control protocol transparency such as STP.
storm-control		Disables broadcast storm control.
bandwidth-control		Disables bandwidth control.
vlanlq	gvrp	Disables GVRP on the switch.
	port-isolation	Disables port isolation.
spanning-tree		Disables STP.
	<port-list>	Disables STP on listed ports.
timesync		Disables the time setting on the timeserver.
radius-server		Disables the use of authentication from the RADIUS server.
port-access-authenticator		Disables port authentication on the switch.

Table 28-3 Command Summary: Configure Mode

COMMAND		DESCRIPTION
	<port-list> reauthenticate	Disables the re-authentication mechanism on the listed port(s).
	<port-list>	Disables authentication on the listed ports.
port-security	<port-list>	Disables port security on the specified ports.
	<port-list> learn inactive	Enables MAC address learning on the specified ports.
snmp-server	trap-destination <ip>	Disables sending of SNMP traps to a station.
logins	<name>	Disables login access to the specified name.
service-control	telnet	Disables telnet access to the switch.
	ftp	Disables FTP access to the switch.
	http	Disables web browser control to the switch.
	ssh	Disables SSH (Secure Shell) server access to the switch.
	https	Disables secure web browser access to the switch.
	icmp	Disables ICMP access to the switch such as pinging and tracerouting.
	snmp	Disables SNMP management.
remote-management	<index>	Clears a secure client set entry from the list of secure clients.
	<index> service <telnet ftp http ic mp snmp>	Disables a secure client set entry number from using the selected remote management service(s).
classifier	<name>	Deletes the classifier. Each classifier has one rule. If you delete a classifier you cannot use policy rule related information.
	<name> inactive	Enables a classifier.
policy	<name>	Deletes the policy. A policy sets actions for classifier traffic.
	<name> inactive	Enables a policy.
vlan	<vlan-id>	Deletes the static VLAN entry.
dhcp-relay		Disables DHCP relay.

Table 28-3 Command Summary: Configure Mode

COMMAND		DESCRIPTION
	option	Disables the relay agent information option 82.
	information	System name is not appended to option 82 information field.
	cluster	Disables cluster management on the switch.
	member <mac-address>	Removes the cluster member.
ssh	key <rsa1 rsa dsa>	Deletes the secure shell server encryption key and regenerates a new key. Your switch supports SSH versions 1 and 2 using RSA and DSA authentication.
	known-hosts <host-ip> <cr>	Removes the specified remote hosts from the list of all known hosts.
	known-hosts <host-ip> [1024 ssh-rsa ssh-dsa]	Removes remote known hosts with the specified public key (1024-bit RSA1, RSA or DSA).
	https timeout	Resets the session timeout to the default of 300 seconds.
	multi-login	Disables another administrator from logging into Telnet or the CLI.
vlan-type	<802.1q port-based>	Specifies the VLAN type.
ip	route <ip> <mask> <next-hop-ip>	Creates a static route.
	<ip> <mask> <next-hop-ip> [metric <metric>] [name <name>] [inactive]	Sets the metric of a static route or deactivates a static route.
	name-server <ip>	Sets the IP address of a domain name server.
	address default-gateway <ip>	Sets the default gateway's IP address for the out-of-band management port.
	address <ip> <mask>	Sets the IP address and subnet mask of the out-of-band management port.
mac-forward	name <name> mac <mac-addr> vlan <vlan-id> interface <interface-id>	Configures a static MAC address forwarding rule.

Table 28-3 Command Summary: Configure Mode

COMMAND		DESCRIPTION	
	name <name> mac <mac-addr> vlan <vlan-id> interface <interface-id> inactive	Disables a static MAC address forwarding rule.	
mac-filter	name <name> mac <mac-addr> vlan <vlan-id> drop <src/dst/both>	Configures a static MAC address port filtering rule.	
	name <name> mac <mac-addr> vlan <vlan-id> drop <src/dst/both> inactive	Disables a static MAC address port filtering rule.	
mirror-port		Enables port mirroring.	
	<port-num>	Enables port mirroring on a specified port.	
lacp		Enables Link Aggregation Control Protocol (LACP).	
	system-priority	<1-65535>	Sets the priority of an active port using LACP.
trunk	interface <port-list> timeout <lacp-timeout>	Defines the port number and LACP timeout period.	
	<T1 T2 T3 T4 T5 T6>	Activates a trunk group.	
	<T1 T2 T3 T4 T5 T6> lacp	Enables LACP for a trunk group.	
	<T1 T2 T3 T4 T5 T6> interface <port-list>	Adds a port(s) to the specified trunk group.	
cluster	<vlan-id>	Sets the cluster management VLAN ID.	
	name <cluster name>	Configures a name to identify the cluster manager	
	member <mac-address> password <password-str>	Sets the cluster member switch's hardware MAC address and password.	
	rcommand <mac-address>	Logs into a cluster member switch.	

Table 28-3 Command Summary: Configure Mode

COMMAND		DESCRIPTION
classifier	<pre> <name> <[packet-format <802.3untag 802.3tag EtherIIuntag EtherI Itag>] [priority <0-7>] [vlan <vlan-id>] [ethernet-type <ether-num ip ipx arp rarp appletalk decnet sna netbios dlc>] [source-mac <src- mac-addr>] [source-port <port- num>] [destination- mac <dest-mac- addr>] [dscp <0-63>] [ip-protocol <protocol- num tcp udp icmp eg p ospf rsvp igmp igp pim ipsec>] [establish-only]] [source-ip <src-ip- addr> [mask-bits <mask-bits>]] [source-socket <socket-num>] [destination-ip <dest-ip-addr> [mask-bits <mask- bits>]] [destination-socket <socket-num>] [inactive]> </pre>	Configures a classifier. A classifier groups traffic into data flows according to specific criteria such as the source address, destination address, source port number, destination port number or incoming port number.

Table 28-3 Command Summary: Configure Mode

COMMAND		DESCRIPTION
policy	<pre> <name> classifier <classifier-list> < [vlan<vlan-id>] [egress-port <port- num>] [priority <0-7>] [dscp <0-63>] [tos <0-7>] [bandwidth <bandwidth>] [outgoing-packet- format <tagged untagged>] [out-of-profile- dscp <0-63>] [forward-action <drop forward>] [queue-action <prio-set prio- queue prio-replace- tos>] [diffserv-action <diff-set-tos diff- replace- priority diff-set- dscp>] [outgoing-mirror] [outgoing-eport] [outgoing-non- unicast-eport] [outgoing-set-vlan] [metering] [out-of-profile- action <[change- dscp][drop][forward]>] [inactive]> </pre>	Configures a policy. A classifier distinguishes traffic into flows based on the configured criteria. A policy rule ensures that a traffic flow gets the requested treatment in the network.
radius-server	<pre> host <ip> [acct- port <socket- number>] [key <key- string>] </pre>	Sets the IP address of the external RADIUS server, UDP port and shared key.
port-access- authenticator		Enables 802.1x authentication on the switch.
	<port-list>	Enables 802.1x authentication on the specified port(s).

Table 28-3 Command Summary: Configure Mode

COMMAND		DESCRIPTION
	<port-list> reauthenticate	Sets a subscriber to periodically re-enter his or her username and password to stay connected to a specified port.
	<port-list> reauth- period <reauth- period>	Specifies how often a client has to re-enter the username and password to stay connected to the specified port(s).
port-security	<port-list>	Enables the port security feature on the specified port(s).
	<port-list> learn inactive	Disables MAC address learning on the specified port(s).
	<port-list> address-limit <number>	Limits the number of (dynamic) MAC addresses that may be learned on a port.
vlanlq	gvrp	Allows VLAN groups beyond the local switch.
	port-isolation	Enables port isolation.
garp	join <100-65535> leave <msec> leaveall <msec>	Configures GARP time settings.
spanning-tree		Enables STP on the switch.
	<port-list>	Enables STP on a specified port.
	<port-list> priority <0-255>	Sets the priority for a specified port.
	<port-list> path- cost <1-65535>	Sets the STP path cost for a specified port.
	priority <0-61440>	Sets the bridge priority of the switch.
	hello-time <1-10> maximum-age <6-40> forward-delay <4- 30>	Sets Hello Time, Maximum Age and Forward Delay.
hostname	<name_string>	Sets the switch's name for identification purposes.
time	<Hour:Min:Sec>	Sets the time in hour, minute and second format.
	date <month/day/year>	Sets the date in year, month and day format.
	timezone <- 1200 ... 1200>	Selects the time difference between UTC (formerly known as GMT) and your time zone.

Table 28-3 Command Summary: Configure Mode

COMMAND		DESCRIPTION
timesync	<daytime time ntp>	Sets the time server protocol.
	server <ip>	Sets the IP address of your time server.
loginPrecedence	<LocalOnly LocalRADIUS RADIUSOnly>	Select which database the switch should use (first) to authenticate a user.
igmp-snooping		Enables IGMP snooping.
bcp-transparency		Enables Bridge Control Protocol Transparency.
queue	level <0-7> priority <0-7>	Sets the priority level-to-physical queue mapping.
storm-control		Enables broadcast storm control on the switch.
bandwidth-control		Enables bandwidth control.
mac-aging-time	<10-3000>	Sets learned MAC aging time.
snmp-server	[contact <system contact>] [location <system location>]	Sets the geographic location and the name of the person in charge of this switch.
	get-community <property>	Sets the get community.
	set-community <property>	Sets the set community.
	trap-community <property>	Sets the trap community.
	trap-destination <ip>	Sets the IP addresses of up to four stations to send your SNMP traps to.
logins	username <name> password <pwd>	Configures up to four read-only login accounts.
service-control	icmp	Allows ICMP access to the switch such as pinging and tracerouting.
	snmp	Allows SNMP management.
	http <socket-number> <timeout>	Allows HTTP access on the specified service port and defines the timeout period.
	telnet <socket-number>	Allows Telnet access on the specified service port.
	ftp <socket-number>	Allows FTP access on the specified service port.

Table 28-3 Command Summary: Configure Mode

COMMAND		DESCRIPTION
	ssh <socket-number>	Allows SSH access on the specified service port.
	https <socket-number>	Allows HTTPS access on the specified service port.
remote-management	<index> start-addr <ip> end-addr <ip> service <telnet ftp http icmp snmp>	Specifies a group of trusted computer(s) from which an administrator may use a service to manage the switch.
admin-password	<pw-string> <confirm-string>	Changes the administrator password.
default-management	<in-band out-of-band>	Specifies through which traffic flow the switch is to send packets.
ssh	known-hosts <host-ip> <1024 ssh-rsa ssh-dsa> <key>	Adds a remote host to which the switch can access using SSH service.
https	cert-regeneration <rsa dsa>	Re-generates a certificate.
	timeout <0-65535>	Sets the HTTPS timeout period.
multi-login		Enables multi-login.
dhcp-relay		Enables DHCP relay.
	helper-address <svr_ip> [svr2_ip] [svr3_ip]	Sets the IP addresses of up to 3 DHCP servers.
	option	Allows the switch to add DHCP relay agent information.
	information	Allows the switch to add system name to agent information.

28.9.4 config-vlan Commands

The following table lists the config-vlan commands in configuration mode.

Table 28-4 Command Summary: config-vlan Commands

COMMAND		DESCRIPTION
vlan <1-4094>		Creates a new VLAN group.
	name <name-str>	Specifies a name for identification purposes.
	normal <port-list>	Specifies the port(s) to dynamically join this VLAN group using GVRP

Table 28-4 Command Summary: config-vlan Commands

COMMAND		DESCRIPTION	
	fixed <port-list>	Specifies the port(s) to be a permanent member of this VLAN group.	
	forbidden <port-list>	Specifies the port(s) you want to prohibit from joining this VLAN group.	
	untagged <port-list>	Specifies the port(s) you don't want to tag all outgoing frames transmitted with this VLAN Group ID.	
	inactive	Disables the specified VLAN.	
	help	Displays a list of available VLAN commands.	
	no	fixed <port-list>	Sets fixed port(s) to normal port(s).
		forbidden <port-list>	Sets forbidden port(s) to normal port(s).
		untagged <port-list>	Specifies the port(s) you want to tag all outgoing frames transmitted with this VLAN Group ID.
		inactive	Enables the specified VLAN.
		ip address inband-default dhcp-bootp	Sets the default in-band interface to use a static IP address in this VLAN. The switch will use the default IP address of 0.0.0.0 if you do not configure a static IP address.
		ip address default-gateway	Deletes the default gateway from this VLAN.
		ip address <ip-address> <mask>	Deletes the IP address and subnet mask from this VLAN.
	exit		Leaves config-vlan mode.
	ip address	inband-default dhcp-bootp release	Releases the dynamic in-band IP address.
		inband-default dhcp-bootp renew	Updates the dynamic in-band IP address.
		inband-default dhcp-bootp	Sets the dynamic in-band IP address.
		inband-default <ip-address> <mask>	Sets a static in-band IP address and subnet mask.
		default-gateway <ip-address>	Sets a default gateway IP address for this VLAN.

Table 28-4 Command Summary: config-vlan Commands

COMMAND			DESCRIPTION
		<ip-address> <mask> manageable	Allows the switch to be managed using this specified IP address.
		<ip-address> <mask>	Sets the IP address and subnet mask of the switch in the specified VLAN for packet loopback test.

28.9.5 interface Commands

The following commands are listed in configuration mode as “interface” switch commands; all are preceded with the command `interface`.

Table 28-5 Command Summary: Interface

COMMAND			DESCRIPTION
<code>interface</code> <port-list>			Enables a port or a list of ports for configuration.
	<code>bandwidth-limit</code>		Enables bandwidth limit on the switch.
	<code>bandwidth-limit egress</code>	<Mbps>	Sets the maximum bandwidth allowed for outgoing traffic on the switch.
	<code>bandwidth-limit ingress</code>	<Mbps>	Sets the maximum bandwidth allowed for incoming traffic on the switch.
	<code>broadcast-limit</code>		Enables broadcast storm control limit on the switch.
	<code>broadcast-limit</code>	<pkt/s>	Sets how many broadcast packets the interface receives per second.
	<code>multicast-limit</code>		Enables the interface multicast limit.
	<code>multicast-limit</code>	<pkt/s>	Sets how many multicast packets the interface receives per second.
	<code>dlf-limit</code>		Enables the Destination Lookup Failure (DLF) limit.
	<code>dlf-limit</code>	<pkt/s>	Sets the interface DLF limit in packets per second (pps).
	<code>spq</code>		Sets the interface to use Strict Priority Queuing.
	<code>wrr</code>		Sets the interface to use Weighted Round Robin queuing (WRR).

Table 28-5 Command Summary: Interface

COMMAND		DESCRIPTION
	<wt1> <wt2> ... <wt8>	Sets the interface to use WRR queuing. A weight value of one to eight is given to each variable from wt 1 to wt 8.
egress set	<port-list>	Sets the outgoing traffic port list for a port-based VLAN.
pvid	<1-4094>	The default PVID is VLAN 1 for all ports. Sets a PVID in the range 1 to 4094 for the specified interface.
ingress-check		Enables the device to discard incoming frames for VLANs that are not included in a port member set.
gvrp		Enables this function to permit VLAN groups beyond the local switch.
frame-type	<all tagged>	Choose to accept both tagged and untagged incoming frames or just tagged incoming frames on a port.
name	<port-name-string>	Sets a name for your interface. Enter a descriptive name (up to nine printable ASCII characters).
vlan-trunking		Enables VLAN Trunking on ports connected to other switches or routers (but not ports directly connected to end users) to allow frames belonging to unknown VLAN groups to pass through the switch.
flow-control		Enables interface flow control. Flow control regulates transmissions to match the bandwidth of the receiving port.
qos priority	<0 .. 7>	Sets the quality of service priority for an interface.
mirror		Enables port mirroring in the interface.
mirror dir	<ingress egress both>	Enables port mirroring for incoming, outgoing or both incoming and outgoing traffic. Port mirroring copies traffic from one or all ports to another or all ports for external analysis.

Table 28-5 Command Summary: Interface

COMMAND		DESCRIPTION
speed-duplex	<auto 10-half 10-full 100-half 100-full 1000-full>	Sets the duplex mode (half, full) and speed (10/100/1000 Mbps) of the connection on the interface. Selecting auto (auto-negotiation) makes one port able to negotiate with a peer automatically to obtain the connection speed and duplex mode that both ends support.
bpdu-control	<peer tunnel discard network>	Sets how Bridge Protocol Data Units (BPDUs) are used in STP port states.
no ingress-check		Incoming traffic is not checked for VLAN tags.
no gvrp		Disables GVRP on the switch.
no flow-control		Disables flow control on the switch.
no vlan-trunking		Disables VLAN trunking on the switch.
no mirror		Disables port mirroring on the switch.
no bandwidth-limit		Disables bandwidth limit on the switch.
no broadcast-limit		Disables broadcast storm control limit on the switch.
no multicast-limit		Disables multicast limit on the switch.
no dlf-limit		Disables destination lookup failure (DLF) on the switch.
no inactive		Enables the specified interface on the switch.
inactive	*	Disables the specified interface on the switch
help		Displays a description of the interface commands.
exit		Exits from the interface configuration command set.
test		Performs an interface loopback test.

Chapter 29

Command Examples

This chapter describes some commands in more detail.

29.1 Overview

These are commands that you may use frequently in maintaining your switch.

29.2 show Commands

These are the commonly used `show` commands.

29.2.1 show system-information

Syntax:

```
show system-information
```

This command shows the general system information (such as the firmware version and system up time).

An example is shown next.

```
System Name      : GS-3012
System Contact   :
System Location  :
Ethernet Address: 00:13:49:11:22:34
ZyNOS F/W Version: V3.60(HO.0)b1 | 01/21/2005
RomRasSize      : 2891036
System up Time   :    0:56:32 (52d1d ticks)
Bootbase Version: V3.00 | 01/14/2005
ZyNOS CODE       : RAS Jan 21 2005 21:40:05
Product Model   : GS-3012
GS-3012>
```

Figure 29-1 show system-information Command Example

29.2.2 show hardware-monitor

Syntax:

```
show hardware-monitor [c|f]
```

This command displays the current hardware status (such as temperature and voltage levels).

```

GS-3012> show hardware-monitor c
Temperature Unit : (c)
Temperature      Current  MAX    MIN    Threshold  Status
MAC              32.0   32.0   26.0   65.0       Normal
CPU              30.0   30.0   25.0   65.0       Normal
PHY              31.0   31.0   26.0   65.0       Normal

FAN Speed(RPM)  Current  MAX    MIN    Threshold  Status
FAN1             5716    5810   5536   4500       Normal
FAN2             5810    5859   5536   4500       Normal
FAN3             5908    5958   5670   4500       Normal

Voltage(V)      Current  MAX    MIN    Threshold  Status
2.5              2.608   2.608  2.608  +/-5%      Normal
1.25             1.280   1.296  1.280  +/-10%     Normal
3.3              3.392   3.392  3.392  +/-5%      Normal
12               12.160  12.160 12.160 +/-10%     Normal
5                5.053   5.053  5.053  +/-5%      Normal
1.3              1.328   1.328  1.328  +/-5%      Normal
1.25             1.296   1.296  1.280  +/-5%      Normal
GS-3012>

```

Figure 29-2 show hardware-monitor Command Example

29.2.3 show ip

Syntax:

```
show ip
```

This command displays the IP related information (such as IP address and subnet mask) on all switch interfaces.

```

GS-3012> show ip
Out-of-band Management IP Address = 192.168.0.1

VPS00, Device Type: Ethernet, Idle/Timeout: disable
  Number of Interface : 1
    enif0 : IP[192.168.0.1], Netmask[255.255.255.0], VID[0]

VPS01, Device Type: Switch, Idle/Timeout: disable, [MGMT VPS], [CNTL VPS]
  Number of Interface : 2
    cmif0 : IP[127.0.0.1], Netmask[255.0.0.0], VID[1]
    swif0 : IP[192.168.1.1], Netmask[255.255.255.0], VID[1]

GS-3012>

```

Figure 29-3 show ip Command Example

29.2.4 show logging

This command is not available in User mode.

Syntax:

```
show logging
```

This command displays the system logs. The following figure shows an example.

```

GS-3012# show logging
50 Thu Jan 1 00:01:54 1970 PP05 -WARN SNMP TRAP 3: link up
51 Thu Jan 1 00:03:04 1970 PINI -WARN SNMP TRAP 0: cold start
52 Thu Jan 1 00:03:04 1970 PP0e -WARN SNMP TRAP 24: Event On Trap
53 Thu Jan 1 00:03:04 1970 PINI INFO main: init completed
54 Thu Jan 1 00:00:02 1970 PINI -WARN SNMP TRAP 0: cold start
55 Thu Jan 1 00:00:02 1970 PP0e -WARN SNMP TRAP 24: Event On Trap
56 Thu Jan 1 00:00:02 1970 PINI INFO main: init completed
57 Thu Jan 1 00:00:02 1970 PINI -WARN SNMP TRAP 0: cold start
58 Thu Jan 1 00:00:02 1970 PP0e -WARN SNMP TRAP 24: Event On Trap
59 Thu Jan 1 00:00:02 1970 PINI INFO main: init completed
Clear Error Log (y/n):

```

Figure 29-4 show logging Command Example

If you clear a log (by entering `y` at the “Clear Error Log (y/n):” prompt), you cannot view it again.

29.2.5 show interface

Syntax:

```
show interface [port-number]
```

This command displays statistics of a port. The following example shows that port 10 is up and the related information.

```

GS-3012# show interface 10
Port Info      Port NO.      :10
               Link           :100M/F
               Status        :FORWARDING
               LACP          :Disabled
               TxPkts        :69
               RxPkts        :4
               Errors        :0
               Tx Kbs/s      :1.684
               Rx Kbs/s      :1.684
               Up Time       : 0:02:12
TX Packet      Tx Packets    :69
               Multicast     :0
               Broadcast     :0
               Pause         :0
               Tagged        :0
RX Packet      Tx Packets    :4
               Multicast     :0
               Broadcast     :4
               Pause         :0
               Control       :0
TX Collison    Single        :0
               Multiple      :0
               Excessive     :0
               Late          :0
Error Packet   RX CRC       :0
               Length       :0
               Runt         :0
Distribution   64          :4
               65 to 127    :74
               128 to 255   :18
               256 to 511   :0
               512 to 1023  :0
               1024 to 1518 :44
               Giant        :0
GS-3012#

```

Figure 29-5 show interface Command Example

29.2.6 show mac address-table

Syntax:

```
show mac address-table <all <sort>|static>
```

Where

<sort> = Specifies the sorting criteria (MAC, VID or port).

This command displays the MAC address(es) stored in the switch. The following example shows a static MAC address table.

```
GS-3012# show mac address-table static
Vid      Mac Port      Status
1 01:a0:c5:aa:aa:aa 1      Permanent
GS-3012#
```

Figure 29-6 show mac address-table Command Example

29.3 ping

Syntax:

```
ping <ip> < [in-band|out-of-band|vlan <vlan-id> ] [ size <0-8024> ] [ -t ]>
```

where

<ip>	=	The IP address of an Ethernet device.
[in-band out-of-band vlan <vlan-id>]	=	Specifies the network interface or the VLAN ID to which the Ethernet device belongs. out-of-band refers the management port while in-band means the other ports on the switch.
[size <0-8024>]	=	Specifies the packet size to send.
[-t]	=	Sends Ping packets to the Ethernet device indefinitely. Click [CTRL]+C to terminate the Ping process.

This command sends Ping packets to an Ethernet device. The following example sends Ping requests to and displays the replies from an Ethernet device with an IP address of 192.168.1.100.

```
GS-3012# ping 192.168.1.100
sent rcvd rate    rtt    avg    mdev    max    min  reply from
1    1    100      0      0      0      0      0  192.168.1.100
2    2    100      0      0      0      0      0  192.168.1.100
3    3    100      0      0      0      0      0  192.168.1.100
GS-3012#
```

Figure 29-7 ping Command Example

29.4 traceroute

Syntax:

```
tracertoute <ip> [in-band|out-of-band|vlan <vlan-id>][ttl <1-255>] [wait
<1-60>] [queries <1-10>]
```

where

<ip>	=	The IP address of an Ethernet device.
[in-band out-of-band vlan <vlan-id>]	=	Specifies the network interface or the VLAN ID to which the Ethernet device belongs.
[ttl <1-255>]	=	Specifies the Time To Live (TTL) period.
[wait <1-60>]	=	Specifies the time period to wait.
[quesries <1-10>]	=	Specifies how many tries the switch performs the tracertoute function.

This command displays information about the route to an Ethernet device. The following example displays route information to an Ethernet device with an IP address of 192.168.1.100.

```
GS-3012> tracertoute 192.168.1.100
tracertoute to 192.168.1.100, 30 hops max, 40 byte packet
 1:192.168.1.100 (10 ms) (10 ms) (0 ms)
tracertoute done:
```

Figure 29-8 tracertoute Command Example

29.5 Enabling RSTP

To enable RSTP on a port. Enter “spanning-tree” followed by the port number and press [ENTER]. The following example enables RSTP on port 10.

```
GS-3012 (config)# spanning-tree 10
GS-3012#
```

Figure 29-9 Enable RSTP Command Example

29.6 Configuration File Maintenance

This section shows you how to backup or restore the configuration file on the switch using TFTP.

29.6.1 Backing up Configuration

Syntax:

```
copy running-config tftp <ip> <remote-file>
```

where

<ip>	=	The IP address of a TFTP server on which you want to store the backup configuration file.
------	---	---

`<remote-file>` = Specifies the name of the configuration file.

This command backs up the current configuration file on a TFTP server. The following example backs up the current configuration to a file (`test.cfg`) on the TFTP server (`172.23.19.96`).

```
GS-3012# copy running-config tftp 172.23.19.96 test.cfg
Backuping
. (599)Bytes Done!
GS-3012#
```

Figure 29-10 CLI: Backup Configuration Example

29.6.2 Restoring Configuration

Syntax:

```
copy tftp config <index> <ip> <remote-file>
```

where

`<index>` = Specifies to restore which configuration file (1 or 2) on the switch.
`<ip>` = The IP address of a TFTP server from which you want to get the backup configuration file.
`<remote-file>` = Specified the name of the configuration file.

This command restores a configuration file on the switch. The following example uploads the configuration file (`test.cfg`) from the TFTP server (`172.23.19.96`) to the switch.

```
GS-3012# copy tftp config 1 172.23.19.96 test.cfg
Restoring
. (599)Bytes Done!
GS-3012#
```

Figure 29-11 CLI: Restore Configuration Example

29.6.3 Using a Different Configuration File

You can store up to two configuration files on the switch. Only one configuration file is used at a time. By default the switch uses the first configuration file (with an index number of 1). You can set the switch to use a different configuration file. There are two ways in which you can set the switch to use a different configuration file: restart the switch (cold reboot) and restart the system (warm reboot).

Use the `boot config` command to restart the switch and use a different configuration file (if specified). The following example reboots the switch to use the second configuration file.

```
GS-3012# boot config 2
```

Figure 29-12 CLI: boot config Command Example

Use the `reload config` command to restart the system and use a different configuration file (if specified). The following example restarts the system to use the second configuration file.

```
GS-3012# reload config 2
```

Figure 29-13 CLI: reload config Command Example

When you use the `write memory` command without specifying a configuration file index number, the switch saves the changes to the configuration file the switch is currently using.

29.6.4 Resetting to the Factory Default

Follow the steps below to reset the switch back to the factory defaults.

1. Enter `erase running config` to reset the current running configuration.
2. Enter `write memory` to save the changes to the current configuration file. If you want to reset the second configuration file, use the `write memory` command again with the specified index number.

The following example resets both configuration files to the factory default settings.

```
GS-3012# erase running-config
GS-3012# write memory
GS-3012# write memory 2
```

Figure 29-14 CLI: Reset to the Factory Default Example

29.7 Example no Commands

These are the commonly used command examples that belong to the “no” group of commands.

29.7.1 no mirror-port

Syntax:

```
no mirror-port
```

Disables port mirroring on the switch.

An example is shown next.

```
GS-3012(config)# no mirror-port
```

Figure 29-15 no mirror-port Command Example

29.7.2 no https timeout

Syntax:

```
no https timeout
```

Resets the https session timeout to default.

An example is shown next. The session timeout is reset to 300 seconds.

```
GS-3012(config)# no https timeout
Cache timeout 300
```

Figure 29-16 no https timeout Command Example

29.7.3 no trunk

Syntax:

```
no trunk <T1|T2|T3|T4|T5|T6>
no trunk <T1|T2|T3|T4|T5|T6> lacp
no trunk <T1|T2|T3|T4|T5|T6> interface <port-list>
```

where

```
<T1|T2|T3|T4|T5|T6> Disables the trunk group.
5|T6>
<T1|T2|T3|T4|T5|T6> lacp Disables LACP in the trunk group.
5|T6>
<T1|T2|T3|T4|T5|T6> interface <port-list> Removes ports from the trunk group.
5|T6>
interface
<port-list>
```

An example is shown next.

Disable trunk one (T1).

Disable LACP on trunk three (T3).

Remove ports one, three, four and five from trunk five (T5).

```
GS-3012(config)# no trunk T1
GS-3012(config)# no trunk T3 lacp
GS-3012(config)# no trunk T5 interface 1,3-5
```

Figure 29-17 no trunk Command Example

29.7.4 no port-access-authenticator

Syntax:

```
no port-access-authenticator
no port-access-authenticator <port-list> reauthenticate
no port-access-authenticator <port-list>
```

where

	Disables port authentication on the switch.
<port-list> reauthenticate	Disables the re-authentication mechanism on the listed port(s).
<port-list>	Disables authentication on the listed ports.

An example is shown next.

Disable authentication on the switch.

Disable re-authentication on ports one, three, four and five.

Disable authentication on ports one, six and seven.

```
GS-3012(config)# no port-access-authenticator
GS-3012(config)# no port-access-authenticator 1,3-5 reauthenticate
GS-3012(config)# no port-access-authenticator 1,6-7
```

Figure 29-18 no port-access-authenticator Command Example

29.7.5 no ssh

Syntax:

```
no ssh key <rsa|rsa|dsa>
no ssh known-hosts <host-ip> <cr>
no ssh known-hosts <host-ip> [1024|ssh-rsa|ssh-dsa]
```

where

key <rsa rsa dsa>	Disables the secure shell server encryption key. Your switch supports SSH versions 1 and 2 using RSA and DSA authentication.
known-hosts <host-ip>	Remove specific remote hosts from the list of all known hosts.

known-hosts	Remove remote known hosts with a specified public key (1024-bit RSA1, RSA or DSA).
<host-ip>	
[1024 ssh- rsa ssh-dsa]	

An example is shown next.

Disable the secure shell RSA1 encryption key.

Remove the remote host with IP address 172.165.1.8 from the list of known hosts.

Remove the remote host with IP address 172.165.1.9 and with an SSH-RSA encryption key from the list of known hosts.

```
GS-3012(config)# no ssh key rsa1
GS-3012(config)# no ssh known-hosts 172.165.1.8
GS-3012(config)# no ssh known-hosts 172.165.1.9 ssh-rsa
```

Figure 29-19 no ssh Command Example

29.8 interface Commands

These are some commonly used commands that belong to the interface group of commands.

29.8.1 interface

Syntax:

```
interface
```

Each interface refers to an Ethernet port on the switch. Commands configured after the interface command correspond to those ports. Type multiple ports or port ranges separated by a comma. Ranges of port numbers are typed separated by a dash.

An example is shown next.

Enter the configuration command set.

Enable ports one, three, four and five for configuration.

Begin configuring for those ports.

```
GS-3012# config
GS-3012(config)# interface 1,3-5
GS-3012(config-interface)#
```

Figure 29-20 interface Command Example

29.8.2 bpdu-control

Syntax:

```
bpdu-control <peer|tunnel|discard|network>
```

where

<pre><peer tunnel discard network>=</pre>	<p>Type <code>peer</code> to process any BPDUs received on these ports.</p> <p>Type <code>tunnel</code> to forward BPDUs received on these ports.</p> <p>Type <code>discard</code> to drop any BPDUs received on these ports.</p> <p>Type <code>network</code> to process a BPDU with no VLAN tag and forward a tagged BPDU.</p>
---	--

An example is shown next.

Enable ports one, three, four and five for configuration.

Set the BPDU control to tunnel, to forward BPDUs received on ports one, three, four and five.

```
GS-3012(config)# interface 1,3-5
GS-3012(config-interface)# bpdu-control tunnel
GS-3012(config-interface)#
```

Figure 29-21 interface bpdu-control Command Example

29.8.3 broadcast-limit

Syntax:

```
broadcast-limit
broadcast-limit <pkt/s>
```

where

Enables broadcast storm control limit on the switch.

<pkt/s> Sets how many broadcast packets the interface receives per second.

An example is shown next.

Enable port one for configuration.

Enable broadcast control.

Set the number of broadband packets the interface receives per second

```
GS-3012(config)# interface 1
GS-3012(config-interface)# broadcast-limit
GS-3012(config-interface)# broadcast-limit 21
```

Figure 29-22 broadcast-limit Command Example

29.8.4 bandwidth-limit

Syntax:

```
bandwidth-limit
bandwidth-limit egress <Mbps>
bandwidth-limit ingress <Mbps>
```

where

	Enables bandwidth control on the switch.
<Mbps>	Sets the maximum bandwidth allowed for outgoing traffic (egress) or incoming traffic (ingress) on the switch.

An example is shown next.

Enable port one for configuration.

Enable bandwidth control.

Set the outgoing traffic bandwidth limit to 7Mbps.

Set the incoming traffic bandwidth limit to 9Mbps.

```
GS-3012(config)# interface 1
GS-3012(config-interface)# bandwidth-limit
GS-3012(config-interface)# bandwidth-limit egress 7
GS-3012(config-interface)# bandwidth-limit ingress 9
```

Figure 29-23 bandwidth-limit Command Example

29.8.5 mirror

Syntax:

```
mirror
mirror dir <ingress|egress|both>
```

where

	Enables port mirroring on the interface.
<ingress egress both>	Enables port mirroring for incoming, outgoing or both incoming and outgoing traffic.
	Port mirroring copies traffic from one or all ports to another or all ports for external analysis.

An example is shown next.

Enable port mirroring.

Enable the monitor port three.

Enable ports one, four, five and six for configuration.

Enable port mirroring on the interface.

Enable port mirroring for outgoing traffic. Traffic is copied from ports one, four, five and six to port three in order to examine it in more detail without interfering with the traffic flow on the original port(s).

```
GS-3012(config)# mirror-port
GS-3012(config)# mirror-port 3
GS-3012(config)# interface 1,4-6
GS-3012(config-interface)# mirror
GS-3012(config-interface)# mirror dir egress
```

Figure 29-24 mirror Command Example

29.8.6 gvrp

Syntax:

```
gvrp
```

GVRP (GARP VLAN Registration Protocol) is a registration protocol that defines a way for switches to register necessary VLAN members on ports across the network. Enable this function to permit VLANs groups beyond the local switch.

An example is shown next.

Enable the IEEE 802.1Q tagged VLAN command to configure tagged VLAN for the switch.

Enable ports one, three, four and five for configuration.

Enable GVRP on the interface.

```
GS-3012(config)# vlan1q gvrp
GS-3012(config)# interface 1,3-5
GS-3012(config-interface)# gvrp
```

Figure 29-25 gvrp Command Example

29.8.7 ingress-check

Syntax:

```
ingress-check
```

Enables the device to discard incoming frames for VLANs that are not included in a port member set.

An example is shown next.

Enable ports one, three, four and five for configuration.

Enable ingress checking on the interface.

```
GS-3012(config)# interface 1,3-5
GS-3012(config-interface)# ingress-check
```

Figure 29-26 ingress-check Command Example

	frame-type	<all tagged>	Choose to accept both tagged and untagged incoming frames or just tagged incoming frames on a port.
--	------------	--------------	---

29.8.8 frame-type

Syntax:

```
frame-type <all|tagged>
```

where

<all|tagged> Choose to accept both tagged and untagged incoming frames or just tagged incoming frames on a port.

An example is shown next.

Enable ports one, three, four and five for configuration.

Enable ingress checking on the interface.

Enable tagged frame-types on the interface.

```
GS-3012(config)# interface 1,3-5
GS-3012(config-interface)# ingress-check
GS-3012(config-interface)# frame-type tagged
```

Figure 29-27 frame-type Command Example

29.8.9 vlan-trunking

Syntax:

```
vlan-trunking
```

Enable VLAN Trunking on ports connected to other switches or routers (but not ports directly connected to end users) to allow frames belonging to unknown VLAN groups to pass through the switch.

An example is shown next.

Enable ports one, three, four and five for configuration.

Enable VLAN Trunking on the interface.

```
GS-3012(config)# interface 1,3-5
GS-3012(config-interface)# vlan-trunking
```

Figure 29-28 vlan-trunking Command Example

29.8.10 spq

Syntax:

```
spq
```

Sets the interface to use Strict Priority Queuing.

An example is shown next.

Enable ports one, three, four and five for configuration.

Enable VLAN Trunking on the interface.

```
GS-3012(config)# interface 1,3-5
GS-3012(config-interface)# spq
```

Figure 29-29 spq Command Example

29.8.11 wrr

Syntax:

```
wrr
wrr <wt1> <wt2> ... <wt8>
```

where

Enables WRR on the switch.

<wt1> <wt2>
... <wt8> Sets the interface to use Weighted Round Robin queuing. A weight value of one to eight is given to each variable from wt 1 to wt 8.

An example is shown next.

Enable port two and ports six to twelve for configuration.

Enable Weighted Round Robin queuing on the interface.

Set the queue weights from Q0 to Q7.

```
GS-3012# configure
GS-3012(config)# interface 2,6-12
GS-3012(config-interface)# wrr
GS-3012(config-interface)# wrr 8 7 6 5 4 3 2 1
```

Figure 29-30 wrr Command Example

29.8.12 egress set

Syntax:

```
egress set <port-list>
```

where

<port-list> Sets the outgoing traffic port list for a port-based VLAN.

An example is shown next.

Enable port-based VLAN tagging on the switch.

Enable ports one, three, four and five for configuration.

Set the outgoing traffic ports as the CPU (0), seven (7), eight (8) and nine (9).

```
GS-3012(config)# vlan-type port-based
GS-3012(config)# interface 1,3-5
GS-3012(config-interface)# egress set 0,7-9
```

Figure 29-31 egress set Command Example

29.8.13 qos priority

Syntax:

```
qos priority <0 .. 7>
```

where

```
<0 .. 7>      Sets the quality of service priority for an interface(s).
```

An example is shown next.

Enable ports one, three, four and five for configuration.

Set the IEEE 802.1p quality of service priority as four (4).

```
GS-3012(config)# interface 1,3-5
GS-3012(config-interface)# qos priority 4
```

Figure 29-32 qos priority Command Example

29.8.14 name

Syntax:

```
name <port-name-string>
```

where

```
<port-name-   Sets a name for your port interface(s).
string>
```

An example is shown next.

Enable ports one, three, four and five for configuration.

Set a name for the interfaces.

```
GS-3012(config)# interface 1,3-5
GS-3012(config-interface)# name Test
```

Figure 29-33 name Command Example

29.8.15 speed-duplex

Syntax:

```
speed-duplex <auto|10-half|10-full|100-half|100-full|1000-full>
```

where

<auto 10-	Sets the duplex mode (half, full) and speed (10/100/1000 Mbps) of the connection on the interface. Selecting auto (auto-negotiation) makes one port able to negotiate with a peer automatically to obtain the connection speed and duplex mode that both ends support.
half 10-	
full 100-	
half 100-	
full 1000-	
full>	

An example is shown next.

Enable ports one, three, four and five for configuration.

Set the speed to 10 Mbps in half duplex mode.

```
GS-3012(config)# interface 1,3-5
GS-3012(config-interface)# speed-duplex 10-half
```

Figure 29-34 speed-duplex Command Example

Chapter 30

IEEE 802.1Q Tagged VLAN Commands

This chapter describes the IEEE 802.1Q Tagged VLAN and associated commands.

30.1 IEEE 802.1Q Tagged VLAN Overview

See the *VLAN* chapter for more information on VLANs. There are two kinds of tagging:

1. Explicit Tagging

A VLAN identifier is added to the frame header that identifies the source VLAN.

2. Implicit Tagging

The MAC (Media Access Control) number, the port or other information is used to identify the source of a VLAN frame.

The IEEE 802.1Q Tagged VLAN uses both explicit and implicit tagging.

Whether to tag an outgoing frame depends on the setting of the egress port on a per-LAN, per-port basis (recall that a port can belong to multiple VLANs). If the tagging on the egress port is enabled for the VID of a frame, then the frame is transmitted as a tagged frame; otherwise, it is transmitted as an untagged frame.

30.2 VLAN Databases

A VLAN database stores and organizes VLAN registration information useful for switching frames to and from a switch. A VLAN database consists of a static entries (Static VLAN or SVLAN table) and dynamic entries (Dynamic VLAN or DVLAN table).

30.2.1 Static Entries (SVLAN Table)

Static entry registration information is added, modified and removed by administrators only.

30.2.2 Dynamic Entries (DVLAN Table)

Dynamic entries are learned by the switch and cannot be created or updated by administrators. The switch learns this information by observing what port, source address and VLAN ID (or VID) is associated with a frame. Entries are added and deleted using GARP VLAN Registration Protocol (GVRP), where GARP is the Generic Attribute Registration Protocol.

30.3 Configuring Tagged VLAN

The following procedure shows you how to configure tagged VLAN.

3. Use the IEEE 802.1Q tagged VLAN commands to configure tagged VLAN for the switch.
 - Use the `vlan <vlan-id>` command to configure or create a VLAN on the switch. The switch automatically enters the `config-vlan` mode.
 - Use the `exit` command when you are finished configuring the VLAN.
 - Use the `interface <port-list>` command to enter the `config-interface` mode to set the VLAN settings on a port, then use the `pvid <vlan-id>` command to set the VLAN ID you created for the port-list to that specific port in the PVID table.
 - Use the `inactive` command to deactivate the VLAN(s).

Example:

```
GS-3012 (config)# vlan 2000
GS-3012 (config-vlan)# name up1
GS-3012 (config-vlan)# fixed 10-12
GS-3012 (config-vlan)# no untagged 10-12
GS-3012 (config-vlan)# exit
GS-3012 (config)# interface 10-12
GS-3012 (config-interface)# pvid 2000
GS-3012 (config-interface)# exit
```

Figure 30-1 Tagged VLAN Configuration and Activation Example

4. Configure your management VLAN.
 - Use the `vlan <vlan-id>` command to create a VLAN (VID 3 in this example) for managing the switch, and the switch will activate the new management VLAN.
 - Use the `inactive` command to disable the new management VLAN.

Example:

```
GS-3012 (config)# vlan 3
GS-3012 (config-vlan)# inactive
```

Figure 30-2 CPU VLAN Configuration and Activation Example

30.4 Global VLAN1Q Tagged VLAN Configuration Commands

This section shows you how to configure and monitor the IEEE 802.1Q Tagged VLAN.

30.4.1 GARP Status

Syntax:

```
show garp
```

This command shows the switch's GARP timer settings, including the join, leave and leave all timers.

An example is shown next.

```
GS-3012 # show garp
GARP Timer
-----
Join Timer = 200
Leave Timer = 600
Leave All Timer = 10000
GS-3012#
```

Figure 30-3 GARP STATUS Command Example

30.4.2 GARP Timer

Syntax:

```
garp join <msec> leave <msec> leaveall <msec>
```

where

join <msec> =	This sets the duration of the Join Period timer for GVRP in milliseconds. Each port has a Join Period timer. The allowed Join Time range is between 100 and 32767 milliseconds; the default is 200 milliseconds.
leave <msec> =	This sets the duration of the Leave Period timer for GVRP in milliseconds. Each port has a single Leave Period timer. Leave Time must be two times larger than Join Timer; the default is 600 milliseconds.
leaveall <msec> =	This sets the duration of the Leave All Period timer for GVRP in milliseconds. Each port has a single Leave All Period timer. Leave All Timer must be larger than Leave Timer; the default is 10000 milliseconds.

This command sets the switch's GARP timer settings, including the join, leave and leave all timers.

Switches join VLANs by making a declaration. A declaration is made by issuing a Join message using GARP. Declarations are withdrawn by issuing a Leave message. A Leave All message terminates all registrations. GARP timers set declaration timeout values.

The following example sets the Join Timer to 300 milliseconds, the Leave Timer to 800 milliseconds and the Leave All Timer to 11000 milliseconds.

```
GS-3012 (config)# garp join 300 leave 800 leaveall 11000
```

30.4.3 GVRP Timer

Syntax:

```
show vlan1q gvrp
```

This command shows the switch's GVRP settings.

An example is shown next.

```
GS-3012 # show vlan1q gvrp
GVRP Support
-----
gvrpEnable = YES
GVRP Support
```

Figure 30-4 garp status Command Example

30.4.4 Enable GVRP

Syntax:

```
vlan1q gvrp
```

This command turns on GVRP in order to propagate VLAN information beyond the switch.

30.4.5 Disable GVRP

Syntax:

```
no vlan1q gvrp
```

This command turns off GVRP so that the switch does not propagate VLAN information to other switches.

30.5 Port VLAN Commands

You must configure the switch port VLAN settings in config-interface mode.

30.5.1 Set Port VID

Syntax:

```
pvid <VID>
```

where

<VID> = Specifies the VLAN number between 1 and 4094

This command sets the default VLAN ID on the port(s).

The following example sets the default VID to 200 on ports 1 to 5.

```
GS-3012 (config)# interface port-channel 1-5
GS-3012 (config-interface)# pvid 200
```

Figure 30-5 vlan1q port default vid Command Example

30.5.2 Set Acceptable Frame Type

Syntax:

```
frame-type <all|tagged>
```

where

<code><all tagged></code>	Specifies all Ethernet frames (tagged and untagged) or only tagged Ethernet frames.
<code>=</code>	

This command sets the specified port to accept all Ethernet frames or only those with an IEEE 802.1Q VLAN tag.

The following example sets ports 1 to 5 to accept only tagged frames.

```
GS-3012 (config)# interface port-channel 1-5
GS-3012 (config-interface)# frame-type tagged
```

Figure 30-6 frame type Command Example

30.5.3 Enable or Disable Port GVRP

Use the `gvrp` command to enable GVRP on the port(s). Use the `no gvrp` command to disable GVRP.

The following example turns off GVRP for ports 1 to 5.

```
GS-3012 (config)# interface 1-5
GS-3012 (config-interface)# no gvrp
```

Figure 30-7 no gvrp Command Example

30.5.4 Modify Static VLAN

Use the following commands in the `config-vlan` mode to configure the static VLAN table.

Syntax:

```
vlan <vlan-id>
fixed <port-list>
forbidden <port-list>
name <name-str>
normal <port-list>
untagged <port-list>
no fixed <port-list>
no forbidden <port-list>
no untagged <port-list>
```

where

<vlan-id> = The VLAN ID [1 – 4094].
<name-str> = A name to identify the SVLAN entry.
<port-list> = This is the switch port list.

- Enter `fixed` to register the <port-list> to the static VLAN table with <vlan-id>.
- Enter `normal` to confirm registration of the <port-list> to the static VLAN table with <vlan-id>.
- Enter `forbidden` to block a <port-list> from joining the static VLAN table with <vlan-id>.
- Enter `no fixed` or `no forbidden` to change <port-list> to normal status.
- Enter `untagged` to send outgoing frames without a tag.
- Enter `no untagged` to tag outgoing frames.

Modify a Static VLAN Table Example

The following example configures ports 1 to 5 as fixed and untagged ports in VLAN 2000.

```
GS-3012 (config)# vlan 2000
GS-3012 (config-vlan)# fixed 1-5
GS-3012 (config-vlan)# untagged 1-5
```

Figure 30-8 Modifying Static VLAN Example

Forwarding Process Example

Tagged Frames

1. First the switch checks the VLAN ID (VID) of tagged frames or assigns temporary VIDs to untagged frames.
2. The switch then checks the VID in a frame's tag against the SVLAN table.
3. The switch notes what the SVLAN table says (that is, the SVLAN tells the switch whether or not to forward a frame and if the forwarded frames should have tags).
4. Then the switch applies the port filter to finish the forwarding decision. This means that frames may be dropped even if the SVLAN says to forward them. Frames might also be dropped if they are sent to a CPE (customer premises equipment) DSL device that does not accept tagged frames.

Untagged Frames

1. An untagged frame comes in from the LAN.
2. The switch checks the PVID table and assigns a temporary VID of 1.
3. The switch ignores the port from which the frame came, because the switch does not send a frame to the port from which it came. The switch also does not forward frames to “forbidden” ports.
4. If after looking at the SVLAN, the switch does not have any ports to which it will send the frame, it won't check the port filter.

30.5.5 Delete VLAN ID

Syntax:

```
no vlan <vlan-id>
```

where

```
<vlan-id>    The VLAN ID [1 – 4094].  
=
```

This command deletes the specified VLAN ID entry from the static VLAN table. The following example deletes entry 2 in the static VLAN table.

```
GS-3012 (config)# no vlan 2
```

Figure 30-9 no vlan Command Example

30.6 Enable VLAN

Syntax:

```
vlan <vlan-id>
```

This command enables the specified VLAN ID in the SVLAN (Static VLAN) table.

30.7 Disable VLAN

Syntax:

```
vlan <vlan-id>  
inactive
```

This command disables the specified VLAN ID in the SVLAN (Static VLAN) table.

30.8 Show VLAN Setting

Syntax:

```
show vlan
```

This command shows the IEEE 802.1Q Tagged SVLAN (Static VLAN) table.

An example is shown next.

For the AdCtl section of the last column, “-” is a port set to normal, “x” is a forbidden port and “F” is a fixed port.

For the TagCtl section of the last column, “T” is a tagged port, “U” is an untagged port.

```
GS-3012# show vlan
802.1Q VLAN Static Entry:
idx. Name          VID Active AdCtl / TagCtl
-----
0          1      1 active FFFFFFFFFFFFFFFFFFFFFFFFFF
          UUUUUUUUUUUUUUUUUUUUUUUUUUUUUUUUU
1          up1 2000 active -----F-----
          TTTTTTTTTTTTTTTTTTTTTTTTTTTTTTTT
2          up1 2001 active -----F-----
          TTTTTTTTTTTTTTTTTTTTTTTTTTTTUTTT
3          example 3 active -----F-----
          TTTTTTTTTTTTTTTTTTTTTTTTTTTTTTTT
GS-3012#
```

Figure 30-10 show vlan Command Example

Part VIII

Appendix and Index

This part contains an appendix and an Index.

A Product Specifications

These are the GS-3012 product specifications.

Chart 1 General Product Specifications

Standards	IEEE802.3 10BASE-T Ethernet (twisted-pair copper) IEEE802.3u 100BASE-TX Fast Ethernet (twisted-pair copper) ANSI/IEEE802.3 Auto-negotiation IEEE802.3x Flow Control IEEE802.1p Priority Queues IEEE802.1q VLAN IEEE802.1d Spanning Tree IEEE 802.1x Authentication IEEE 802.3 ad Link Aggregation IEEE 802.1w Rapid reconfiguration
Protocol	CSMA/CD
Interface	12 10/100/1000BASE-T Gigabit ports (with four paired Gigabit/mini GBIC ports) Four mini GBIC slots for uplinking One console port One out-of-band RJ-45 management port
Data Transfer Rate	Ethernet: 10Mbps (half duplex), 20Mbps (full duplex) Fast Ethernet: 100Mbps (half duplex), 200Mbps(full duplex) Gigabit: 1000Mbps (half duplex), 2000Mbps (full duplex) Uplink rates depend on the uplink module used (see your module manual).
Network Cables	10BASE-T: 2-pair Unshielded Twisted Pair (UTP) Cat.3, 4, 5 (100 meters) EIA/TIA-586 100-ohm Shielded Twisted Pair (STP) (100 meters) 100BASE-TX, 1000BASE-T: UTP Cat.5 (100 m max.) EIA/TIA-568 100-ohm STP (100 m max.) Uplink cables depend on the uplink module used (see your module manual).
Full/Half Duplex	Full/half duplex for 10/100 Mbps speeds Full duplex 1000 Mbps speed
Media Interface Exchange	All ports are auto-crossover (auto-MDI-X) and auto-negotiating.

Chart 2 Performance and Management Specifications

Back plane	12.8 Gbps
------------	-----------

Chart 2 Performance and Management Specifications

Packet Forwarding Rate	148800 PPS for 100BASE-TX 1488000 PPS for 1000Base-X Uplink packet forwarding rate depends on the uplink module used (see your module manual)
Switching Method	Store-and-forward
MAC Address Table	16 K entries
Data Buffer	1MB (excluding optional modules) Uplink data buffers depend on the uplink module used (see your module manual)
VLAN	IEEE 802.1Q tag-based VLAN, 4094 Max
IEEE 802.1p Priority Queues	Eight CoS queues
Port Link Aggregation	Static port trunking IEEE802.3ad dynamic port trunking
Port Security	Static MAC address filtering MAC address learning limit
Multicasting	Support IGMP snooping
Broadcast Storm	Support broadcast storm control
Port Mirroring	All Gigabit and uplink ports support port mirroring
Management	Web-based management Console Telnet SNMP
Management Security	User ID/Password for console, Telnet and Web-based management authentication Up to four administrators allowed
MIBs	SNMP MIB II (RFC 1213) RFC 1157 SNMP v1 SNMPv2 or SNMPv2c RFC 1643 Ethernet MIBs RFC 1493 Bridge MIBs RFC 1155 SMI RFC 1757 RMON Bridge extension MIBs RFC 2674

Chart 2 Performance and Management Specifications

	Interface MIB RFC 2863 Ping and Trace Route RFC 2925
--	---

Chart 3 Physical and Environmental Specifications

Weight	Main switch: 6Kg
LED	Main switch: BPS, PWR, SYS, ALM, Per Port: LNK/ACT, FDX Per GBIC Slot: LNK, ACT Per Management Port: 10, 100
Dimensions	Main switch: 438(W) x 300(D) x 44.45(H) mm (17.3(W) x 8.9(D) x 2.6(H) inches), 19-inch rack-mount width, 1 U height
Power Supply (AC Unit)	100 - 240VAC 50/60Hz 1.5A max internal universal power supply
Power Supply (DC Unit)	DC input of -48VDC – -60VDC, 1.84A Max.
Power Consumption	Main switch: 35W maximum
Fuse Rating	T2A250VAC Caution: For continued protection against risk of fire, replace only with the same type and fuse rating.
Operating Temperature	0°C ~45°C (32°F to 113°F)
Storage Temperature	-25°C ~70°C
Operational Humidity	10% to 90% (Non-condensing)
Safety	UL 60950-1 CSA 60950-1 EN60950-1 IEC60950 -1 ITU-T K.2 1 (Version 2000)
EMC	FCC Part15 (Class A) CE-EMC (Class A)

B Index

8

802.1Q VLAN Type.....	6-7
802.3ad.....	1-3

A

Acceptable Frame Type	7-6
Access Control	17-1
Address Learning	16-2
Address Resolution Protocol (ARP)	27-1
Aging Time	6-7
Airflow	3-6
All Connected.....	7-11
ALM.....	3-7
ARP Table.....	27-1
ARP, How it works	27-1
authenticationFailure.....	17-3
Auto-crossover	3-2

B

Back plane.....	A-1
Backup Configuration	23-2
Backup Power Supply (BPS)	3-5
Backup Power Supply Connector	3-6
Bandwidth Control	1-3
Bandwidth Control Setup.....	11-1
Basic Setting	6-1
Bridge ID.....	10-3
Bridge MIBs RFC 1493	1-2
Bridge Priority.....	10-5
Bridge Protocol Data Units (BPDUs)	10-1
Broadcast storm control	1-3
Broadcast Storm Control.....	12-1

C

Classifier	
View summary	19-4

Canonical Format Indicator	7-1
CE	iv
Certification	iv
CFI	<i>See</i> Canonical Format Indicator
Change Login Password.....	4-5
CI Commands	28-3
class A	iv
Class of Service (CoS)	20-1
Classifier	19-1
Ethernet Type.....	19-3
Example	19-5
Packet Format.....	19-2
CLI Command	VII
Configure tagged VLAN example	30-2
Static VLAN Table example.....	30-6
Cluster Management	1-3, 25-1
Cluster member switch	
uploading firmware	25-3
web management.....	25-3
Clustering Management	
ZyXEL Specifications.....	25-1
Cold Start	17-3
Command	
Summary	28-6
Command	
Forwarding Process Example.....	30-6
IEEE 802.1Q Tagged VLAN commands example	
.....	30-1
Syntax conventions	28-3
Command Line Interface	VII
Accessing	28-1
Introduction.....	28-1
config save	3-8
Configure QoS	19-1
Configuring STP	10-4
Console Port.....	1-1, 3-2
Contact Person's Name	6-4
Contacting Customer Support.....	v
Copyright	ii
Cost to Bridge	10-3
Customer Support	v

D

Data Buffer.....	A-2
Daytime (RFC 867).....	6-5
Default Ethernet Settings.....	3-2
Destination Lookup Failure (DLF).....	12-1
DHCP.....	21-1
Diagnostic.....	24-1
DiffServ (Differentiated Services).....	20-1
DiffServ Code Point (DSCP).....	20-1
DiffServ marking rule.....	20-1
Dimensions.....	A-3
Disclaimer.....	ii
DS.....	<i>See</i> Differentiated Services
DS field.....	20-1
DVLAN Table.....	30-1
Dynamic Link Aggregation.....	14-1

E

Egress port.....	7-11
Error Packet.....	5-4
Ethernet Address.....	6-2
Ethernet MIBs RFC 1643.....	1-2
Ethernet Port Test.....	24-1
Exposed Power wire length.....	3-1

F

Fans.....	1-2
FCC Rules.....	iv
FCC Warning.....	iv
Federal Communications Commission (FCC) Interference Statement.....	iv
File Transfer using FTP.....	23-3
command example.....	23-4
GUI-based.....	23-5
procedure.....	23-4
restrictions over WAN.....	23-5
Filename Conventions.....	23-4
Filter Setup.....	9-1
Filtering.....	9-1
View rules.....	9-2
Filtering database.....	<i>See</i> MAC Table

Firmware Upgrade.....	23-1
Flow Control.....	6-13
Forwarding Delay.....	10-3, 10-5
general rule.....	10-5
Firmware version.....	6-2
Front Panel.....	3-1
Front Panel LEDs.....	3-6
FTP.....	23-3

G

GARP.....	30-1. <i>See</i> Generic Attribute Registration Protocol
garp status.....	30-2
GARP Status Command.....	30-3
GARP Terminology.....	7-2
GARP Timer.....	6-8
GBIC (Gigabit Interface Converter).....	1-1
General Setup.....	6-1, 6-3, 6-4
Generic Attribute Registration Protocol.....	7-2
Get Community.....	17-4
GetNext.....	17-3
Gigabit Ports.....	1-1
Gigabit Ports.....	3-2
Graphics Icons Key.....	xv
GS-3012 models.....	xv
GVRP.....	7-5, 30-1
GVRP (GARP VLAN Registration Protocol).....	7-2, 7-6, 29-13
gvrp disable.....	30-4
gvrp enable.....	30-4
gvrp status.....	30-3

H

Hardware Monitor	
Fans.....	6-3
Temperature.....	6-2
Temperature unit.....	6-2
Volatge.....	6-3
Hello Time.....	10-3, 10-5
Help.....	4-8
How SSH works.....	17-6
How STP Works.....	10-1

HTML help	xv, xvi
HTTP	19-5
HTTPS	17-7
HTTPS Example	17-7

I

IEEE 802.1p	6-8
IEEE 802.1Q	<i>See</i> Tagged VLAN
IEEE 802.1Q Tagged VLAN	30-1
IEEE 802.1x	15-1
IGMP (Internet Group Multicast Protocol)	6-6
IGMP snooping	1-3
IGMP Snooping	6-6
Ingress Check	7-6
Ingress filtering	7-2
Installation	
Desktop	2-1
Rack-Mounted	2-1
Installation Scenarios	2-1
IP Address	6-10
IP Ports	19-5
IP Protocols	1-2
IP Setup	6-1, 6-9
IP Subnet Mask	6-10
iStacking	25-1

J

Join Timer	6-8
------------------	-----

L

LACP	
Timeout	14-5
LACP Status	14-2
Leave All Timer	6-8
Leave Timer	6-8
LED Descriptions	3-6
Link Aggregate Control Protocol (LACP),	14-1
Link aggregation	14-1
Link Aggregation ID	14-1
Link aggregation setup	14-4
Link Aggregation Setup	14-3

linkDown	17-3
Location	6-4
Login Accounts	17-4

M

MAC	6-2
MAC address	6-2
MAC address learning	1-3, 8-1
MAC Address Learning	6-7
MAC Address Table	A-2
MAC Table	26-1
MAC table flowchart	26-1
Maintenance	23-1
Management Information Base (MIB)	17-2
Management Port	1-2, 3-5
default IP address	3-5
Max Age	10-2, 10-3, 10-5
MDIX (Media Dependent Interface Crossover)	3-2
Media Access Control	6-2
Media Interface Exchange	A-1
MGNT port	3-5
MIBs	A-2
Mini GBIC slots	3-2
Monitor port	13-1
Mounting Brackets	2-2
MTU (Multi-Tenant Unit)	6-6
Multi-tenant unit (MTU)	xv

N

Navigation Panel Links	4-4
Network Applications	
Bridging	1-4
Backbone	1-3
High Performance Switched Workgroup	1-5
IEEE802.1Q VLAN Application	1-6
VLAN Server	1-7
VLAN Workgroup	1-6
Network Cables	A-1
NTP (RFC-1305)	6-5

	O	PWR.....	3-7
Operating Temperature.....	A-3		
Operational Humidity.....	A-3	Q	
Out of Profile Action.....	20-4	Quality of Service.....	1-3
Out-of-profile traffic.....	20-3	Quality of Service (QoS).....	19-1
	P	Queuing.....	18-1
Packet Forwarding Rate.....	A-2	Queuing algorithms.....	18-1
Password		R	
Default.....	4-1	RADIUS (Remote Authentication Dial-In User	
Path cost.....	10-1	Service).....	15-1
PHB (Per-Hop Behavior).....	20-1	RADIUS Setup.....	15-2
Ping.....	24-1	ras.....	23-4
Policy		Ras.....	23-4
Actions.....	20-3	Rear Panel.....	3-5
Example.....	20-5	Rear Panel Connections.....	3-6
Metering.....	20-3	Reauthentication.....	15-3
View summary.....	20-4	Related Documentation.....	xvi
Policy Rules.....	20-1	Remote Management.....	17-11
POP (point-of-presence).....	xv	repair.....	iii
POP3.....	19-5	Resetting the Switch.....	4-6
Port Based VLAN Type.....	6-7	Restore Configuration.....	23-2
Port Details.....	5-2, 5-3	Revolutions Per Minute (RPM).....	6-3
Port Isolation.....	7-5, 7-11	RJ-45 management port.....	1-2
Port Mirroring.....	1-2, 13-1, 28-22, 29-12	RMON RFC 1757.....	1-2
Port Security.....	16-1	Rom-0.....	23-4
Port Setup.....	6-11, 6-12	Root bridge.....	10-1
Port Statistics.....	<i>See</i> Port Details	Round Robin Scheduling.....	18-1
Port Status.....	5-1. <i>See</i> Port Details	RSTP (Rapid STP).....	1-3
Port Link Aggregation.....	1-3	Rubber Feet.....	2-1
Port VID.....	7-2	Runt.....	5-5
Default for all ports.....	7-1, 28-22	Rx KB/s.....	5-2, 5-4
Port-based VLANs.....	7-9	Rx Packet.....	5-4
Configure.....	7-9	RxPkts.....	5-2, 5-3
Power Connector.....	3-6		
Power Consumption.....	A-3	S	
Power Supply.....	A-3	Safety.....	A-3
Priority.....	6-8	Safety Warnings.....	3-1
Priority Level.....	6-8	Screen Overview.....	4-3
Priority Queue Assignment.....	6-8, 6-13	Secured Client.....	23-5
Product specifications.....	A-1	Server Port.....	17-11
PVID.....	7-6		

Service.....	iii
Service Access Control	17-11
Set Community.....	17-4
Shared Secret.....	15-2
Simple Network Management Protocol	17-2
Small Form-factor Pluggable (SFP).....	3-3
SMI RFC 1155.....	1-2
SNMP.....	17-2
Configuring.....	17-3
Trap.....	17-4
Get.....	17-3
Manager.....	17-2
MIBs.....	17-3
supported versions.....	17-2
Trap.....	17-3
SNMP Commands.....	17-3
SNMP MIB II (RFC 1213).....	1-2
SNMP Traps.....	17-3
SNMP v1 RFC 1157.....	1-2
SNMPv2, SNMPv2c RFC 2674.....	1-2
Source MAC Address.....	9-2
Spanning Tree Protocol.....	10-1
Speed/Duplex.....	6-12
SSH.....	17-5
SSH Implementation.....	17-6
.....	1-1
standard browser.....	4-1
Standards.....	A-1
Static MAC Forward Setup.....	8-1
Static MAC Forwarding.....	8-1
Static Route	
Setup.....	22-1
Summary table.....	22-2
Static VLAN.....	7-6
Control.....	7-7
Summary Table.....	7-8
Tagging.....	7-7
Status.....	5-1
STP.....	<i>See Spanning Tree Protocol</i>
STP (Spanning Tree Protocol).....	1-3
STP Path Costs.....	10-1
STP Port States.....	10-2
STP Status.....	10-2
STP Terminology.....	10-1
Strict Priority Queuing (SPQ).....	18-1

SVLAN Table.....	30-1
Switch Lockout.....	4-6
Switch Setup.....	6-6, 7-3
Switching Method.....	A-2
Synchronized Ports.....	14-3
Syntax Conventions.....	xv
SYS.....	3-7
sys Commands	
examples.....	29-1, 29-7, 29-10
Summary.....	28-6, 28-7, 28-10, 28-19
sys log disp.....	29-2, 29-7, 29-10
sys sw commands	
summary.....	28-21
sys sw mac list.....	29-4
System Information.....	5-1, 6-1
System Log.....	24-1
System Monitoring.....	1-2
System Name.....	6-4
System Priority.....	14-4
System Statistics.....	5-1
System up Time.....	5-1

T

Tag Control Information.....	7-1
Tag Protocol Identifier.....	7-1
Tagged VLAN.....	7-1
GARP.....	7-2
GVRP.....	7-2
Membership Registration.....	7-1
Taiwanese BSMI A Warning.....	iv
TCI.....	<i>See Tag Control Information</i>
TCP/UDP protocol port numbers.....	19-3, 19-4
Terminal emulation.....	3-2
Terminal Emulation.....	3-2
Time (RFC-868).....	6-5
Time server protocol supported.....	6-5
TPID.....	<i>See Tag Protocol Identifier</i>
Trademarks.....	ii
Transceiver Installation.....	3-3
Transceiver MultiSource Agreement (MSA).....	3-3
Transceiver Removal.....	3-4
Trap.....	17-4
Trunking.....	<i>See Link aggregation</i>
trusted computers.....	17-11

TX Collision..... 5-4
 Tx KB/s 5-2, 5-4
 Tx Packet..... 5-4
 TxPkts..... 5-2, 5-3

U

Up Time..... 5-2
 1-1
 Username
 Default..... 4-1

V

ventilation..... 2-1
 ventilation holes 2-1
 VID..... 7-4, 9-2. *See* VLAN Identifier
 VLAN..... 7-1
 Explicit Tagging..... 30-1
 Forwarding 7-1
 ID (VID)..... 30-1
 Implicit Tagging..... 30-1
 Introduction 6-5
 Port-based..... 7-9
 Priority frame 7-1
 Registration Information 30-1
 Tagged VLAN..... 7-1
 VLAN (Virtual Local Area Network) 6-6
 VLAN Administrative Control..... 7-2
 VLAN Databases..... 30-1
 VLAN Group..... 7-7
 VLAN ID..... 6-10, 7-1
 maximum number of 7-1
 VLAN Identifier 7-1
 VLAN Port Settings 7-5
 VLAN Status 7-4

VLAN Tag Control 7-2
 VLAN Type 6-7, 7-3
 vlanlq port accept 30-5
 vlanlq port gvrp 30-5
 vlanlq svlan active 30-7
 vlanlq svlan delentry 30-7
 vlanlq svlan inactive..... 30-7
 vlanlq svlan list..... 30-7
 vlanlq svlan setentry 30-5
 VT100 3-2

W

WarmStart 17-3
 Warnings 3-1
 Web Configurator..... 4-1
 Logging out 4-7
 Login 4-1
 Online help 4-8
 Recommended browsers 4-1
 Weighted Round Robin Scheduling 18-1
 WRR..... *See* Weighted Round Robin Scheduling

X

XMODEM upload..... 4-7

Z

ZyNOS (ZyXEL Network Operating System) 23-4
 ZyNOS Firmware version 6-2
 ZyXEL Limited Warranty iii
 Note iii
 ZyXEL Web Site..... xvi