

# *ES-3148*

*Intelligent Layer 2+ Switch  
48-port Fast Ethernet +  
2 Gigabit Ethernet Ports  
2 GbE Dual Personality Interfaces (Copper/SFP)*

## *User's Guide*

Version 3.70  
8/2006  
Edition 1

The logo for ZyXEL, featuring the word "ZyXEL" in a bold, blue, sans-serif font. The "Z" and "y" are lowercase, while "XEL" are uppercase. The letters are closely spaced and have a slight shadow effect.



# Copyright

Copyright © 2006 by ZyXEL Communications Corporation.

The contents of this publication may not be reproduced in any part or as a whole, transcribed, stored in a retrieval system, translated into any language, or transmitted in any form or by any means, electronic, mechanical, magnetic, optical, chemical, photocopying, manual, or otherwise, without the prior written permission of ZyXEL Communications Corporation.

Published by ZyXEL Communications Corporation. All rights reserved.

## **Disclaimer**

ZyXEL does not assume any liability arising out of the application or use of any products, or software described herein. Neither does it convey any license under its patent rights nor the patent rights of others. ZyXEL further reserves the right to make changes in any products described herein without notice. This publication is subject to change without notice.

## **Trademarks**

ZyNOS (ZyXEL Network Operating System) is a registered trademark of ZyXEL Communications, Inc. Other trademarks mentioned in this publication are used for identification purposes only and may be properties of their respective owners.

# Certifications

## Federal Communications Commission (FCC) Interference Statement

This device complies with Part 15 of FCC rules. Operation is subject to the following two conditions:

- This device may not cause harmful interference.
- This device must accept any interference received, including interference that may cause undesired operations.

## FCC Warning

This device has been tested and found to comply with the limits for a Class A digital switch, pursuant to Part 15 of the FCC Rules. These limits are designed to provide reasonable protection against harmful interference in a commercial environment. This device generates, uses, and can radiate radio frequency energy and, if not installed and used in accordance with the instruction manual, may cause harmful interference to radio communications. Operation of this device in a residential area is likely to cause harmful interference in which case the user will be required to correct the interference at his own expense.

## CE Mark Warning:

This is a class A product. In a domestic environment this product may cause radio interference in which case the user may be required to take adequate measures.

## Taiwanese BSMI (Bureau of Standards, Metrology and Inspection) A Warning:

警告使用者  
這是甲類的資訊產品，在居住的環境使用時，  
可能造成射頻干擾，在這種情況下，  
使用者會被要求採取某些適當的對策。

## Notices

Changes or modifications not expressly approved by the party responsible for compliance could void the user's authority to operate the equipment.

This Class A digital apparatus complies with Canadian ICES-003.

Cet appareil numérique de la classe A est conforme à la norme NMB-003 du Canada.

## Viewing Certifications

- 1 Go to <http://www.zyxel.com>.
- 2 Select your product from the drop-down list box on the ZyXEL home page to go to that product's page.
- 3 Select the certification you wish to view from this page.

# Safety Warnings

For your safety, be sure to read and follow all warning notices and instructions.

- Do NOT use this product near water, for example, in a wet basement or near a swimming pool.
- Do NOT expose your device to dampness, dust or corrosive liquids.
- Do NOT store things on the device.
- Do NOT install, use, or service this device during a thunderstorm. There is a remote risk of electric shock from lightning.
- Connect ONLY suitable accessories to the device.
- Do NOT open the device or unit. Opening or removing covers can expose you to dangerous high voltage points or other risks. ONLY qualified service personnel should service or disassemble this device. Please contact your vendor for further information.
- Make sure to connect the cables to the correct ports.
- Place connecting cables carefully so that no one will step on them or stumble over them.
- Always disconnect all cables from this device before servicing or disassembling.
- Use ONLY an appropriate power adaptor or cord for your device.
- Connect the power adaptor or cord to the right supply voltage (for example, 110V AC in North America or 230V AC in Europe).
- Do NOT allow anything to rest on the power adaptor or cord and do NOT place the product where anyone can walk on the power adaptor or cord.
- Do NOT use the device if the power adaptor or cord is damaged as it might cause electrocution.
- If the power adaptor or cord is damaged, remove it from the power outlet.
- Do NOT attempt to repair the power adaptor or cord. Contact your local vendor to order a new one.
- Do not use the device outside, and make sure all the connections are indoors. There is a remote risk of electric shock from lightning.
- **CAUTION: RISK OF EXPLOSION IF BATTERY (on the motherboard) IS REPLACED BY AN INCORRECT TYPE. DISPOSE OF USED BATTERIES ACCORDING TO THE INSTRUCTIONS.** Dispose them at the applicable collection point for the recycling of electrical and electronic equipment. For detailed information about recycling of this product, please contact your local city office, your household waste disposal service or the store where you purchased the product.
- Do NOT obstruct the device ventilation slots, as insufficient airflow may harm your device.

This product is recyclable. Dispose of it properly.

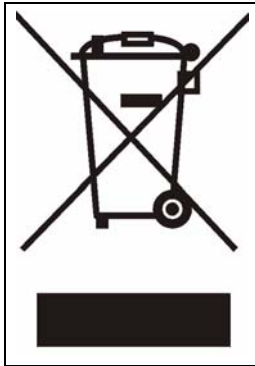

# ZyXEL Limited Warranty

ZyXEL warrants to the original end user (purchaser) that this product is free from any defects in materials or workmanship for a period of up to two years from the date of purchase. During the warranty period, and upon proof of purchase, should the product have indications of failure due to faulty workmanship and/or materials, ZyXEL will, at its discretion, repair or replace the defective products or components without charge for either parts or labor, and to whatever extent it shall deem necessary to restore the product or components to proper operating condition. Any replacement will consist of a new or re-manufactured functionally equivalent product of equal or higher value, and will be solely at the discretion of ZyXEL. This warranty shall not apply if the product has been modified, misused, tampered with, damaged by an act of God, or subjected to abnormal working conditions.

## Note

Repair or replacement, as provided under this warranty, is the exclusive remedy of the purchaser. This warranty is in lieu of all other warranties, express or implied, including any implied warranty of merchantability or fitness for a particular use or purpose. ZyXEL shall in no event be held liable for indirect or consequential damages of any kind to the purchaser.

To obtain the services of this warranty, contact ZyXEL's Service Center for your Return Material Authorization number (RMA). Products must be returned Postage Prepaid. It is recommended that the unit be insured when shipped. Any returned products without proof of purchase or those with an out-dated warranty will be repaired or replaced (at the discretion of ZyXEL) and the customer will be billed for parts and labor. All repaired or replaced products will be shipped by ZyXEL to the corresponding return address, Postage Paid. This warranty gives you specific legal rights, and you may also have other rights that vary from country to country.

## Registration

Register your product online to receive e-mail notices of firmware upgrades and information at [www.zyxel.com](http://www.zyxel.com) for global products, or at [www.us.zyxel.com](http://www.us.zyxel.com) for North American products.

# Customer Support

Please have the following information ready when you contact customer support.

- Product model and serial number.
- Warranty Information.
- Date that you received your device.
- Brief description of the problem and the steps you took to solve it.

METHOD	SUPPORT E-MAIL	TELEPHONE	WEB SITE	REGULAR MAIL
LOCATION	SALES E-MAIL	FAX	FTP SITE	
CORPORATE HEADQUARTERS (WORLDWIDE)	support@zyxel.com.tw	+886-3-578-3942	www.zyxel.com www.europe.zyxel.com	ZyXEL Communications Corp. 6 Innovation Road II Science Park Hsinchu 300 Taiwan
	sales@zyxel.com.tw	+886-3-578-2439	ftp.zyxel.com ftp.europe.zyxel.com	
COSTA RICA	soporte@zyxel.co.cr	+506-2017878	www.zyxel.co.cr	ZyXEL Costa Rica Plaza Roble Escazú Etapa El Patio, Tercer Piso San José, Costa Rica
	sales@zyxel.co.cr	+506-2015098	ftp.zyxel.co.cr	
CZECH REPUBLIC	info@cz.zyxel.com	+420-241-091-350	www.zyxel.cz	ZyXEL Communications Czech s.r.o. Modranská 621 143 01 Praha 4 - Modrany Ceská Republika
	info@cz.zyxel.com	+420-241-091-359		
DENMARK	support@zyxel.dk	+45-39-55-07-00	www.zyxel.dk	ZyXEL Communications A/S Columbusvej 2860 Soeborg Denmark
	sales@zyxel.dk	+45-39-55-07-07		
FINLAND	support@zyxel.fi	+358-9-4780-8411	www.zyxel.fi	ZyXEL Communications Oy Malminkaari 10 00700 Helsinki Finland
	sales@zyxel.fi	+358-9-4780 8448		
FRANCE	info@zyxel.fr	+33-4-72-52-97-97	www.zyxel.fr	ZyXEL France 1 rue des Vergers Bat. 1 / C 69760 Limonest France
		+33-4-72-52-19-20		
GERMANY	support@zyxel.de	+49-2405-6909-0	www.zyxel.de	ZyXEL Deutschland GmbH. Adenauerstr. 20/A2 D-52146 Wuerselen Germany
	sales@zyxel.de	+49-2405-6909-99		
HUNGARY	support@zyxel.hu	+36-1-3361649	www.zyxel.hu	ZyXEL Hungary 48, Zoldomb Str. H-1025, Budapest Hungary
	info@zyxel.hu	+36-1-3259100		
KAZAKHSTAN	http://zyxel.kz/support	+7-3272-590-698	www.zyxel.kz	ZyXEL Kazakhstan 43, Dostyk ave., Office 414 Dostyk Business Centre 050010, Almaty Republic of Kazakhstan
	sales@zyxel.kz	+7-3272-590-689		
NORTH AMERICA	support@zyxel.com	1-800-255-4101 +1-714-632-0882	www.us.zyxel.com	ZyXEL Communications Inc. 1130 N. Miller St. Anaheim CA 92806-2001 U.S.A.
	sales@zyxel.com	+1-714-632-0858	ftp.us.zyxel.com	



METHOD	SUPPORT E-MAIL	TELEPHONE	WEB SITE	REGULAR MAIL
	SALES E-MAIL	FAX	FTP SITE	
NORWAY	support@zyxel.no	+47-22-80-61-80	www.zyxel.no	ZyXEL Communications A/S Niils Hansens vei 13 0667 Oslo Norway
	sales@zyxel.no	+47-22-80-61-81		
POLAND	info@pl.zyxel.com	+48 (22) 333 8250	www.pl.zyxel.com	ZyXEL Communications ul. Okrzei 1A 03-715 Warszawa Poland
		+48 (22) 333 8251		
RUSSIA	http://zyxel.ru/support	+7-095-542-89-29	www.zyxel.ru	ZyXEL Russia Ostrovityanova 37a Str. Moscow, 117279 Russia
	sales@zyxel.ru	+7-095-542-89-25		
SPAIN	support@zyxel.es	+34-902-195-420	www.zyxel.es	ZyXEL Communications Arte, 21 5ª planta 28033 Madrid Spain
	sales@zyxel.es	+34-913-005-345		
SWEDEN	support@zyxel.se	+46-31-744-7700	www.zyxel.se	ZyXEL Communications A/S Sjöporten 4, 41764 Göteborg Sweden
	sales@zyxel.se	+46-31-744-7701		
UKRAINE	support@ua.zyxel.com	+380-44-247-69-78	www.ua.zyxel.com	ZyXEL Ukraine 13, Pimonenko Str. Kiev, 04050 Ukraine
	sales@ua.zyxel.com	+380-44-494-49-32		
UNITED KINGDOM	support@zyxel.co.uk	+44-1344 303044 08707 555779 (UK only)	www.zyxel.co.uk	ZyXEL Communications UK Ltd., 11 The Courtyard, Eastern Road, Bracknell, Berkshire, RG12 2XB, United Kingdom (UK)
	sales@zyxel.co.uk	+44-1344 303034	ftp.zyxel.co.uk	

+” is the (prefix) number you enter to make an international telephone call.



# Table of Contents

<b>Copyright .....</b>	<b>3</b>
<b>Certifications .....</b>	<b>4</b>
<b>Safety Warnings .....</b>	<b>5</b>
<b>ZyXEL Limited Warranty .....</b>	<b>7</b>
<b>Customer Support.....</b>	<b>8</b>
<b>Table of Contents .....</b>	<b>11</b>
<b>List of Figures .....</b>	<b>23</b>
<b>List of Tables .....</b>	<b>27</b>
<b>Preface .....</b>	<b>31</b>
<b>Chapter 1</b>	
<b>Getting to Know Your Switch .....</b>	<b>33</b>
1.1 Introduction .....	33
1.2 Software Features .....	33
1.3 Hardware Features .....	37
1.4 Applications .....	37
1.4.1 Backbone Application .....	38
1.4.2 Bridging Example .....	38
1.4.3 High Performance Switched Example .....	39
1.4.4 IEEE 802.1Q VLAN Application Examples .....	39
1.4.4.1 Tag-based VLAN Example .....	40
1.4.4.2 VLAN Shared Server Example .....	40
<b>Chapter 2</b>	
<b>Hardware Installation and Connection.....</b>	<b>43</b>
2.1 Freestanding Installation .....	43
2.2 Mounting the Switch on a Rack .....	44
2.2.1 Rack-mounted Installation Requirements .....	44
2.2.1.1 Precautions .....	44
2.2.2 Attaching the Mounting Brackets to the Switch .....	44
2.2.3 Mounting the Switch on a Rack .....	44

<b>Chapter 3</b>	
<b>Hardware Overview .....</b>	<b>47</b>
3.1 Panel Connections .....	47
3.1.1 Ethernet Ports .....	47
3.1.1.1 Default Ethernet Settings .....	48
3.1.2 Mini-GBIC Slots .....	48
3.1.2.1 Transceiver Installation .....	48
3.1.2.2 Transceiver Removal .....	49
3.2 Rear Panel .....	50
3.2.1 Console Port .....	50
3.2.2 External Backup Power Supply Connector .....	51
3.2.3 Power Connector .....	51
3.3 LEDs .....	51
<b>Chapter 4</b>	
<b>The Web Configurator.....</b>	<b>53</b>
4.1 Introduction .....	53
4.2 System Login .....	53
4.3 The Status Screen .....	54
4.4 Menu Overview .....	55
4.4.1 Change Your Password .....	58
4.5 Saving Your Configuration .....	59
4.6 Switch Lockout .....	59
4.7 Resetting the Switch .....	60
4.7.1 Reload the Configuration File .....	60
4.7.2 Reset to the Factory Defaults .....	61
4.8 Logging Out of the Web Configurator .....	62
4.9 Help .....	62
<b>Chapter 5</b>	
<b>Initial Setup Example .....</b>	<b>63</b>
5.1 Overview .....	63
5.1.1 Creating a VLAN .....	63
5.1.2 Setting Port VID .....	64
5.2 Configuring Switch Management IP Address .....	65
<b>Chapter 6</b>	
<b>System Status and Port Statistics .....</b>	<b>67</b>
6.1 Port Status Summary .....	67
6.1.1 Status: Port Details .....	68

<b>Chapter 7</b>	
<b>Basic Setting .....</b>	<b>73</b>
7.1 Overview .....	73
7.2 System Information .....	73
7.3 General Setup .....	75
7.4 Introduction to VLANs .....	77
7.5 Switch Setup Screen .....	78
7.6 IP Setup .....	80
7.6.1 Management IP Addresses .....	80
7.7 Port Setup .....	83
<b>Chapter 8</b>	
<b>VLAN .....</b>	<b>87</b>
8.1 Introduction to IEEE 802.1Q Tagged VLAN .....	87
8.1.1 Forwarding Tagged and Untagged Frames .....	87
8.2 Automatic VLAN Registration .....	88
8.2.1 GARP .....	88
8.2.1.1 GARP Timers .....	88
8.2.2 GVRP .....	88
8.3 Port VLAN Trunking .....	89
8.4 Select the VLAN Type .....	89
8.5 Static VLAN .....	90
8.5.1 Static VLAN Status .....	90
8.5.2 Static VLAN Details .....	91
8.5.3 Configure a Static VLAN .....	91
8.5.4 Configure VLAN Port Settings .....	93
8.6 Protocol Based VLANs .....	95
8.7 Configuring Protocol Based VLAN .....	95
8.8 Create an IP-based VLAN Example .....	97
8.9 Port-based VLAN Setup .....	98
8.9.1 Configure a Port-based VLAN .....	98
<b>Chapter 9</b>	
<b>Static MAC Forwarding .....</b>	<b>103</b>
9.1 Configuring Static MAC Forwarding .....	103
<b>Chapter 10</b>	
<b>Filtering .....</b>	<b>105</b>
10.1 Configure a Filtering Rule .....	105
<b>Chapter 11</b>	
<b>Spanning Tree Protocol .....</b>	<b>107</b>
11.1 STP/RSTP Overview .....	107

11.1.1 STP Terminology .....	107
11.1.2 How STP Works .....	108
11.1.3 STP Port States .....	108
11.1.4 Multiple RSTP .....	109
11.2 Spanning Tree Protocol Main Screen .....	109
11.3 Configure Rapid Spanning Tree Protocol .....	110
11.4 Rapid Spanning Tree Protocol Status .....	112
11.5 Configure Multiple Rapid Spanning Tree Protocol .....	113
11.6 Multiple Rapid Spanning Tree Protocol Status .....	115
<b>Chapter 12</b>	
<b>Bandwidth Control .....</b>	<b>117</b>
12.1 Bandwidth Control Overview .....	117
12.1.1 CIR and PIR .....	117
12.2 Bandwidth Control Setup .....	117
<b>Chapter 13</b>	
<b>Broadcast Storm Control.....</b>	<b>121</b>
13.1 Broadcast Storm Control Setup .....	121
<b>Chapter 14</b>	
<b>Mirroring .....</b>	<b>123</b>
14.1 Port Mirroring Setup .....	123
<b>Chapter 15</b>	
<b>Link Aggregation.....</b>	<b>125</b>
15.1 Link Aggregation Overview .....	125
15.2 Dynamic Link Aggregation .....	125
15.2.1 Link Aggregation ID .....	126
15.3 Link Aggregation Control Protocol Status .....	126
15.4 Link Aggregation Setup .....	127
<b>Chapter 16</b>	
<b>Port Authentication .....</b>	<b>131</b>
16.1 Port Authentication Overview .....	131
16.1.1 RADIUS .....	131
16.1.1.1 Vendor Specific Attribute .....	131
16.1.1.2 Tunnel Protocol Attribute .....	132
16.2 Port Authentication Configuration .....	132
16.2.1 Configuring RADIUS Server Settings .....	133
16.2.2 Activate IEEE 802.1x Security .....	134

<b>Chapter 17</b>	
<b>Port Security</b> .....	<b>137</b>
17.1 About Port Security .....	137
17.2 Port Security Setup .....	137
<b>Chapter 18</b>	
<b>Classifier</b> .....	<b>141</b>
18.1 About the Classifier and QoS .....	141
18.2 Configuring the Classifier .....	141
18.3 Viewing and Editing Classifier Configuration .....	144
18.4 Classifier Example .....	145
<b>Chapter 19</b>	
<b>Policy Rule</b> .....	<b>147</b>
19.1 Policy Rules Overview .....	147
19.1.1 DiffServ .....	147
19.1.2 DSCP and Per-Hop Behavior .....	147
19.2 Configuring Policy Rules .....	148
19.3 Viewing and Editing Policy Configuration .....	151
19.4 Policy Example .....	152
<b>Chapter 20</b>	
<b>Queuing Method</b> .....	<b>155</b>
20.1 Queuing Method Overview .....	155
20.1.1 Strictly Priority .....	155
20.1.2 Weighted Fair Scheduling .....	155
20.1.3 Weighted Round Robin Scheduling (WRR) .....	156
20.2 Configuring Queuing .....	156
<b>Chapter 21</b>	
<b>VLAN Stacking</b> .....	<b>159</b>
21.1 VLAN Stacking Overview .....	159
21.1.1 VLAN Stacking Example .....	159
21.2 VLAN Stacking Port Roles .....	160
21.3 VLAN Tag Format .....	160
21.3.1 Frame Format .....	161
21.4 Configuring VLAN Stacking .....	162
<b>Chapter 22</b>	
<b>Multicast</b> .....	<b>165</b>
22.1 Multicast Overview .....	165
22.1.1 IP Multicast Addresses .....	165
22.1.2 IGMP Filtering .....	165

22.1.3 IGMP Snooping .....	165
22.2 Multicast Status .....	166
22.3 Multicast Setting .....	166
22.4 IGMP Filtering Profile .....	169
22.5 MVR Overview .....	170
22.5.1 Types of MVR Ports .....	170
22.5.2 MVR Modes .....	171
22.5.3 How MVR Works .....	171
22.6 General MVR Configuration .....	171
22.7 MVR Group Configuration .....	173
22.7.1 MVR Configuration Example .....	175
<b>Chapter 23</b>	
<b>DHCP Relay .....</b>	<b>179</b>
23.1 DHCP Relay Overview .....	179
23.1.1 DHCP Relay Agent Information .....	179
23.2 DHCP Relay Configuration .....	179
<b>Chapter 24</b>	
<b>Static Route .....</b>	<b>181</b>
24.1 Configuring Static Route .....	181
<b>Chapter 25</b>	
<b>DiffServ Code Point .....</b>	<b>183</b>
25.1 DiffServ Overview .....	183
25.2 Enable DiffServ .....	183
25.3 Configure DSCP Setting .....	184
<b>Chapter 26</b>	
<b>Maintenance .....</b>	<b>187</b>
26.1 The Maintenance Screen .....	187
26.2 Load Factory Defaults .....	188
26.3 Save Configuration .....	188
26.4 Reboot System .....	189
26.5 Firmware Upgrade .....	189
26.6 Restore a Configuration File .....	190
26.7 Backup a Configuration File .....	190
26.8 FTP Command Line .....	191
26.8.1 Filename Conventions .....	191
26.8.1.1 Example FTP Commands .....	192
26.8.2 FTP Command Line Procedure .....	192
26.8.3 GUI-based FTP Clients .....	193
26.8.4 FTP Restrictions .....	193



<b>Chapter 27</b>	
<b>Access Control.....</b>	<b>195</b>
27.1 Access Control Overview .....	195
27.2 The Access Control Main Screen .....	195
27.3 About SNMP .....	196
27.3.1 Supported MIBs .....	197
27.3.2 SNMP Traps .....	197
27.3.3 Configuring SNMP .....	198
27.3.4 Setting Up Login Accounts .....	198
27.4 SSH Overview .....	200
27.5 How SSH works .....	200
27.6 SSH Implementation on the Switch .....	201
27.6.1 Requirements for Using SSH .....	202
27.7 Introduction to HTTPS .....	202
27.8 HTTPS Example .....	203
27.8.1 Internet Explorer Warning Messages .....	203
27.8.2 Netscape Navigator Warning Messages .....	203
27.8.3 The Main Screen .....	204
27.9 Service Port Access Control .....	205
27.10 Remote Management .....	206
<b>Chapter 28</b>	
<b>Diagnostic.....</b>	<b>209</b>
28.1 Diagnostic .....	209
<b>Chapter 29</b>	
<b>Syslog.....</b>	<b>211</b>
29.1 Syslog Overview .....	211
29.2 Syslog Setup .....	211
29.3 Syslog Server Setup .....	212
<b>Chapter 30</b>	
<b>Cluster Management.....</b>	<b>215</b>
30.1 Cluster Management Status Overview .....	215
30.2 Cluster Management Status .....	216
30.2.1 Cluster Member Switch Management .....	217
30.2.1.1 Uploading Firmware to a Cluster Member Switch .....	218
30.3 Clustering Management Configuration .....	219
<b>Chapter 31</b>	
<b>MAC Table.....</b>	<b>223</b>
31.1 MAC Table Overview .....	223
31.2 Viewing the MAC Table .....	224

<b>Chapter 32</b>	
<b>ARP Table.....</b>	<b>225</b>
32.1 ARP Table Overview .....	225
32.1.1 How ARP Works .....	225
32.2 Viewing the ARP Table .....	225
<b>Chapter 33</b>	
<b>Configure Clone .....</b>	<b>227</b>
33.1 Configure Clone .....	227
<b>Chapter 34</b>	
<b>Introducing Commands.....</b>	<b>229</b>
34.1 Overview .....	229
34.2 Accessing the CLI .....	229
34.2.1 The Console Port .....	229
34.2.1.1 Initial Screen .....	230
34.3 The Login Screen .....	230
34.4 Command Syntax Conventions .....	230
34.5 Changing the Password .....	231
34.6 Privilege Levels .....	231
34.7 Command Modes .....	232
34.8 Getting Help .....	233
34.8.1 List of Available Commands .....	234
34.9 Using Command History .....	236
34.10 Saving Your Configuration .....	236
34.10.1 Switch Configuration File .....	236
34.10.2 Logging Out .....	237
34.11 Command Summary .....	237
34.11.1 User Mode .....	237
34.11.2 Enable Mode .....	238
34.11.3 General Configuration Mode .....	243
34.11.4 interface port-channel Commands .....	255
34.11.5 config-vlan Commands .....	259
34.11.6 mvr Commands .....	260
<b>Chapter 35</b>	
<b>User and Enable Mode Commands.....</b>	<b>263</b>
35.1 Overview .....	263
35.2 show Commands .....	263
35.2.1 show system-information .....	263
35.2.2 show ip .....	264
35.2.3 show logging .....	264
35.2.4 show interface .....	264

35.2.5 show mac address-table .....	265
35.3 ping .....	266
35.4 traceroute .....	266
35.5 Copy Port Attributes .....	267
35.6 Configuration File Maintenance .....	268
35.6.1 Using a Different Configuration File .....	268
35.6.2 Resetting to the Factory Default .....	269
<b>Chapter 36</b>	
<b>Configuration Mode Commands.....</b>	<b>271</b>
36.1 Enabling IGMP Snooping .....	271
36.2 Configure IGMP Filter .....	272
36.3 Enabling STP .....	273
36.4 no Command Examples .....	275
36.4.1 Disable Commands .....	275
36.4.2 Resetting Commands .....	275
36.4.3 Re-enable commands .....	275
36.4.4 Other Examples of no Commands .....	276
36.4.4.1 no trunk .....	276
36.4.4.2 no port-access-authenticator .....	277
36.4.4.3 no ssh .....	277
36.5 Queuing Method Commands .....	278
36.6 Static Route Commands .....	278
36.7 Enabling MAC Filtering .....	279
36.8 Enabling Trunking .....	280
36.9 Enabling Port Authentication .....	281
36.9.1 RADIUS Server Settings .....	281
36.9.2 Port Authentication Settings .....	282
<b>Chapter 37</b>	
<b>Interface Commands.....</b>	<b>285</b>
37.1 Overview .....	285
37.2 Interface Command Examples .....	285
37.2.1 interface port-channel .....	285
37.2.2 bpdu-control .....	285
37.2.3 broadcast-limit .....	286
37.2.4 bandwidth-limit .....	286
37.2.5 mirror .....	287
37.2.6 gvrp .....	288
37.2.7 ingress-check .....	288
37.2.8 frame-type .....	289
37.2.9 weight .....	289
37.2.10 egress set .....	290

37.2.11 qos priority .....	290
37.2.12 name .....	291
37.2.13 speed-duplex .....	291
37.2.14 test .....	291
37.3 Interface no Command Examples .....	292
37.3.1 no bandwidth-limit .....	292
<b>Chapter 38</b>	
<b>IEEE 802.1Q Tagged VLAN Commands .....</b>	<b>293</b>
38.1 Configuring Tagged VLAN .....	293
38.2 Global VLAN1Q Tagged VLAN Configuration Commands .....	294
38.2.1 GARP Status .....	294
38.2.2 GARP Timer .....	294
38.2.3 GVRP Timer .....	295
38.2.4 Enable GVRP .....	295
38.2.5 Disable GVRP .....	295
38.3 Port VLAN Commands .....	295
38.3.1 Set Port VID .....	296
38.3.2 Set Acceptable Frame Type .....	296
38.3.3 Enable or Disable Port GVRP .....	296
38.3.4 Modify Static VLAN .....	297
38.3.4.1 Modify a Static VLAN Table Example .....	297
38.3.4.2 Forwarding Process Example .....	297
38.3.5 Delete VLAN ID .....	298
38.4 Enable VLAN .....	298
38.5 Disable VLAN .....	299
38.6 Show VLAN Setting .....	299
<b>Chapter 39</b>	
<b>Multicast VLAN Registration Commands .....</b>	<b>301</b>
39.1 Overview .....	301
39.2 Create Multicast VLAN .....	301
<b>Chapter 40</b>	
<b>Troubleshooting .....</b>	<b>303</b>
40.1 Problems Starting Up the Switch .....	303
40.2 Problems Accessing the Switch .....	303
40.2.1 Pop-up Windows, JavaScripts and Java Permissions .....	304
40.2.1.1 Internet Explorer Pop-up Blockers .....	304
40.2.1.2 JavaScripts .....	307
40.2.1.3 Java Permissions .....	309
40.3 Problems with the Password .....	311

**Appendix A**  
**Product Specifications ..... 313**

**Appendix B**  
**IP Addresses and Subnetting ..... 317**

**Index ..... 325**



# List of Figures

Figure 1 Backbone Application .....	38
Figure 2 Bridging Application .....	39
Figure 3 High Performance Switched Application .....	39
Figure 4 Tag-based VLAN Application .....	40
Figure 5 Shared Server Using VLAN Example .....	41
Figure 6 Attaching Rubber Feet .....	43
Figure 7 Attaching the Mounting Brackets s .....	44
Figure 8 Mounting the Switch on a Rack .....	45
Figure 9 Front Panel .....	47
Figure 10 Transceiver Installation Example .....	49
Figure 11 Installed Transceiver .....	49
Figure 12 Opening the Transceiver's Latch Example .....	49
Figure 13 Transceiver Removal Example .....	49
Figure 14 Rear Panel .....	50
Figure 15 Web Configurator: Login .....	53
Figure 16 Web Configurator Home Screen (Status) .....	54
Figure 17 Change Administrator Login Password .....	59
Figure 18 Example Xmodem Upload .....	61
Figure 19 Reload the Configuration file: Via Console Port .....	61
Figure 20 Resetting the Switch: Via the Console Port .....	62
Figure 21 Web Configurator: Logout Screen .....	62
Figure 22 Initial Setup Network Example: VLAN .....	63
Figure 23 Initial Setup Network Example: Port VID .....	65
Figure 24 Initial Setup Example: Management IP Address .....	65
Figure 25 Status .....	67
Figure 26 Status: Port Details .....	69
Figure 27 System Info .....	74
Figure 28 General Setup .....	76
Figure 29 Switch Setup .....	78
Figure 30 IP Setup .....	81
Figure 31 Port Setup .....	84
Figure 32 Port VLAN Trunking .....	89
Figure 33 Switch Setup: Select VLAN Type .....	89
Figure 34 VLAN: VLAN Status .....	90
Figure 35 Static VLAN Details .....	91
Figure 36 VLAN: Static VLAN .....	92
Figure 37 VLAN: VLAN Port Setting .....	93
Figure 38 Protocol Based VLAN Application Example .....	95

Figure 39 Protocol Based VLAN .....	96
Figure 40 Protocol Based VLAN Configuration Example .....	97
Figure 41 Port Based VLAN Setup (All Connected) .....	99
Figure 42 Port Based VLAN Setup (Port Isolation) .....	100
Figure 43 Static MAC Forwarding .....	103
Figure 44 Filtering .....	105
Figure 45 MRSTP Network Example .....	109
Figure 46 Spanning Tree Protocol RSTP and MRSTP .....	110
Figure 47 RSTP: Configuration .....	111
Figure 48 Rapid Spanning Tree Protocol: Status .....	113
Figure 49 MRSTP: Configuration .....	114
Figure 50 MRSTP: Status .....	116
Figure 51 Bandwidth Control .....	118
Figure 52 Broadcast Storm Control .....	121
Figure 53 Mirroring .....	123
Figure 54 Link Aggregation Control Protocol Status .....	126
Figure 55 Link Aggregation: Configuration .....	128
Figure 56 RADIUS Server .....	131
Figure 57 Port Authentication .....	133
Figure 58 Port Authentication: RADIUS .....	133
Figure 59 Port Authentication: 802.1x .....	134
Figure 60 Port Security .....	138
Figure 61 Classifier .....	142
Figure 62 Classifier: Summary Table .....	144
Figure 63 Classifier: Example .....	146
Figure 64 Policy .....	149
Figure 65 Policy: Summary Table .....	151
Figure 66 Policy Example .....	153
Figure 67 Queuing Method .....	157
Figure 68 VLAN Stacking Example .....	160
Figure 69 VLAN Stacking .....	162
Figure 70 Multicast Status. ....	166
Figure 71 Multicast Setting .....	167
Figure 72 Multicast: IGMP Filtering Profile .....	169
Figure 73 MVR Network Example .....	170
Figure 74 MVR Multicast Television Example .....	171
Figure 75 MVR .....	172
Figure 76 MVR: Group Configuration .....	174
Figure 77 MVR Configuration Example .....	175
Figure 78 MVR Configuration Example .....	176
Figure 79 MVR Group Configuration Example .....	177
Figure 80 MVR Group Configuration Example .....	177
Figure 81 DHCP Relay .....	180



Figure 82 Static Routing .....	181
Figure 83 DiffServ .....	183
Figure 84 DiffServ .....	184
Figure 85 Maintenance .....	187
Figure 86 Load Factory Default: Start .....	188
Figure 87 Reboot System: Confirmation .....	189
Figure 88 Firmware Upgrade .....	190
Figure 89 Restore Configuration .....	190
Figure 90 Backup Configuration .....	191
Figure 91 Access Control .....	195
Figure 92 SNMP Management Model .....	196
Figure 93 Access Control: SNMP .....	198
Figure 94 Access Control: Logins .....	199
Figure 95 SSH Communication Example .....	200
Figure 96 How SSH Works .....	201
Figure 97 HTTPS Implementation .....	202
Figure 98 Security Alert Dialog Box (Internet Explorer) .....	203
Figure 99 Security Certificate 1 (Netscape) .....	204
Figure 100 Security Certificate 2 (Netscape) .....	204
Figure 101 Example: Lock Denoting a Secure Connection .....	205
Figure 102 Access Control: Service Access Control .....	206
Figure 103 Access Control: Remote Management .....	207
Figure 104 Diagnostic .....	209
Figure 105 Syslog .....	212
Figure 106 Syslog: Server Setup .....	213
Figure 107 Clustering Application Example .....	216
Figure 108 Cluster Management: Status .....	217
Figure 109 Cluster Management: Cluster Member Web Configurator Screen .....	218
Figure 110 Example: Uploading Firmware to a Cluster Member Switch .....	219
Figure 111 Clustering Management Configuration .....	220
Figure 112 MAC Table Flowchart .....	223
Figure 113 MAC Table .....	224
Figure 114 ARP Table .....	226
Figure 115 Configure Clone .....	227
Figure 116 no port-access-authenticator Command Example .....	277
Figure 117 Pop-up Blocker .....	304
Figure 118 Internet Options .....	305
Figure 119 Internet Options .....	306
Figure 120 Pop-up Blocker Settings .....	307
Figure 121 Internet Options .....	308
Figure 122 Security Settings - Java Scripting .....	309
Figure 123 Security Settings - Java .....	310
Figure 124 Java (Sun) .....	311



# List of Tables

Table 1 Front Panel .....	47
Table 2 Rear Panel .....	50
Table 3 LEDs .....	51
Table 4 Navigation Panel Sub-links Overview .....	55
Table 5 Web Configurator Screen Sub-links Details .....	56
Table 6 Navigation Panel Links .....	57
Table 7 Status .....	67
Table 8 Status: Port Details .....	69
Table 9 System Info .....	74
Table 10 General Setup .....	76
Table 11 Switch Setup .....	78
Table 12 IP Setup .....	82
Table 13 Port Setup .....	84
Table 14 IEEE 802.1Q VLAN Terminology .....	88
Table 15 VLAN: VLAN Status .....	90
Table 16 Static VLAN Details .....	91
Table 17 VLAN: Static VLAN .....	92
Table 18 VLAN: VLAN Port Setting .....	94
Table 19 Protocol Based VLAN Setup .....	96
Table 20 Port Based VLAN Setup .....	101
Table 21 Static MAC Forwarding .....	104
Table 22 Filtering .....	105
Table 23 STP Path Costs .....	107
Table 24 STP Port States .....	108
Table 25 Spanning Tree Protocol: Status .....	110
Table 26 RSTP: Configuration .....	111
Table 27 Rapid Spanning Tree Protocol: Status .....	113
Table 28 MRSTP: Configuration .....	114
Table 29 Spanning Tree Protocol: Status .....	116
Table 30 Bandwidth Control .....	118
Table 31 Broadcast Storm Control .....	122
Table 32 Mirroring .....	124
Table 33 Link Aggregation ID: Local Switch .....	126
Table 34 Link Aggregation ID: Peer Switch .....	126
Table 35 Link Aggregation Control Protocol Status .....	127
Table 36 Link Aggregation Control Protocol: Configuration .....	128
Table 37 Supported VSA .....	132
Table 38 Supported Tunnel Protocol Attribute .....	132

Table 39 Port Authentication: RADIUS .....	133
Table 40 Port Authentication: 802.1x .....	134
Table 41 Port Security .....	138
Table 42 Classifier .....	142
Table 43 Classifier: Summary Table .....	144
Table 44 Common Ethernet Types and Protocol Number .....	144
Table 45 Common IP Ports .....	145
Table 46 Policy .....	150
Table 47 Policy: Summary Table .....	152
Table 48 Queuing Method .....	157
Table 49 VLAN Tag Format .....	160
Table 50 Single and Double Tagged 802.11Q Frame Format .....	161
Table 51 802.1Q Frame .....	161
Table 52 VLAN Stacking .....	162
Table 53 Multicast Status .....	166
Table 54 Multicast Setting .....	167
Table 55 Multicast: IGMP Filtering Profile .....	169
Table 56 MVR .....	172
Table 57 MVR: Group Configuration .....	174
Table 58 DHCP Relay .....	180
Table 59 Static Routing .....	181
Table 60 Static Routing .....	184
Table 61 Static Routing .....	185
Table 62 Maintenance .....	187
Table 63 Filename Conventions .....	191
Table 64 General Commands for GUI-based FTP Clients .....	193
Table 65 Access Control Overview .....	195
Table 66 SNMP Commands .....	196
Table 67 SNMP Traps .....	197
Table 68 Access Control: SNMP .....	198
Table 69 Access Control: Logins .....	199
Table 70 Access Control: Service Access Control .....	206
Table 71 Access Control: Remote Management .....	207
Table 72 Diagnostic .....	209
Table 73 Syslog Severity Levels .....	211
Table 74 Syslog .....	212
Table 75 Syslog: Server Setup .....	213
Table 76 ZyXEL Clustering Management Specifications .....	215
Table 77 Cluster Management: Status .....	217
Table 78 FTP Upload to Cluster Member Example .....	219
Table 79 Clustering Management Configuration .....	220
Table 80 MAC Table .....	224
Table 81 ARP Table .....	226

---

Table 82 Configure Clone .....	228
Table 83 Command Interpreter Mode Summary .....	233
Table 84 Command Summary: User Mode .....	237
Table 85 Command Summary: Enable Mode .....	238
Table 86 Command Summary: Configuration Mode .....	243
Table 87 interface port-channel Commands .....	255
Table 88 Command Summary: config-vlan Commands .....	259
Table 89 mvr Commands .....	260
Table 90 Troubleshooting the Start-Up of Your Switch .....	303
Table 91 Troubleshooting Accessing the Switch .....	303
Table 92 Troubleshooting the Password .....	311
Table 93 General Product Specifications .....	313
Table 94 Management Specifications .....	314
Table 95 Physical and Environmental Specifications .....	314
Table 96 Classes of IP Addresses .....	318
Table 97 Allowed IP Address Range By Class .....	318
Table 98 "Natural" Masks .....	319
Table 99 Alternative Subnet Mask Notation .....	319
Table 100 Two Subnets Example .....	320
Table 101 Subnet 1 .....	320
Table 102 Subnet 2 .....	321
Table 103 Subnet 1 .....	321
Table 104 Subnet 2 .....	322
Table 105 Subnet 3 .....	322
Table 106 Subnet 4 .....	322
Table 107 Eight Subnets .....	323
Table 108 Class C Subnet Planning .....	323
Table 109 Class B Subnet Planning .....	324



# Preface

Congratulations on your purchase of the ES-3148 Intelligent Layer 2+ Switch.

This preface introduces you to the ES-3148 and discusses the conventions of this User's Guide. It also provides information on other related documentation.

## About This User's Guide

This manual is designed to guide you through the installation and configuration of your ES-3148 for its various applications.

## Related Documentation

- Web Configurator Online Help

Embedded web help for descriptions of individual screens and supplementary information.









- ZyXEL Web Site

Please go to <http://www.zyxel.com> for product news, firmware, updated documents, and other support materials.

## Syntax Conventions

- “Enter” means for you to type one or more characters. “Select” or “Choose” means for you to use one of the predefined choices.
- Command and arrow keys are enclosed in square brackets. [ENTER] means the Enter, or carriage return key; [ESC] means the Escape key and [SPACE BAR] means the Space Bar.
- Mouse action sequences are denoted using a comma. For example, “In Windows, click **Start**, **Settings** and then **Control Panel**” means first click the **Start** button, then point your mouse pointer to **Settings** and then click **Control Panel**.
- “e.g.,” is a shorthand for “for instance”, and “i.e.,” means “that is” or “in other words”.
- The ES-3148 may be referred to as “the ES-3148”, “the switch”, or “the device” in this User's Guide.
- If a command line takes more one line to write in a description or example, the second line begins with a “->” to indicate that this line is a continuation of the first line.

## Graphics Icons Key

<p>ES-3148</p> 	<p>Computer</p> 	<p>Server</p> 
<p>Computer</p> 	<p>DSLAM</p> 	<p>Gateway</p> 
<p>Central Office/ ISP</p> 	<p>Internet</p> 	<p>Hub/Switch</p> 

## User Guide Feedback

Help us help you. E-mail all User Guide-related comments, questions or suggestions for improvement to [techwriters@zyxel.com.tw](mailto:techwriters@zyxel.com.tw) or send regular mail to The Technical Writing Team, ZyXEL Communications Corp., 6 Innovation Road II, Science-Based Industrial Park, Hsinchu, 300, Taiwan. Thank you.



# CHAPTER 1

## Getting to Know Your Switch

This chapter introduces the main features and applications of the switch.

### 1.1 Introduction

The ES-3148 is a stand-alone layer 2+ Ethernet switch with 48 10/100Mbps ports, two RJ-45 Gigabit ports for stacking and 2 dual personality interfaces for uplink as well as a console port and a management port for local management. A dual personality interface includes one Gigabit port and one slot for mini-GBIC transceiver (SFP module) with one port active at a time.

With its built-in web configurator, managing and configuring the switch is easy. In addition, the switch can also be managed via Telnet, any terminal emulator program on the console port, or third-party SNMP management.

### 1.2 Software Features

This section describes the general software features of the switch.

#### **DHCP Client**

DHCP (Dynamic Host Configuration Protocol RFC 2131 and RFC 2132) allows individual computers to obtain TCP/IP configuration at start-up from a server. You can configure the switch as a DHCP client to obtain TCP/IP information (such as the IP address and subnet mask) from a DHCP server. If you disable the DHCP service, you must manually enter the TCP/IP information.

#### **VLAN**

A VLAN (Virtual Local Area Network) allows a physical network to be partitioned into multiple logical networks. Devices on a logical network belong to one group. A device can belong to more than one group. With VLAN, a device cannot directly talk to or hear from devices that are not in the same group(s); the traffic must first go through a router.

## Queuing

Queuing is used to help solve performance degradation when there is network congestion. Three scheduling services are supported: Strict Priority Queuing (SPQ), Weighted Round Robin (WRR) and Weighted Fair Schedule (WFS). This allows the switch to maintain separate queues for packets from each individual source or flow and prevent a source from monopolizing the bandwidth.

## Port Mirroring

Port mirroring allows you to copy traffic going from one or all ports to another or all ports in order that you can examine the traffic from the mirror port (the port you copy the traffic to) without interference.

## Static Route

Static routes tell the switch how to forward IP traffic when you configure the TCP/IP parameters manually.

## IGMP Snooping

The switch supports IGMP snooping enabling group multicast traffic to be only forwarded to ports that are members of that group; thus allowing you to significantly reduce multicast traffic passing through your switch.

## Multicast VLAN Registration (MVR)

Multicast VLAN Registration (MVR) is designed for applications (such as Media-on-Demand (MoD)) using multicast traffic across a network. MVR allows one single multicast VLAN to be shared among different subscriber VLANs on the network.

This improves bandwidth utilization by reducing multicast traffic in the subscriber VLANs and simplifies multicast group management.

## STP (Spanning Tree Protocol) / RSTP (Rapid STP)

(R)STP detects and breaks network loops and provides backup links between switches, bridges or routers. It allows a switch to interact with other (R)STP -compliant switches in your network to ensure that only one path exists between any two stations on the network.

The switch allows you to create multiple STP configurations and assign ports to a specific tree.

## Link Aggregation

Link aggregation (trunking) is the grouping of physical ports into one logical higher-capacity link. You may want to trunk ports if for example, it is cheaper to use multiple lower-speed links than to under-utilize a high-speed, but more costly, single-port link.

## Port Authentication and Security

For security, the switch allows authentication using IEEE 802.1x with an external RADIUS server and port security that allows only packets with dynamically learned MAC addresses and/or configured static MAC addresses to pass through a port on the switch.

## VLAN Stacking

Use VLAN stacking to add an outer VLAN tag to the inner IEEE 802.1Q tagged frames that enter the network. By tagging the tagged frames (“double-tagged” frames), the service provider can manage up to 4,094 VLAN groups with each group containing up to 4,094 customer VLANs. This allows a service provider to provide different service, based on specific VLANs, for many different customers.

## Differentiated Services (DiffServ)

With DiffServ, the switch marks packets so that they receive specific per-hop treatment at DiffServ-compliant network devices along the route based on the application types and traffic flow.

## Classifier and Policy

You can create a policy to define actions to be performed on a traffic flow grouped by a classifier according to specific criteria such as the IP address, port number or protocol type, etc.

## Cluster Management

Cluster Management allows you to manage switches through one switch, called the cluster manager. The switches must be directly connected and be in the same VLAN group so as to be able to communicate with one another using same cluster management implementation.

## Maintenance and Management Features

- Access Control

You can specify the service(s) and computer IP address(es) to control access to the switch for management.

- Cluster Management

Cluster management (also known as iStacking) allows you to manage switches through one switch, called the cluster manager. The switches must be directly connected and be in the same VLAN group so as to be able to communicate with one another.

- Configuration and Firmware Maintenance

You can backup or restore the switch configuration or upgrade the firmware on the switch.

## IP Protocols

- IP Host (No routing)
- Telnet for configuration and monitoring
- SNMP for management
  - SNMP MIB II (RFC 1213)
  - SNMP v1 RFC 1157
  - SNMPv2, SNMPv2c or later version, compliant with RFC 2011  
SNMPv2 MIB for IP, RFC 2012 SNMPv2 MIB for TCP, RFC 2013  
SNMPv2 MIB for UDP
  - Ethernet MIBs RFC 1643
  - Bridge MIBs RFC 1493
  - SMI RFC 1155
  - RMON RFC 1757
  - SNMPv2, SNMPv2c RFC 2674

## System Monitoring

- System status (link status, rates, statistics counters)
- SNMP
- Temperatures, voltage, fan speed reports and alarms
- Port Mirroring allows you to analyze one port's traffic from another.

## Security

- System management password protection
- Port-based VLAN
- IEEE 802.1Q VLAN
- 802.1x Authentication
- Limit dynamic port MAC address learning
- Static MAC address filtering

## Bandwidth Control

- The ES-3148 supports rate limiting in 64 Kbps increments allowing you to create different service plans.
- The ES-3148 supports IGMP snooping enabling group multicast traffic to be only forwarded to ports that are members of that group; thus allowing you to significantly reduce multicast traffic passing through your switch.
- Broadcast storm control

## Quality of Service

- Eight queues so you can ensure mission-critical data gets delivered on time.
- Follows the IEEE 802.1p priority setting standard based on source/destination MAC addresses.

## 1.3 Hardware Features

This section describes the hardware features of the ES-3148.

### **48 10/100 Mbps Fast Ethernet Ports**

Connect up to 48 computers or switches to the 10/100 Mbps auto-negotiating, automatic cable sensing (auto-MDIX) Ethernet RJ-45 ports.

### **Mini-GBIC Slots**

Install SPF transceivers in these slots to connect to other Ethernet switches at longer distances than the Ethernet port.

### **Gigabit Ethernet Ports**

These ports allow the switch to connect to another WAN switch or daisy-chain to other switches.

### **Management Port**

Connect a computer to this port for management purposes. You cannot access the network through this port.

### **Console Port**

Use the console port for local management of the switch.

### **Backup Power Supply Port**

Connect a backup power supply device to this port to ensure uninterrupted network connection in the event of a power failure.

### **Fans**

The fans cool the switch sufficiently to allow reliable operation of the switch in even poorly ventilated rooms or basements.

### **Power**

The ES-3148 requires 100~240VAC/1.5A power.

## 1.4 Applications

This section shows a few examples of using the switch in various network environments.

## 1.4.1 Backbone Application

In this application, the switch is an ideal solution for small networks where rapid growth can be expected in the near future.

The switch can be used standalone for a group of heavy traffic users. You can connect computers directly to the switch's port or connect other switches to the switch.

In this example, all computers can share high-speed applications on the server. To expand the network, simply add more networking devices such as switches, routers, computers, print servers etc.

**Figure 1** Backbone Application

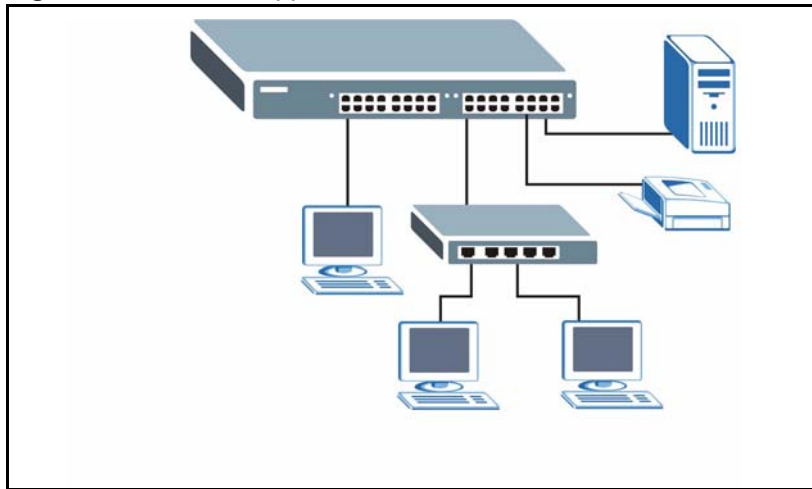

## 1.4.2 Bridging Example

In this example application the switch connects different company departments (**RD** and **Sales**) to the corporate backbone. It can alleviate bandwidth contention and eliminate server and network bottlenecks. All users that need high bandwidth can connect to high-speed department servers via the switch. You can provide a super-fast uplink connection by using a Gigabit Ethernet/mini-GBIC port on the switch.

Moreover, the switch eases supervision and maintenance by allowing network managers to centralize multiple servers at a single location.

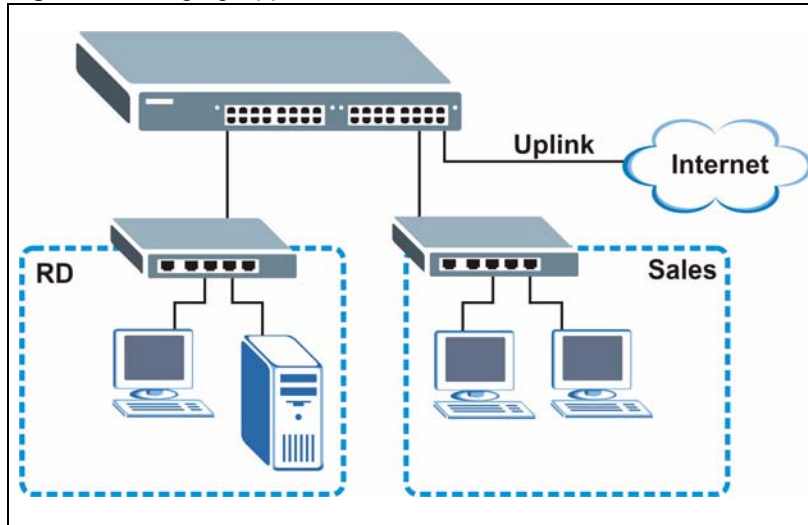
**Figure 2** Bridging Application

### 1.4.3 High Performance Switched Example

The switch is ideal for connecting two networks that need high bandwidth. In the following example, use trunking to connect these two networks.

Switching to higher-speed LANs such as ATM (Asynchronous Transmission Mode) is not feasible for most people due to the expense of replacing all existing Ethernet cables and adapter cards, restructuring your network and complex maintenance. The switch can provide the same bandwidth as ATM at much lower cost while still being able to use existing adapters and switches. Moreover, the current LAN structure can be retained as all ports can freely communicate with each other.

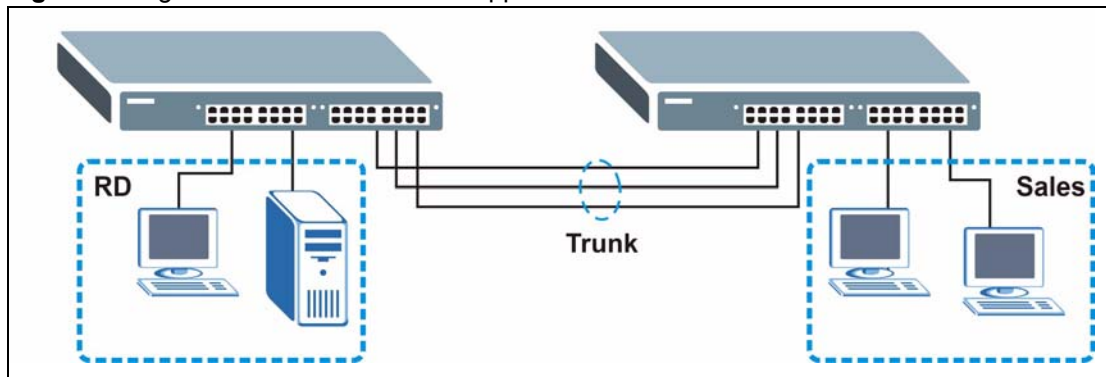
**Figure 3** High Performance Switched Application

### 1.4.4 IEEE 802.1Q VLAN Application Examples

This section shows a workgroup and a shared server example using 802.1Q tagged VLANs.

A VLAN (Virtual Local Area Network) allows a physical network to be partitioned into multiple logical networks. Stations on a logical network belong to one group. A station can belong to more than one group. With VLAN, a station cannot directly talk to or hear from stations that are not in the same group(s) unless such traffic first goes through a router.

For more information on VLANs, refer to [Chapter 8 on page 87](#).

#### 1.4.4.1 Tag-based VLAN Example

Ports in the same VLAN group share the same frame broadcast domain thus increase network performance through reduced broadcast traffic. VLAN groups can be modified at any time by adding, moving or changing ports without any re-cabling.

**Figure 4** Tag-based VLAN Application

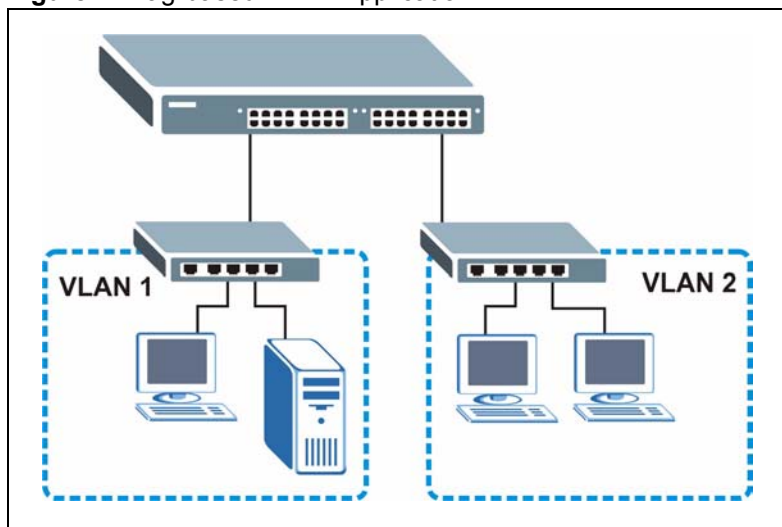

#### 1.4.4.2 VLAN Shared Server Example

Shared resources such as a server can be used by all ports in the same VLAN as the server, as shown in the following example. In this example, only ports that need access to the server need belong to VLAN 1. Ports can belong to other VLAN groups too.

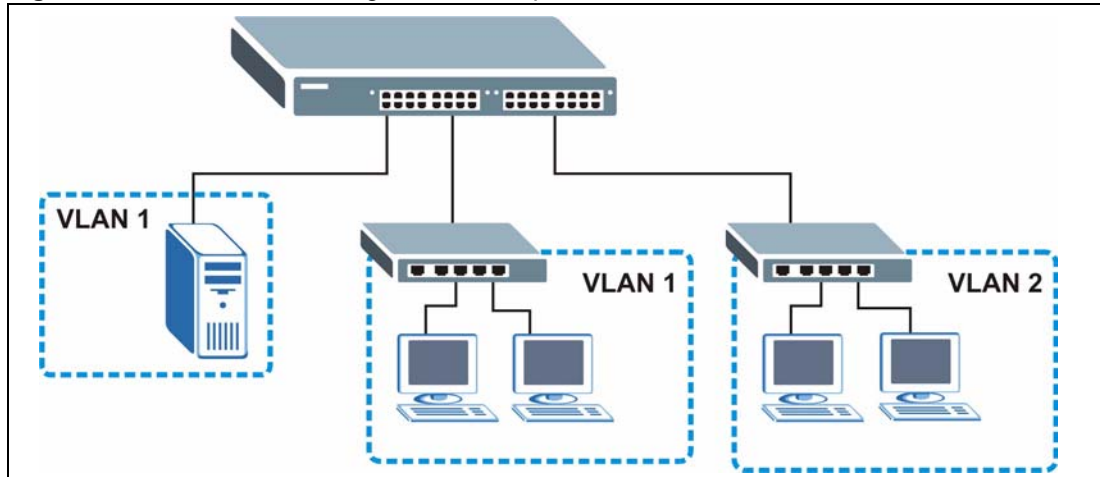

**Figure 5** Shared Server Using VLAN Example



# CHAPTER 2

## Hardware Installation and Connection

This chapter shows you how to install and connect the switch.

### 2.1 Freestanding Installation

- 1 Make sure the switch is clean and dry.
- 2 Set the switch on a smooth, level surface strong enough to support the weight of the switch and the connected cables. Make sure there is a power outlet nearby.
- 3 Make sure there is enough clearance around the switch to allow air circulation and the attachment of cables and the power cord.
- 4 Remove the adhesive backing from the rubber feet.
- 5 Attach the rubber feet to each corner on the bottom of the switch. These rubber feet help protect the switch from shock or vibration and ensure space between devices when stacking.

**Figure 6** Attaching Rubber Feet

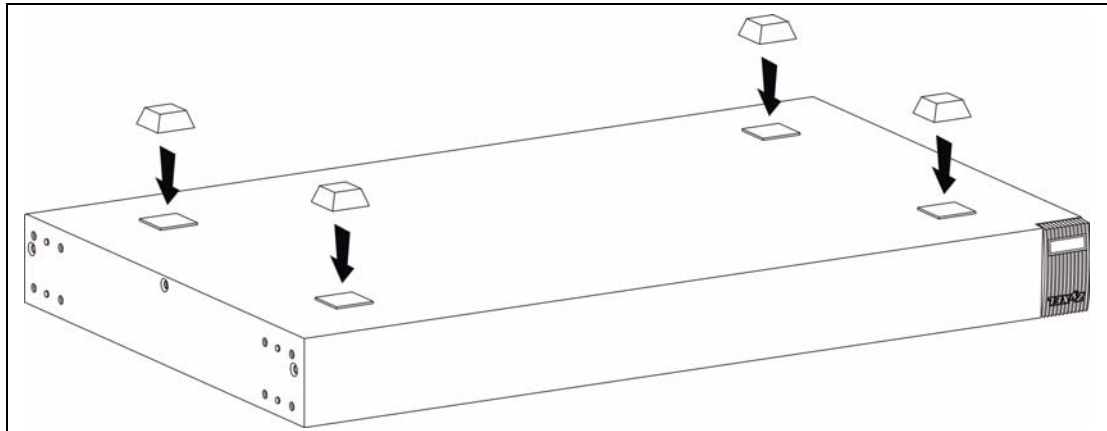

**Note:** Do NOT block the ventilation holes. Leave space between devices when stacking.

For proper ventilation, allow at least 4 inches (10 cm) of clearance at the front and 3.4 inches (8 cm) at the back of the switch. This is especially important for enclosed rack installations.

## 2.2 Mounting the Switch on a Rack

This section lists the rack mounting requirements and precautions and describes the installation steps.

### 2.2.1 Rack-mounted Installation Requirements

- Two mounting brackets.
- Eight M3 flat head screws and a #2 Philips screwdriver.
- Four M5 flat head screws and a #2 Philips screwdriver.

**Note:** Failure to use the proper screws may damage the unit.

#### 2.2.1.1 Precautions

- Make sure the rack will safely support the combined weight of all the equipment it contains.
- Make sure the position of the switch does not make the rack unstable or top-heavy. Take all necessary precautions to anchor the rack securely before installing the unit.

### 2.2.2 Attaching the Mounting Brackets to the Switch

- 1 Position a mounting bracket on one side of the switch, lining up the four screw holes on the bracket with the screw holes on the side of the switch.

**Figure 7** Attaching the Mounting Brackets

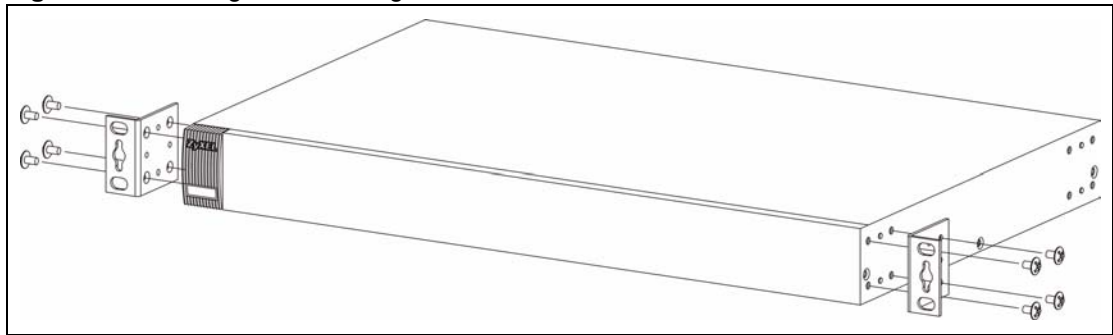

- 2 Using a #2 Philips screwdriver, install the M3 flat head screws through the mounting bracket holes into the switch.
- 3 Repeat steps 1 and 2 to install the second mounting bracket on the other side of the switch.
- 4 You may now mount the switch on a rack. Proceed to the next section.

### 2.2.3 Mounting the Switch on a Rack

- 1 Position a mounting bracket (that is already attached to the switch) on one side of the rack, lining up the two screw holes on the bracket with the screw holes on the side of the rack.

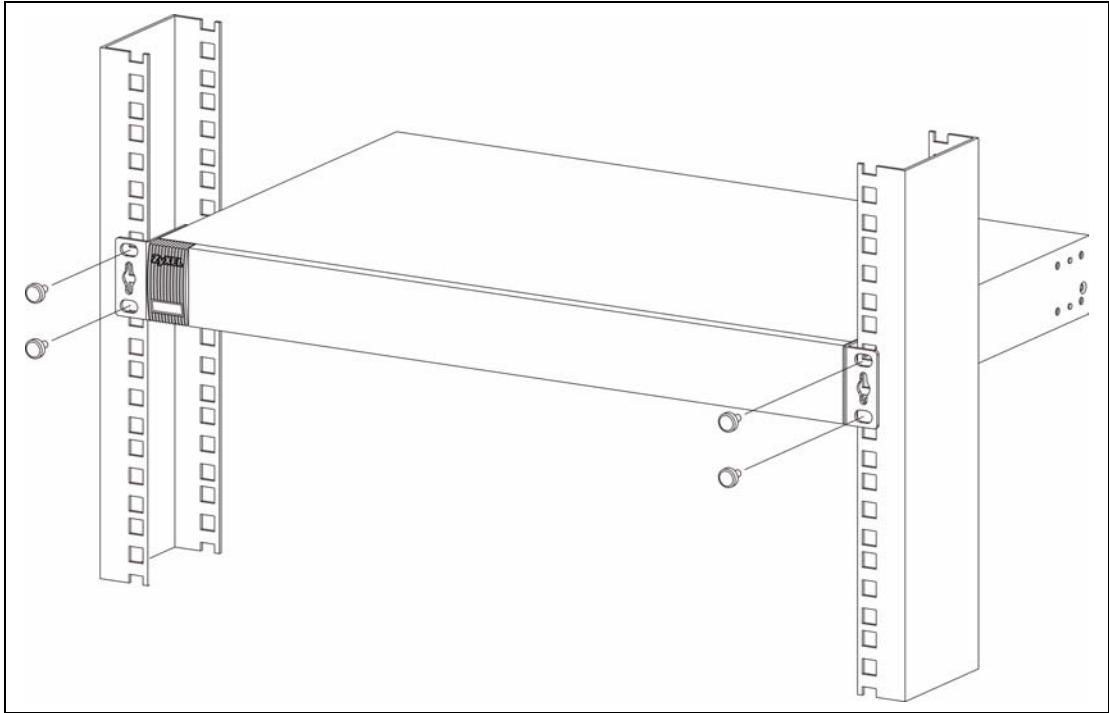
**Figure 8** Mounting the Switch on a Rack

- 2** Using a #2 Philips screwdriver, install the M5 flat head screws through the mounting bracket holes into the rack.
- 3** Repeat steps [1](#) and [2](#) to attach the second mounting bracket on the other side of the rack.



# CHAPTER 3

## Hardware Overview

This chapter describes the front panel and rear panel of the switch and shows you how to make the hardware connections.

### 3.1 Panel Connections

The figure below shows the front panel of the switch.

**Figure 9** Front Panel

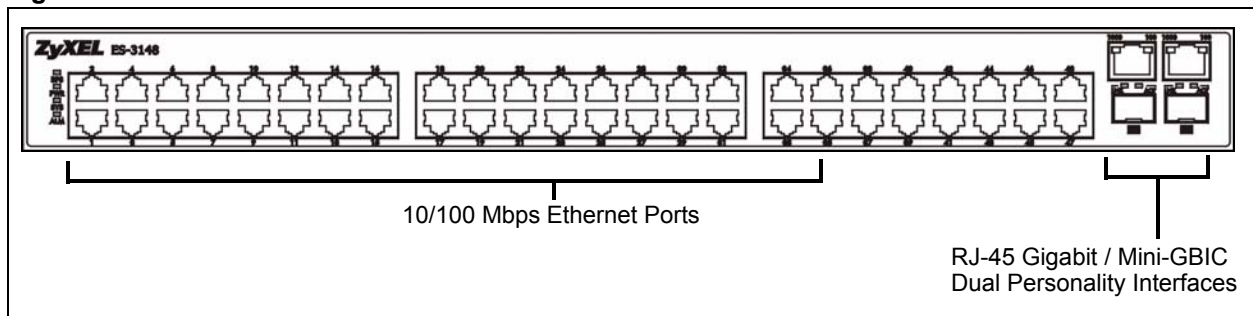

The following table describes the ports on the panels.

**Table 1** Front Panel

CONNECTOR	DESCRIPTION
48 10/100 Mbps RJ-45 Ethernet Ports	Connect these ports to a computer, a hub, an Ethernet switch or router.
Two Dual Personality Interfaces	Each interface has one 1000 Base-T copper RJ-45 port and one Small Form-Factor Pluggable (SFP) fiber port, with one port active at a time.
2 100/1000 Mbps RJ-45 Gigabit Ports	Connect these Gigabit Ethernet ports to high-bandwidth backbone network Ethernet switches.
Mini-GBIC Ports	Use mini-GBIC transceivers in these slots for fiber-optic connections to backbone Ethernet switches.

#### 3.1.1 Ethernet Ports

The switch has 48 10/100Mbps auto-negotiating, auto-crossover Ethernet ports. In 10/100Mbps Fast Ethernet, the speed can be 10Mbps or 100Mbps and the duplex mode can be half duplex or full duplex.

There are two pairs of Gigabit Ethernet/mini-GBIC ports. The mini-GBIC ports have priority over the Gigabit ports. This means that if a mini-GBIC port and the corresponding Gigabit port are connected at the same time, the Gigabit port will be disabled. The speed of the Gigabit Ethernet/mini-GBIC ports can be 100Mbps or 1000Mbps and the duplex mode can be half duplex (at 100 Mbps) or full duplex.

An auto-negotiating port can detect and adjust to the optimum Ethernet speed and duplex mode (full duplex or half duplex) of the connected device.

An auto-crossover (auto-MDI/MDI-X) port automatically works with a straight-through or crossover Ethernet cable.

### 3.1.1.1 Default Ethernet Settings

The factory default negotiation settings for the Ethernet ports on the switch are:

- Speed: Auto
- Duplex: Auto
- Flow control: Off

### 3.1.2 Mini-GBIC Slots

These are slots for mini-GBIC (Gigabit Interface Converter) transceivers. A transceiver is a single unit that houses a transmitter and a receiver. The switch does not come with transceivers. You must use transceivers that comply with the SFP Transceiver MultiSource Agreement (MSA). See the SFF committee's INF-8074i specification Rev 1.0 for details.

There are two pairs of Gigabit Ethernet/mini-GBIC ports. The mini-GBIC ports have priority over the Gigabit ports. This means that if a mini-GBIC port and the corresponding Gigabit port are connected at the same time, the Gigabit port will be disabled.

You can change transceivers while the switch is operating. You can use different transceivers to connect to Ethernet switches with different types of fiber-optic connectors.

- Type: SFP connection interface
- Connection speed: 1 Gigabit per second (Gbps)

**Note:** To avoid possible eye injury, do not look into an operating fiber-optic module's connectors.

#### 3.1.2.1 Transceiver Installation

Use the following steps to install a mini GBIC transceiver (SFP module).

- 1 Insert the transceiver into the slot with the exposed section of PCB board facing down.

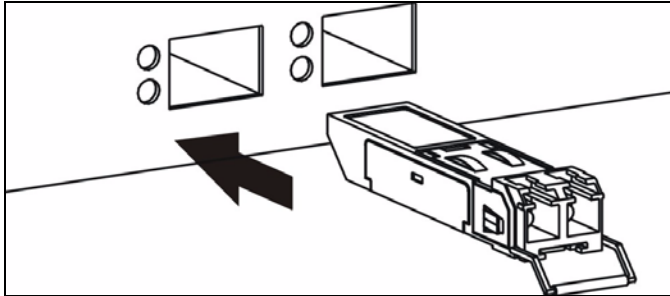

**Figure 10** Transceiver Installation Example

- 2 Press the transceiver firmly until it clicks into place.
- 3 The switch automatically detects the installed transceiver. Check the LEDs to verify that it is functioning properly.

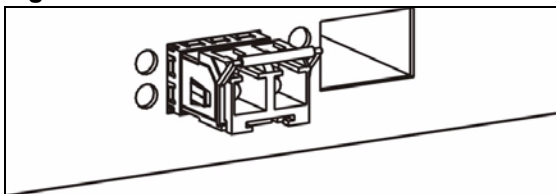
**Figure 11** Installed Transceiver

### 3.1.2.2 Transceiver Removal

Use the following steps to remove a mini GBIC transceiver (SFP module).

- 1 Open the transceiver's latch (latch styles vary).

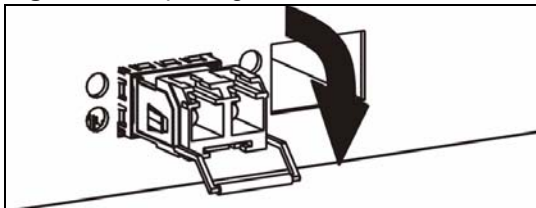
**Figure 12** Opening the Transceiver's Latch Example

- 2 Pull the transceiver out of the slot.

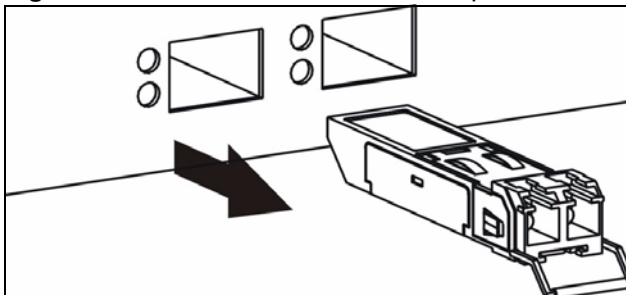
**Figure 13** Transceiver Removal Example

## 3.2 Rear Panel

The following figure shows the rear panel of the ES-3148.

**Figure 14** Rear Panel

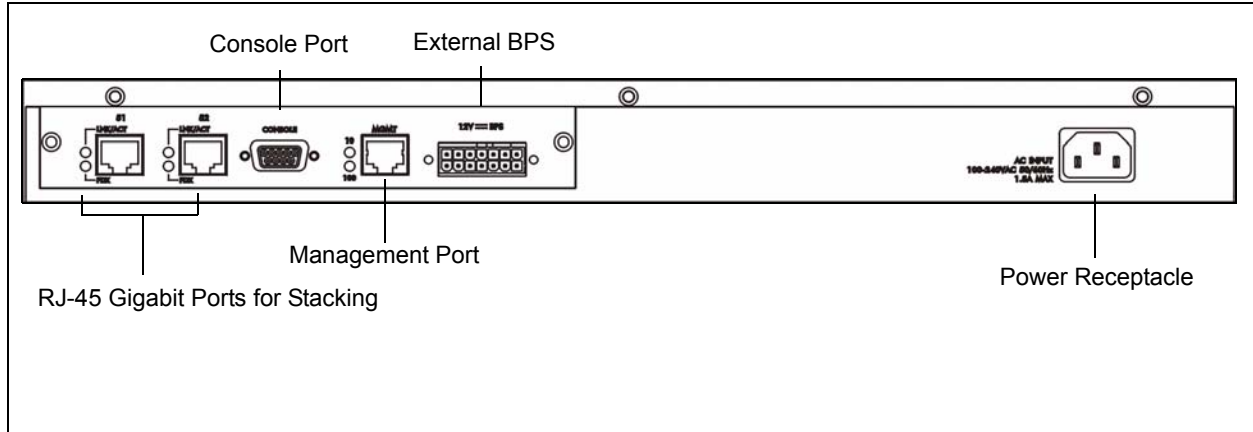

The following table describes the ports on the panels.

**Table 2** Rear Panel

CONNECTOR	DESCRIPTION
2 100/1000 Mbps RJ-45 Gigabit Ports	Connect these Gigabit Ethernet ports to high-bandwidth backbone network Ethernet switches or use them to daisy-chain other switches.
Console Port	Only connect this port if you want to configure the switch using the command line interface (CLI) via the console port. See <a href="#">Section 3.2.1 on page 50</a> .
Management Port	Connect to a computer using an RJ-45 Ethernet cable for local configuration of the switch.
External Backup Power Supply (BPS)	Connect this to an external BPS. See <a href="#">Section 3.2.2 on page 51</a> .
Power Receptacle	Connect this to an appropriate power supply. See <a href="#">Section 3.2.3 on page 51</a> .

### 3.2.1 Console Port

For local management, you can use a computer with terminal emulation software configured to the following parameters:

- VT100 terminal emulation
- 9600 bps
- No parity, 8 data bits, 1 stop bit
- No flow control

Connect the male 9-pin end of the console cable to the console port of the switch. Connect the female end to a serial port (COM1, COM2 or other COM port) of your computer.

## 3.2.2 External Backup Power Supply Connector

The switch supports external backup power supply (BPS).

The backup power supply constantly monitors the status of the internal power supply. The backup power supply automatically provides power to the switch in the event of a power failure. Once the switch receives power from the backup power supply, it will not automatically switch back to using the internal power supply even when the power is resumed.

## 3.2.3 Power Connector

Make sure you are using the correct power source as shown on the panel.

To connect the power to the switch, insert the female end of power cord to the power receptacle on the rear panel. Connect the other end of the supplied power cord to the power source. Make sure that no objects obstruct the airflow of the fans.

## 3.3 LEDs

The following table describes the LEDs on the device.

**Table 3** LEDs

LED	COLOR	STATUS	DESCRIPTION
BPS	Green	Blinking	The system is receiving power from the backup power supply.
		On	The backup power supply is connected and active.
		Off	The backup power supply is not ready or not active.
PWR	Green	On	The system is turned on.
		Off	The system is off.
SYS	Green	Blinking	The system is rebooting and performing self-diagnostic tests.
		On	The system is on and functioning properly.
		Off	The power is off or the system is not ready/malfunctioning.
ALM	Red	On	There is a hardware failure.
		Off	The system is functioning normally.
10/100 Mbps Ethernet Port			
LNK/ACT	Green	Blinking	The system is transmitting/receiving to/from a 10 Mbps Ethernet network.
		On	The link to a 10 Mbps Ethernet network is up.
	Amber	Blinking	The system is transmitting/receiving to/from a 100 Mbps Ethernet network.
		On	The link to a 100 Mbps Ethernet network is up.
		Off	The link to an Ethernet network is down or not connected.
Dual Personality Interface			

**Table 3** LEDs (continued)

LED	COLOR	STATUS	DESCRIPTION
LNK/ACT	Green	Blinking	The system is transmitting/receiving to/from a 10 Mbps or a 1000 Mbps Ethernet network.
		On	The link to a 10 Mbps or a 1000 Mbps Ethernet network is up.
	Amber	Blinking	The system is transmitting/receiving to/from a 100 Mbps Ethernet network.
		On	The link to a 100 Mbps Ethernet network is up.
		Off	The link to an Ethernet network is down or not connected.
LNK	Green	On	The port has a successful connection.
		Off	No Ethernet device is connected to this port.
ACT	Green	Blinking	The port is receiving or transmitting data.
Gigabit Port			
LNK/ACT	Green	Blinking	The system is transmitting/receiving to/from a 10 Mbps or a 1000 Mbps Ethernet network.
		On	The link to a 10 Mbps or a 1000 Mbps Ethernet network is up.
	Amber	Blinking	The system is transmitting/receiving to/from a 100 Mbps Ethernet network.
		On	The link to a 100 Mbps Ethernet network is up.
		Off	The link to an Ethernet network is down.
FDX	Amber	On	The Gigabit port is negotiating in full-duplex mode.
		Off	The Gigabit port is negotiating in half-duplex mode and no collisions are occurring.
MGMT			
10	Green	Blinking	The system is transmitting/receiving to/from an Ethernet device.
		On	The port is connected at 10 Mbps.
		Off	The port is not connected at 10 Mbps or to an Ethernet device.
100	Amber	Blinking	The system is transmitting/receiving to/from an Ethernet device.
		On	The port is connected at 100 Mbps.
		Off	The port is not connected at 100 Mbps or to an Ethernet device.

# CHAPTER 4

## The Web Configurator

This section introduces the configuration and functions of the web configurator.

### 4.1 Introduction

The web configurator is an HTML-based management interface that allows easy switch setup and management via Internet browser. Use Internet Explorer 6.0 and later or Netscape Navigator 7.0 and later versions. The recommended screen resolution is 1024 by 768 pixels.

In order to use the web configurator you need to allow:

- Web browser pop-up windows from your device. Web pop-up blocking is enabled by default in Windows XP SP (Service Pack) 2.
- JavaScript (enabled by default).
- Java permissions (enabled by default).

### 4.2 System Login

- 1 Start your web browser.
- 2 Type “http://” and the IP address of the switch (for example, the default for the management port is 192.168.0.1 and for the switch port is 192.168.1.1) in the **Location** or **Address** field. Press [ENTER].
- 3 The login screen appears. The default username is **admin** and associated default password is **1234**. The date and time display as shown if you have not configured a time server nor manually entered a time and date in the **General Setup** screen.

**Figure 15** Web Configurator: Login



The screenshot shows a dialog box titled "Enter Network Password". It contains the following elements:

- A key icon and the text: "Please type your user name and password."
- Site: 192.168.1.1
- Realm: ES-3148 at Thu Jan 1 03:46:14 1970
- Two input fields: "User Name" and "Password".
- A checkbox labeled "Save this password in your password list" which is currently unchecked.
- Two buttons: "OK" and "Cancel".

4 Click **OK** to view the first web configurator screen.

## 4.3 The Status Screen

The **Status** screen is the first screen that displays when you access the web configurator.

The following figure shows the navigating components of a web configurator screen.

**Figure 16** Web Configurator Home Screen (Status)

The screenshot shows the ZyXEL web configurator interface. At the top left is the ZyXEL logo. Below it is a 'MENU' dropdown with options: Basic Setting, Advanced Application, IP Application, and Management. A yellow circle labeled 'A' highlights this menu. At the top right are four buttons: Save, Status, Logout, and Help, each in a yellow circle labeled B, C, D, and E respectively. The main content area is titled 'Port Status' and contains a table with columns: Port, Name, Link, State, LACP, TxPkts, RxPkts, Errors, InKB/s, OutKB/s, and Up Time. The table lists 20 ports, with port 2 being the only one in a 'FORWARDING' state. Below the table is a filter section with radio buttons for 'Any' and 'Port', and a 'Clear Counter' button. A copyright notice at the bottom right reads '© Copyright 1995-2006 by ZyXEL Communications Corp.'

Port	Name	Link	State	LACP	TxPkts	RxPkts	Errors	InKB/s	OutKB/s	Up Time
1		Down	STOP	Disabled	0	0	0	0.0	0.0	0:00:00
2	100MF		FORWARDING	Disabled	24	176	0	0.0	0.0	0:01:55
3		Down	STOP	Disabled	0	0	0	0.0	0.0	0:00:00
4		Down	STOP	Disabled	0	0	0	0.0	0.0	0:00:00
5		Down	STOP	Disabled	0	0	0	0.0	0.0	0:00:00
6		Down	STOP	Disabled	0	0	0	0.0	0.0	0:00:00
7		Down	STOP	Disabled	0	0	0	0.0	0.0	0:00:00
8		Down	STOP	Disabled	0	0	0	0.0	0.0	0:00:00
9		Down	STOP	Disabled	0	0	0	0.0	0.0	0:00:00
10		Down	STOP	Disabled	0	0	0	0.0	0.0	0:00:00
11		Down	STOP	Disabled	0	0	0	0.0	0.0	0:00:00
12		Down	STOP	Disabled	0	0	0	0.0	0.0	0:00:00
13		Down	STOP	Disabled	0	0	0	0.0	0.0	0:00:00
14		Down	STOP	Disabled	0	0	0	0.0	0.0	0:00:00
15		Down	STOP	Disabled	0	0	0	0.0	0.0	0:00:00
16		Down	STOP	Disabled	0	0	0	0.0	0.0	0:00:00
17		Down	STOP	Disabled	0	0	0	0.0	0.0	0:00:00
18		Down	STOP	Disabled	0	0	0	0.0	0.0	0:00:00
19		Down	STOP	Disabled	0	0	0	0.0	0.0	0:00:00
20		Down	STOP	Disabled	0	0	0	0.0	0.0	0:00:00

**A** - Click the menu items to open submenu links, and then click on a submenu link to open the screen in the main window.

**B, C, D, E** - These are quick links which allow you to perform certain tasks no matter which screen you are currently working in.

**B** - Click this link to save your configuration into the switch's nonvolatile memory. Nonvolatile memory is the configuration of your switch that stays the same even if the switch's power is turned off.

**C** - Click this link to go to the status page of the switch.



**D** - Click this link to logout of the web configurator.

**E** - Click this link to display web help pages. The help pages provide descriptions for all of the configuration screens.

## 4.4 Menu Overview

In the navigation panel, click a main link to reveal a list of submenu links.

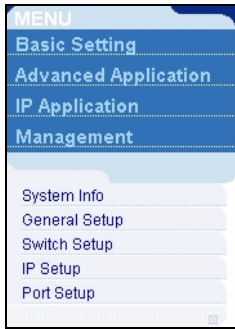
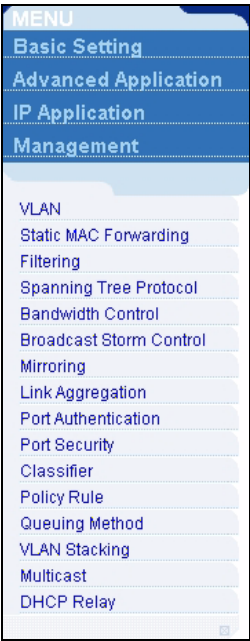
**Table 4** Navigation Panel Sub-links Overview

BASIC SETTING	ADVANCED APPLICATION	ROUTING PROTOCOL	MANAGEMENT
 <p>MENU</p> <ul style="list-style-type: none"> <li>Basic Setting</li> <li>Advanced Application</li> <li>IP Application</li> <li>Management</li> </ul> <ul style="list-style-type: none"> <li>System Info</li> <li>General Setup</li> <li>Switch Setup</li> <li>IP Setup</li> <li>Port Setup</li> </ul>	 <p>MENU</p> <ul style="list-style-type: none"> <li>Basic Setting</li> <li>Advanced Application</li> <li>IP Application</li> <li>Management</li> </ul> <ul style="list-style-type: none"> <li>VLAN</li> <li>Static MAC Forwarding</li> <li>Filtering</li> <li>Spanning Tree Protocol</li> <li>Bandwidth Control</li> <li>Broadcast Storm Control</li> <li>Mirroring</li> <li>Link Aggregation</li> <li>Port Authentication</li> <li>Port Security</li> <li>Classifier</li> <li>Policy Rule</li> <li>Queuing Method</li> <li>VLAN Stacking</li> <li>Multicast</li> <li>DHCP Relay</li> </ul>	 <p>MENU</p> <ul style="list-style-type: none"> <li>Basic Setting</li> <li>Advanced Application</li> <li>IP Application</li> <li>Management</li> </ul> <ul style="list-style-type: none"> <li>Static Routing</li> <li>DiffServ</li> </ul>	 <p>MENU</p> <ul style="list-style-type: none"> <li>Basic Setting</li> <li>Advanced Application</li> <li>IP Application</li> <li>Management</li> </ul> <ul style="list-style-type: none"> <li>Maintenance</li> <li>Access Control</li> <li>Diagnostic</li> <li>Syslog</li> <li>Cluster Management</li> <li>MAC Table</li> <li>ARP Table</li> <li>Configure Clone</li> </ul>

The following table lists the various web configurator screens within the sub-links.

**Table 5** Web Configurator Screen Sub-links Details

BASIC SETTING	ADVANCED APPLICATION	ROUTING PROTOCOL	MANAGEMENT
System Info General Setup Switch Setup IP Setup Port Setup	VLAN VLAN Status VLAN Port Setting Protocol Based VLAN Static VLAN Static MAC Forwarding Filtering Spanning Tree Protocol Status Configuration Bandwidth Control Broadcast Storm Control Mirroring Link Aggregation Status Configuration Link Aggregation Status Configuration Port Authentication RADIUS 802.1x Port Security Classifier Policy Rule Queuing Method VLAN Stacking Multicast Multicast Status Multicast Setting IGMP Filtering Profile MVR DHCP Relay	Static Routing DiffServ DiffServ Setting DSCP Setting	Maintenance Firmware Upgrade Restore Configuration Backup Configuration Load Factory Default Reboot System Access Control SNMP Logins Service Access Control Remote Management Diagnostic Syslog Setup Server Setup Cluster Management Status Configuration MAC Table ARP Table Configure Clone



The following table describes the links in the navigation panel.

**Table 6** Navigation Panel Links

LINK	DESCRIPTION
Basic Settings	
System Info	This link takes you to a screen that displays general system and hardware monitoring information.
General Setup	This link takes you to a screen where you can configure general identification information about the switch.
Switch Setup	This link takes you to a screen where you can set up global switch parameters such as VLAN type, MAC address learning, GARP and priority queues.
IP Setup	This link takes you to a screen where you can configure the management IP address, subnet mask (necessary for switch management) and DNS (domain name server).
Port Setup	This link takes you to screens where you can configure settings for individual switch ports.
Advanced Application	
VLAN	This link takes you to screens where you can configure port-based or 802.1Q VLAN (depending on what you configured in the Switch Setup menu).
Static MAC Forwarding	This link takes you to screens where you can configure static MAC addresses for a port. These static MAC addresses do not age out.
Filtering	This link takes you to a screen to set up filtering rules.
Spanning Tree Protocol	This link takes you to screens where you can configure the STP/RSTP to prevent network loops.
Bandwidth Control	This link takes you to screens where you can cap the maximum incoming bandwidth allowed on specified port(s).
Broadcast Storm Control	This link takes you to a screen to set up broadcast filters.
Mirroring	This link takes you to screens where you can copy traffic from one port or ports to another port in order that you can examine the traffic from the first port without interference
Link Aggregation	This link takes you to a screen where you can logically aggregate physical links to form one logical, higher-bandwidth link.
Port Authentication	This link takes you to a screen where you can configure RADIUS (Remote Authentication Dial-In User Service), a protocol for user authentication that allows you to use an external server to validate an unlimited number of users.
Port Security	This link takes you to a screen where you can activate maximum port security through the use of configured static MAC addresses.
Classifier	This link takes you to a screen where you can configure classifiers.
Policy Rule	This link takes you to a screen where you can configure policy rules.
Queuing Method	This link takes you to a screen where you can configure strictly priority or weighted fair scheduling with associated queue weights for each port.
VLAN Stacking	This link takes you to a screen where you can configure VLAN stacking.
Multicast	This link takes you to a screen where you can configure various multicast features and create multicast VLANs.
DHCP Relay	This link takes you to a screen where you can configure DHCP relay information and specify the DHCP server(s).

**Table 6** Navigation Panel Links (continued)

LINK	DESCRIPTION
Routing Protocol	
Static Routing	This link takes you to screens where you can configure static routes. A static route defines how the switch should forward traffic by configuring the TCP/IP parameters manually.
DiffServ	This link takes you to screens where you can configure DiffServ and DSCP settings.
Management	
Maintenance	This link takes you to screens where you can perform firmware and configuration file maintenance as well as reboot the system.
Access Control	This link takes you to screens where you can change the system login password and configure SNMP and remote management.
Diagnostic	This link takes you to screens where you can view system logs and test port(s).
Syslog	This link takes you to screens where you can setup system logs and a system log server.
Cluster Management	This link takes you to a screen where you can configure clustering management and view its status.
MAC Table	This link takes you to a screen where you can view the MAC addresses (and types) of devices attached to what ports and VLAN IDs.
ARP Table	This link takes you to a screen where you can view the MAC addresses – IP address resolution table.
Configure Clone	This link takes you to a screen where you can clone port attributes of a port and transfer them to other port(s).

### 4.4.1 Change Your Password

After you log in for the first time, it is recommended you change the default administrator password. Click **Management**, **Access Control** and then **Logins** to display the next screen.

**Figure 17** Change Administrator Login Password

**Logins** [Access Control](#)

**Administrator**

Old Password

New Password

Retype to confirm

**Please record your new password whenever you change it. The system will lock you out if you have forgotten your password.**

**Edit Logins**

Login	User Name	Password	Retype to confirm
1	<input type="text"/>	<input type="text"/>	<input type="text"/>
2	<input type="text"/>	<input type="text"/>	<input type="text"/>
3	<input type="text"/>	<input type="text"/>	<input type="text"/>
4	<input type="text"/>	<input type="text"/>	<input type="text"/>

## 4.5 Saving Your Configuration

When you are done modifying the settings in a screen, click **Apply** to save your changes back to the run-time memory. Settings in the run-time memory are lost when the ES-3148's power is turned off.

Click the **Save** link in the upper right hand corner of the web configurator to save your configuration to nonvolatile memory. Nonvolatile memory refers to the ES-3148's storage that remains even if the ES-3148's power is turned off.

**Note:** Use the **Save** link when you are done with a configuration session.

## 4.6 Switch Lockout

You could block yourself (and all others) from accessing the switch through the web configurator if you do one of the following:

- 1 Deleting the management VLAN (default is VLAN 1).
- 2 Deleting all port-based VLANs with the CPU port as a member. The "CPU port" is the management port of the switch.
- 3 Filtering all traffic to the CPU port.
- 4 Disabling all ports.
- 5 Misconfiguring the text configuration file.

- 6 Forgetting the password and/or IP address.
- 7 Preventing all services from accessing the switch.
- 8 Changing a service port number but forgetting it.

**Note:** Be careful not to lock yourself and others out of the switch.

Try using the out-of-band management port before resetting the switch. The default IP address is 192.168.0.1.

## 4.7 Resetting the Switch

If you lock yourself (and others) out of the switch, you can try using out-of-band management. If you still cannot correct the situation or forgot the password, you will need to reload the factory-default configuration file.

### 4.7.1 Reload the Configuration File

Uploading the factory-default configuration file replaces the current configuration file with the factory-default configuration file. This means that you will lose all previous configurations and the speed of the console port will be reset to the default of 9600bps with 8 data bit, no parity, one stop bit and flow control set to none. The password will also be reset to “1234” and the IP address to 192.168.1.1.

To upload the configuration file, do the following:

- 1 Connect to the console port using a computer with terminal emulation software. See [Section 3.2.1 on page 50](#) for details.
- 2 Disconnect and reconnect the switch's power to begin a session. When you reconnect the switch's power, you will see the initial screen.
- 3 When you see the message “Press any key to enter Debug Mode within 3 seconds ...” press any key to enter debug mode.
- 4 Type `atlc` after the “Enter Debug Mode” message.
- 5 Wait for the “Starting XMODEM upload” message before activating XMODEM upload on your terminal.
- 6 This is an example Xmodem configuration upload using HyperTerminal. Click **Transfer**, then **Send File** to display the following screen.

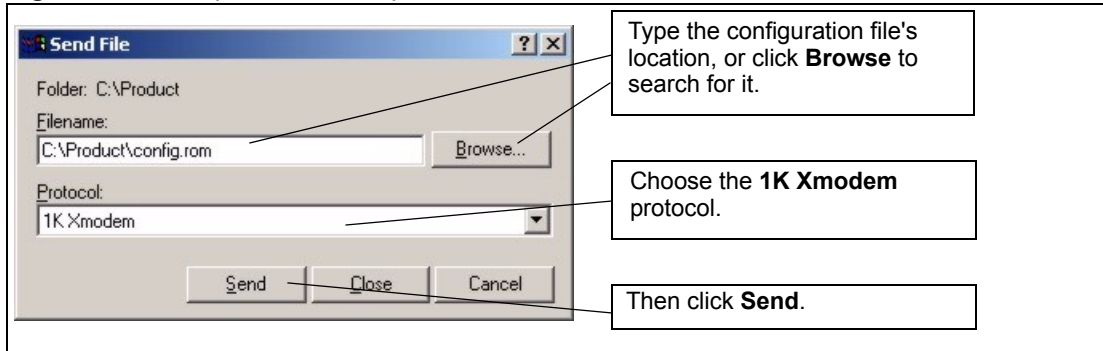
**Figure 18** Example Xmodem Upload

**7** After a configuration file upload, type `atgo` to restart the switch.

**Figure 19** Reload the Configuration file: Via Console Port

```

Bootbase Version: V0.6 | 03/06/2006 09:21:13
RAM:Size = 32 Mbytes
DRAM POST: Testing: 32768K OK
DRAM Test SUCCESS !
FLASH: Intel 32M

ZyNOS Version: 3.70(AID.0)b0 | 4/28/2006 17:27:36

Press any key to enter debug mode within 3 seconds.
.....
Enter Debug Mode

ES-3148> atlc
Starting XMODEM upload (CRC mode)....
CCCCCCCCCCCCCCCC
Total 262144 bytes received.
Erasing..
.....
OK
ES-3148> atgo

```

The switch is now reinitialized with a default configuration file including the default password of "1234".

## 4.7.2 Reset to the Factory Defaults

To reset the switch back to the factory defaults, do the following:

- 1** Connect to the console port using a computer with terminal emulation software. See the chapter on hardware connections for details.
- 2** Disconnect and reconnect the switch's power to begin a session. When you reconnect the switch's power, you will see the initial screen.
- 3** When you see the message "Press any key to enter Debug Mode within 3 seconds" press any key to enter debug mode.

- 4 Type `atbr` after the "Enter Debug Mode" message.

**Figure 20** Resetting the Switch: Via the Console Port

```
Bootbase Version: V0.6 | 03/06/2006 09:21:13
RAM:Size = 32 Mbytes
DRAM POST: Testing: 32768K OK
DRAM Test SUCCESS !
FLASH: Intel 32M

ZyNOS Version: 3.70(AID.0)b0 | 4/28/2006 17:27:36

Press any key to enter debug mode within 3 seconds.
.....
Enter Debug Mode

ES-3148> atbr
Restore default
Romfile.....
.....OK
ES-3148> atgo
```

- 5 After the resetting, type `atgo` to restart the switch.

## 4.8 Logging Out of the Web Configurator

Click **Logout** in a screen to exit the web configurator. You have to log in with your password again after you log out. This is recommended after you finish a management session both for security reasons and so as you don't lock out other switch administrators.

**Figure 21** Web Configurator: Logout Screen

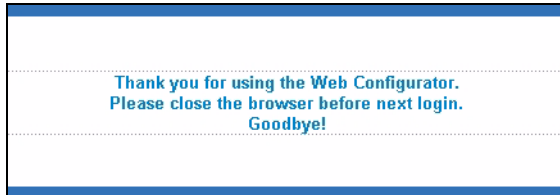

## 4.9 Help

The web configurator's online help has descriptions of individual screens and some supplementary information.

Click the **Help** link from a web configurator screen to view an online help description of that screen.

# CHAPTER 5

## Initial Setup Example

This chapter shows how to set up the switch for an example network.

### 5.1 Overview

The following lists the configuration steps for the initial setup:

- Create a VLAN
- Set port VLAN ID
- Configure the switch IP management address

#### 5.1.1 Creating a VLAN

VLANs confine broadcast frames to the VLAN group in which the port(s) belongs. You can do this with port-based VLAN or tagged static VLAN with fixed port members.

In this example, you want to configure port 1 as a member of VLAN 2.

**Figure 22** Initial Setup Network Example: VLAN

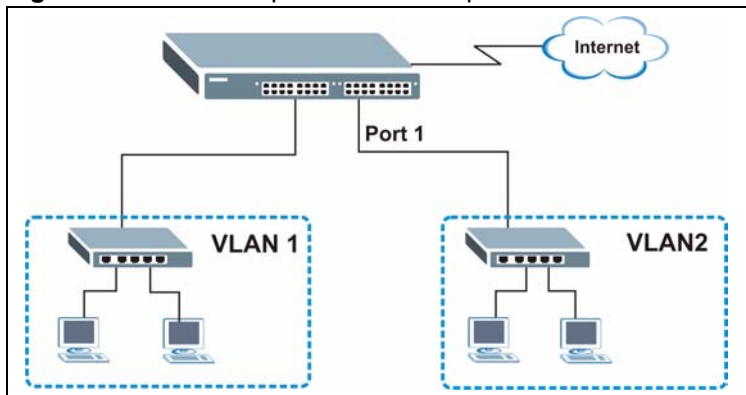

- 1 Click **Advanced Application** and **VLAN** in the navigation panel and click the **Static VLAN** link.

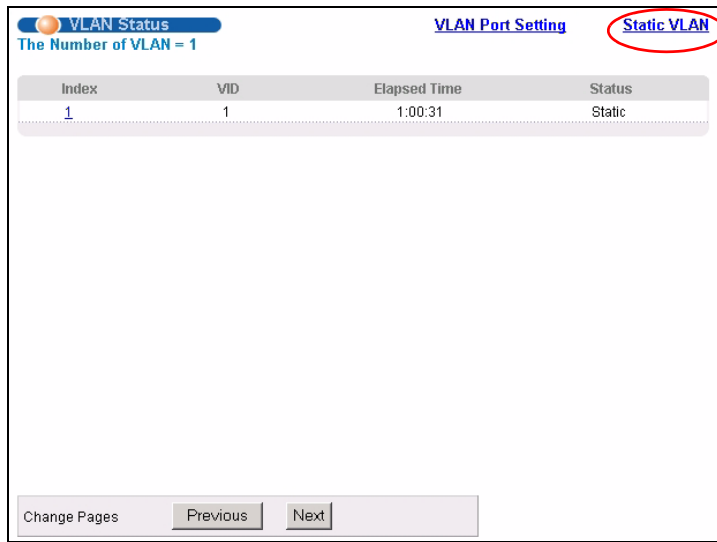

- 2 In the **Static VLAN** screen, select **ACTIVE**, enter a descriptive name in the **Name** field and enter 2 in the **VLAN Group ID** field for the **VLAN2** network.

**Note:** The **VLAN Group ID** field in this screen and the **VID** field in the **IP Setup** screen refer to the same VLAN ID.

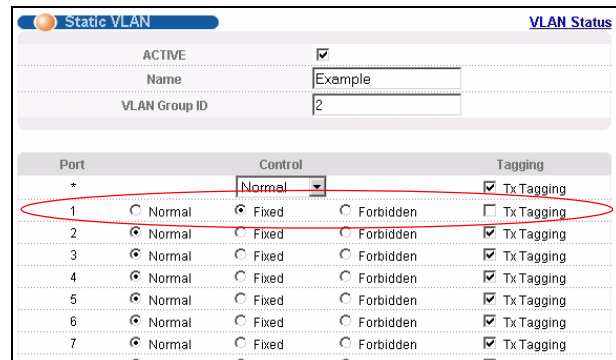

- 3 Since the **VLAN2** network is connected to port 1 on the switch, select **Fixed** to configure port 1 to be a permanent member of the VLAN only.
- 4 To ensure that VLAN-unaware devices (such as computers and hubs) can receive frames properly, clear the **TX Tagging** check box to set the switch to remove VLAN tags before sending.
- 5 Click **Add** to save the settings to the run-time memory. Settings in the run-time memory are lost when the ES-3148's power is turned off.

## 5.1.2 Setting Port VID

Use PVID to add a tag to incoming untagged frames received on that port so that the frames are forwarded to the VLAN group that the tag defines.

In the example network, configure 2 as the port VID on port 1 so that any untagged frames received on that port get sent to VLAN 2.

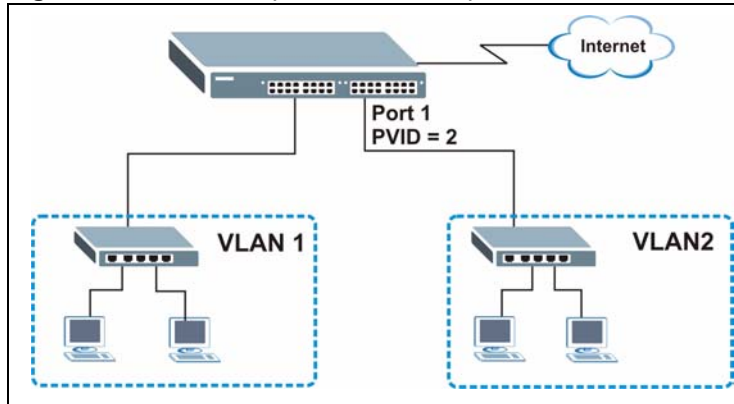

**Figure 23** Initial Setup Network Example: Port VID

- 1 Click **Advanced Applications** and **VLAN** in the navigation panel. Then click the **VLAN Port Setting** link.
- 2 Enter 2 in the **PVID** field for port 1 and click **Apply** to save your changes back to the run-time memory. Settings in the run-time memory are lost when the ES-3148's power is turned off.

VLAN Port Setting					
GVRP		<input type="checkbox"/>	Protocol Based Vlan		VLAN Status
Port isolation		<input type="checkbox"/>			
Port	Ingress Check	PVID	GVRP	Acceptable Frame Type	VLAN Trunking
*	<input type="checkbox"/>		<input type="checkbox"/>	All	<input type="checkbox"/>
1	<input type="checkbox"/>	2	<input type="checkbox"/>	All	<input type="checkbox"/>
2	<input type="checkbox"/>	1	<input type="checkbox"/>	All	<input type="checkbox"/>
3	<input type="checkbox"/>	1	<input type="checkbox"/>	All	<input type="checkbox"/>
4	<input type="checkbox"/>	1	<input type="checkbox"/>	All	<input type="checkbox"/>
5	<input type="checkbox"/>	1	<input type="checkbox"/>	All	<input type="checkbox"/>
6	<input type="checkbox"/>	1	<input type="checkbox"/>	All	<input type="checkbox"/>
7	<input type="checkbox"/>	1	<input type="checkbox"/>	All	<input type="checkbox"/>

## 5.2 Configuring Switch Management IP Address

The default management IP address of the switch is 192.168.1.1. You can configure another IP address in a different subnet for management purposes. The following figure shows an example.

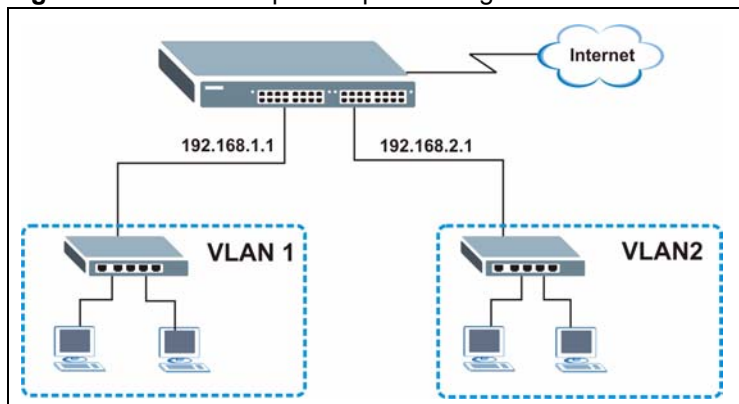
**Figure 24** Initial Setup Example: Management IP Address

- 1 Connect your computer to any Ethernet port on the switch. Make sure your computer is in the same subnet as the switch.
- 2 Open your web browser and enter 192.168.1.1 (the default IP address) in the address bar to access the web configurator. See [Section 4.2 on page 53](#) for more information.

3 Click **Basic Setting** and **IP Setup** in the navigation panel.

4 Configure the related fields in the **IP Setup** screen.

For the **VLAN2** network, enter 192.168.2.1 as the IP address and 255.255.255.0 as the subnet mask.

5 In the **VID** field, enter the ID of the VLAN group to which you want this management IP address to belong. This is the same as the VLAN ID you configure in the **Static VLAN** screen.

6 Select the **Manageable** check box to allow the switch to be managed from the ports belonging to **VLAN2** using this specified IP address.

Click **Add** to save your changes back to the run-time memory. Settings in the run-time memory are lost when the ES-3148's power is turned off.

**IP Setup**

Domain Name Server: 0.0.0.0

Default Management:  In-band  Out-of-band

In-band Management IP Address:  DHCP Client  Static IP Address

Static IP Address:

IP Address	192.168.1.1
IP Subnet Mask	255.255.255.0
Default Gateway	0.0.0.0
VID	1

Out-of-band Management IP Address:

IP Address	192.168.0.1
IP Subnet Mask	255.255.255.0
Default Gateway	0.0.0.0

Apply Cancel

**In-band IP Addresses**

IP Address	192.168.2.1
IP Subnet Mask	255.255.255.0
VID	2
Default Gateway	0.0.0.0
Manageable	<input checked="" type="checkbox"/>

Add Cancel

Index	IP Address	IP Subnet Mask	VID	Default Gateway	Manageable	Delete

Delete Cancel

# CHAPTER 6

## System Status and Port Statistics

This chapter describes the system status (web configurator home page) and port details screens.

### 6.1 Port Status Summary

The home screen of the web configurator displays a port statistical summary table with links to each port showing statistical details.

To view the port statistics, click **Status** in all web configurator screens to display the **Status** screen as shown next.

**Figure 25** Status

Port	Name	Link	State	LACP	TxPkts	RxPkts	Errors	Tx KB/s	Rx KB/s	Up Time
<a href="#">1</a>		Down	STOP	Disabled	0	0	0	0.0	0.0	0:00:00
<a href="#">2</a>	100M/F		FORWARDING	Disabled	77394	94168	0	0.838	0.649	1:10:44
<a href="#">3</a>		Down	STOP	Disabled	0	0	0	0.0	0.0	0:00:00
<a href="#">4</a>	100M/F		FORWARDING	Disabled	92638	75258	0	0.649	0.838	1:10:44
<a href="#">5</a>		Down	STOP	Disabled	0	0	0	0.0	0.0	0:00:00
<a href="#">46</a>		Down	STOP	Disabled	0	0	0	0.0	0.0	0:00:00
<a href="#">47</a>		Down	STOP	Disabled	0	0	0	0.0	0.0	0:00:00
<a href="#">48</a>		Down	STOP	Disabled	0	0	0	0.0	0.0	0:00:00
<a href="#">49</a>		Down	STOP	Disabled	0	0	0	0.0	0.0	0:00:00
<a href="#">50</a>		Down	STOP	Disabled	0	0	0	0.0	0.0	0:00:00
<a href="#">51</a>		Down	STOP	Disabled	0	0	0	0.0	0.0	0:00:00
<a href="#">52</a>		Down	STOP	Disabled	0	0	0	0.0	0.0	0:00:00

Any  
 Port

The following table describes the labels in this screen.

**Table 7** Status

LABEL	DESCRIPTION
Port	This identifies the Ethernet port. Click a port number to display the <b>Port Details</b> screen (refer to <a href="#">Figure 26 on page 69</a> ).
Name	This is the name you assigned to this port in the <b>Basic Setting, Port Setup</b> screen.

**Table 7** Status (continued)

<b>LABEL</b>	<b>DESCRIPTION</b>
Link	This field displays the speed (either <b>10M</b> for 10Mbps, <b>100M</b> for 100Mbps or <b>1000M</b> for 1000Mbps) and the duplex ( <b>F</b> for full duplex or <b>H</b> for half). It also shows the cable type ( <b>Copper</b> or <b>Fiber</b> ) for the combo ports.
State	If STP (Spanning Tree Protocol) is enabled, this field displays the STP state of the port (see <a href="#">Section 11.1.3 on page 108</a> for more information). If STP is disabled, this field displays FORWARDING if the link is up, otherwise, it displays STOP.
LACP	This fields displays whether LACP (Link Aggregation Control Protocol) has been enabled on the port.
TxPkts	This field shows the number of transmitted frames on this port.
RxPkts	This field shows the number of received frames on this port.
Errors	This field shows the number of received errors on this port.
Tx KB/s	This field shows the number of kilobytes per second transmitted on this port.
Rx KB/s	This field shows the number of kilobytes per second received on this port.
Up Time	This field shows the total amount of time in hours, minutes and seconds the port has been up.
Clear Counter	Enter a port number and then click <b>Clear Counter</b> to erase the recorded statistical information for that port, or select <b>Any</b> to clear statistics for all ports.

### 6.1.1 Status: Port Details

Click a number in the **Port** column in the **Status** screen to display individual port statistics. Use this screen to check status and detailed performance data about an individual port on the switch.

**Figure 26** Status: Port Details

Port Details		Port Status
<b>Port Info</b>	Port NO.	11
	Name	
	Link	Down
	Status	FORWARDING
	LACP	Disabled
	TxPkts	684
	RxPkts	477
	Errors	0
	Tx KBs/s	0.0
	Rx KBs/s	0.0
	Up Time	0:07:42
<b>TX Packet</b>	<b>TX Packets</b>	<b>684</b>
	Multicast	1
	Broadcast	0
	Pause	523
	Tagged	0
<b>RX Packet</b>	<b>RX Packets</b>	<b>518</b>
	Multicast	18
	Broadcast	0
	Pause	0
	Control	0
<b>TX Collision</b>	<b>Single</b>	<b>0</b>
	Multiple	827847
	Excessive	0
	Late	0
<b>Error Packet</b>	<b>RX CRC</b>	<b>0</b>
	Length	0
	Runt	0
<b>Distribution</b>	<b>64</b>	<b>519</b>
	65 to 127	38
	128 to 255	59
	256 to 511	135
	512 to 1023	30
	1024 to 1518	522
	Giant	0

The following table describes the labels in this screen.

**Table 8** Status: Port Details

LABEL	DESCRIPTION
Port Info	
Name	This field shows the name of the port.
Link	This field shows whether the Ethernet connection is down, and the speed/duplex mode. It also shows the cable type ( <b>Copper</b> or <b>Fiber</b> ) for the combo ports.
Status	If STP (Spanning Tree Protocol) is enabled, this field displays the STP state of the port (see <a href="#">Section 11.1.3 on page 108</a> for more information). If STP is disabled, this field displays FORWARDING if the link is up, otherwise, it displays STOP.

**Table 8** Status: Port Details (continued)

<b>LABEL</b>	<b>DESCRIPTION</b>
LACP	This field shows if LACP is enabled on this port or not.
TxPkts	This field shows the number of transmitted frames on this port
RxPkts	This field shows the number of received frames on this port
Errors	This field shows the number of received errors on this port.
Tx KB/s	This field shows the number kilobytes per second transmitted on this port.
Rx KB/s	This field shows the number of kilobytes per second received on this port.
Up Time	This field shows the total amount of time the connection has been up.
Tx Packet The following fields display detailed information about packets transmitted.	
TX Packet	This field shows the number of good packets (unicast, multicast and broadcast) transmitted.
Multicast	This field shows the number of good multicast packets transmitted.
Broadcast	This field shows the number of good broadcast packets transmitted.
Pause	This field shows the number of 802.3x Pause packets transmitted.
Tagged	This field shows the number of packets with VLAN tags transmitted.
Rx Packet The following fields display detailed information about packets received.	
RX Packet	This field shows the number of good packets (unicast, multicast and broadcast) received.
Multicast	This field shows the number of good multicast packets received.
Broadcast	This field shows the number of good broadcast packets received.
Pause	This field shows the number of 802.3x Pause packets received.
Control	This field shows the number of control received (including those with CRC error) but it does not include the 802.3x Pause frames.
TX Collision The following fields display information on collisions while transmitting.	
Single	This is a count of successfully transmitted frames for which transmission is inhibited by exactly one collision.
Multiple	This is a count of successfully transmitted frames for which transmission was inhibited by more than one collision.
Excessive	This is a count of frames for which transmission failed due to excessive collisions. Excessive collision is defined as the number of maximum collisions before the retransmission count is reset.
Late	This is the number of times a late collision is detected, that is, after 512 bits of the frame have already been transmitted.
Error Packet	
RX CRC	This field shows the number of packets received with CRC (Cyclic Redundant Check) error(s).
Length	This field shows the number of frames received with a length that was out of range.
Runt	This field shows the number of packets received that were too short (shorter than 64 octets), including the ones with CRC errors.
Distribution	

**Table 8** Status: Port Details (continued)

LABEL	DESCRIPTION
64	This field shows the number of packets (including bad packets) received that were 64 octets in length.
65-127	This field shows the number of packets (including bad packets) received that were between 65 and 127 octets in length.
128-255	This field shows the number of packets (including bad packets) received that were between 128 and 255 octets in length.
256-511	This field shows the number of packets (including bad packets) received that were between 256 and 511 octets in length.
512-1023	This field shows the number of packets (including bad packets) received that were between 512 and 1023 octets in length.
1024-1518	This field shows the number of packets (including bad packets) received that were between 1024 and 1518 octets in length.
Giant	This field shows the number of packets dropped because they were bigger than the maximum frame size.





# CHAPTER 7

## Basic Setting

This chapter describes how to configure the **System Info**, **General Setup**, **Switch Setup**, **IP Setup** and **Port Setup** screens.

### 7.1 Overview

The **System Info** screen displays general switch information (such as firmware version number) and hardware polling information (such as fan speeds). The **General Setup** screen allows you to configure general switch identification information. The **General Setup** screen also allows you to set the system time manually or get the current time and date from an external server when you turn on your switch. The real time is then displayed in the switch logs. The **Switch Setup** screen allows you to set up and configure global switch features. The **IP Setup** screen allows you to configure a switch IP address, subnet mask(s) and DNS (domain name server) for management purposes.

### 7.2 System Information

In the navigation panel, click **Basic Setting** and **System Info** to display the screen as shown. You can check the firmware version number and monitor the switch temperature, fan speeds and voltage in this screen.

**Figure 27** System Info

System Info						
System Name			ES-3148			
ZyNOS FW Version			V3.70(TZ.0)b0   7/10/2006			
Ethernet Address			00:13:49:00:00:02			
Hardware Monitor						
Temperature Unit <input type="button" value="C"/>						
Temperature (C)	Current	MAX	MIN	Threshold	Status	
MAC	35.5	36.0	27.5	85.0	Normal	
CPU	32.0	32.0	25.0	85.0	Normal	
PHY	31.5	32.0	25.5	85.0	Normal	
FAN Speed (RPM)	Current	MAX	MIN	Threshold	Status	
FAN1	6222	6334	6114	2750	Normal	
FAN2	6140	6250	6009	2750	Normal	
FAN3	6114	6222	5958	2750	Normal	
Voltage (V)	Current	MAX	MIN	Threshold	Status	
2.5	2.624	2.624	2.624	+/-8%	Normal	
1.215_GPHY	1.248	1.248	1.248	+/-11%	Normal	
3.3	3.360	3.360	3.360	+/-8%	Normal	
5	5.053	5.053	5.053	+/-7%	Normal	
12	12.099	12.160	12.099	+/-10%	Normal	
1.25_SWCoreA	1.280	1.280	1.280	+/-8%	Normal	
1.8	1.824	1.824	1.824	+/-9%	Normal	
1.3	1.312	1.312	1.312	+/-10%	Normal	
BPS_12VIN	--	--	--	--	Absent	

The following table describes the labels in this screen.

**Table 9** System Info

LABEL	DESCRIPTION
System Name	This field displays the descriptive name of the switch for identification purposes.
ZyNOS FW Version	This field displays the version number of the switch 's current firmware including the date created.
Ethernet Address	This field refers to the Ethernet MAC (Media Access Control) address of the switch.
Hardware Monitor	
Temperature Unit	The switch has temperature sensors that are capable of detecting and reporting if the temperature rises above the threshold. You may choose the temperature unit (Centigrade or Fahrenheit) in this field.
Temperature	<b>MAC</b> , <b>CPU</b> and <b>PHY</b> refer to the location of the temperature sensors on the switch printed circuit board.
Current	This field displays the current temperature measured at this sensor.
MAX	This field displays the maximum temperature measured at this sensor.
MIN	This field displays the minimum temperature measured at this sensor.
Threshold	This field displays the upper temperature limit at this sensor.
Status	This field displays <b>Normal</b> for temperatures below the threshold and <b>Error</b> for those above.

**Table 9** System Info (continued)

LABEL	DESCRIPTION
FAN speed (RPM)	A properly functioning fan is an essential component (along with a sufficiently ventilated, cool operating environment) in order for the device to stay within the temperature threshold. Each fan has a sensor that is capable of detecting and reporting if the fan speed falls below the threshold shown.
Current	This field displays this fan's current speed in Revolutions Per Minute (RPM).
MAX	This field displays this fan's maximum speed measured in Revolutions Per Minute (RPM).
MIN	This field displays this fan's minimum speed measured in Revolutions Per Minute (RPM). "<41" is displayed for speeds too small to measure (under 2000 RPM).
Threshold	This field displays the minimum speed at which a normal fan should work.
Status	<b>Normal</b> indicates that this fan is functioning above the minimum speed. <b>Error</b> indicates that this fan is functioning below the minimum speed.
Voltage (V)	The power supply for each voltage has a sensor that is capable of detecting and reporting if the voltage falls out of the tolerance range.
Current	This is the current voltage reading.
MAX	This field displays the maximum voltage measured at this point.
MIN	This field displays the minimum voltage measured at this point.
Threshold	This field displays the minimum voltage at which the switch should work.
Status	<b>Normal</b> indicates that the voltage is within an acceptable operating range at this point; otherwise <b>Error</b> is displayed.

## 7.3 General Setup

Use this screen to configure general settings such as the system name and time. Click **Basic Setting** and **General Setup** in the navigation panel to display the screen as shown.

**Figure 28** General Setup

The following table describes the labels in this screen.

**Table 10** General Setup

LABEL	DESCRIPTION
System Name	Choose a descriptive name for identification purposes. This name consists of up to 64 printable characters; spaces are allowed.
Location	Enter the geographic location of your switch. You can use up to 32 printable ASCII characters; spaces are not allowed.
Contact Person's Name	Enter the name of the person in charge of this switch. You can use up to 32 printable ASCII characters; spaces are not allowed.
Login Precedence	<p>Use this drop-down list box to select which database the switch should use (first) to authenticate an administrator (user for switch management).</p> <p>Configure the local user accounts in the <b>Access Control Logins</b> screen. The RADIUS is an external server. Before you specify the priority, make sure you have set up the corresponding database correctly first.</p> <p>Select <b>Local Only</b> to have the switch just check the administrator accounts configured in the <b>Access Control Logins</b> screen.</p> <p>Select <b>Local then RADIUS</b> to have the switch check the administrator accounts configured in the <b>Access Control Logins</b> screen. If the user name is not found, the switch then checks the user database on the specified RADIUS server. You need to configure <b>Port Authentication Radius</b> first.</p> <p>Select <b>RADIUS Only</b> to have the switch just check the user database on the specified RADIUS server for a login username, password and the access privilege.</p>

**Table 10** General Setup (continued)

LABEL	DESCRIPTION
Use Time Server when Bootup	<p>Enter the time service protocol that your timeserver uses. Not all time servers support all protocols, so you may have to use trial and error to find a protocol that works. The main differences between them are the time format.</p> <p>When you select the <b>Daytime (RFC 867)</b> format, the switch displays the day, month, year and time with no time zone adjustment. When you use this format it is recommended that you use a Daytime timeserver within your geographical time zone.</p> <p><b>Time (RFC-868)</b> format displays a 4-byte integer giving the total number of seconds since 1970/1/1 at 0:0:0.</p> <p><b>NTP (RFC-1305)</b> is similar to Time (RFC-868).</p> <p><b>None</b> is the default value. Enter the time manually. Each time you turn on the switch, the time and date will be reset to 1970-1-1 0:0.</p>
Time Server IP Address	Enter the IP address of your timeserver. The switch searches for the timeserver for up to 60 seconds. If you select a timeserver that is unreachable, then this screen will appear locked for 60 seconds. Please wait.
Current Time	This field displays the time you open this menu (or refresh the menu).
New Time (hh:min:ss)	Enter the new time in hour, minute and second format. The new time then appears in the <b>Current Time</b> field after you click <b>Apply</b> .
Current Date	This field displays the date you open this menu.
New Date (yyyy-mm-dd)	Enter the new date in year, month and day format. The new date then appears in the <b>Current Date</b> field after you click <b>Apply</b> .
Time Zone	Select the time difference between UTC (Universal Time Coordinated, formerly known as GMT, Greenwich Mean Time) and your time zone from the drop-down list box.
Apply	Click <b>Apply</b> to save your changes to the switch's run-time memory. The switch loses these changes if it is turned off or loses power, so use the <b>Save</b> link on the top navigation panel to save your changes to the non-volatile memory when you are done configuring.
Cancel	Click <b>Cancel</b> to reset the fields.

## 7.4 Introduction to VLANs

A VLAN (Virtual Local Area Network) allows a physical network to be partitioned into multiple logical networks. Devices on a logical network belong to one group. A device can belong to more than one group. With VLAN, a device cannot directly talk to or hear from devices that are not in the same group(s); the traffic must first go through a router.

In MTU (Multi-Tenant Unit) applications, VLAN is vital in providing isolation and security among the subscribers. When properly configured, VLAN prevents one subscriber from accessing the network resources of another on the same LAN, thus a user will not see the printers and hard disks of another user in the same building.

VLAN also increases network performance by limiting broadcasts to a smaller and more manageable logical broadcast domain. In traditional switched environments, all broadcast packets go to each and every individual port. With VLAN, all broadcasts are confined to a specific broadcast domain.

**Note:** VLAN is unidirectional; it only governs outgoing traffic.

See [Chapter 8 on page 87](#) for information on port-based and 802.1Q tagged VLANs.

## 7.5 Switch Setup Screen

Click **Basic Setting** and then **Switch Setup** in the navigation panel to display the screen as shown. The VLAN setup screens change depending on whether you choose **802.1Q** or **Port Based** in the **VLAN Type** field in this screen. Refer to the chapter on VLAN.

**Figure 29** Switch Setup

The following table describes the labels in this screen.

**Table 11** Switch Setup

LABEL	DESCRIPTION
VLAN Type	Choose <b>802.1Q</b> or <b>Port Based</b> . The <b>VLAN Setup</b> screen changes depending on whether you choose <b>802.1Q</b> VLAN type or <b>Port Based</b> VLAN type in this screen. See <a href="#">Chapter 8 on page 87</a> for more information.
Bridge Control Protocol Transparency	Select <b>Active</b> to allow the switch to handle bridging control protocols (STP for example). You also need to define how to treat a BPDU in the <b>Port Setup</b> screen.
MAC Address Learning	MAC address learning reduces outgoing traffic broadcasts. For MAC address learning to occur on a port, the port must be active.

**Table 11** Switch Setup (continued)

LABEL	DESCRIPTION
Aging Time	Enter a time from 10 to 3000 seconds. This is how long all dynamically learned MAC addresses remain in the MAC address table before they age out (and must be relearned).
GARP Timer: Switches join VLANs by making a declaration. A declaration is made by issuing a <b>Join</b> message using GARP. Declarations are withdrawn by issuing a <b>Leave</b> message. A <b>Leave All</b> message terminates all registrations. GARP timers set declaration timeout values. See the chapter on VLAN setup for more background information.	
Join Timer	Join Timer sets the duration of the Join Period timer for GVRP in milliseconds. Each port has a <b>Join Period</b> timer. The allowed <b>Join Time</b> range is between 100 and 65535 milliseconds; the default is 200 milliseconds. See the chapter on VLAN setup for more background information.
Leave Timer	Leave Time sets the duration of the <b>Leave Period</b> timer for GVRP in milliseconds. Each port has a single <b>Leave Period</b> timer. Leave Time must be two times larger than <b>Join Timer</b> ; the default is 600 milliseconds.
Leave All Timer	Leave All Timer sets the duration of the Leave All Period timer for GVRP in milliseconds. Each port has a single Leave All Period timer. Leave All Timer must be larger than Leave Timer.
<p>Priority Queue Assignment</p> <p>IEEE 802.1p defines up to eight separate traffic types by inserting a tag into a MAC-layer frame that contains bits to define class of service. Frames without an explicit priority tag are given the default priority of the ingress port. Use the next two fields to configure the priority level-to-physical queue mapping.</p> <p>The switch has eight physical queues that you can map to the 8 priority levels. On the switch, traffic assigned to higher index queues gets through faster while traffic in lower index queues is dropped if the network is congested.</p>	
Priority Level (The following descriptions are based on the traffic types defined in the IEEE 802.1d standard (which incorporates the 802.1p)).	
Level 7	Typically used for network control traffic such as router configuration messages.
Level 6	Typically used for voice traffic that is especially sensitive to jitter (jitter is the variations in delay).
Level 5	Typically used for video that consumes high bandwidth and is sensitive to jitter.
Level 4	Typically used for controlled load, latency-sensitive traffic such as SNA (Systems Network Architecture) transactions.
Level 3	Typically used for "excellent effort" or better than best effort and would include important business traffic that can tolerate some delay.
Level 2	This is for "spare bandwidth".
Level 1	This is typically used for non-critical "background" traffic such as bulk transfers that are allowed but that should not affect other applications and users.
Level 0	Typically used for best-effort traffic.
Apply	Click <b>Apply</b> to save your changes to the switch's run-time memory. The switch loses these changes if it is turned off or loses power, so use the <b>Save</b> link on the top navigation panel to save your changes to the non-volatile memory when you are done configuring.
Cancel	Click <b>Cancel</b> to reset the fields.

## 7.6 IP Setup

Use the **IP Setup** screen to configure the default gateway device, the default domain name server and add switch IP address.

### 7.6.1 Management IP Addresses

The switch needs an IP address for it to be managed over the network. The factory default IP address is 192.168.1.1. The subnet mask specifies the network number portion of an IP address. The factory default subnet mask is 255.255.255.0.

You can configure up to 64 IP addresses which are used to access and manage the switch from the ports belonging to the pre-defined VLAN(s).

**Note:** You must configure a VLAN first.



**Figure 30** IP Setup

IP Setup

Domain Name Server

Default Management  In-band  Out-of-band

---

**In-band Management IP Address**

DHCP Client  
 Static IP Address

IP Address

IP Subnet Mask

Default Gateway

VID

**Out-of-band Management IP Address**

IP Address

IP Subnet Mask

Default Gateway

---

**In-band IP Addresses**

IP Address	<input style="width: 100%;" type="text" value="0.0.0.0"/>
IP Subnet Mask	<input style="width: 100%;" type="text" value="0.0.0.0"/>
VID	<input style="width: 100%;" type="text"/>
Default Gateway	<input style="width: 100%;" type="text" value="0.0.0.0"/>
Manageable	<input type="checkbox"/>

---

Index	IP Address	IP Subnet Mask	VID	Default Gateway	Manageable	Delete
<input type="button" value="Delete"/> <input type="button" value="Cancel"/>						

The following table describes the labels in this screen.

**Table 12** IP Setup

LABEL	DESCRIPTION
Domain Name Server	DNS (Domain Name System) is for mapping a domain name to its corresponding IP address and vice versa. Enter a domain name server IP address in order to be able to use a domain name instead of an IP address.
Default Management	Specify which traffic flow (In-Band or Out-of-band) the switch is to send packets originating from itself (such as SNMP traps) or packets with unknown source. Select <b>Out-of-band</b> to have the switch send the packets to the out-of-band management port. This means that device(s) connected to the other port(s) do not receive these packets. Select <b>In-Band</b> to have the switch send the packets to all ports except the out-of-band management port to which connected device(s) do not receive these packets.
In-band Management IP Address	
DHCP Client	Select this option if you have a DHCP server that can assign the switch an IP address, subnet mask, a default gateway IP address and a domain name server IP address automatically.
Static IP Address	Select this option if you don't have a DHCP server or if you wish to assign static IP address information to the switch. You need to fill in the following fields when you select this option.
IP Address	Enter the IP address of your switch in dotted decimal notation for example 192.168.1.1.
IP Subnet Mask	Enter the IP subnet mask of your switch in dotted decimal notation for example 255.255.255.0.
Default Gateway	Enter the IP address of the default outgoing gateway in dotted decimal notation, for example 192.168.1.254.
VID	Enter the VLAN identification number associated with the switch IP address. VID is the VLAN ID of the CPU and is used for management only. The default is "1". All ports, by default, are fixed members of this "management VLAN" in order to manage the device from any port. If a port is not a member of this VLAN, then users on that port cannot access the device. To access the switch make sure the port that you are connected to is a member of Management VLAN.
Out-of-band Management IP Address	
IP Address	Enter the IP address of your switch in dotted decimal notation for example 192.168.0.1. If you change this IP address, make sure the computer connected to this management port is in the same subnet before accessing the switch.
IP Subnet Mask	Enter the IP subnet mask of your switch in dotted decimal notation for example 255.255.255.0.
Default Gateway	Enter the IP address of the default outgoing gateway in dotted decimal notation, for example 192.168.0.254.
Apply	Click <b>Apply</b> to save your changes to the switch's run-time memory. The switch loses these changes if it is turned off or loses power, so use the <b>Save</b> link on the top navigation panel to save your changes to the non-volatile memory when you are done configuring.
Cancel	Click <b>Cancel</b> to reset the fields.
In-band IP Addresses	You can create up to 64 IP addresses which are used to access and manage the switch from the ports belonging to the pre-defined VLAN(s). You must configure a VLAN first.
IP Address	Enter the IP address for managing the switch by the members of the VLAN specified in the <b>VID</b> field below.

**Table 12** IP Setup (continued)

LABEL	DESCRIPTION
IP Subnet Mask	Enter the IP subnet mask in dotted decimal notation.
VID	Type the VLAN group identification number.
Default Gateway	Enter the IP address of the default outgoing gateway in dotted decimal notation.
Manageable	Select this option to allow the switch to be managed using this specified IP address.
Add	Click <b>Add</b> to save the new rule to the switch's run-time memory. It then displays in the summary table at the bottom of the screen.
Cancel	Click <b>Cancel</b> to reset the fields.
Index	This field displays the index number of an entry. Click an index number to edit the rule.
IP Address	This field displays the IP address.
Subnet Mask	This field displays the subnet mask.
VID	This field displays the VLAN identification number of the network.
Default Gateway	This field displays the IP address of the default outgoing gateway.
Manageable	This field displays whether the switch can be managed using the specified IP address.
Delete	Click <b>Delete</b> to remove the selected entry from the summary table.
Cancel	Click <b>Cancel</b> to clear the <b>Delete</b> check boxes.

## 7.7 Port Setup

Use this screen to configure switch port settings. Click **Basic Setting** and then **Port Setup** in the navigation panel to enter the port configuration screen.

Full-duplex mode operation only applies to point-to-point access (for example, when attaching the switch to a workstation, server, or another switch). When connecting to hubs, use a standard cascaded connection set at half-duplex operation.

Auto-negotiation regulates the speed and duplex of each port, based on the capability of both devices. When auto-negotiation is turned on, an Ethernet port on the ZyXEL switch negotiates with the peer automatically to determine the connection speed and duplex mode. If the peer Ethernet port does not support auto-negotiation or turns off this feature, the ZyXEL switch determines the connection speed by detecting the signal on the cable and using half duplex mode. When the ZyXEL switch's auto-negotiation is turned off, an Ethernet port uses the preconfigured speed and duplex mode when making a connection, thus requiring you to make sure that the settings of the peer Ethernet port are the same in order to connect.

**Figure 31** Port Setup

Port	Active	Name	Type	Speed / Duplex	Flow Control	802.1p Priority	BPDU Control
*	<input type="checkbox"/>		-	Auto	<input type="checkbox"/>	0	Peer
1	<input checked="" type="checkbox"/>		10/100M	Auto	<input type="checkbox"/>	0	Peer
2	<input checked="" type="checkbox"/>		10/100M	Auto	<input type="checkbox"/>	0	Peer
3	<input checked="" type="checkbox"/>		10/100M	Auto	<input type="checkbox"/>	0	Peer
45	<input checked="" type="checkbox"/>		10/100M	Auto	<input type="checkbox"/>	0	Peer
46	<input checked="" type="checkbox"/>		10/100M	Auto	<input type="checkbox"/>	0	Peer
47	<input checked="" type="checkbox"/>		10/100M	Auto	<input type="checkbox"/>	0	Peer
48	<input checked="" type="checkbox"/>		10/100M	Auto	<input type="checkbox"/>	0	Peer
49	<input checked="" type="checkbox"/>		10/100/1000M	Auto	<input type="checkbox"/>	0	Peer
50	<input checked="" type="checkbox"/>		10/100/1000M	Auto	<input type="checkbox"/>	0	Peer
51	<input checked="" type="checkbox"/>		10/100/1000M	Auto	<input type="checkbox"/>	0	Peer
52	<input checked="" type="checkbox"/>		10/100/1000M	Auto	<input type="checkbox"/>	0	Peer

Apply Cancel

The following table describes the labels in this screen.

**Table 13** Port Setup

LABEL	DESCRIPTION
*	<p>Settings in this row apply to all ports.</p> <p>Use this row only if you want to make some settings the same for all ports. Use this row first to set the common settings and then make adjustments on a port-by-port basis.</p> <p><b>Note:</b> Changes in this row are copied to all the ports as soon as you make them.</p>
Port	This is the port index number.
Active	Select this check box to enable a port. The factory default for all ports is enabled. A port must be enabled for data transmission to occur.
Name	Enter a descriptive name that identifies this port.
Type	This field displays <b>10/100M</b> for an Ethernet/Fast Ethernet connection and <b>10/100/1000M</b> for Gigabit connections.
Speed/Duplex	<p>Select the speed and the duplex mode of the Ethernet connection on this port. Choices are <b>Auto</b>, <b>10M/Half Duplex</b>, <b>10M/Full Duplex</b>, <b>100M/Half Duplex</b>, <b>100M/Full Duplex</b> and <b>1000M/Full Duplex</b> (for Gigabit ports only).</p> <p>Selecting <b>Auto</b> (auto-negotiation) allows one port to negotiate with a peer port automatically to obtain the connection speed and duplex mode that both ends support. When auto-negotiation is turned on, a port on the switch negotiates with the peer automatically to determine the connection speed and duplex mode. If the peer port does not support auto-negotiation or turns off this feature, the switch determines the connection speed by detecting the signal on the cable and using half duplex mode. When the switch's auto-negotiation is turned off, a port uses the pre-configured speed and duplex mode when making a connection, thus requiring you to make sure that the settings of the peer port are the same in order to connect.</p>

**Table 13** Port Setup (continued)

LABEL	DESCRIPTION
Flow Control	<p>A concentration of traffic on a port decreases port bandwidth and overflows buffer memory causing packet discards and frame losses. <b>Flow Control</b> is used to regulate transmission of signals to match the bandwidth of the receiving port.</p> <p>The switch uses IEEE802.3x flow control in full duplex mode and backpressure flow control in half duplex mode.</p> <p>IEEE802.3x flow control is used in full duplex mode to send a pause signal to the sending port, causing it to temporarily stop sending signals when the receiving port memory buffers fill.</p> <p>Back Pressure flow control is typically used in half duplex mode to send a "collision" signal to the sending port (mimicking a state of packet collision) causing the sending port to temporarily stop sending signals and resend later. Select <b>Flow Control</b> to enable it.</p>
802.1p Priority	<p>This priority value is added to incoming frames without a (802.1p) priority queue tag. See <b>Priority Queue Assignment</b> in <a href="#">Table 11 on page 78</a> for more information.</p>
BPDU Control	<p>Configure the way to treat BPDUs received on this port. You must activate bridging control protocol transparency in the <b>Switch Setup</b> screen first.</p> <p>Select <b>Peer</b> to process any BPDU (Bridge Protocol Data Units) received on this port.</p> <p>Select <b>Tunnel</b> to forward BPDUs received on this port.</p> <p>Select <b>Discard</b> to drop any BPDU received on this port.</p> <p>Select <b>Network</b> to process a BPDU with no VLAN tag and forward a tagged BPDU.</p>
Apply	<p>Click <b>Apply</b> to save your changes to the switch's run-time memory. The switch loses these changes if it is turned off or loses power, so use the <b>Save</b> link on the top navigation panel to save your changes to the non-volatile memory when you are done configuring.</p>
Cancel	<p>Click <b>Cancel</b> to reset the fields.</p>



# CHAPTER 8

## VLAN

The type of screen you see here depends on the **VLAN Type** you selected in the **Switch Setup** screen. This chapter shows you how to configure 802.1Q tagged and port-based VLANs.

### 8.1 Introduction to IEEE 802.1Q Tagged VLAN

A tagged VLAN uses an explicit tag (VLAN ID) in the MAC header to identify the VLAN membership of a frame across bridges - they are not confined to the switch on which they were created. The VLANs can be created statically by hand or dynamically through GVRP. The VLAN ID associates a frame with a specific VLAN and provides the information that switches need to process the frame across the network. A tagged frame is four bytes longer than an untagged frame and contains two bytes of TPID (Tag Protocol Identifier, residing within the type/length field of the Ethernet frame) and two bytes of TCI (Tag Control Information, starts after the source address field of the Ethernet frame).

The CFI (Canonical Format Indicator) is a single-bit flag, always set to zero for Ethernet switches. If a frame received at an Ethernet port has a CFI set to 1, then that frame should not be forwarded as it is to an untagged port. The remaining twelve bits define the VLAN ID, giving a possible maximum number of 4,096 (2<sup>12</sup>) VLANs. Note that user priority and VLAN ID are independent of each other. A frame with VID (VLAN Identifier) of null (0) is called a priority frame, meaning that only the priority level is significant and the default VID of the ingress port is given as the VID of the frame. Of the 4096 possible VIDs, a VID of 0 is used to identify priority frames and value 4095 (FFF) is reserved, so the maximum possible VLAN configurations are 4,094.

TPID	User Priority	CFI	VLAN ID
2 Bytes	3 Bits	1 Bit	12 bits

#### 8.1.1 Forwarding Tagged and Untagged Frames

Each port on the switch is capable of passing tagged or untagged frames. To forward a frame from an 802.1Q VLAN-aware switch to an 802.1Q VLAN-unaware switch, the switch first decides where to forward the frame and then strips off the VLAN tag. To forward a frame from an 802.1Q VLAN-unaware switch to an 802.1Q VLAN-aware switch, the switch first decides where to forward the frame, and then inserts a VLAN tag reflecting the ingress port's default VID. The default PVID is VLAN 1 for all ports, but this can be changed.

A broadcast frame (or a multicast frame for a multicast group that is known by the system) is duplicated only on ports that are members of the VID (except the ingress port itself), thus confining the broadcast to a specific domain.

## 8.2 Automatic VLAN Registration

GARP and GVRP are the protocols used to automatically register VLAN membership across switches.

### 8.2.1 GARP

GARP (Generic Attribute Registration Protocol) allows network switches to register and de-register attribute values with other GARP participants within a bridged LAN. GARP is a protocol that provides a generic mechanism for protocols that serve a more specific application, for example, GVRP.

#### 8.2.1.1 GARP Timers

Switches join VLANs by making a declaration. A declaration is made by issuing a Join message using GARP. Declarations are withdrawn by issuing a Leave message. A Leave All message terminates all registrations. GARP timers set declaration timeout values.

### 8.2.2 GVRP

GVRP (GARP VLAN Registration Protocol) is a registration protocol that defines a way for switches to register necessary VLAN members on ports across the network. Enable this function to permit VLANs groups beyond the local switch.

Please refer to the following table for common IEEE 802.1Q VLAN terminology.

**Table 14** IEEE 802.1Q VLAN Terminology

VLAN PARAMETER	TERM	DESCRIPTION
VLAN Type	Permanent VLAN	This is a static VLAN created manually.
	Dynamic VLAN	This is a VLAN configured by a GVRP registration/deregistration process.
VLAN Administrative Control	Registration Fixed	Fixed registration ports are permanent VLAN members.
	Registration Forbidden	Ports with registration forbidden are forbidden to join the specified VLAN.
	Normal Registration	Ports dynamically join a VLAN using GVRP.
VLAN Tag Control	Tagged	Ports belonging to the specified VLAN tag all outgoing frames transmitted.
	Untagged	Ports belonging to the specified VLAN don't tag all outgoing frames transmitted.



**Table 14** IEEE 802.1Q VLAN Terminology (continued)

VLAN PARAMETER	TERM	DESCRIPTION
VLAN Port	Port VID	This is the VLAN ID assigned to untagged frames that this port received.
	Acceptable Frame Type	You may choose to accept both tagged and untagged incoming frames, just tagged incoming frames or just untagged incoming frames on a port.
	Ingress filtering	If set, the switch discards incoming frames for VLANs that do not have this port as a member

## 8.3 Port VLAN Trunking

Enable **VLAN Trunking** on a port to allow frames belonging to unknown VLAN groups to pass through that port. This is useful if you want to set up VLAN groups on end devices without having to configure the same VLAN groups on intermediary devices.

Refer to the following figure. Suppose you want to create VLAN groups 1 and 2 (V1 and V2) on devices A and B. Without **VLAN Trunking**, you must configure VLAN groups 1 and 2 on all intermediary switches C, D and E; otherwise they will drop frames with unknown VLAN group tags. However, with **VLAN Trunking** enabled on a port(s) in each intermediary switch you only need to create VLAN groups in the end devices (A and B). C, D and E automatically allow frames with VLAN group tags 1 and 2 (VLAN groups that are unknown to those switches) to pass through their VLAN trunking port(s).

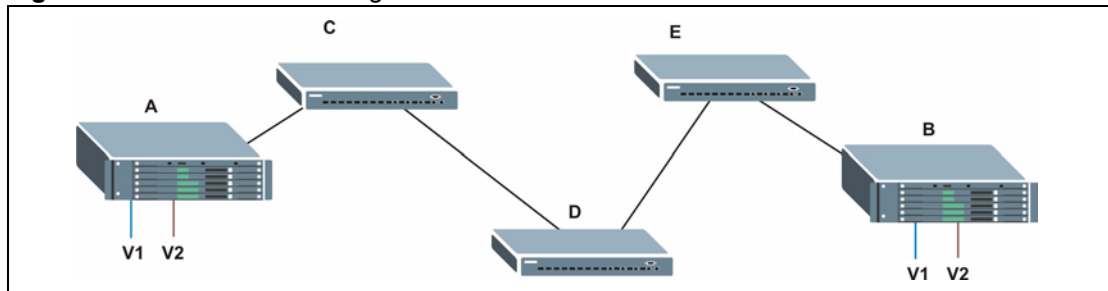
**Figure 32** Port VLAN Trunking

## 8.4 Select the VLAN Type

- 1 Select a VLAN type in the **Switch Setup** screen.

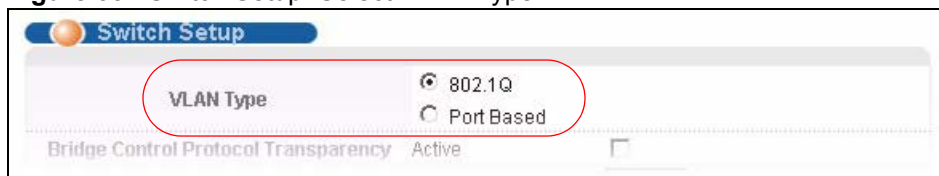
**Figure 33** Switch Setup: Select VLAN Type

## 8.5 Static VLAN

Use a static VLAN to decide whether an incoming frame on a port should be

- sent to a VLAN group as normal depends on its VLAN tag.
- sent to a group whether it has a VLAN tag or not.
- blocked from a VLAN group regardless of its VLAN tag.

You can also tag all outgoing frames (that were previously untagged) from a port with the specified VID.

### 8.5.1 Static VLAN Status

See [Section 8.1 on page 87](#) for more information on Static VLAN. Click **Advanced Application, VLAN** from the navigation panel to display the **VLAN Status** screen as shown next.

**Figure 34** VLAN: VLAN Status

Index	VID	Elapsed Time	Status
1	1	0:00:12	Static
2	111	0:00:12	Static

The following table describes the labels in this screen.

**Table 15** VLAN: VLAN Status

LABEL	DESCRIPTION
The Number of VLAN	This is the number of VLANs configured on the switch.
Index	This is the VLAN index number. Click on this to view port settings for the specified VLAN.
VID	This is the VLAN identification number that was configured in the <b>Static VLAN</b> screen.
Elapsed Time	This field shows how long it has been since a normal VLAN was registered or a static VLAN was set up.
Status	This field shows how this VLAN was added to the switch; <b>dynamic</b> - using GVRP, <b>static</b> - added as a permanent entry or <b>other</b> - added using Multicast VLAN Registration (MVR).
Change Pages	Click <b>Previous</b> or <b>Next</b> to show the previous/next screen if all status information cannot be seen in one screen.

## 8.5.2 Static VLAN Details

Use this screen to view detailed port settings and status of the VLAN group. See [Section 8.5 on page 90](#) for more information on static VLAN. Click on an index number in the **VLAN Status** screen to display VLAN details.

**Figure 35** Static VLAN Details

VID	Port Number																								Elapsed Time	Status			
	2	4	6	8	10	12	14	16	18	20	22	24	26	28	30	32	34	36	38	40	42	44	46	48			50	52	
1	U	U	U	U	U	U	U	U	U	U	U	U	U	U	U	U	U	U	U	U	U	U	U	U	U	U	U	4:07:14	Static

The following table describes the labels in this screen.

**Table 16** Static VLAN Details

LABEL	DESCRIPTION
VLAN Status	Click this to go to the <b>VLAN Status</b> screen.
VID	This is the VLAN identification number that was configured in the <b>Static VLAN</b> screen.
Port Number	This column displays the ports that are participating in a VLAN. A tagged port is marked as <b>T</b> , an untagged port is marked as <b>U</b> and ports not participating in a VLAN are marked as “-”.
Elapsed Time	This field shows how long it has been since a normal VLAN was registered or a static VLAN was set up.
Status	This field shows how this VLAN was added to the switch; <b>dynamic</b> - using GVRP, <b>static</b> - added as a permanent entry or <b>other</b> - added using Multicast VLAN Registration (MVR).

## 8.5.3 Configure a Static VLAN

Use this screen to configure and view 802.1Q VLAN parameters for the switch. See [Section 8.5 on page 90](#) for more information on static VLAN. To configure a static VLAN, click **Static VLAN** in the **VLAN Status** screen to display the screen as shown next.

**Figure 36** VLAN: Static VLAN

The screenshot shows the 'Static VLAN' configuration page. At the top, there is a title bar with 'Static VLAN' and a 'VLAN Status' link. Below the title bar, there is an 'ACTIVE' checkbox. Underneath are two input fields: 'Name' and 'VLAN Group ID'. The main part of the page is a table with columns for 'Port', 'Control', and 'Tagging'. The 'Control' column has radio buttons for 'Normal', 'Fixed', and 'Forbidden'. The 'Tagging' column has a checkbox for 'Tx Tagging'. The first row is a summary row marked with an asterisk (\*). Below it are rows for ports 1 through 52. At the bottom of the table are three buttons: 'Add', 'Cancel', and 'Clear'.

The following table describes the related labels in this screen.

**Table 17** VLAN: Static VLAN

LABEL	DESCRIPTION
ACTIVE	Select this check box to activate the VLAN settings.
Name	Enter a descriptive name for the VLAN group for identification purposes.
VLAN Group ID	Enter the VLAN ID for this static entry; the valid range is between 1 and 4094.
Port	The port number identifies the port you are configuring.
*	Settings in this row apply to all ports. Use this row only if you want to make some settings the same for all ports. Use this row first to set the common settings and then make adjustments on a port-by-port basis.  <b>Note:</b> Changes in this row are copied to all the ports as soon as you make them.
Control	Select <b>Normal</b> for the port to dynamically join this VLAN group using GVRP. This is the default selection. Select <b>Fixed</b> for the port to be a permanent member of this VLAN group. Select <b>Forbidden</b> if you want to prohibit the port from joining this VLAN group.
Tagging	Select <b>TX Tagging</b> if you want the port to tag all outgoing frames transmitted with this VLAN Group ID.

**Table 17** VLAN: Static VLAN (continued)

LABEL	DESCRIPTION
Add	Click <b>Add</b> to save your changes to the switch's run-time memory. The switch loses these changes if it is turned off or loses power, so use the <b>Save</b> link on the top navigation panel to save your changes to the non-volatile memory when you are done configuring.
Cancel	Click <b>Cancel</b> to reset the fields.
Clear	Click <b>Clear</b> to start configuring the screen again.
VID	This field displays the ID number of the VLAN group. Click the number to edit the VLAN settings.
Active	This field indicates whether the VLAN settings are enabled ( <b>Yes</b> ) or disabled ( <b>No</b> ).
Name	This field displays the descriptive name for this VLAN group.
Delete	Click <b>Delete</b> to remove the selected entry from the summary table.
Cancel	Click <b>Cancel</b> to clear the <b>Delete</b> check boxes.

## 8.5.4 Configure VLAN Port Settings

Use the VLAN Port Setting screen to configure the static VLAN (IEEE 802.1Q) settings on a port. See [Section 8.5 on page 90](#) for more information on static VLAN. Click the **VLAN Port Setting** link in the **VLAN Status** screen.

**Figure 37** VLAN: VLAN Port Setting

Port	Ingress Check	PVID	GVRP	Acceptable Frame Type	VLAN Trunking
*	<input type="checkbox"/>		<input type="checkbox"/>	All	<input type="checkbox"/>
1	<input type="checkbox"/>	1	<input type="checkbox"/>	All	<input type="checkbox"/>
2	<input type="checkbox"/>	1	<input type="checkbox"/>	All	<input type="checkbox"/>
3	<input type="checkbox"/>	1	<input type="checkbox"/>	All	<input type="checkbox"/>
45	<input type="checkbox"/>	1	<input type="checkbox"/>	All	<input type="checkbox"/>
46	<input type="checkbox"/>	1	<input type="checkbox"/>	All	<input type="checkbox"/>
47	<input type="checkbox"/>	1	<input type="checkbox"/>	All	<input type="checkbox"/>
48	<input type="checkbox"/>	1	<input type="checkbox"/>	All	<input type="checkbox"/>
49	<input type="checkbox"/>	1	<input type="checkbox"/>	All	<input type="checkbox"/>
50	<input type="checkbox"/>	1	<input type="checkbox"/>	All	<input type="checkbox"/>
51	<input type="checkbox"/>	1	<input type="checkbox"/>	All	<input type="checkbox"/>
52	<input type="checkbox"/>	1	<input type="checkbox"/>	All	<input type="checkbox"/>

The following table describes the labels in this screen.

**Table 18** VLAN: VLAN Port Setting

LABEL	DESCRIPTION
GVRP	GVRP (GARP VLAN Registration Protocol) is a registration protocol that defines a way for switches to register necessary VLAN members on ports across the network. Select this check box to permit VLAN groups beyond the local switch.
Port isolation	<b>Port Isolation</b> allows each port to communicate only with the CPU management port but not communicate with each other. All incoming ports are selected while only the CPU outgoing port is selected. This option is the most limiting but also the most secure.
Port	This field displays the port number.
*	Settings in this row apply to all ports. Use this row only if you want to make some settings the same for all ports. Use this row first to set the common settings and then make adjustments on a port-by-port basis.  <b>Note:</b> Changes in this row are copied to all the ports as soon as you make them.
Ingress Check	If this check box is selected for a port, the device discards incoming frames for VLANs that do not include this port in its member set. Clear this check box to disable ingress filtering.
PVID	Enter a number between 1 and 4094 as the port VLAN ID.
GVRP	Select this check box to allow GVRP on this port.
Acceptable Frame Type	Specify the type of frames allowed on a port. Choices are <b>All</b> , <b>Tag Only</b> and <b>Untag Only</b> . Select <b>All</b> from the drop-down list box to accept all untagged or tagged frames on this port. This is the default setting. Select <b>Tag Only</b> to accept only tagged frames on this port. All untagged frames will be dropped. Select <b>Untag Only</b> to accept only untagged frames on this port. All tagged frames will be dropped.
VLAN Trunking	Enable <b>VLAN Trunking</b> on ports connected to other switches or routers (but not ports directly connected to end users) to allow frames belonging to unknown VLAN groups to pass through the switch.
Apply	Click <b>Apply</b> to save your changes to the switch's run-time memory. The switch loses these changes if it is turned off or loses power, so use the <b>Save</b> link on the top navigation panel to save your changes to the non-volatile memory when you are done configuring.
Cancel	Click <b>Cancel</b> to reset the fields.

## 8.6 Protocol Based VLANs

Protocol based VLANs allow you to group traffic into logical VLANs based on the protocol you specify. When an upstream frame is received on a port (configured for a protocol based VLAN), the switch checks if a tag is added already and its protocol. The untagged packets of the same protocol are then placed in the same protocol based VLAN. One advantage of using protocol based VLANs is that priority can be assigned to traffic of the same protocol.

**Note:** Protocol based VLAN applies to un-tagged packets and is applicable only when you use IEEE 802.1Q tagged VLAN.

For example, port 1, 2, 3 and 4 belong to static VLAN 100, and port 4, 5, 6, 7 belong to static VLAN 120. You configure a protocol based VLAN A with priority 3 for ARP traffic received on port 1, 2 and 3. You also have a protocol based VLAN B with priority 2 for Apple Talk traffic received on port 6 and 7. All upstream ARP traffic from port 1, 2 and 3 will be grouped together, and all upstream Apple Talk traffic from port 6 and 7 will be in another group and have higher priority than ARP traffic, when they go through the uplink port to a backbone switch C.

**Figure 38** Protocol Based VLAN Application Example

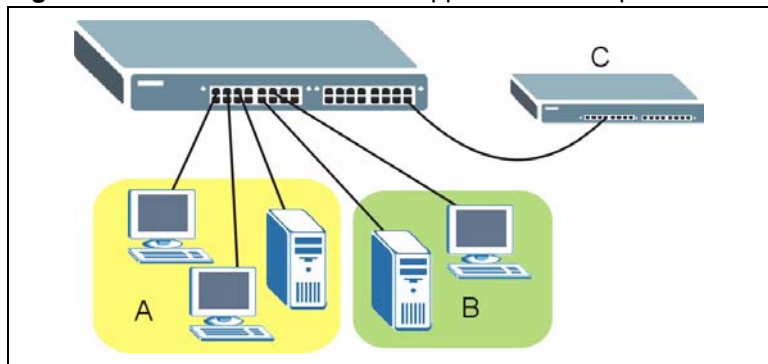

## 8.7 Configuring Protocol Based VLAN

Click **Advanced Application, VLAN Port Setting, Protocol Based VLAN** in the navigation panel to display the configuration screen as shown.

**Note:** Protocol-based VLAN applies to un-tagged packets and is applicable only when you use IEEE 802.1Q tagged VLAN.

**Figure 39** Protocol Based VLAN

The following table describes the labels in this screen.

**Table 19** Protocol Based VLAN Setup

LABEL	DESCRIPTION
Active	Check this box to activate this protocol based VLAN.
Port	Type a port to be included in this protocol based VLAN. This port must belong to a static VLAN in order to participate in a protocol based VLAN. See <a href="#">Chapter 8 on page 87</a> for more details on setting up VLANs.
Name	Enter up to 11 alphanumeric characters to identify this protocol based VLAN.
Ethernet-type	Use the drop down list box to select a predefined protocol to be included in this protocol based VLAN or select <b>Others</b> and type the protocol number in hexadecimal notation. For example the IP protocol in hexadecimal notation is 0800, and Novell IPX protocol is 8137.  <b>Note:</b> Protocols in the hexadecimal number range of 0x0000 to 0x05ff are not allowed to be used for protocol based VLANs.
VID	Enter the ID of a VLAN to which the port belongs. This must be an existing VLAN which you defined in the <b>Advanced Applications, VLAN</b> screens.
Priority	Select the priority level that the switch will assign to frames belonging to this VLAN.
Add	Click <b>Add</b> to save your changes to the switch's run-time memory. The switch loses these changes if it is turned off or loses power, so use the <b>Save</b> link on the top navigation panel to save your changes to the non-volatile memory when you are done configuring.
Cancel	Click <b>Cancel</b> to reset the fields.
Index	This is the index number identifying this protocol based VLAN. Click on any of these numbers to edit an existing protocol based VLAN.
Active	This field shows whether the protocol based VLAN is active or not.
Port	This field shows which port belongs to this protocol based VLAN.



**Table 19** Protocol Based VLAN Setup (continued)

LABEL	DESCRIPTION
Name	This field shows the name the protocol based VLAN.
Ethernet Type	This field shows which Ethernet protocol is part of this protocol based VLAN.
VID	This field shows the VLAN ID of the port.
Priority	This field shows the priority which is assigned to frames belonging to this protocol based VLAN.
Delete	Click this to delete the protocol based VLANs which you marked for deletion.
Cancel	Click <b>Cancel</b> to reset the fields.

## 8.8 Create an IP-based VLAN Example

This example shows you how to create an IP VLAN which includes ports 1, 4 and 8. Follow these steps:

- 1 Activate this protocol based VLAN.
- 2 Type the port number you want to include in this protocol based VLAN. Type **1**.
- 3 Give this protocol-based VLAN a descriptive name. Type **IP-VLAN**.
- 4 Select the protocol. Leave the default value **IP**.
- 5 Type the VLAN ID of an existing VLAN. In our example we already created a static VLAN with an ID of 5. Type **5**.
- 6 Leave the priority set to **0** and click **Add**.

**Figure 40** Protocol Based VLAN Configuration Example

The screenshot shows the 'Protocol Based VLAN' configuration window. The 'Active' checkbox is checked. The 'Port' field is set to 1, 'Name' is IP-VLAN, 'Ethernet-type' is IP, 'VID' is 5, and 'Priority' is 0. There are 'Add' and 'Cancel' buttons below the form. Below the form is a table with columns: Index, Active, Port, Name, Ethernet-type, VID, Priority, Delete. The table is currently empty. Below the table are 'Delete' and 'Cancel' buttons.

To add more ports to this protocol based VLAN.

- 1 Click the index number of the protocol based VLAN entry. Click **1**.

- 2 Change the value in the **Port** field to the next port you want to add.
- 3 Click **Add**.

## 8.9 Port-based VLAN Setup

Port-based VLANs are VLANs where the packet forwarding decision is based on the destination MAC address and its associated port.

Port-based VLANs require allowed outgoing ports to be defined for each port. Therefore, if you wish to allow two subscriber ports to talk to each other, for example, between conference rooms in a hotel, you must define the egress (an egress port is an outgoing port, that is, a port through which a data packet leaves) for both ports.

Port-based VLANs are specific only to the switch on which they were created.

**Note:** When you activate port-based VLAN, the switch uses a default VLAN ID of 1. You cannot change it.

In screens (such as **IP Setup** and **Filtering**) that require a VID, you must enter 1 as the VID.

The port-based VLAN setup screen is shown next. The **CPU** management port forms a VLAN with all Ethernet ports.

### 8.9.1 Configure a Port-based VLAN

Select **Port Based** as the **VLAN Type** in the **Switch Setup** screen (see [Figure 33 on page 89](#)) and then click **VLAN** from the navigation panel to display the next screen.





The following table describes the labels in this screen.

**Table 20** Port Based VLAN Setup

LABEL	DESCRIPTION
Setting Wizard	<p>Choose <b>All connected</b> or <b>Port isolation</b>.</p> <p><b>All connected</b> means all ports can communicate with each other, that is, there are no virtual LANs. All incoming and outgoing ports are selected. This option is the most flexible but also the least secure.</p> <p><b>Port isolation</b> means that each port can only communicate with the CPU management port and cannot communicate with each other. All incoming ports are selected while only the CPU outgoing port is selected. This option is the most limiting but also the most secure.</p> <p>After you make your selection, click <b>Apply</b> (top right of screen) to display the screens as mentioned above. You can still customize these settings by adding/deleting incoming or outgoing ports, but you must also click <b>Apply</b> at the bottom of the screen.</p>
Incoming	<p>These are the ingress ports; an ingress port is an incoming port, that is, a port through which a data packet enters. If you wish to allow two subscriber ports to talk to each other, you must define the ingress port for both ports. The numbers in the top row denote the incoming port for the corresponding port listed on the left (its outgoing port). <b>CPU</b> refers to the switch management port. By default it forms a VLAN with all Ethernet ports. If it does not form a VLAN with a particular port then the switch cannot be managed from that port.</p>
Outgoing	<p>These are the egress ports; an egress port is an outgoing port, that is, a port through which a data packet leaves. If you wish to allow two subscriber ports to talk to each other, you must define the egress port for both ports. <b>CPU</b> refers to the switch management port. By default it forms a VLAN with all Ethernet ports. If it does not form a VLAN with a particular port then the switch cannot be managed from that port.</p>
Apply	<p>Click <b>Apply</b> to save your changes to the switch's run-time memory. The switch loses these changes if it is turned off or loses power, so use the <b>Save</b> link on the top navigation panel to save your changes to the non-volatile memory when you are done configuring.</p>
Cancel	<p>Click <b>Cancel</b> to reset the fields.</p>





# CHAPTER 9

## Static MAC Forwarding

Use these screens to configure static MAC address forwarding.

### 9.1 Configuring Static MAC Forwarding

A static MAC address is an address that has been manually entered in the MAC address table. Static MAC addresses do not age out. When you set up static MAC address rules, you are setting static MAC addresses for a port. This may reduce the need for broadcasting.

Static MAC address forwarding together with port security allow only computers in the MAC address table on a port to access the switch. See [Chapter 17 on page 137](#) for more information on port security.

Click **Advanced Applications, Static MAC Forwarding** in the navigation panel to display the configuration screen as shown.

**Figure 43** Static MAC Forwarding

The screenshot shows the 'Static MAC Forwarding' configuration interface. It includes a form with the following fields:

- Active:** A checkbox that is currently unchecked.
- Name:** A text input field.
- MAC Address:** Six text input fields separated by colons, representing the MAC address.
- VID:** A text input field.
- Port:** A text input field.

Below the form are three buttons: **Add**, **Cancel**, and **Clear**. At the bottom of the screen, there is a table with the following columns: **Index**, **Active**, **Name**, **MAC Address**, **VID**, **Port**, and **Delete**. Below the table are two buttons: **Delete** and **Cancel**.

The following table describes the labels in this screen.

**Table 21** Static MAC Forwarding

LABEL	DESCRIPTION
Active	Select this check box to activate your rule. You may temporarily deactivate a rule without deleting it by clearing this check box.
Name	Enter a descriptive name for identification purposes for this static MAC address forwarding rule.
MAC Address	Enter the MAC address in valid MAC address format, that is, six hexadecimal character pairs.  <b>Note:</b> Static MAC addresses do not age out.
VID	Enter the VLAN identification number.
Port	Enter the port where the MAC address entered in the previous field will be automatically forwarded.
Add	Click <b>Apply</b> to save your rule to the switch's run-time memory. The switch loses this rule if it is turned off or loses power, so use the <b>Save</b> link on the top navigation panel to save your changes to the non-volatile memory when you are done configuring.
Cancel	Click <b>Cancel</b> to reset the fields.
Clear	Click <b>Clear</b> to begin configuring this screen afresh.
Index	Click an index number to modify a static MAC address rule for a port.
Active	This field displays whether this static MAC address forwarding rule is active ( <b>Yes</b> ) or not ( <b>No</b> ). You may temporarily deactivate a rule without deleting it.
Name	This field displays the descriptive name for identification purposes for this static MAC address-forwarding rule.
MAC Address	This field displays the MAC address that will be forwarded and the VLAN identification number to which the MAC address belongs.
VID	This field displays the ID number of the VLAN group.
Port	This field displays the port where the MAC address shown in the next field will be forwarded.
Delete	Click <b>Delete</b> to remove the selected entry from the summary table.
Cancel	Click <b>Cancel</b> to clear the <b>Delete</b> check boxes.



# CHAPTER 10

## Filtering

This chapter discusses static IP and MAC address port filtering.

### 10.1 Configure a Filtering Rule

Filtering means sifting traffic going through the switch based on the source and/or destination MAC addresses and VLAN group (ID).

Click **Advanced Application** and **Filtering** in the navigation panel to display the screen as shown next.

**Figure 44** Filtering

The following table describes the related labels in this screen.

**Table 22** Filtering

LABEL	DESCRIPTION
Active	Make sure to select this check box to activate your rule. You may temporarily deactivate a rule without deleting it by deselecting this check box.
Name	Type a descriptive name (up to 32 printable ASCII characters) for this rule. This is for identification purpose only.

**Table 22** Filtering (continued)

LABEL	DESCRIPTION
Action	<p>Select <b>Discard source</b> to drop frame from the source MAC address (specified in the <b>MAC</b> field). The switch can still send frames to the MAC address.</p> <p>Select <b>Discard destination</b> to drop frames to the destination MAC address (specified in the <b>MAC</b> address). The switch can still receive frames originating from the MAC address.</p> <p>Select <b>Discard source</b> and <b>Discard destination</b> to block traffic to/from the MAC address specified in the <b>MAC</b> field.</p>
MAC	Type a MAC address in valid MAC address format, that is, six hexadecimal character pairs.
VID	Type the VLAN group identification number.
Add	Click <b>Add</b> to save this rule to the switch's run-time memory. The switch loses this rule if it is turned off or loses power, so use the <b>Save</b> link on the top navigation panel to save your changes to the non-volatile memory when you are done configuring.
Cancel	Click <b>Cancel</b> to reset the fields.
Clear	Click <b>Clear</b> to clear the fields to the factory defaults.
Index	This field displays the index number of the rule. Click an index number to change the settings.
Active	This field displays <b>Yes</b> when the rule is activated and <b>No</b> when is it deactivated.
Name	This field displays the descriptive name for this rule. This is for identification purpose only.
MAC Address	This field displays the source/destination MAC address with the VLAN identification number to which the MAC address belongs.
VID	This field displays the VLAN identification number.
Action	This field displays the filtering action ( <b>Discard both</b> , <b>Discard source</b> or <b>Discard dest.</b> ).
Delete	Check the rule(s) that you want to remove in the <b>Delete</b> column and then click the <b>Delete</b> button.
Cancel	Click <b>Cancel</b> to clear the selected checkbox(es) in the <b>Delete</b> column.

# CHAPTER 11

## Spanning Tree Protocol

The switch supports Spanning Tree Protocol (STP) and Rapid Spanning Tree Protocol (RSTP) as defined in the following standards.

- IEEE 802.1D Spanning Tree Protocol
- IEEE 802.1w Rapid Spanning Tree Protocol

The switch also allows you to set up multiple STP configurations (or trees). Ports can then be assigned to the trees.

### 11.1 STP/RSTP Overview

(R)STP detects and breaks network loops and provides backup links between switches, bridges or routers. It allows a switch to interact with other (R)STP -compliant switches in your network to ensure that only one path exists between any two stations on the network.

The switch uses IEEE 802.1w RSTP (Rapid Spanning Tree Protocol) that allows faster convergence of the spanning tree than STP (while also being backwards compatible with STP-only aware bridges). In RSTP, topology change information is directly propagated throughout the network from the device that generates the topology change. In STP, a longer delay is required as the device that causes a topology change first notifies the root bridge that then notifies the network. Both RSTP and STP flush unwanted learned addresses from the filtering database. In RSTP, the port states are Discarding, Learning, and Forwarding.

**Note:** In this user's guide, "STP" refers to both STP and RSTP.

#### 11.1.1 STP Terminology

The root bridge is the base of the spanning tree; it is the bridge with the lowest identifier value (MAC address).

Path cost is the cost of transmitting a frame onto a LAN through that port. It is assigned according to the speed of the link to which a port is attached. The slower the media, the higher the cost.

**Table 23** STP Path Costs

	LINK SPEED	RECOMMENDED VALUE	RECOMMENDED RANGE	ALLOWED RANGE
Path Cost	4Mbps	250	100 to 1000	1 to 65535
Path Cost	10Mbps	100	50 to 600	1 to 65535

**Table 23** STP Path Costs

	LINK SPEED	RECOMMENDED VALUE	RECOMMENDED RANGE	ALLOWED RANGE
Path Cost	16Mbps	62	40 to 400	1 to 65535
Path Cost	100Mbps	19	10 to 60	1 to 65535
Path Cost	1Gbps	4	3 to 10	1 to 65535
Path Cost	10Gbps	2	1 to 5	1 to 65535

On each bridge, the root port is the port through which this bridge communicates with the root. It is the port on this switch with the lowest path cost to the root (the root path cost). If there is no root port, then this switch has been accepted as the root bridge of the spanning tree network.

For each LAN segment, a designated bridge is selected. This bridge has the lowest cost to the root among the bridges connected to the LAN.

### 11.1.2 How STP Works

After a bridge determines the lowest cost-spanning tree with STP, it enables the root port and the ports that are the designated ports for connected LANs, and disables all other ports that participate in STP. Network packets are therefore only forwarded between enabled ports, eliminating any possible network loops.

STP-aware switches exchange Bridge Protocol Data Units (BPDUs) periodically. When the bridged LAN topology changes, a new spanning tree is constructed.

Once a stable network topology has been established, all bridges listen for Hello BPDUs (Bridge Protocol Data Units) transmitted from the root bridge. If a bridge does not get a Hello BPDUs after a predefined interval (Max Age), the bridge assumes that the link to the root bridge is down. This bridge then initiates negotiations with other bridges to reconfigure the network to re-establish a valid network topology.

### 11.1.3 STP Port States

STP assigns five port states to eliminate packet looping. A bridge port is not allowed to go directly from blocking state to forwarding state so as to eliminate transient loops.

**Table 24** STP Port States

PORT STATE	DESCRIPTION
Disabled	STP is disabled (default).
Blocking	Only configuration and management BPDUs are received and processed.
Listening	All BPDUs are received and processed.

**Table 24** STP Port States

PORT STATE	DESCRIPTION
Learning	All BPDUs are received and processed. Information frames are submitted to the learning process but not forwarded.
Forwarding	All BPDUs are received and processed. All information frames are received and forwarded.

### 11.1.4 Multiple RSTP

MRSTP (Multiple RSTP) is ZyXEL's proprietary feature that is compatible with RSTP and STP. With MRSTP, you can have more than one spanning tree on your switch and assign port(s) to each tree. Each spanning tree operates independently with its own bridge information.

In the following example, there are two RSTP instances (**MRSTP 1** and **MRSTP2**) on switch **A**.

To set up MRSTP, activate MRSTP on the switch and specify which port(s) belong to which spanning tree.

**Note:** Each port can belong to one STP tree only.

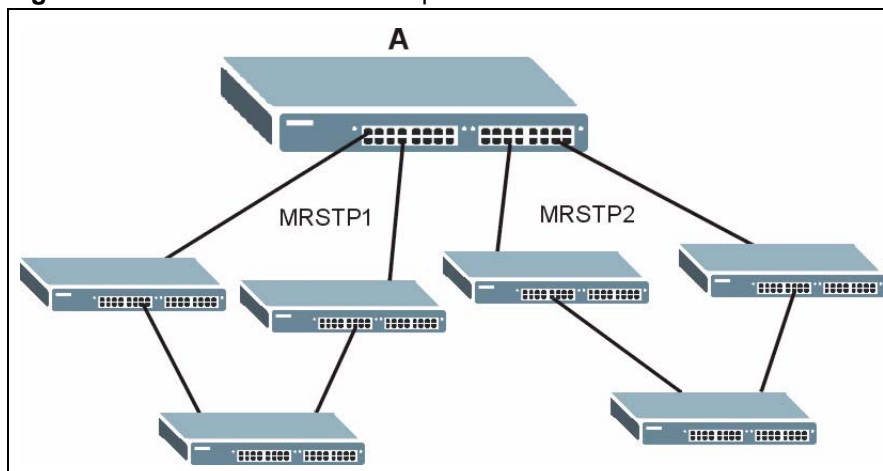
**Figure 45** MRSTP Network Example

## 11.2 Spanning Tree Protocol Main Screen

The switch allows you to configure a single RSTP configuration or you can configure multiple configurations. Click **Advanced Application, Spanning Tree Protocol** in the navigation panel to choose whether you want to configure multiple or a single Spanning Tree Protocol configuration.

**Note:** This screen is only available if neither RSTP or MRSTP is active. Once you select RSTP or MRSTP this screen displays the status of your configuration.

**Figure 46** Spanning Tree Protocol RSTP and MRSTP

The following table describes the labels in this screen.

**Table 25** Spanning Tree Protocol: Status

LABEL	DESCRIPTION
RSTP	This link takes you to the Rapid Spanning Tree Protocol configuration screen. See <a href="#">Section 11.3 on page 110</a> .
MRSTP	This link takes you to the Multiple Rapid Spanning Tree Protocol configuration screen. See <a href="#">Section 11.3 on page 110</a> .

## 11.3 Configure Rapid Spanning Tree Protocol

Use this screen to configure RSTP settings, see [Section 11.1 on page 107](#) for more information on RSTP. Click **RSTP** in the **Advanced Application, Spanning Tree Protocol** screen.

**Figure 47** RSTP: Configuration

Port	Active	Priority	Path Cost
*	<input type="checkbox"/>		
1	<input type="checkbox"/>	128	19
2	<input type="checkbox"/>	128	19
3	<input type="checkbox"/>	128	19
45	<input type="checkbox"/>	128	19
46	<input type="checkbox"/>	128	19
47	<input type="checkbox"/>	128	19
48	<input type="checkbox"/>	128	19
49	<input type="checkbox"/>	128	4
50	<input type="checkbox"/>	128	4
51	<input type="checkbox"/>	128	4
52	<input type="checkbox"/>	128	4

The following table describes the labels in this screen.

**Table 26** RSTP: Configuration

LABEL	DESCRIPTION
Status	Click <b>Status</b> to display the <b>RSTP Status</b> screen (see <a href="#">Figure 48 on page 113</a> ).
Active	Select this check box to activate RSTP. Clear this checkbox to disable RSTP.
Bridge Priority	<p>Bridge priority is used in determining the root switch, root port and designated port. The switch with the highest priority (lowest numeric value) becomes the STP root switch. If all switches have the same priority, the switch with the lowest MAC address will then become the root switch. Select a value from the drop-down list box.</p> <p>The lower the numeric value you assign, the higher the priority for this bridge.</p> <p>Bridge Priority determines the root bridge, which in turn determines Hello Time, Max Age and Forwarding Delay.</p>

**Table 26** RSTP: Configuration (continued)

LABEL	DESCRIPTION
Hello Time	This is the time interval in seconds between BPDU (Bridge Protocol Data Units) configuration message generations by the root switch. The allowed range is 1 to 10 seconds.
Max Age	This is the maximum time (in seconds) a switch can wait without receiving a BPDU before attempting to reconfigure. All switch ports (except for designated ports) should receive BPDUs at regular intervals. Any port that ages out STP information (provided in the last BPDU) becomes the designated port for the attached LAN. If it is a root port, a new root port is selected from among the switch ports attached to the network. The allowed range is 6 to 40 seconds.
Forwarding Delay	<p>This is the maximum time (in seconds) a switch will wait before changing states. This delay is required because every switch must receive information about topology changes before it starts to forward frames. In addition, each port needs time to listen for conflicting information that would make it return to a blocking state; otherwise, temporary data loops might result. The allowed range is 4 to 30 seconds.</p> <p>As a general rule:</p> <p><b>Note:</b> <math>2 * (\text{Forward Delay} - 1) \geq \text{Max Age} \geq 2 * (\text{Hello Time} + 1)</math></p>
Port	This field displays the port number.
*	<p>Settings in this row apply to all ports.</p> <p>Use this row only if you want to make some settings the same for all ports. Use this row first to set the common settings and then make adjustments on a port-by-port basis.</p> <p><b>Note:</b> Changes in this row are copied to all the ports as soon as you make them.</p>
Active	Select this check box to activate RSTP on this port.
Priority	<p>Configure the priority for each port here.</p> <p>Priority decides which port should be disabled when more than one port forms a loop in a switch. Ports with a higher priority numeric value are disabled first. The allowed range is between 0 and 255 and the default value is 128.</p>
Path Cost	Path cost is the cost of transmitting a frame on to a LAN through that port. It is assigned according to the speed of the bridge. The slower the media, the higher the cost-see <a href="#">Table 23 on page 107</a> for more information.
Apply	Click <b>Apply</b> to save your changes to the switch's run-time memory. The switch loses these changes if it is turned off or loses power, so use the <b>Save</b> link on the top navigation panel to save your changes to the non-volatile memory when you are done configuring.
Cancel	Click <b>Cancel</b> to reset the fields.

## 11.4 Rapid Spanning Tree Protocol Status

Click **Advanced Application, Spanning Tree Protocol** in the navigation panel to display the status screen as shown next. See [Section 11.1 on page 107](#) for more information on RSTP.

**Note:** This screen is only available after you activate RSTP on the switch.



**Figure 48** Rapid Spanning Tree Protocol: Status

Rapid Spanning Tree Protocol Status			<a href="#">Configuration</a>
Rapid Spanning Tree Protocol: Running			
	Bridge	Root	Our Bridge
	Bridge ID	8000-0013496ad187	8000-0013496ad187
	Hello Time (second)	2	2
	Max Age (second)	20	20
	Forwarding Delay (second)	15	15
	Cost to Bridge	0	
	Port ID	0X0000	
	Topology Changed Times	0	
	Time Since Last Change	0:00:11	

The following table describes the labels in this screen.

**Table 27** Rapid Spanning Tree Protocol: Status

LABEL	DESCRIPTION
Configuration	Click <b>Configuration</b> to configure RSTP settings. Refer to <a href="#">Section 11.3 on page 110</a> .
Bridge	<b>Root</b> refers to the base of the spanning tree (the root bridge). <b>Our Bridge</b> is this switch. This switch may also be the root bridge.
Bridge ID	This is the unique identifier for this bridge, consisting of bridge priority plus MAC address. This ID is the same for <b>Root</b> and <b>Our Bridge</b> if the switch is the root switch.
Hello Time (second)	This is the time interval (in seconds) at which the root switch transmits a configuration message. The root bridge determines <b>Hello Time</b> , <b>Max Age</b> and <b>Forwarding Delay</b> .
Max Age (second)	This is the maximum time (in seconds) a switch can wait without receiving a configuration message before attempting to reconfigure.
Forwarding Delay (second)	This is the time (in seconds) the root switch will wait before changing states (that is, listening to learning to forwarding).
Cost to Bridge	This is the path cost from the root port on this switch to the root switch.
Port ID	This is the priority and number of the port on the switch through which this switch must communicate with the root of the Spanning Tree.
Topology Changed Times	This is the number of times the spanning tree has been reconfigured.
Time Since Last Change	This is the time since the spanning tree was last reconfigured.

## 11.5 Configure Multiple Rapid Spanning Tree Protocol

To configure MRSTP, select **MRSTP** in the **Advanced Application, Spanning Tree Protocol** screen. See [Section 11.1 on page 107](#) for more information on MRSTP.

**Figure 49** MRSTP: Configuration

Tree	Active	Bridge Priority	Hello Time	MAX Age	Forwarding Delay
1	<input type="checkbox"/>	32768	2 seconds	20 seconds	15
2	<input type="checkbox"/>	32768	2 seconds	20 seconds	15

Port	Active	Priority	Path Cost	Tree
*	<input type="checkbox"/>			1
1	<input type="checkbox"/>	128	19	1
2	<input type="checkbox"/>	128	19	1
3	<input type="checkbox"/>	128	19	1
45	<input type="checkbox"/>	128	19	1
46	<input type="checkbox"/>	128	19	1
47	<input type="checkbox"/>	128	19	1
48	<input type="checkbox"/>	128	19	1
49	<input type="checkbox"/>	128	4	1
50	<input type="checkbox"/>	128	4	1
51	<input type="checkbox"/>	128	4	1
52	<input type="checkbox"/>	128	4	1

Apply Cancel

The following table describes the labels in this screen.

**Table 28** MRSTP: Configuration

LABEL	DESCRIPTION
Status	Click <b>Status</b> to display the <b>MRSTP Status</b> screen (see <a href="#">Figure 48 on page 113</a> ).
Tree	This is a read only index number of the STP trees.
Active	Select this check box to activate an STP tree. Clear this checkbox to disable an STP tree.
Bridge Priority	<p>Bridge priority is used in determining the root switch, root port and designated port. The switch with the highest priority (lowest numeric value) becomes the STP root switch. If all switches have the same priority, the switch with the lowest MAC address will then become the root switch. Select a value from the drop-down list box.</p> <p>The lower the numeric value you assign, the higher the priority for this bridge.</p> <p>Bridge Priority determines the root bridge, which in turn determines Hello Time, Max Age and Forwarding Delay.</p>
Hello Time	This is the time interval in seconds between BPDU (Bridge Protocol Data Units) configuration message generations by the root switch. The allowed range is 1 to 10 seconds.

**Table 28** MRSTP: Configuration (continued)

LABEL	DESCRIPTION
Max Age	This is the maximum time (in seconds) a switch can wait without receiving a BPDU before attempting to reconfigure. All switch ports (except for designated ports) should receive BPDUs at regular intervals. Any port that ages out STP information (provided in the last BPDU) becomes the designated port for the attached LAN. If it is a root port, a new root port is selected from among the switch ports attached to the network. The allowed range is 6 to 40 seconds.
Forwarding Delay	This is the maximum time (in seconds) a switch will wait before changing states. This delay is required because every switch must receive information about topology changes before it starts to forward frames. In addition, each port needs time to listen for conflicting information that would make it return to a blocking state; otherwise, temporary data loops might result. The allowed range is 4 to 30 seconds.  As a general rule:  <b>Note:</b> $2 * (\text{Forward Delay} - 1) \geq \text{Max Age} \geq 2 * (\text{Hello Time} + 1)$
Port	This field displays the port number.
*	Settings in this row apply to all ports.  Use this row only if you want to make some settings the same for all ports. Use this row first to set the common settings and then make adjustments on a port-by-port basis.  <b>Note:</b> Changes in this row are copied to all the ports as soon as you make them.
Active	Select this check box to activate STP on this port.
Priority	Configure the priority for each port here.  Priority decides which port should be disabled when more than one port forms a loop in a switch. Ports with a higher priority numeric value are disabled first. The allowed range is between 0 and 255 and the default value is 128.
Path Cost	Path cost is the cost of transmitting a frame on to a LAN through that port. It is assigned according to the speed of the bridge. The slower the media, the higher the cost-see <a href="#">Table 23 on page 107</a> for more information.
Tree	Select which STP tree configuration this port should participate in.
Apply	Click <b>Apply</b> to save your changes to the switch's run-time memory. The switch loses these changes if it is turned off or loses power, so use the <b>Save</b> link on the top navigation panel to save your changes to the non-volatile memory when you are done configuring.
Cancel	Click <b>Cancel</b> to reset the fields.

## 11.6 Multiple Rapid Spanning Tree Protocol Status

Click **Advanced Application, Spanning Tree Protocol** in the navigation panel to display the status screen as shown next. See [Section 11.1 on page 107](#) for more information on MRSTP.

**Note:** This screen is only available after you activate MRSTP on the switch.

**Figure 50** MRSTP: Status

Bridge	Root	Our Bridge
Bridge ID	8000-0013496ad187	8000-0013496ad187
Hello Time (second)	2	2
Max Age (second)	20	20
Forwarding Delay (second)	15	15
Cost to Bridge	0	
Port ID	0X0000	
Topology Changed Times		0
Time Since Last Change		0:00:11

The following table describes the labels in this screen.

**Table 29** Spanning Tree Protocol: Status

LABEL	DESCRIPTION
Configuration	Click <b>Configuration</b> to configure MRSTP settings. Refer to <a href="#">Section 11.3 on page 110</a> .
Tree	Select which STP tree configuration you want to view.
Bridge	<b>Root</b> refers to the base of the spanning tree (the root bridge). <b>Our Bridge</b> is this switch. This switch may also be the root bridge.
Bridge ID	This is the unique identifier for this bridge, consisting of bridge priority plus MAC address. This ID is the same for <b>Root</b> and <b>Our Bridge</b> if the switch is the root switch.
Hello Time (second)	This is the time interval (in seconds) at which the root switch transmits a configuration message. The root bridge determines <b>Hello Time</b> , <b>Max Age</b> and <b>Forwarding Delay</b> .
Max Age (second)	This is the maximum time (in seconds) a switch can wait without receiving a configuration message before attempting to reconfigure.
Forwarding Delay (second)	This is the time (in seconds) the root switch will wait before changing states (that is, listening to learning to forwarding).
Cost to Bridge	This is the path cost from the root port on this switch to the root switch.
Port ID	This is the priority and number of the port on the switch through which this switch must communicate with the root of the Spanning Tree.
Topology Changed Times	This is the number of times the spanning tree has been reconfigured.
Time Since Last Change	This is the time since the spanning tree was last reconfigured.

# CHAPTER 12

## Bandwidth Control

This chapter shows you how you can cap the maximum bandwidth using the **Bandwidth Control** screen.

### 12.1 Bandwidth Control Overview

Bandwidth control means defining a maximum allowable bandwidth for incoming and/or outgoing traffic flows on a port.

#### 12.1.1 CIR and PIR

The Committed Information Rate (CIR) is the guaranteed bandwidth for the incoming traffic flow on a port. The Peak Information Rate (PIR) is the maximum bandwidth allowed for the incoming traffic flow on a port when there is no network congestion.

The CIR and PIR should be set for all ports that use the same uplink bandwidth. If the CIR is reached, packets are sent at the rate up to the PIR. When network congestion occurs, packets through the ingress port exceeding the CIR will be marked for drop.

**Note:** The CIR should be less than the PIR.

The sum of CIRs cannot be greater than or equal to the uplink bandwidth.

### 12.2 Bandwidth Control Setup

Click **Advanced Application** and then **Bandwidth Control** in the navigation panel to bring up the screen as shown next.

**Figure 51** Bandwidth Control

Port	Active	Commit Rate	Ingress Rate Active	Peak Rate	Active	Egress Rate
*	<input type="checkbox"/>	<input type="text"/> Kbps	<input type="checkbox"/>	<input type="text"/> Kbps	<input type="checkbox"/>	<input type="text"/> Kbps
1	<input type="checkbox"/>	<input type="text"/> Kbps	<input type="checkbox"/>	<input type="text"/> Kbps	<input type="checkbox"/>	<input type="text"/> Kbps
2	<input type="checkbox"/>	<input type="text"/> Kbps	<input type="checkbox"/>	<input type="text"/> Kbps	<input type="checkbox"/>	<input type="text"/> Kbps
3	<input type="checkbox"/>	<input type="text"/> Kbps	<input type="checkbox"/>	<input type="text"/> Kbps	<input type="checkbox"/>	<input type="text"/> Kbps
45	<input type="checkbox"/>	<input type="text"/> Kbps	<input type="checkbox"/>	<input type="text"/> Kbps	<input type="checkbox"/>	<input type="text"/> Kbps
46	<input type="checkbox"/>	<input type="text"/> Kbps	<input type="checkbox"/>	<input type="text"/> Kbps	<input type="checkbox"/>	<input type="text"/> Kbps
47	<input type="checkbox"/>	<input type="text"/> Kbps	<input type="checkbox"/>	<input type="text"/> Kbps	<input type="checkbox"/>	<input type="text"/> Kbps
48	<input type="checkbox"/>	<input type="text"/> Kbps	<input type="checkbox"/>	<input type="text"/> Kbps	<input type="checkbox"/>	<input type="text"/> Kbps
49	<input type="checkbox"/>	<input type="text"/> Kbps	<input type="checkbox"/>	<input type="text"/> Kbps	<input type="checkbox"/>	<input type="text"/> Kbps
50	<input type="checkbox"/>	<input type="text"/> Kbps	<input type="checkbox"/>	<input type="text"/> Kbps	<input type="checkbox"/>	<input type="text"/> Kbps
51	<input type="checkbox"/>	<input type="text"/> Kbps	<input type="checkbox"/>	<input type="text"/> Kbps	<input type="checkbox"/>	<input type="text"/> Kbps
52	<input type="checkbox"/>	<input type="text"/> Kbps	<input type="checkbox"/>	<input type="text"/> Kbps	<input type="checkbox"/>	<input type="text"/> Kbps

The following table describes the related labels in this screen.

**Table 30** Bandwidth Control

LABEL	DESCRIPTION
Active	Select this check box to enable bandwidth control on the switch.
Port	This field displays the port number.
*	Settings in this row apply to all ports. Use this row only if you want to make some settings the same for all ports. Use this row first to set the common settings and then make adjustments on a port-by-port basis.  <b>Note:</b> Changes in this row are copied to all the ports as soon as you make them.
Ingress Rate	
Active	Select this check box to activate commit rate limits on this port.
Commit Rate	Specify the guaranteed bandwidth allowed in kilobits per second (Kbps) for the incoming traffic flow on a port. The commit rate should be less than the peak rate. The sum of commit rates cannot be greater than or equal to the uplink bandwidth.
Active	Select this check box to activate peak rate limits on this port.
Peak Rate	Specify the maximum bandwidth allowed in kilobits per second (Kbps) for the incoming traffic flow on a port.
Active	Select this check box to activate egress rate limits on this port.
Egress Rate	Specify the maximum bandwidth allowed in kilobits per second (Kbps) for the out-going traffic flow on a port.

**Table 30** Bandwidth Control (continued)

LABEL	DESCRIPTION
Apply	Click <b>Apply</b> to save your changes to the switch's run-time memory. The switch loses these changes if it is turned off or loses power, so use the <b>Save</b> link on the top navigation panel to save your changes to the non-volatile memory when you are done configuring.
Cancel	Click <b>Cancel</b> to reset the fields.





# CHAPTER 13

## Broadcast Storm Control

This chapter introduces and shows you how to configure the broadcast storm control feature.

### 13.1 Broadcast Storm Control Setup

Broadcast storm control limits the number of broadcast, multicast and destination lookup failure (DLF) packets the switch receives per second on the ports. When the maximum number of allowable broadcast, multicast and/or DLF packets is reached per second, the subsequent packets are discarded. Enable this feature to reduce broadcast, multicast and/or DLF packets in your network. You can specify limits for each packet type on each port.

Click **Advanced Application, Broadcast Storm Control** in the navigation panel to display the screen as shown next.

**Figure 52** Broadcast Storm Control

Port	Broadcast (pkt/s)	Multicast (pkt/s)	DLF (pkt/s)
*	<input type="checkbox"/> <input type="text"/>	<input type="checkbox"/> <input type="text"/>	<input type="checkbox"/> <input type="text"/>
1	<input type="checkbox"/> 0	<input type="checkbox"/> 0	<input type="checkbox"/> 0
2	<input type="checkbox"/> 0	<input type="checkbox"/> 0	<input type="checkbox"/> 0
3	<input type="checkbox"/> 0	<input type="checkbox"/> 0	<input type="checkbox"/> 0
45	<input type="checkbox"/> 0	<input type="checkbox"/> 0	<input type="checkbox"/> 0
46	<input type="checkbox"/> 0	<input type="checkbox"/> 0	<input type="checkbox"/> 0
47	<input type="checkbox"/> 0	<input type="checkbox"/> 0	<input type="checkbox"/> 0
48	<input type="checkbox"/> 0	<input type="checkbox"/> 0	<input type="checkbox"/> 0
49	<input type="checkbox"/> 0	<input type="checkbox"/> 0	<input type="checkbox"/> 0
50	<input type="checkbox"/> 0	<input type="checkbox"/> 0	<input type="checkbox"/> 0
51	<input type="checkbox"/> 0	<input type="checkbox"/> 0	<input type="checkbox"/> 0
52	<input type="checkbox"/> 0	<input type="checkbox"/> 0	<input type="checkbox"/> 0

Apply Cancel

The following table describes the labels in this screen.

**Table 31** Broadcast Storm Control

LABEL	DESCRIPTION
Active	Select this check box to enable traffic storm control on the switch. Clear this check box to disable this feature.
Port	This field displays a port number.
*	Settings in this row apply to all ports. Use this row only if you want to make some settings the same for all ports. Use this row first to set the common settings and then make adjustments on a port-by-port basis.  <b>Note:</b> Changes in this row are copied to all the ports as soon as you make them.
Broadcast (pkt/s)	Select this option and specify how many broadcast packets the port receives per second.
Multicast (pkt/s)	Select this option and specify how many multicast packets the port receives per second.
DLF (pkt/s)	Select this option and specify how many destination lookup failure (DLF) packets the port receives per second.
Apply	Click <b>Apply</b> to save your changes to the switch's run-time memory. The switch loses these changes if it is turned off or loses power, so use the <b>Save</b> link on the top navigation panel to save your changes to the non-volatile memory when you are done configuring.
Cancel	Click <b>Cancel</b> to reset the fields.

# CHAPTER 14

## Mirroring

This chapter discusses the Mirror setup screens.

### 14.1 Port Mirroring Setup

Port mirroring allows you to copy a traffic flow to a monitor port (the port you copy the traffic to) in order that you can examine the traffic from the monitor port without interference.

Click **Advanced Application, Mirroring** in the navigation panel to display the **Mirroring** screen. Use this screen to select a monitor port and specify the traffic flow to be copied to the monitor port.

**Figure 53** Mirroring

Port	Mirrored	Direction
*	<input type="checkbox"/>	Ingress
1	<input type="checkbox"/>	Ingress
2	<input type="checkbox"/>	Ingress
3	<input type="checkbox"/>	Ingress
45	<input type="checkbox"/>	Ingress
46	<input type="checkbox"/>	Ingress
47	<input type="checkbox"/>	Ingress
48	<input type="checkbox"/>	Ingress
49	<input type="checkbox"/>	Ingress
50	<input type="checkbox"/>	Ingress
51	<input type="checkbox"/>	Ingress
52	<input type="checkbox"/>	Ingress

Apply Cancel

The following table describes the labels in this screen.

**Table 32** Mirroring

LABEL	DESCRIPTION
Active	Select this check box to activate port mirroring on the switch. Clear this check box to disable the feature.
Monitor Port	The monitor port is the port you copy the traffic to in order to examine it in more detail without interfering with the traffic flow on the original port(s). Enter the port number of the monitor port.
Port	This field displays the port number.
*	Settings in this row apply to all ports. Use this row only if you want to make some settings the same for all ports. Use this row first to set the common settings and then make adjustments on a port-by-port basis.  <b>Note:</b> Changes in this row are copied to all the ports as soon as you make them.
Mirrored	Select this option to mirror the traffic on a port.
Direction	Specify the direction of the traffic to mirror by selecting from the drop-down list box. Choices are <b>Egress</b> (outgoing), <b>Ingress</b> (incoming) and <b>Both</b> .
Apply	Click <b>Apply</b> to save your changes to the switch's run-time memory. The switch loses these changes if it is turned off or loses power, so use the <b>Save</b> link on the top navigation panel to save your changes to the non-volatile memory when you are done configuring.
Cancel	Click <b>Cancel</b> to reset the fields.

# CHAPTER 15

## Link Aggregation

This chapter shows you how to logically aggregate physical links to form one logical, higher-bandwidth link.

### 15.1 Link Aggregation Overview

Link aggregation (trunking) is the grouping of physical ports into one logical higher-capacity link. You may want to trunk ports if for example, it is cheaper to use multiple lower-speed links than to under-utilize a high-speed, but more costly, single-port link.

However, the more ports you aggregate then the fewer available ports you have. A trunk group is one logical link containing multiple ports.

The beginning port of each trunk group must be physically connected to form a trunk group.

### 15.2 Dynamic Link Aggregation

The switch adheres to the IEEE 802.3ad standard for static and dynamic (LACP) port trunking.

The switch supports the link aggregation IEEE802.3ad standard. This standard describes the Link Aggregate Control Protocol (LACP), which is a protocol that dynamically creates and manages trunk groups.

When you enable LACP link aggregation on a port, the port can automatically negotiate with the ports at the remote end of a link to establish trunk groups. LACP also allows port redundancy, that is, if an operational port fails, then one of the “standby” ports become operational without user intervention. Please note that:

- You must connect all ports point-to-point to the same Ethernet switch and configure the ports for LACP trunking.
- LACP only works on full-duplex links.
- All ports in the same trunk group must have the same media type, speed, duplex mode and flow control settings.

Configure trunk groups or LACP before you connect the Ethernet switch to avoid causing network topology loops.

## 15.2.1 Link Aggregation ID

LACP aggregation ID consists of the following information<sup>1</sup>:

**Table 33** Link Aggregation ID: Local Switch

SYSTEM PRIORITY	MAC ADDRESS	KEY	PORT PRIORITY	PORT NUMBER
0000	00-00-00-00-00	0000	00	0000

**Table 34** Link Aggregation ID: Peer Switch

SYSTEM PRIORITY	MAC ADDRESS	KEY	PORT PRIORITY	PORT NUMBER
0000	00-00-00-00-00	0000	00	0000

## 15.3 Link Aggregation Control Protocol Status

Click **Advanced Application**, **Link Aggregation** in the navigation panel. The **Link Aggregation Control Protocol Status** screen displays by default. See [Section 15.1 on page 125](#) for more information.

**Figure 54** Link Aggregation Control Protocol Status

Index	Aggregator ID	Enabled Ports	Synchronized Ports
1	[(0000,00-00-00-00-00-00,0000,00,0000)] [(0000,00-00-00-00-00-00,0000,00,0000)]	-	-
2	[(0000,00-00-00-00-00-00,0000,00,0000)] [(0000,00-00-00-00-00-00,0000,00,0000)]	-	-
3	[(0000,00-00-00-00-00-00,0000,00,0000)] [(0000,00-00-00-00-00-00,0000,00,0000)]	-	-
4	[(0000,00-00-00-00-00-00,0000,00,0000)] [(0000,00-00-00-00-00-00,0000,00,0000)]	-	-
5	[(0000,00-00-00-00-00-00,0000,00,0000)] [(0000,00-00-00-00-00-00,0000,00,0000)]	-	-
6	[(0000,00-00-00-00-00-00,0000,00,0000)] [(0000,00-00-00-00-00-00,0000,00,0000)]	-	-

1. Port Priority and Port Number are 0 as it is the aggregator ID for the trunk group, not the individual port.

The following table describes the labels in this screen.

**Table 35** Link Aggregation Control Protocol Status

LABEL	DESCRIPTION
Index	This field displays the trunk ID to identify a trunk group, that is, one logical link containing multiple ports.
Aggregator ID	Link Aggregator ID consists of the following: system priority, MAC address, key, port priority and port number. Refer to <a href="#">Section 15.2.1 on page 126</a> for more information on this field.
Enabled Port	These are the ports you have configured in the <b>Link Aggregation</b> screen to be in the trunk group.
Synchronized Ports	These are the ports that are currently transmitting data as one logical link in this trunk group.

## 15.4 Link Aggregation Setup

Click **Configuration** in the **Link Aggregation Control Protocol Status** screen to display the screen shown next. See [Section 15.1 on page 125](#) for more information on link aggregation.

**Figure 55** Link Aggregation: Configuration

**Link Aggregation**
Status

**Link Aggregation Control Protocol**

Active

System Priority

---

Group ID	Active	Dynamic(LACP)
T1	<input type="checkbox"/>	<input type="checkbox"/>
T2	<input type="checkbox"/>	<input type="checkbox"/>
T3	<input type="checkbox"/>	<input type="checkbox"/>
T4	<input type="checkbox"/>	<input type="checkbox"/>
T5	<input type="checkbox"/>	<input type="checkbox"/>
T6	<input type="checkbox"/>	<input type="checkbox"/>

---

Port	Group	LACP Timeout
*	-	30 seconds
1	None	30 seconds
2	None	30 seconds
3	None	30 seconds
45	None	30 seconds
46	None	30 seconds
47	None	30 seconds
48	None	30 seconds
49	None	30 seconds
50	None	30 seconds
51	None	30 seconds
52	None	30 seconds

The following table describes the labels in this screen.

**Table 36** Link Aggregation Control Protocol: Configuration

LABEL	DESCRIPTION
Link Aggregation Control Protocol	
Active	Select this checkbox to enable Link Aggregation Control Protocol (LACP).
System Priority	LACP system priority is a number between 1 and 65,535. The switch with the lowest system priority (and lowest port number if system priority is the same) becomes the LACP "server". The LACP "server" controls the operation of LACP setup. Enter a number to set the priority of an active port using Link Aggregate Control Protocol (LACP). The smaller the number, the higher the priority level.



**Table 36** Link Aggregation Control Protocol: Configuration (continued)

LABEL	DESCRIPTION
Group ID	The field identifies the link aggregation group, that is, one logical link containing multiple ports.
Active	Select this option to activate a trunk group.
Dynamic (LACP)	Select this check box to enable LACP for a trunk.
Port	This field displays the port number.
*	<p>Settings in this row apply to all ports. Use this row only if you want to make some settings the same for all ports. Use this row first to set the common settings and then make adjustments on a port-by-port basis.</p> <p><b>Note:</b> Changes in this row are copied to all the ports as soon as you make them.</p>
Group	Select the trunk group to which a port belongs.
LACP Timeout	<p>Timeout is the time interval between the individual port exchanges of LACP packets in order to check that the peer port in the trunk group is still up. If a port does not respond after three tries, then it is deemed to be “down” and is removed from the trunk. Set a short timeout (one second) for busy trunked links to ensure that disabled ports are removed from the trunk group as soon as possible.</p> <p>Select either 1 second or 30 seconds.</p>
Apply	Click <b>Apply</b> to save your changes to the switch's run-time memory. The switch loses these changes if it is turned off or loses power, so use the <b>Save</b> link on the top navigation panel to save your changes to the non-volatile memory when you are done configuring.
Cancel	Click <b>Cancel</b> to reset the fields.



# CHAPTER 16

## Port Authentication

This chapter describes the 802.1x authentication method and RADIUS server connection setup. See [Section 36.9 on page 281](#) for information on how to use the commands to configure additional Radius server settings as well as multiple Radius server configuration.

### 16.1 Port Authentication Overview

IEEE 802.1x is an extended authentication protocol<sup>2</sup> that allows support of RADIUS (Remote Authentication Dial In User Service, RFC 2138, 2139) for centralized user profile and accounting management on a network RADIUS server.

#### 16.1.1 RADIUS

RADIUS (Remote Authentication Dial-In User Service) authentication is a popular protocol used to authenticate users by means of an external server instead of (or in addition to) an internal device user database that is limited to the memory capacity of the device. In essence, RADIUS authentication allows you to validate an unlimited number of users from a central location.

**Figure 56** RADIUS Server

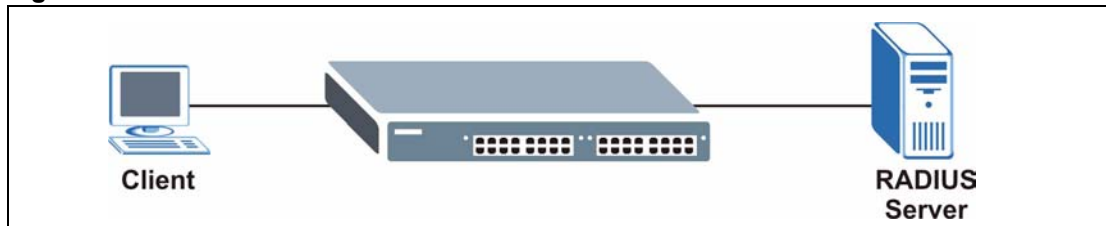

##### 16.1.1.1 Vendor Specific Attribute

A Vendor Specific Attribute (VSA) is an attribute-value pair that is sent between a RADIUS server and the ES-3148. Configure VSAs on the RADIUS server to set the ES-3148 to perform the following actions on an authenticated user:

- Limit bandwidth on incoming or outgoing traffic
- Assign account privilege levels

---

2. At the time of writing, only Windows XP of the Microsoft operating systems supports it. See the Microsoft web site for information on other Windows operating system support. For other operating systems, see its documentation. If your operating system does not support 802.1x, then you may need to install 802.1x client software.

**Note:** Refer to the documentation that comes with your RADIUS server on how to configure a VSA.

The following table describes the VSAs supported on the switch.

**Table 37** Supported VSA

FUNCTION	ATTRIBUTE
Ingress Bandwidth Assignment	Vendor-Id = <b>890</b> (ZyXEL) Vendor-Type = <b>1</b> Vendor-data = ingress rate (decimal)
Egress Bandwidth Assignment	Vendor-Id = <b>890</b> (ZyXEL) Vendor-Type = <b>2</b> Vendor-data = egress rate (decimal)
Privilege Assignment	Vendor-ID = <b>890</b> (ZyXEL) Vendor-Type = <b>3</b> Vendor-Data = " <b>shell:priv-lvl=N</b> " or Vendor-ID = <b>9</b> (CISCO) Vendor-Type = <b>1</b> (CISCO-AVPAIR) Vendor-Data = " <b>shell:priv-lvl=N</b> " where N is a privilege level (from 0 to 14).  <b>Note:</b> If you set the privilege level of a login account differently on the RADIUS server(s) and the switch, the user is assigned a privilege level from the database (RADIUS or local) the switch uses first for user authentication.

### 16.1.1.2 Tunnel Protocol Attribute

You can configure tunnel protocol attributes on the RADIUS server to assign a port on the switch to a VLAN (fixed, untagged). This will also set the port's VID. Refer to RFC 3580 for more information.

**Table 38** Supported Tunnel Protocol Attribute

FUNCTION	ATTRIBUTE
VLAN Assignment	Tunnel-Type = <b>VLAN (13)</b> Tunnel-Medium-Type = <b>802 (6)</b> Tunnel-Private-Group-ID = VLAN ID  <b>Note:</b> You must also create a VLAN with the specified VID on the switch.

## 16.2 Port Authentication Configuration

To enable port authentication, first activate IEEE802.1x security (both on the switch and the port(s)) then configure the RADIUS server settings.

Click **Advanced Application, Port Authentication** in the navigation panel to display the screen as shown.

**Figure 57** Port Authentication

## 16.2.1 Configuring RADIUS Server Settings

Use this screen to configure your RADIUS server settings. See [Section 16.1.1 on page 131](#) for more information on RADIUS servers. From the **Port Authentication** screen, click **RADIUS** to display the configuration screen as shown.

**Figure 58** Port Authentication: RADIUS

The following table describes the labels in this screen.

**Table 39** Port Authentication: RADIUS

LABEL	DESCRIPTION
Authentication Server	
IP Address	Enter the IP address of the external RADIUS server in dotted decimal notation.
UDP Port	The default port of the RADIUS server for authentication is <b>1812</b> . You need not change this value unless your network administrator instructs you to do so.
Shared Secret	Specify a password (up to 32 alphanumeric characters) as the key to be shared between the external RADIUS server and the switch. This key is not sent over the network. This key must be the same on the external RADIUS server and the switch.
Apply	Click <b>Apply</b> to save your changes to the switch's run-time memory. The switch loses these changes if it is turned off or loses power, so use the <b>Save</b> link on the top navigation panel to save your changes to the non-volatile memory when you are done configuring.
Cancel	Click <b>Cancel</b> to reset the fields.

## 16.2.2 Activate IEEE 802.1x Security

Use this screen to activate IEEE 802.1x security. From the **Port Authentication** screen, display the configuration screen as shown.

**Figure 59** Port Authentication: 802.1x

Port	Active	Reauthentication	Reauthentication Timer
*	<input type="checkbox"/>	On	seconds
1	<input type="checkbox"/>	On	3600 seconds
2	<input type="checkbox"/>	On	3600 seconds
3	<input type="checkbox"/>	On	3600 seconds
45	<input type="checkbox"/>	On	3600 seconds
46	<input type="checkbox"/>	On	3600 seconds
47	<input type="checkbox"/>	On	3600 seconds
48	<input type="checkbox"/>	On	3600 seconds
49	<input type="checkbox"/>	On	3600 seconds
50	<input type="checkbox"/>	On	3600 seconds
51	<input type="checkbox"/>	On	3600 seconds
52	<input type="checkbox"/>	On	3600 seconds

The following table describes the labels in this screen.

**Table 40** Port Authentication: 802.1x

LABEL	DESCRIPTION
Active	Select this check box to permit 802.1x authentication on the switch.  <b>Note:</b> You must first enable 802.1x authentication on the switch before configuring it on each port.
Port	This field displays a port number.

**Table 40** Port Authentication: 802.1x (continued)

LABEL	DESCRIPTION
*	<p>Settings in this row apply to all ports.</p> <p>Use this row only if you want to make some settings the same for all ports. Use this row first to set the common settings and then make adjustments on a port-by-port basis.</p> <p><b>Note:</b> Changes in this row are copied to all the ports as soon as you make them.</p>
Active	Select this checkbox to permit 802.1x authentication on this port. You must first allow 802.1x authentication on the switch before configuring it on each port.
Reauthentication	Specify if a subscriber has to periodically re-enter his or her username and password to stay connected to the port.
Reauthentication Timer	Specify how often a client has to re-enter his or her username and password to stay connected to the port.
Apply	Click <b>Apply</b> to save your changes to the switch's run-time memory. The switch loses these changes if it is turned off or loses power, so use the <b>Save</b> link on the top navigation panel to save your changes to the non-volatile memory when you are done configuring.
Cancel	Click <b>Cancel</b> to reset the fields.





# CHAPTER 17

## Port Security

This chapter shows you how to set up port security.

### 17.1 About Port Security

Port security allows only packets with dynamically learned MAC addresses and/or configured static MAC addresses to pass through a port on the switch. The switch can learn up to 16K MAC addresses in total with no limit on individual ports other than the sum cannot exceed 16K.

For maximum port security, enable this feature, disable MAC address learning and configure static MAC address(es) for a port. It is not recommended you disable port security together with MAC address learning as this will result in many broadcasts. By default, MAC address learning is still enabled even though the port security is not activated.

### 17.2 Port Security Setup

Click **Advanced Application, Port Security** in the navigation panel to display the screen as shown.

**Figure 60** Port Security

Port	Active	Address Learning	Limited Number of Learned MAC Address
*	<input type="checkbox"/>	<input checked="" type="checkbox"/>	<input type="text"/>
1	<input type="checkbox"/>	<input checked="" type="checkbox"/>	<input type="text" value="0"/>
2	<input type="checkbox"/>	<input checked="" type="checkbox"/>	<input type="text" value="0"/>
3	<input type="checkbox"/>	<input checked="" type="checkbox"/>	<input type="text" value="0"/>
45	<input type="checkbox"/>	<input checked="" type="checkbox"/>	<input type="text" value="0"/>
46	<input type="checkbox"/>	<input checked="" type="checkbox"/>	<input type="text" value="0"/>
47	<input type="checkbox"/>	<input checked="" type="checkbox"/>	<input type="text" value="0"/>
48	<input type="checkbox"/>	<input checked="" type="checkbox"/>	<input type="text" value="0"/>
49	<input type="checkbox"/>	<input checked="" type="checkbox"/>	<input type="text" value="0"/>
50	<input type="checkbox"/>	<input checked="" type="checkbox"/>	<input type="text" value="0"/>
51	<input type="checkbox"/>	<input checked="" type="checkbox"/>	<input type="text" value="0"/>
52	<input type="checkbox"/>	<input checked="" type="checkbox"/>	<input type="text" value="0"/>

The following table describes the labels in this screen.

**Table 41** Port Security

LABEL	DESCRIPTION
Active	Select this option to enable port security on the switch.
Port	This field displays a port number.
*	Settings in this row apply to all ports. Use this row only if you want to make some settings the same for all ports. Use this row first to set the common settings and then make adjustments on a port-by-port basis.  <b>Note:</b> Changes in this row are copied to all the ports as soon as you make them.
Active	Select this check box to enable the port security feature on this port. The switch forwards packets whose MAC address(es) is in the MAC address table on this port. Packets with no matching MAC address(es) are dropped. Clear this check box to disable the port security feature. The switch forwards all packets on this port.
Address Learning	MAC address learning reduces outgoing broadcast traffic. For MAC address learning to occur on a port, the port itself must be active with address learning enabled.
Limited Number of Learned MAC Address	Use this field to limit the number of (dynamic) MAC addresses that may be learned on a port. For example, if you set this field to "5" on port 2, then only the devices with these five learned MAC addresses may access port 2 at any one time. A sixth device would have to wait until one of the five learned MAC addresses aged out. MAC address aging out time can be set in the <b>Switch Setup</b> screen. The valid range is from "0" to "254". "0" means this feature is disabled.

**Table 41** Port Security (continued)

LABEL	DESCRIPTION
Apply	Click <b>Apply</b> to save your changes to the switch's run-time memory. The switch loses these changes if it is turned off or loses power, so use the <b>Save</b> link on the top navigation panel to save your changes to the non-volatile memory when you are done configuring.
Cancel	Click <b>Cancel</b> to reset the fields.



# CHAPTER 18

## Classifier

This chapter introduces and shows you how to configure the packet classifier on the switch.

### 18.1 About the Classifier and QoS

Quality of Service (QoS) refers to both a network's ability to deliver data with minimum delay, and the networking methods used to control the use of bandwidth. Without QoS, all traffic data is equally likely to be dropped when the network is congested. This can cause a reduction in network performance and make the network inadequate for time-critical application such as video-on-demand.

A classifier groups traffic into data flows according to specific criteria such as the source address, destination address, source port number, destination port number or incoming port number. For example, you can configure a classifier to select traffic from the same protocol port (such as Telnet) to form a flow.

Configure QoS on the switch to group and prioritize application traffic and fine-tune network performance. Setting up QoS involves two separate steps:

- 1 Configure classifiers to sort traffic into different flows.
- 2 Configure policy rules to define actions to be performed for a classified traffic flow (refer to [Chapter 19 on page 147](#) to configure policy rules).

### 18.2 Configuring the Classifier

Use the **Classifier** screen to define the classifiers. After you define the classifier, you can specify actions (or policy) to act upon the traffic that matches the rules. To configure policy rules, refer to [Chapter 19 on page 147](#).

Click **Advanced Application** and **Classifier** in the navigation panel to display the configuration screen as shown.

**Figure 61** Classifier

The following table describes the labels in this screen.

**Table 42** Classifier

LABEL	DESCRIPTION
Active	Select this option to enable this rule.
Name	Enter a descriptive name for this rule for identifying purposes.
Packet Format	Specify the format of the packet. Choices are <b>All</b> , <b>802.3 tagged</b> , <b>802.3 untagged</b> , <b>Ethernet II tagged</b> and <b>Ethernet II untagged</b> . A value of <b>802.3</b> indicates that the packets are formatted according to the IEEE 802.3 standards. A value of <b>Ethernet II</b> indicates that the packets are formatted according to RFC 894, Ethernet II encapsulation.

**Table 42** Classifier (continued)

LABEL	DESCRIPTION
Layer 2 Specify the fields below to configure a layer 2 classifier.	
VLAN	Select <b>Any</b> to classify traffic from any VLAN or select the second option and specify the source VLAN ID in the field provided.
Priority	Select <b>Any</b> to classify traffic from any priority level or select the second option and specify a priority level in the field provided.
Ethernet Type	Select an Ethernet type or select <b>Other</b> and enter the Ethernet type number in hexadecimal value. Refer to <a href="#">Table 44 on page 144</a> for information.
Source	
MAC Address	Select <b>Any</b> to apply the rule to all MAC addresses. To specify a source, select the second choice and type a MAC address in valid MAC address format (six hexadecimal character pairs).
Port	Type the port number to which the rule should be applied. You may choose one port only or all ports ( <b>Any</b> ).
Destination	
MAC Address	Select <b>Any</b> to apply the rule to all MAC addresses. To specify a destination, select the second choice and type a MAC address in valid MAC address format (six hexadecimal character pairs).
Layer 3 Specify the fields below to configure a layer 3 classifier.	
DSCP	Select <b>Any</b> to classify traffic from any DSCP or select the second option and specify a DSCP (DiffServ Code Point) number between 0 and 63 in the field provided.
IP Protocol	Select an IP protocol type or select <b>Other</b> and enter the protocol number in decimal value. Refer to <a href="#">Table 45 on page 145</a> for more information. You may select <b>Establish Only</b> for <b>TCP</b> protocol type. This means that the switch will pick out the packets that are sent to establish TCP connections.
Source	
IP Address/ Address Prefix	Enter a source IP address in dotted decimal notation. Specify the address prefix by entering the number of ones in the subnet mask.
Socket Number	<b>Note:</b> You must select either <b>UDP</b> or <b>TCP</b> in the <b>IP Protocol</b> field before you configure the socket numbers.  Select <b>Any</b> to apply the rule to all TCP/UDP protocol port numbers or select the second option and enter a TCP/UDP protocol port number.
Destination	
IP Address/ Address Prefix	Enter a destination IP address in dotted decimal notation. Specify the address prefix by entering the number of ones in the subnet mask.
Socket Number	<b>Note:</b> You must select either <b>UDP</b> or <b>TCP</b> in the <b>IP Protocol</b> field before you configure the socket numbers.  Select <b>Any</b> to apply the rule to all TCP/UDP protocol port numbers or select the second option and enter a TCP/UDP protocol port number.

**Table 42** Classifier (continued)

LABEL	DESCRIPTION
Add	Click <b>Add</b> to insert the entry in the summary table below.
Cancel	Click <b>Cancel</b> to reset the fields back to your previous configuration.
Clear	Click <b>Clear</b> to set the above fields back to the factory defaults.

## 18.3 Viewing and Editing Classifier Configuration

To view a summary of the classifier configuration, scroll down to the summary table at the bottom of the **Classifier** screen. To change the settings of a rule, click a number in the **Index** field.

**Note:** When two rules conflict with each other, a higher layer rule has priority over lower layer rule.

**Figure 62** Classifier: Summary Table

Index	Active	Name	Rule	Delete
1	Yes	Example	EtherType = IP; SrcMac = 00:50:ba:ad:4f:81; SrcPort = port 2;	<input type="checkbox"/>

Delete Cancel

The following table describes the labels in this screen.

**Table 43** Classifier: Summary Table

LABEL	DESCRIPTION
Index	This field displays the index number of the rule. Click an index number to edit the rule.
Active	This field displays <b>Yes</b> when the rule is activated and <b>No</b> when it is deactivated.
Name	This field displays the descriptive name for this rule. This is for identification purpose only.
Rule	This field displays a summary of the classifier rule's settings.
Delete	Click <b>Delete</b> to remove the selected entry from the summary table.
Cancel	Click <b>Cancel</b> to clear the <b>Delete</b> check boxes.

The following table shows some other common Ethernet types and the corresponding protocol number.

**Table 44** Common Ethernet Types and Protocol Number

ETHERNET TYPE	PROTOCOL NUMBER
IP ETHII	0800
X.75 Internet	0801
NBS Internet	0802
ECMA Internet	0803



**Table 44** Common Ethernet Types and Protocol Number

ETHERNET TYPE	PROTOCOL NUMBER
Chaosnet	0804
X.25 Level 3	0805
XNS Compat	0807
Banyan Systems	0BAD
BBN Simnet	5208
IBM SNA	80D5
AppleTalk AARP	80F3

Some of the most common IP ports are:

**Table 45** Common IP Ports

PORT NUMBER	PORT NAME
21	FTP
23	Telnet
25	SMTP
53	DNS
80	HTTP
110	POP3

## 18.4 Classifier Example

The following figure shows an example where you configure a classifier that identifies all traffic from MAC address 00:50:ba:ad:4f:81 on port 2.

**Figure 63** Classifier: Example

● Classifier

---

Active

Name

Packet Format

---

Layer 2

VLAN  Any

Priority  Any

Ethernet Type  IP   
 Others  (Hex)

---

Source

MAC Address  Any  
 MAC  :  :  :  :  :

Port  Any

---

Destination

MAC Address  Any  
 MAC  :  :  :  :  :

---

DSCP

Any

---

IP Protocol

All   Establish Only  
 Others  (Dec)

---

Layer 3

Source

IP Address / Address Prefix  /

Socket Number  Any

---

Destination

IP Address / Address Prefix  /

Socket Number  Any

---

# CHAPTER 19

## Policy Rule

This chapter shows you how to configure policy rules.

### 19.1 Policy Rules Overview

A classifier distinguishes traffic into flows based on the configured criteria (refer to [Chapter 18 on page 141](#) for more information). A policy rule ensures that a traffic flow gets the requested treatment in the network.

#### 19.1.1 DiffServ

DiffServ (Differentiated Services) is a class of service (CoS) model that marks packets so that they receive specific per-hop treatment at DiffServ-compliant network devices along the route based on the application types and traffic flow. Packets are marked with DiffServ Code Points (DSCPs) indicating the level of service desired. This allows the intermediary DiffServ-compliant network devices to handle the packets differently depending on the code points without the need to negotiate paths or remember state information for every flow. In addition, applications do not have to request a particular service or give advanced notice of where the traffic is going.

#### 19.1.2 DSCP and Per-Hop Behavior

DiffServ defines a new DS (Differentiated Services) field to replace the Type of Service (TOS) field in the IP header. The DS field contains a 2-bit unused field and a 6-bit DSCP field which can define up to 64 service levels. The following figure illustrates the DS field.

DSCP is backward compatible with the three precedence bits in the ToS octet so that non-DiffServ compliant, ToS-enabled network device will not conflict with the DSCP mapping.

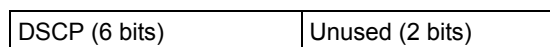

The DSCP value determines the forwarding behavior, the PHB (Per-Hop Behavior), that each packet gets across the DiffServ network. Based on the marking rule, different kinds of traffic can be marked for different kinds of forwarding. Resources can then be allocated according to the DSCP values and the configured policies.

## 19.2 Configuring Policy Rules

You must first configure a classifier in the **Classifier** screen. Refer to [Section 18.2 on page 141](#) for more information.

Click **Advanced Applications** and then **Policy Rule** in the navigation panel to display the screen as shown.

**Figure 64** Policy

Policy																																
Active	<input type="checkbox"/>																															
Name	<input type="text"/>																															
Classifier(s)	<input type="text" value="Example"/>																															
Parameters	<table border="0"> <tr> <td>VLAN ID</td> <td><input type="text"/></td> <td>General</td> <td>Bandwidth</td> <td><input type="text"/></td> <td>Kbps</td> </tr> <tr> <td>Egress Port</td> <td><input type="text"/></td> <td></td> <td>Out-of-Profile</td> <td><input type="text"/></td> </tr> <tr> <td>Outgoing packet format for Egress port</td> <td colspan="2"> <input checked="" type="radio"/> Tag <input type="radio"/> Untag                 </td> <td>DSCP</td> <td><input type="text"/></td> </tr> <tr> <td>Priority</td> <td><input type="text" value="0"/></td> <td></td> <td></td> <td></td> </tr> <tr> <td>DSCP</td> <td><input type="text"/></td> <td></td> <td></td> <td></td> </tr> <tr> <td>TOS</td> <td><input type="text" value="0"/></td> <td></td> <td></td> <td></td> </tr> </table>	VLAN ID	<input type="text"/>	General	Bandwidth	<input type="text"/>	Kbps	Egress Port	<input type="text"/>		Out-of-Profile	<input type="text"/>	Outgoing packet format for Egress port	<input checked="" type="radio"/> Tag <input type="radio"/> Untag		DSCP	<input type="text"/>	Priority	<input type="text" value="0"/>				DSCP	<input type="text"/>				TOS	<input type="text" value="0"/>			
	VLAN ID	<input type="text"/>	General	Bandwidth	<input type="text"/>	Kbps																										
	Egress Port	<input type="text"/>		Out-of-Profile	<input type="text"/>																											
	Outgoing packet format for Egress port	<input checked="" type="radio"/> Tag <input type="radio"/> Untag		DSCP	<input type="text"/>																											
	Priority	<input type="text" value="0"/>																														
	DSCP	<input type="text"/>																														
TOS	<input type="text" value="0"/>																															
Action	Forwarding																															
	<input checked="" type="radio"/> No change																															
	<input type="radio"/> Discard the packet																															
	<input type="radio"/> Do not drop the matching frame previously marked for dropping																															
	Priority																															
	<input checked="" type="radio"/> No change																															
	<input type="radio"/> Set the packet's 802.1 priority																															
	<input type="radio"/> Send the packet to priority queue																															
	<input type="radio"/> Replace the 802.1 priority field with the IP TOS value																															
	Diffserv																															
	<input checked="" type="radio"/> No change																															
	<input type="radio"/> Set the packet's TOS field																															
	<input type="radio"/> Replace the IP TOS field with the 802.1 priority value																															
<input type="radio"/> Set the Diffserv Codepoint field in the frame																																
Outgoing																																
<input type="checkbox"/> Send the packet to the mirror port																																
<input type="checkbox"/> Send the packet to the egress port																																
<input type="checkbox"/> Send the matching frames(broadcast or DLF, multicast, marked for dropping or to be sent to the CPU) to the egress port																																
<input type="checkbox"/> Set the packet's VLAN ID																																
Metering																																
<input type="checkbox"/> Enable																																
Out-of-profile action																																
<input type="checkbox"/> Drop the packet																																
<input type="checkbox"/> Change the DSCP value																																
<input type="checkbox"/> Set Out-Drop Precedence																																
<input type="checkbox"/> Do not drop the matching frame previously marked for dropping																																
<input type="button" value="Add"/> <input type="button" value="Cancel"/> <input type="button" value="Clear"/>																																

The following table describes the labels in this screen.

**Table 46** Policy

LABEL	DESCRIPTION
Active	Select this option to enable the policy.
Name	Enter a descriptive name for identification purposes.
Classifier(s)	This field displays the active classifier(s) you configure in the <b>Classifier</b> screen. Select the classifier(s) to which this policy rule applies. To select more than one classifier, press [SHIFT] and select the choices at the same time.
<b>Parameters</b> Set the fields below for this policy. You only have to set the field(s) that is related to the action(s) you configure in the <b>Action</b> field.	
<b>General</b>	
VLAN ID	Specify a VLAN ID number.
Egress Port	Type the number of an outgoing port.
Outgoing packet format for Egress port	Select <b>Tag</b> to add the specified VID to packets on the specified outgoing port. Otherwise, select <b>Untag</b> .
Priority	Specify a priority level.
DSCP	Specify a DSCP (DiffServ Code Point) number between 0 and 63.
TOS	Specify the type of service (TOS) priority level.
<b>Metering</b>	
You can configure the desired bandwidth available to a traffic flow. Traffic that exceeds the maximum bandwidth allocated (in cases where the network is congested) is called out-of-profile traffic.	
Bandwidth	Specify the bandwidth in kilobit per second (Kbps). Enter a number between 1 and 1000000.
Out-of-Profile DSCP	Specify a new DSCP number (between 0 and 63) if you want to replace or remark the DSCP number for out-of-profile traffic.
<b>Action</b>	
Specify the action(s) the switch takes on the associated classified traffic flow.	
<b>Forwarding</b>	
Select <b>No change</b> to forward the packets. Select <b>Discard the packet</b> to drop the packets. Select <b>Do not drop the matching frame previously marked for dropping</b> to retain the frames that were marked to be dropped before.	
<b>Priority</b>	
Select <b>No change</b> to keep the priority setting of the frames. Select <b>Set the packet's 802.1 priority</b> to replace the packet's 802.1 priority field with the value you set in the Priority field. Select <b>Send the packet to priority queue</b> to put the packets in the designated queue. Select <b>Replace the 802.1 priority field with the IP TOS value</b> to replace the packet's 802.1 priority field with the value you set in the TOS field.	

**Table 46** Policy (continued)

LABEL	DESCRIPTION
Diffserv	Select <b>No change</b> to keep the TOS and/or DSCP fields in the packets. Select <b>Set the packet's TOS field</b> to set the TOS field with the value you configure in the <b>TOS</b> field. Select <b>Replace the IP TOS with the 802.1 priority value</b> to replace the TOS field with the value you configure in the <b>Priority</b> field. Select <b>Set the Diffserv Codepoint field in the frame</b> to set the DSCP field with the value you configure in the <b>DSCP</b> field.
Outgoing	Select <b>Send the packet to the mirror port</b> to send the packet to the mirror port. Select <b>Send the packet to the egress port</b> to send the packet to the egress port. Select <b>Send the matching frames (broadcast or DLF, multicast, marked for dropping or to be sent to the CPU) to the egress port</b> to send the broadcast, multicast, DLF, marked-to-drop or CPU frames to the egress port. Select <b>Set the packet's VLAN ID</b> to set the VLAN ID of the packet with the value you configure in the <b>VLAN ID</b> field.
Metering	Select <b>Enable</b> to activate bandwidth limitation on the traffic flow(s) then set the actions to be taken on out-of-profile packets.
Out-of-profile action	Select the action(s) to be performed for out-of-profile traffic. Select <b>Drop the packet</b> to discard the out-of-profile traffic. Select <b>Change the DSCP value</b> to replace the DSCP field with the value specified in the <b>Out of profile DSCP</b> field. Select <b>Set Out-Drop Precedence</b> to mark out-of-profile traffic and drop it when network is congested. Select <b>Do not drop the matching frame previously marked for dropping</b> to queue the frames that are marked to be dropped.
Add	Click <b>Add</b> to inset the entry to the summary table below.
Cancel	Click <b>Cancel</b> to reset the fields back to your previous configuration.
Clear	Click <b>Clear</b> to set the above fields back to the factory defaults.

## 19.3 Viewing and Editing Policy Configuration

To view a summary of the classifier configuration, scroll down to the summary table at the bottom of the **Policy** screen. To change the settings of a rule, click a number in the **Index** field.

**Figure 65** Policy: Summary Table

Index	Active	Name	Classifier(s)	Delete
<a href="#">1</a>	Yes	Test	Example;	<input type="checkbox"/>

The following table describes the labels in this screen.

**Table 47** Policy: Summary Table

<b>LABEL</b>	<b>DESCRIPTION</b>
Index	This field displays the policy index number. Click an index number to edit the policy.
Active	This field displays <b>Yes</b> when policy is activated and <b>No</b> when is it deactivated.
Name	This field displays the descriptive name for this policy. This is for identification purposes only.
Classifier(s)	This field displays the name(s) of the classifier to which this policy applies.
Delete	Click <b>Delete</b> to remove the selected entry from the summary table.
Cancel	Click <b>Cancel</b> to clear the <b>Delete</b> check boxes.

## 19.4 Policy Example

The figure below shows an example **Policy** screen where you configure a policy to limit bandwidth and discard out-of-band traffic on a traffic flow classified using the **Example** classifier (refer to [Section 18.4 on page 145](#)).



Figure 66 Policy Example

Policy																										
Active	<input checked="" type="checkbox"/>																									
Name	Test																									
Classifier(s)	Example																									
Parameters	<table border="0"> <tr> <td>VLAN ID</td> <td>General</td> <td><input type="text" value="1"/></td> <td>Metering</td> <td><input type="text" value="600"/> kbps</td> </tr> <tr> <td>Egress Port</td> <td><input type="text" value="1"/></td> <td>Out-of-Profile</td> <td><input type="text" value="0"/></td> </tr> <tr> <td>Outgoing packet format for Egress port</td> <td><input checked="" type="radio"/> Tag <input type="radio"/> Untag</td> <td>DSCP</td> <td><input type="text" value="0"/></td> </tr> <tr> <td>Priority</td> <td><input type="text" value="0"/></td> <td></td> <td></td> </tr> <tr> <td>DSCP</td> <td><input type="text" value="0"/></td> <td></td> <td></td> </tr> <tr> <td>TOS</td> <td><input type="text" value="0"/></td> <td></td> <td></td> </tr> </table>	VLAN ID	General	<input type="text" value="1"/>	Metering	<input type="text" value="600"/> kbps	Egress Port	<input type="text" value="1"/>	Out-of-Profile	<input type="text" value="0"/>	Outgoing packet format for Egress port	<input checked="" type="radio"/> Tag <input type="radio"/> Untag	DSCP	<input type="text" value="0"/>	Priority	<input type="text" value="0"/>			DSCP	<input type="text" value="0"/>			TOS	<input type="text" value="0"/>		
	VLAN ID	General	<input type="text" value="1"/>	Metering	<input type="text" value="600"/> kbps																					
	Egress Port	<input type="text" value="1"/>	Out-of-Profile	<input type="text" value="0"/>																						
	Outgoing packet format for Egress port	<input checked="" type="radio"/> Tag <input type="radio"/> Untag	DSCP	<input type="text" value="0"/>																						
	Priority	<input type="text" value="0"/>																								
	DSCP	<input type="text" value="0"/>																								
	TOS	<input type="text" value="0"/>																								
Action	Forwarding	<input checked="" type="radio"/> No change																								
		<input type="radio"/> Discard the packet																								
		<input type="radio"/> Do not drop the matching frame previously marked for dropping																								
	Priority	<input checked="" type="radio"/> No change																								
		<input type="radio"/> Set the packet's 802.1 priority																								
		<input type="radio"/> Send the packet to priority queue																								
		<input type="radio"/> Replace the 802.1 priority field with the IP TOS value																								
	Diffserv	<input checked="" type="radio"/> No change																								
		<input type="radio"/> Set the packet's TOS field																								
		<input type="radio"/> Replace the IP TOS field with the 802.1 priority value																								
		<input type="radio"/> Set the Diffserv Codepoint field in the frame																								
	Outgoing	<input type="checkbox"/> Send the packet to the mirror port																								
		<input type="checkbox"/> Send the packet to the egress port																								
	<input type="checkbox"/> Send the matching frames(broadcast or DLF, multicast, marked for dropping or to be sent to the CPU) to the egress port																									
	<input type="checkbox"/> Set the packet's VLAN ID																									
Metering	<input type="checkbox"/> Enable																									
Out-of-profile action	<input checked="" type="checkbox"/> Drop the packet																									
	<input type="checkbox"/> Change the DSCP value																									
	<input type="checkbox"/> Set Out-Drop Precedence																									
	<input type="checkbox"/> Do not drop the matching frame previously marked for dropping																									



# CHAPTER 20

## Queuing Method

This chapter introduces the queuing methods supported.

### 20.1 Queuing Method Overview

Queuing is used to help solve performance degradation when there is network congestion. Use the **Queuing Method** screen to configure queuing algorithms for outgoing traffic. See also **Priority Queue Assignment in Switch Setup** and **802.1p Priority in Port Setup** for related information.

Queuing algorithms allow switches to maintain separate queues for packets from each individual source or flow and prevent a source from monopolizing the bandwidth.

#### 20.1.1 Strictly Priority

Strictly Priority (SP) services queues based on priority only. As traffic comes into the switch, traffic on the highest priority queue, Q7 is transmitted first. When that queue empties, traffic on the next highest-priority queue, Q6 is transmitted until Q6 empties, and then traffic is transmitted on Q5 and so on. If higher priority queues never empty, then traffic on lower priority queues never gets sent. SP does not automatically adapt to changing network requirements.

#### 20.1.2 Weighted Fair Scheduling

Weighted Fair Scheduling is used to guarantee each queue's minimum bandwidth based on its bandwidth weight (portion) (the number you configure in the Weight field - see Figure 18 1) when there is traffic congestion. WFS is activated only when a port has more traffic than it can handle. Queues with larger weights get more guaranteed bandwidth than queues with smaller weights. This queuing mechanism is highly efficient in that it divides any available bandwidth across the different traffic queues. By default, the weight for Q0 is 1, for Q1 is 2, for Q2 is 3, and so on. Guaranteed bandwidth is calculated as follows:

$$\frac{\text{Queue Weight}}{\text{Total Queue Weight}} \times \text{Port Speed}$$

For example, using the default setting, Q0 on Port 1 gets a guaranteed bandwidth of:

$$\frac{1}{1+2+3+4+5+6+7+8} \times 100 \text{ Mbps} = 3 \text{ Mbps}$$

### 20.1.3 Weighted Round Robin Scheduling (WRR)

Round Robin Scheduling services queues on a rotating basis and is activated only when a port has more traffic than it can handle. A queue is given an amount of bandwidth irrespective of the incoming traffic on that port. This queue then moves to the back of the list. The next queue is given an equal amount of bandwidth, and then moves to the end of the list; and so on, depending on the number of queues being used. This works in a looping fashion until a queue is empty.

Weighted Round Robin Scheduling (WRR) uses the same algorithm as round robin scheduling, but services queues based on their priority and queue weight (the number you configure in the queue **Weight** field) rather than a fixed amount of bandwidth. WRR is activated only when a port has more traffic than it can handle. Queues with larger weights get more service than queues with smaller weights. This queuing mechanism is highly efficient in that it divides any available bandwidth across the different traffic queues and returns to queues that have not yet emptied.

## 20.2 Configuring Queuing

Click **Advanced Application, Queuing Method** in the navigation panel.

**Figure 67** Queuing Method

The following table describes the labels in this screen.

**Table 48** Queuing Method

LABEL	DESCRIPTION
Method	Select <b>SPQ</b> (Strictly Priority Queuing), <b>WFQ</b> (Weighted Fair Scheduling) or <b>WRR</b> (Weighted Round Robin). Strictly Priority services queues based on priority only. When the highest priority queue empties, traffic on the next highest-priority queue begins. Q7 has the highest priority and Q0 the lowest. Weighted Fair Scheduling is used to guarantee each queue's minimum bandwidth based on their bandwidth portion (weight) (the number you configure in the <b>Weight</b> field). Queues with larger weights get more guaranteed bandwidth than queues with smaller weights. Weighted Round Robin Scheduling services queues on a rotating basis based on their queue weight (the number you configure in the queue <b>Weight</b> field). Queues with larger weights get more service than queues with smaller weights.
FE Port SPQ Enable	This field is applicable only when you select <b>WFQ</b> or <b>WRR</b> . Select a queue ( <b>Q0</b> to <b>Q7</b> ) to have the switch use <b>Strictly Priority</b> to service the subsequent queue(s) after and including the specified queue for the 10/100 Mbps Ethernet ports. For example, if you select <b>Q5</b> , the switch services traffic on <b>Q5</b> , <b>Q6</b> and <b>Q7</b> using <b>Strictly Priority</b> . Select <b>None</b> to always use <b>WFQ</b> or <b>WRR</b> for the 10/100 Mbps Ethernet ports.
Port	This label shows the port you are configuring.

**Table 48** Queuing Method (continued)

LABEL	DESCRIPTION
*	<p>Settings in this row apply to all ports.</p> <p>Use this row only if you want to make some settings the same for all ports. Use this row first to set the common settings and then make adjustments on a port-by-port basis.</p> <p><b>Note:</b> Changes in this row are copied to all the ports as soon as you make them.</p>
Weight	<p>When you select <b>WFQ</b> or <b>WRR</b> enter the queue weight here. Bandwidth is divided across the different traffic queues according to their weights.</p>
GE Port SPQ Enable	<p>This field is applicable only when you select <b>WFQ</b> or <b>WRR</b>.</p> <p>Select a queue (<b>Q0</b> to <b>Q7</b>) to have the switch use <b>Strictly Priority</b> to service the subsequent queue(s) after and including the specified queue for the gigabit ports. For example, if you select <b>Q5</b>, the switch services traffic on <b>Q5</b>, <b>Q6</b> and <b>Q7</b> using <b>Strictly Priority</b>.</p> <p>Select <b>None</b> to always use <b>WFQ</b> or <b>WRR</b> for the gigabit ports.</p>
Apply	<p>Click <b>Apply</b> to save your changes to the switch's run-time memory. The switch loses these changes if it is turned off or loses power, so use the <b>Save</b> link on the top navigation panel to save your changes to the non-volatile memory when you are done configuring.</p>
Cancel	<p>Click <b>Cancel</b> to reset the fields.</p>

# CHAPTER 21

## VLAN Stacking

This chapter shows you how to configure VLAN stacking on your switch. See the chapter on VLANs for more background information on Virtual LAN

### 21.1 VLAN Stacking Overview

A service provider can use VLAN stacking to allow it to distinguish multiple customers VLANs, even those with the same (customer-assigned) VLAN ID, within its network.

Use VLAN stacking to add an outer VLAN tag to the inner IEEE 802.1Q tagged frames that enter the network. By tagging the tagged frames (“double-tagged” frames), the service provider can manage up to 4,094 VLAN groups with each group containing up to 4,094 customer VLANs. This allows a service provider to provide different service, based on specific VLANs, for many different customers.

A service provider’s customers may require a range of VLANs to handle multiple applications. A service provider’s customers can assign their own inner VLAN tags on ports for these applications. The service provider can assign an outer VLAN tag for each customer. Therefore, there is no VLAN tag overlap among customers, so traffic from different customers is kept separate.

#### 21.1.1 VLAN Stacking Example

In the following example figure, both **A** and **B** are Service Provider’s Network (SPN) customers with VPN tunnels between their head offices and branch offices respectively. Both have an identical VLAN tag for their VLAN group. The service provider can separate these two VLANs within its network by adding tag 37 to distinguish customer **A** and tag 48 to distinguish customer **B** at edge device **1** and then stripping those tags at edge device **2** as the data frames leave the network.

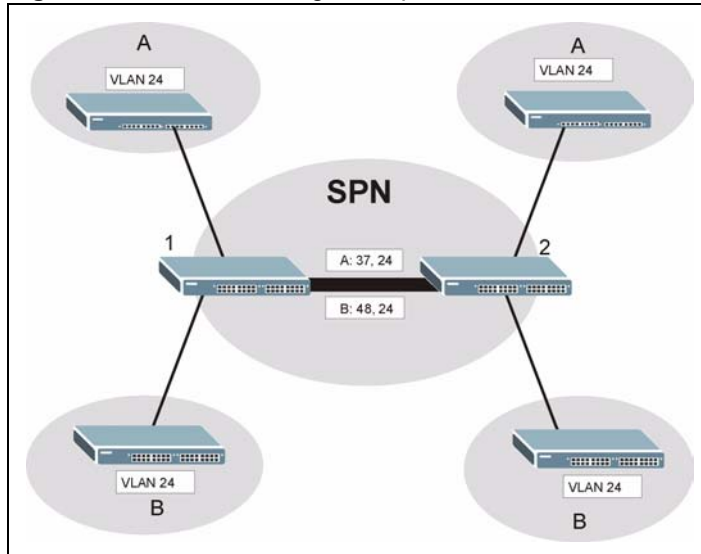
**Figure 68** VLAN Stacking Example

## 21.2 VLAN Stacking Port Roles

Each port can have three VLAN stacking “roles”, **Normal**, **Access Port** and **Tunnel** (the latter is for Gigabit ports only).

- Select **Normal** for “regular” (non-VLAN stacking) IEEE 802.1Q frame switching.
- Select **Access Port** for ingress ports on the service provider's edge devices (**1** and **2** in the VLAN stacking example figure). The incoming frame is treated as “untagged”, so a second VLAN tag (outer VLAN tag) can be added.

**Note:** Static VLAN Tx Tagging MUST be disabled on a port where you choose **Normal** or **Access Port**.

- Select **Tunnel Port** (available for Gigabit ports only) for egress ports at the edge of the service provider's network. All VLANs belonging to a customer can be aggregated into a single service provider's VLAN (using the outer VLAN tag defined by SP VID).

**Note:** Static VLAN Tx Tagging MUST be enabled on a port where you choose **Tunnel Port**.

## 21.3 VLAN Tag Format

A VLAN tag (service provider VLAN stacking or customer IEEE 802.1Q) consists of the following three fields.

**Table 49** VLAN Tag Format

Type	Priority	VID
------	----------	-----



**Type** is a standard Ethernet type code identifying the frame and indicates that whether the frame carries IEEE 802.1Q tag information. **SP TPID** (Service Provider Tag Protocol Identifier) is the service provider VLAN stacking tag type. Many vendors use 0x8100 or 0x9100.

**TPID** (Tag Protocol Identifier) is the customer IEEE 802.1Q tag.

- If the VLAN stacking port role is **Access Port**, then the switch adds the **SP TPID** tag to all incoming frames on the service provider's edge devices (1 and 2 in the VLAN stacking example figure).
- If the VLAN stacking port role is **Tunnel Port**, then the switch only adds the **SP TPID** tag to all incoming frames on the service provider's edge devices (1 and 2 in the VLAN stacking example figure) that have an **SP TPID** different to the one configured on the switch. (If an incoming frame's **SP TPID** is the same as the one configured on the switch, then the switch will not add the tag.)

**Priority** refers to the IEEE 802.1p standard that allows the service provider to prioritize traffic based on the class of service (CoS) the customer has paid for.

- On the switch, configure priority level of inner IEEE 802.1Q tag in the **Port Setup** screen.
- "0" is the lowest priority level and "7" is the highest.

**VID** is the VLAN ID. **SP VID** is the VID for the second (service provider's) VLAN tag.

### 21.3.1 Frame Format

The frame format for an untagged Ethernet frame, a single-tagged 802.1Q frame (customer) and a "double-tagged" 802.1Q frame (service provider) is shown next.

Configure the fields as circled in the switch **VLAN Stacking** screen.

**Table 50** Single and Double Tagged 802.11Q Frame Format

						DA	SA	Len/Etype	Data	FCS	Untagged Ethernet frame
			DA	SA	<b>TPID</b>	<b>Priority</b>	<b>VID</b>	Len/Etype	Data	FCS	IEEE 802.1Q customer tagged frame
DA	SA	<b>SPTPID</b>	<b>Priority</b>	<b>VID</b>	<b>TPID</b>	<b>Priority</b>	<b>VID</b>	Len/Etype	Data	FCS	Double-tagged frame

**Table 51** 802.1Q Frame

DA	Destination Address	Priority	802.1p Priority
SA	Source Address	Len/Etype	Length and type of Ethernet frame
(SP)TPID	(Service Provider) Tag Protocol Identifier	Data	Frame data
VID	VLAN ID	FCS	Frame Check Sequence

## 21.4 Configuring VLAN Stacking

Click **Advanced Applications** and then **VLAN Stacking** to display the screen as shown.

**Figure 69** VLAN Stacking

Port	Role	SPVID	Priority
*	Normal		0
1	Access Port	1	0
2	Access Port	1	0
3	Access Port	1	0
~ ~ ~ ~ ~			
45	Access Port	1	0
46	Access Port	1	0
47	Access Port	1	0
48	Access Port	1	0
49	Access Port	1	0
50	Access Port	1	0
51	Access Port	1	0
52	Access Port	1	0

The following table describes the labels in this screen.

**Table 52** VLAN Stacking

LABEL	DESCRIPTION
Active	Select this checkbox to enable VLAN stacking on the switch.
SP TPID	<b>SP TPID</b> is a standard Ethernet type code identifying the frame and indicates whether the frame carries IEEE 802.1Q tag information. Choose <b>0x8100</b> or <b>0x9100</b> from the drop-down list box or select <b>Others</b> and then enter a four-digit hexadecimal number from 0x0000 to 0xFFFF. 0x denotes a hexadecimal number. It does not have to be typed in the <b>Others</b> text field.
Port	The port number identifies the port you are configuring.

**Table 52** VLAN Stacking (continued)

LABEL	DESCRIPTION
*	<p>Settings in this row apply to all ports.</p> <p>Use this row only if you want to make some settings the same for all ports. Use this row first to set the common settings and then make adjustments on a port-by-port basis.</p> <p><b>Note:</b> Changes in this row are copied to all the ports as soon as you make them.</p>
Role	<p>Select <b>Normal</b> to have the switch ignore frames received (or transmitted) on this port with VLAN stacking tags. Anything you configure in <b>SPVID</b> and <b>Priority</b> are ignored.</p> <p>Select <b>Access Port</b> to have the switch add the <b>SP TPID</b> tag to all incoming frames received on this port. Select <b>Access Port</b> for ingress ports at the edge of the service provider's network.</p> <p>Select <b>Tunnel Port</b> (available for Gigabit ports only) for egress ports at the edge of the service provider's network.</p> <p>In order to support VLAN stacking on a port, the port must be able to allow frames of 1526 Bytes (1522 Bytes + 4 Bytes for the second tag) to pass through it.</p>
SPVID	<p><b>SPVID</b> is the service provider's VLAN ID (the outer VLAN tag). Enter the service provider ID (from 1 to 4094) for frames received on this port. See <a href="#">Chapter 8 on page 87</a> for more background information on VLAN ID.</p>
Priority	<p>On the switch, configure priority level of inner IEEE 802.1Q tag in the <b>Port Setup</b> screen. "0" is the lowest priority level and "7" is the highest.</p>
Apply	<p>Click <b>Apply</b> to save your changes back to the switch.</p>
Cancel	<p>Click <b>Cancel</b> to begin configuring this screen afresh.</p>



# CHAPTER 22

## Multicast

This chapter shows you how to configure various multicast features.

### 22.1 Multicast Overview

Traditionally, IP packets are transmitted in one of either two ways - Unicast (1 sender to 1 recipient) or Broadcast (1 sender to everybody on the network). Multicast delivers IP packets to just a group of hosts on the network.

IGMP (Internet Group Multicast Protocol) is a network-layer protocol used to establish membership in a multicast group - it is not used to carry user data. Refer to RFC 1112 and RFC 2236 for information on IGMP versions 1 and 2 respectively.

#### 22.1.1 IP Multicast Addresses

In IPv4, a multicast address allows a device to send packets to a specific group of hosts (multicast group) in a different subnetwork. A multicast IP address represents a traffic receiving group, not individual receiving devices. IP addresses in the Class D range (224.0.0.0 to 239.255.255.255) are used for IP multicasting. Certain IP multicast numbers are reserved by IANA for special purposes (see the IANA web site for more information).

#### 22.1.2 IGMP Filtering

With the IGMP filtering feature, you can control which IGMP groups a subscriber on a port can join. This allows you to control the distribution of multicast services (such as content information distribution) based on service plans and types of subscription.

You can set the switch to filter the multicast group join reports on a per-port basis by configuring an IGMP filtering profile and associating the profile to a port.

#### 22.1.3 IGMP Snooping

A switch can passively snoop on IGMP Query, Report and Leave (IGMP version 2) packets transferred between IP multicast routers/switches and IP multicast hosts to learn the IP multicast group membership. It checks IGMP packets passing through it, picks out the group registration information, and configures multicasting accordingly. IGMP snooping allows the switch to learn multicast groups without you having to manually configure them.

The switch forwards multicast traffic destined for multicast groups (that it has learned from IGMP snooping or that you have manually configured) to ports that are members of that group. IGMP snooping generates no additional network traffic, allowing you to significantly reduce multicast traffic passing through your switch.

## 22.2 Multicast Status

Click **Advanced Applications** and **Multicast** to display the screen as shown. This screen shows the multicast group information. See [Section 22.1 on page 165](#) for more information on multicasting.

**Figure 70** Multicast Status.

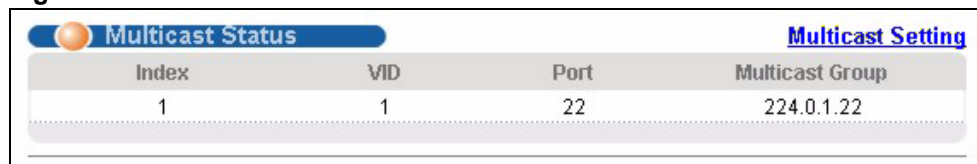

Multicast Status			Multicast Setting
Index	VID	Port	Multicast Group
1	1	22	224.0.1.22

The following table describes the labels in this screen.

**Table 53** Multicast Status

LABEL	DESCRIPTION
Index	This is the index number of the entry.
VID	This field displays the multicast VLAN ID.
Port	This field displays the port number that belongs to the multicast group.
Multicast Group	This field displays IP multicast group addresses.

## 22.3 Multicast Setting

Click **Advanced Applications**, **Multicast** and the **Multicast Setting** link to display the screen as shown. See [Section 22.1 on page 165](#) for more information on multicasting.

Figure 71 Multicast Setting

Multicast Setting		Multicast Status	IGMP Filtering Profile	MVR
IGMP Snooping		Active <input type="checkbox"/>	Host Timeout <input type="text" value="260"/>	Leave Timeout <input type="text" value="2"/>
			802.1p Priority <input type="text" value="No-Change"/>	
IGMP Filtering		Active <input type="checkbox"/>		
Unknown Multicast Frame		<input checked="" type="radio"/> Flooding	<input type="radio"/> Drop	
Reserved Multicast Group		<input checked="" type="radio"/> Flooding	<input type="radio"/> Drop	

Port	Immed. Leave	Group Limited	Max Group Num.	IGMP Filtering Profile	IGMP Querier Mode
*	<input type="checkbox"/>	<input type="checkbox"/>	<input type="text"/>	Default	Auto
1	<input type="checkbox"/>	<input type="checkbox"/>	0	Default	Auto
2	<input type="checkbox"/>	<input type="checkbox"/>	0	Default	Auto
3	<input type="checkbox"/>	<input type="checkbox"/>	0	Default	Auto
45	<input type="checkbox"/>	<input type="checkbox"/>	0	Default	Auto
46	<input type="checkbox"/>	<input type="checkbox"/>	0	Default	Auto
47	<input type="checkbox"/>	<input type="checkbox"/>	0	Default	Auto
48	<input type="checkbox"/>	<input type="checkbox"/>	0	Default	Auto
49	<input type="checkbox"/>	<input type="checkbox"/>	0	Default	Auto
50	<input type="checkbox"/>	<input type="checkbox"/>	0	Default	Auto
51	<input type="checkbox"/>	<input type="checkbox"/>	0	Default	Auto
52	<input type="checkbox"/>	<input type="checkbox"/>	0	Default	Auto

The following table describes the labels in this screen.

Table 54 Multicast Setting

LABEL	DESCRIPTION
IGMP Snooping	Use these settings to configure IGMP Snooping.
Active	Select <b>Active</b> to enable IGMP Snooping to forward group multicast traffic only to ports that are members of that group.
Host Timeout	Specify the time (from 1 to 16,711,450) in seconds that elapses before the switch removes an IGMP group membership entry if it does not receive report messages from the port.
Leave Timeout	Enter an IGMP leave timeout value (from 1 to 16,711,450) in seconds. This defines how many seconds the switch waits for an IGMP report before removing an IGMP snooping membership entry when an IGMP leave message is received from a host.
802.1p Priority	Select a priority level (0-7) to which the switch changes the priority in outgoing IGMP control packets. Otherwise, select <b>No-Change</b> to not replace the priority.
IGMP Filtering	Select <b>Active</b> to enable IGMP filtering to control which IGMP groups a subscriber on a port can join.

**Table 54** Multicast Setting (continued)

LABEL	DESCRIPTION
Unknown Multicast Frame	Specify the action to perform when the switch receives an unknown multicast frame. Select <b>Drop</b> to discard the frame(s). Select <b>Flooding</b> to send the frame(s) to all ports.
Reserved Multicast Group	Multicast addresses (224.0.0.0 to 224.0.0.255) are reserved for the local scope. For examples, 224.0.0.1 is for all hosts in this subnet, 224.0.0.2 is for all multicast routers in this subnet, etc. A router will not forward a packet with the destination IP address within this range. See the IANA web site for more information. Specify the action to perform when the switch receives a frame with a reserved multicast address. Select <b>Drop</b> to discard the frame(s). Select <b>Flooding</b> to send the frame(s) to all ports.
Port	This field displays the port number.
*	Settings in this row apply to all ports. Use this row only if you want to make some settings the same for all ports. Use this row first to set the common settings and then make adjustments on a port-by-port basis.  <b>Note:</b> Changes in this row are copied to all the ports as soon as you make them.
Immed. Leave	Select this option to set the switch to remove this port from the multicast tree when an IGMP version 2 leave message is received on this port. Select this option if there is only one host connected to this port.
Group Limited	Select this option to limit the number of multicast groups this port is allowed to join.
Max Group Num.	Enter the number of multicast groups this port is allowed to join. Once a port is registered in the specified number of multicast groups, any new IGMP join report frame(s) is dropped on this port.
IGMP Filtering Profile	Select the name of the IGMP filtering profile to use for this port. Otherwise, select <b>Default</b> to prohibit the port from joining any multicast group.
IGMP Querier Mode	The switch treats an IGMP query port as being connected to an IGMP multicast router (or server). The switch forwards IGMP join or leave packets to an IGMP query port. Select <b>Auto</b> to have the switch use the port as an IGMP query port if the port receives IGMP query packets. Select <b>Fixed</b> to have the switch always use the port as an IGMP query port. Select this when you connect an IGMP multicast server to the port. Select <b>Edge</b> to stop the switch from using the port as an IGMP query port. The switch will not keep any record of an IGMP router being connected to this port. The switch does not forward IGMP join or leave packets to this port.
Apply	Click <b>Apply</b> to save your changes to the switch's run-time memory. The switch loses these changes if it is turned off or loses power, so use the <b>Save</b> link on the top navigation panel to save your changes to the non-volatile memory when you are done configuring.
Cancel	Click <b>Cancel</b> to reset the fields.



## 22.4 IGMP Filtering Profile

IGMP filter profiles allow you to control access to IGMP multicast groups. This allows you to have a service available to a specific IGMP multicast group. You can configure an IGMP filter profile for an IGMP multicast group that has access to a service (like a SIP server for example). Within a profile, configure an IGMP filter to specify the multicast IP address ranges. Then assign the IGMP filter profile to the ports (in the **Multicast Setting** screen) that are allowed to use the service.

Click **Advanced Applications** and **Multicast** in the navigation panel. Click the **Multicast Setting** link and then the **IGMP Filtering Profile** link to display the screen as shown.

**Figure 72** Multicast: IGMP Filtering Profile

The following table describes the labels in this screen.

**Table 55** Multicast: IGMP Filtering Profile

LABEL	DESCRIPTION
Profile Name	Enter a descriptive name for the profile for identification purposes. To configure additional rule(s) for a profile that you have already added, enter the profile name and specify a different IP multicast address range.
Start Address	Type the starting multicast IP address for a range of multicast IP addresses that you want to belong to the IGMP filter profile.
End Address	Type the ending multicast IP address for a range of IP addresses that you want to belong to the IGMP filter profile. If you want to add a single multicast IP address, enter it in both the <b>Start Address</b> and <b>End Address</b> fields.
Add	Click <b>Add</b> to save the settings to the switch.
Clear	Click <b>Clear</b> to clear the fields to the factory defaults.
Profile Name	This field displays the descriptive name of the profile.
Start Address	This field displays the start of the multicast address range.

**Table 55** Multicast: IGMP Filtering Profile (continued)

LABEL	DESCRIPTION
End Address	This field displays the end of the multicast address range.
Delete	To delete the profile(s) and all the accompanying rules, select the profile(s) that you want to remove in the <b>Delete Profile</b> column, then click the <b>Delete</b> button. To delete a rule(s) from a profile, select the rule(s) that you want to remove in the <b>Delete Rule</b> column, then click the <b>Delete</b> button.
Cancel	Click <b>Cancel</b> to clear the <b>Delete Profile/Delete Rule</b> check boxes.

## 22.5 MVR Overview

Multicast VLAN Registration (MVR) is designed for applications (such as Media-on-Demand (MoD)) that use multicast traffic across an Ethernet ring-based service provider network.

MVR allows one single multicast VLAN to be shared among different subscriber VLANs on the network. While isolated in different subscriber VLANs, connected devices can subscribe to and unsubscribe from the multicast stream in the multicast VLAN. This improves bandwidth utilization with reduced multicast traffic in the subscriber VLANs and simplifies multicast group management.

You must enable IGMP snooping to use MVR. However, MVR only responds to IGMP join and leave control messages from multicast groups that are configured under MVR. Join and leave reports from other multicast groups are managed by IGMP snooping.

The following figure shows a network example. The subscriber VLAN (**1, 2 and 3**) information is hidden from the streaming media server, **S**. In addition, the multicast VLAN information is only visible to the switch and **S**.

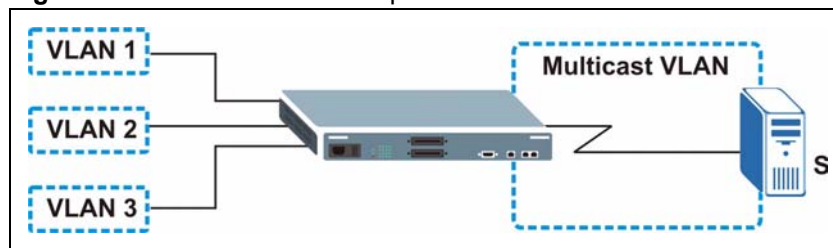
**Figure 73** MVR Network Example

### 22.5.1 Types of MVR Ports

In MVR, a source port is a port on the switch that can send and receive multicast traffic in a multicast VLAN while a receiver port can only receive multicast data. Once configured, the switch maintains a forwarding table that matches the multicast stream to the associated multicast group.

## 22.5.2 MVR Modes

You can set your switch to operate in either dynamic or compatible mode.

In dynamic mode, the switch sends IGMP leave and join reports to the other multicast devices (such as multicast routers or servers) in the multicast VLAN. This allows the multicast devices to update the multicast forwarding table to forward or not forward multicast traffic to the receiver ports.

In compatible mode, the switch does not send any IGMP reports. In this case, you must manually configure the forwarding settings on the multicast devices in the multicast VLAN.

## 22.5.3 How MVR Works

The following figure shows a multicast television example where a subscriber device (such as a computer) in VLAN 1 receives multicast traffic from the streaming media server, **S**, via the switch. Multiple subscriber devices can connect through a port configured as the receiver on the switch.

When the subscriber selects a television channel, computer **A** sends an IGMP report to the switch to join the appropriate multicast group. If the IGMP report matches one of the configured MVR multicast group addresses on the switch, an entry is created in the forwarding table on the switch. This maps the subscriber VLAN to the list of forwarding destinations for the specified multicast traffic.

When the subscriber changes the channel or turns off the computer, an IGMP leave message is sent to the switch to leave the multicast group. The switch sends a query to VLAN 1 on the receiver port (in this case, a DSL port on the switch). If there is another subscriber device connected to this port in the same subscriber VLAN, the receiving port will still be on the list of forwarding destination for the multicast traffic. Otherwise, the switch removes the receiver port from the forwarding table.

**Figure 74** MVR Multicast Television Example

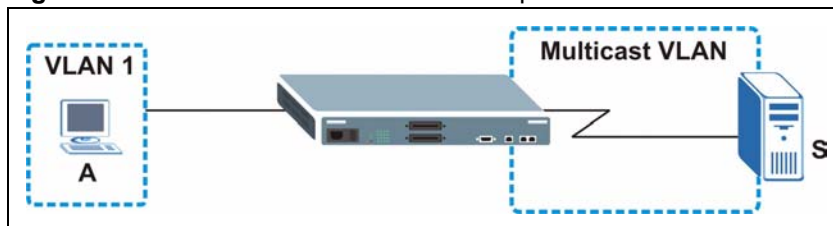

## 22.6 General MVR Configuration

Use the **MVR** screen to create multicast VLANs and select the receiver port(s) and a source port for each multicast VLAN. Click **Advanced Applications** and **Multicast** in the navigation panel. Click the **Multicast Setting** link and then the **MVR** link to display the screen as shown next.

**Note:** You can create up to three multicast VLANs and up to 256 multicast rules on the switch.

Your switch automatically creates a static VLAN (with the same VID) when you create a multicast VLAN in this screen.

**Figure 75** MVR

The following table describes the related labels in this screen.

**Table 56** MVR

LABEL	DESCRIPTION
Active	Select this check box to enable MVR to allow one single multicast VLAN to be shared among different subscriber VLANs on the network.
Name	Enter a descriptive name (up to 32 printable ASCII characters) for identification purposes.
Multicast VLAN ID	Enter the VLAN ID (1 to 4094) of the multicast VLAN.
802.1p Priority	Select a priority level (0-7) with which the switch replaces the priority in outgoing IGMP control packets (belonging to this multicast VLAN).

**Table 56** MVR (continued)

LABEL	DESCRIPTION
Mode	Specify the MVR mode on the switch. Choices are <b>Dynamic</b> and <b>Compatible</b> . Select <b>Dynamic</b> to send IGMP reports to all MVR source ports in the multicast VLAN. Select <b>Compatible</b> to set the switch not to send IGMP reports.
Port	This field displays the port number on the switch.
*	Settings in this row apply to all ports. Use this row only if you want to make some settings the same for all ports. Use this row first to set the common settings and then make adjustments on a port-by-port basis.  <b>Note:</b> Changes in this row are copied to all the ports as soon as you make them.
Source Port	Select this option to set this port as the MVR source port that sends and receives multicast traffic. All source ports must belong to a single multicast VLAN.
Receiver Port	Select this option to set this port as a receiver port that only receives multicast traffic.
None	Select this option to set the port not to participate in MVR. No MVR multicast traffic is sent or received on this port.
Tagging	Select this checkbox if you want the port to tag the VLAN ID in all outgoing frames transmitted.
Add	Click <b>Add</b> to save your changes to the switch's run-time memory. The switch loses these changes if it is turned off or loses power, so use the <b>Save</b> link on the top navigation panel to save your changes to the non-volatile memory when you are done configuring.
Cancel	Click <b>Cancel</b> to reset the fields.
VLAN	This field displays the multicast VLAN ID.
Active	This field displays whether the multicast group is enabled or not.
Name	This field displays the descriptive name for this setting.
Mode	This field displays the MVR mode.
Source Port	This field displays the source port number(s).
Receiver Port	This field displays the receiver port number(s).
802.1p	This field displays the priority level.
Delete	To delete a multicast VLAN(s), select the rule(s) that you want to remove in the <b>Delete</b> column, then click the <b>Delete</b> button.
Cancel	Click <b>Cancel</b> to clear the <b>Delete</b> check boxes.

## 22.7 MVR Group Configuration

All source ports and receiver ports belonging to a multicast group can receive multicast data sent to this multicast group.

Configure MVR IP multicast group address(es) in the **Group Configuration** screen. Click **Group Configuration** in the **MVR** screen.

**Note:** A port can belong to more than one multicast VLAN. However, IP multicast group addresses in different multicast VLANs cannot overlap.

**Figure 76** MVR: Group Configuration

The following table describes the labels in this screen.

**Table 57** MVR: Group Configuration

LABEL	DESCRIPTION
Multicast VLAN ID	Select a multicast VLAN ID (that you configured in the <b>MVR</b> screen) from the drop-down list box.
Name	Enter a descriptive name for identification purposes.
Start Address	Enter the starting IP multicast address of the multicast group in dotted decimal notation. Refer to <a href="#">Section 22.1.1 on page 165</a> for more information on IP multicast addresses.
End Address	Enter the ending IP multicast address of the multicast group in dotted decimal notation. Enter the same IP address as the <b>Start Address</b> field if you want to configure only one IP address for a multicast group. Refer to <a href="#">Section 22.1.1 on page 165</a> for more information on IP multicast addresses.
Add	Click <b>Add</b> to save your changes to the switch's run-time memory. The switch loses these changes if it is turned off or loses power, so use the <b>Save</b> link on the top navigation panel to save your changes to the non-volatile memory when you are done configuring.
Cancel	Click <b>Cancel</b> to reset the fields.
MVLAN	This field displays the multicast VLAN ID.
Name	This field displays the descriptive name for this setting.
Start Address	This field displays the starting IP address of the multicast group.
End Address	This field displays the ending IP address of the multicast group.
Delete	Select <b>Delete Group</b> and click <b>Delete</b> to remove the selected entry(ies) from the table.
Cancel	Select <b>Cancel</b> to clear the checkbox(es) in the table.

## 22.7.1 MVR Configuration Example

The following figure shows a network example where ports 1, 2 and 3 on the switch belong to VLAN 1. In addition, port 7 belongs to the multicast group with VID 200 to receive multicast traffic (the **News** and **Movie** channels) from the remote streaming media server, **S**. Computers **A**, **B** and **C** in VLAN are able to receive the traffic.

**Figure 77** MVR Configuration Example

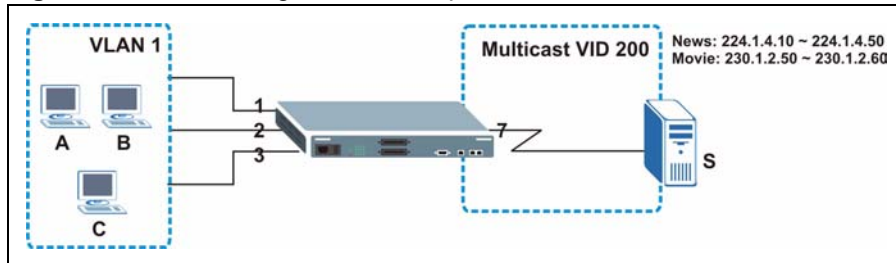

To configure the MVR settings on the switch, create a multicast group in the **MVR** screen and set the receiver and source ports.

**Figure 78** MVR Configuration Example

**MVR** Multicast Setting **Group Configuration**

Active

Name

Multicast VLAN ID

802.1p Priority

Mode  Dynamic  Compatible

Port	Source Port	Receiver Port	None	Tagging
*		None		<input type="checkbox"/>
1	<input type="radio"/>	<input checked="" type="radio"/>	<input type="radio"/>	<input type="checkbox"/>
2	<input type="radio"/>	<input checked="" type="radio"/>	<input type="radio"/>	<input type="checkbox"/>
3	<input type="radio"/>	<input checked="" type="radio"/>	<input type="radio"/>	<input type="checkbox"/>
4	<input type="radio"/>	<input type="radio"/>	<input checked="" type="radio"/>	<input type="checkbox"/>
5	<input type="radio"/>	<input type="radio"/>	<input checked="" type="radio"/>	<input type="checkbox"/>
6	<input type="radio"/>	<input type="radio"/>	<input checked="" type="radio"/>	<input type="checkbox"/>
7	<input type="radio"/>	<input checked="" type="radio"/>	<input type="radio"/>	<input type="checkbox"/>
8	<input type="radio"/>	<input type="radio"/>	<input checked="" type="radio"/>	<input type="checkbox"/>
9	<input type="radio"/>	<input type="radio"/>	<input checked="" type="radio"/>	<input type="checkbox"/>
10	<input type="radio"/>	<input type="radio"/>	<input checked="" type="radio"/>	<input type="checkbox"/>
11	<input type="radio"/>	<input type="radio"/>	<input checked="" type="radio"/>	<input type="checkbox"/>
12	<input type="radio"/>	<input type="radio"/>	<input checked="" type="radio"/>	<input type="checkbox"/>
13	<input type="radio"/>	<input type="radio"/>	<input checked="" type="radio"/>	<input type="checkbox"/>
14	<input type="radio"/>	<input type="radio"/>	<input checked="" type="radio"/>	<input type="checkbox"/>
15	<input type="radio"/>	<input type="radio"/>	<input checked="" type="radio"/>	<input type="checkbox"/>
16	<input type="radio"/>	<input type="radio"/>	<input checked="" type="radio"/>	<input type="checkbox"/>
17	<input type="radio"/>	<input type="radio"/>	<input checked="" type="radio"/>	<input type="checkbox"/>
18	<input type="radio"/>	<input type="radio"/>	<input checked="" type="radio"/>	<input type="checkbox"/>
19	<input type="radio"/>	<input type="radio"/>	<input checked="" type="radio"/>	<input type="checkbox"/>
46	<input type="radio"/>	<input type="radio"/>	<input checked="" type="radio"/>	<input type="checkbox"/>
47	<input type="radio"/>	<input type="radio"/>	<input checked="" type="radio"/>	<input type="checkbox"/>
48	<input type="radio"/>	<input type="radio"/>	<input checked="" type="radio"/>	<input type="checkbox"/>
49	<input type="radio"/>	<input type="radio"/>	<input checked="" type="radio"/>	<input type="checkbox"/>
50	<input type="radio"/>	<input type="radio"/>	<input checked="" type="radio"/>	<input type="checkbox"/>
51	<input type="radio"/>	<input type="radio"/>	<input checked="" type="radio"/>	<input type="checkbox"/>
52	<input type="radio"/>	<input type="radio"/>	<input checked="" type="radio"/>	<input type="checkbox"/>

Add Cancel

VLAN	Active	Name	Mode	Source Port	Receiver Port	802.1p	Delete
------	--------	------	------	-------------	---------------	--------	--------

Delete Cancel

To set the switch to forward the multicast group traffic to the subscribers, configure multicast group settings in the **Group Configuration** screen. The following figure shows an example where two multicast groups (**News** and **Movie**) are configured for the multicast VLAN 200.



**Figure 79** MVR Group Configuration Example

The screenshot shows the 'Group Configuration' interface for MVR. At the top, there is a 'Multicast VLAN ID' dropdown menu set to '200'. Below this is a table for adding new groups:

Name	Start Address	End Address
News	224.1.4.10	224.1.4.50

Below the table are 'Add' and 'Cancel' buttons. At the bottom, there is a summary table for the selected Multicast VLAN (200):

MVLAN	Name	Start Address	End Address	Delete All	Delete Group
200	Movie	230.1.2.50	230.1.2.60	<input type="checkbox"/>	<input type="checkbox"/>

At the bottom of the summary table are 'Delete' and 'Cancel' buttons. A red oval highlights the 'News' entry in the top table.

**Figure 80** MVR Group Configuration Example

The screenshot shows the 'Group Configuration' interface for MVR. At the top, there is a 'Multicast VLAN ID' dropdown menu set to '200'. Below this is a table for adding new groups:

Name	Start Address	End Address
	0.0.0.0	0.0.0.0

Below the table are 'Add' and 'Cancel' buttons. At the bottom, there is a summary table for the selected Multicast VLAN (200):

MVLAN	Name	Start Address	End Address	Delete All	Delete Group
200	Movie	230.1.2.50	230.1.2.60	<input type="checkbox"/>	<input type="checkbox"/>
	News	224.1.4.10	224.1.4.50	<input type="checkbox"/>	<input type="checkbox"/>

At the bottom of the summary table are 'Delete' and 'Cancel' buttons. A red oval highlights the 'Movie' and 'News' entries in the bottom table.



# CHAPTER 23

## DHCP Relay

This chapter shows you how to set up DHCP relay.

### 23.1 DHCP Relay Overview

DHCP (Dynamic Host Configuration Protocol, RFC 2131 and RFC 2132) allows individual clients to obtain TCP/IP configuration at start-up from a DHCP server. You can configure the switch to relay client DHCP requests to a DHCP server and the server's responses back to the clients.

#### 23.1.1 DHCP Relay Agent Information

The switch can add information to client DHCP requests that it relays to a DHCP server. This helps provide authentication about the source of the requests. You can also specify additional information for the switch to add to the client DHCP requests that it relays to the DHCP server. Please refer to RFC 3046 for more details.

The DHCP relay agent information feature adds an Agent Information field to the option 82 field of the DHCP headers of client TCP/IP configuration request frames that the switch relays to a DHCP server. The following lists the DHCP relay agent option 82 information that the switch sends to the DHCP server:

- Slot ID (1 byte)
- Port ID (1 byte)
- VLAN ID (2 bytes)
- System name (up to 32 bytes, this is optional).

### 23.2 DHCP Relay Configuration

To configure DHCP relay information and specify the DHCP server(s), click **Advanced Application** and **DHCP Relay** to display the screen as shown next.

**Figure 81** DHCP Relay

The following table describes the labels in this screen.

**Table 58** DHCP Relay

LABEL	DESCRIPTION
Active	Select this check box to enable DHCP relay.
Remote DHCP Server 1 .. 3	Enter the IP address of a DHCP server in dotted decimal notation.
Relay Agent Information	Select the <b>Option 82</b> check box to have the switch add information (slot number, port number and VLAN ID) to client DHCP requests that it relays to a DHCP server.
Information	This read-only field displays the system name you configure in the General Setup screen. Select the check box for the switch to add the system name to the DHCP client DHCP requests that it relays to a DHCP server.
Apply	Click <b>Apply</b> to save your changes to the switch's run-time memory. The switch loses these changes if it is turned off or loses power, so use the <b>Save</b> link on the top navigation panel to save your changes to the non-volatile memory when you are done configuring.
Cancel	Click <b>Cancel</b> to reset the fields.

# CHAPTER 24

## Static Route

This chapter shows you how to configure static routes.

### 24.1 Configuring Static Route

Static routes tell the switch how to forward IP traffic when you configure the TCP/IP parameters manually.

Click **IP Application**, **Static Routing** in the navigation panel to display the screen as shown.

**Figure 82** Static Routing

The following table describes the related labels you use to create a static route.

**Table 59** Static Routing

LABEL	DESCRIPTION
Active	This field allows you to activate/deactivate this static route.
Name	Enter a descriptive name (up to 32 printable ASCII characters) for identification purposes.

**Table 59** Static Routing (continued)

LABEL	DESCRIPTION
Destination IP Address	This parameter specifies the IP network address of the final destination. Routing is always based on network number. If you need to specify a route to a single host, use a subnet mask of 255.255.255.255 in the subnet mask field to force the network number to be identical to the host ID.
IP Subnet Mask	Enter the subnet mask for this destination.
Gateway IP Address	Enter the IP address of the gateway. The gateway is an immediate neighbor of your switch that will forward the packet to the destination. The gateway must be a router on the same segment as your switch.
Metric	The metric represents the “cost” of transmission for routing purposes. IP routing uses hop count as the measurement of cost, with a minimum of 1 for directly connected networks. Enter a number that approximates the cost for this link. The number need not be precise, but it must be between 1 and 15. In practice, 2 or 3 is usually a good number.
Add	Click <b>Add</b> to save your static route to the switch’s run-time memory. The switch discards this route if it is turned off or loses power, so use the <b>Save</b> link on the top navigation panel to save your changes to the non-volatile memory when you are done configuring.
Cancel	Click <b>Cancel</b> to reset the fields.
Clear	Click <b>Clear</b> to set the above fields back to the factory defaults.
Index	This field displays the index number of the route. Click a number to edit the static route entry.
Active	This field displays <b>Yes</b> when the static route is activated and <b>NO</b> when it is deactivated.
Name	This field displays the descriptive name for this route. This is for identification purpose only.
Destination Address	This field displays the IP network address of the final destination.
Subnet Mask	This field displays the subnet mask for this destination.
Gateway Address	This field displays the IP address of the gateway. The gateway is an immediate neighbor of your switch that will forward the packet to the destination.
Metric	This field displays the cost of transmission for routing purposes.
Delete	Click <b>Delete</b> to remove the selected entry from the summary table.
Cancel	Click <b>Cancel</b> to clear the <b>Delete</b> check boxes.

# CHAPTER 25

## DiffServ Code Point

This chapter shows you how to set up Diffserv Code Point (DSCP) on each port and how to convert DSCP values to IEEE 802.1p values.

### 25.1 DiffServ Overview

DiffServ Code Point (DSCP) is a field used for packet classification on DiffServ networks. The higher the value, the higher the priority. Lower-priority packets may be dropped if the total traffic exceeds the capacity of the network.

### 25.2 Enable DiffServ

Click **IP Application**, **DiffServ** in the navigation panel to display the screen as shown.

**Figure 83** DiffServ

The screenshot shows the DiffServ configuration interface. At the top, there is a header with an orange circle icon, the text 'Diffserv', and a link 'DSCP Setting'. Below this is a section labeled 'Active' with a checkbox that is currently unchecked. A table below lists various ports and their corresponding 'Active' status. The table has two columns: 'Port' and 'Active'. The rows are as follows:

Port	Active
*	<input type="checkbox"/>
1	<input type="checkbox"/>
2	<input type="checkbox"/>
3	<input type="checkbox"/>
45	<input type="checkbox"/>
46	<input type="checkbox"/>
47	<input type="checkbox"/>
48	<input type="checkbox"/>
49	<input type="checkbox"/>
50	<input type="checkbox"/>
51	<input type="checkbox"/>
52	<input type="checkbox"/>

At the bottom of the form, there are two buttons: 'Apply' and 'Cancel'.

The following table describes the related labels you use to create a static route.

**Table 60** Static Routing

LABEL	DESCRIPTION
DSCP Setting	Click DSCP Map to open the screen where you can set up the mapping between source DSCP priority and IEEE 802.1p priority.
Active	This field allows you to activate/deactivate DiffServ on the switch.
Port	This read-only index number indicates which port you are activating.
*	Settings in this row apply to all ports. Use this row only if you want to make some settings the same for all ports. Use this row first to set the common settings and then make adjustments on a port-by-port basis.  <b>Note:</b> Changes in this row are copied to all the ports as soon as you make them.
Active	This allows you to activate DiffServ on a per port basis.
Apply	Click <b>Apply</b> to save your changes to the switch's run-time memory. The switch loses these changes if it is turned off or loses power, so use the <b>Save</b> link on the top navigation panel to save your changes to the non-volatile memory when you are done configuring.
Cancel	Click <b>Cancel</b> to reset the fields.

## 25.3 Configure DSCP Setting

Use this screen to convert DSCP priority to IEEE 802.1p priority. Click **IP Application**, **DiffServ**, **DSCP** in the navigation panel to display the screen as shown.

**Figure 84** DiffServ

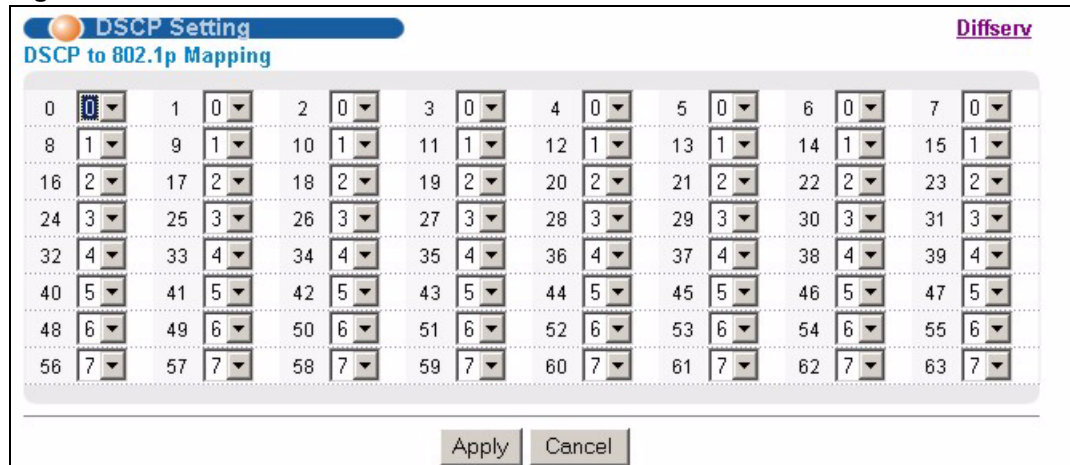



The following table describes the related labels you use to create a static route.

**Table 61** Static Routing

LABEL	DESCRIPTION
Diffserv	Click this to return to the main DiffServ screen.
DSCP to 802.1p Mapping	In this section you map each DSCP value with an 802.1p value in the drop down list box.
0-63	This field displays each DSCP value.
802.1p Priority	Use the drop down list box to select the IEEE 802.1p priority (0 to 7) to which you would like to map this DSCP value.
Apply	Click <b>Apply</b> to save your changes to the switch's run-time memory. The switch loses these changes if it is turned off or loses power, so use the <b>Save</b> link on the top navigation panel to save your changes to the non-volatile memory when you are done configuring.
Cancel	Click <b>Cancel</b> to reset the fields.



# CHAPTER 26

## Maintenance

This chapter explains how to configure the maintenance screens that let you maintain the firmware and configuration files.

### 26.1 The Maintenance Screen

Click **Management, Maintenance** in the navigation panel to open the following screen.

**Figure 85** Maintenance

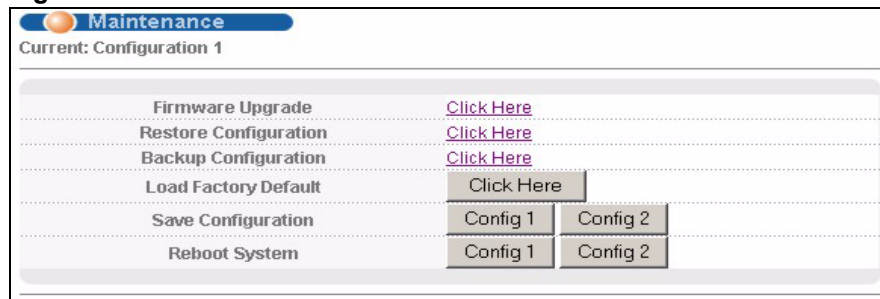

The following table describes the labels in this screen.

**Table 62** Maintenance

LABEL	DESCRIPTION
Current	This field displays which configuration ( <b>Configuration 1</b> or <b>Configuration 2</b> ) is currently operating on the switch.
Firmware Upgrade	Click <b>Click Here</b> to go to the <b>Firmware Upgrade</b> screen.
Restore Configuration	Click <b>Click Here</b> to go to the <b>Restore Configuration</b> screen.
Backup Configuration	Click <b>Click Here</b> to go to the <b>Backup Configuration</b> screen.
Load Factory Default	Click <b>Click Here</b> to reset the configuration to the factory default settings.

**Table 62** Maintenance (continued)

LABEL	DESCRIPTION
Save Configuration	Click <b>Config 1</b> to save the current configuration settings to <b>Configuration 1</b> on the switch. Click <b>Config 2</b> to save the current configuration settings to <b>Configuration 2</b> on the switch.
Reboot System	Click <b>Config 1</b> to reboot the system and load <b>Configuration 1</b> on the switch. Click <b>Config 2</b> to reboot the system and load <b>Configuration 2</b> on the switch.  <b>Note:</b> Make sure to click the <b>Save</b> button in any screen to save your settings to the current configuration on the switch.

## 26.2 Load Factory Defaults

Follow the steps below to reset the switch back to the factory defaults.

- 1 In the **Maintenance** screen, click the **Click Here** button next to **Load Factory Default** to clear all switch configuration information you configured and return to the factory defaults.
- 2 Click **OK** to reset all switch configurations to the factory defaults .

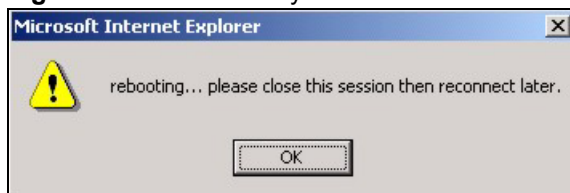
**Figure 86** Load Factory Default: Start

- 3 In the web configurator, click the **Save** button to make the changes take effect. If you want to access the switch web configurator again, you may need to change the IP address of your computer to be in the same subnet as that of the default switch IP address (192.168.1.1).

## 26.3 Save Configuration

Click **Config 1** to save the current configuration settings permanently to **Configuration 1** on the switch.

Click **Config 2** to save the current configuration settings to **Configuration 2** on the switch.

Alternatively, click **Save** on the top right-hand corner in any screen to save the configuration changes to the current configuration.

**Note:** Note: Clicking the **Apply** or **Add** button does NOT save the changes permanently.

All unsaved changes are erased after you reboot the switch.

## 26.4 Reboot System

**Reboot System** allows you to restart the switch without physically turning the power off. It also allows you to load configuration one (**Config 1**) or configuration two (**Config 2**) when you reboot. Follow the steps below to reboot the switch.

- 1 In the **Maintenance** screen, click the **Config 1** button next to **Reboot System** to reboot and load configuration one. The following screen displays.

**Figure 87** Reboot System: Confirmation



- 2 Click **OK** again and then wait for the switch to restart. This takes up to two minutes. This does not affect the switch's configuration.

Click **Config 2** and follow steps 1 to 2 to reboot and load configuration two on the switch.

## 26.5 Firmware Upgrade

Make sure you have downloaded (and unzipped) the correct model firmware and version to your computer before uploading to the device.

**Note:** Be sure to upload the correct model firmware as uploading the wrong model firmware may damage your device.

From the **Maintenance** screen, display the **Firmware Upgrade** screen as shown next.

**Figure 88** Firmware Upgrade

The screenshot shows a web interface for firmware upgrade. At the top, there is a blue header with an orange circle icon, the text 'Firmware Upgrade', and a purple link 'Maintenance'. Below the header is a light gray box containing the instruction: 'To upgrade the internal switch firmware, browse to the location of the binary (.BIN) file and click upgrade button.' Below this instruction is a 'File Path' label, a text input field, and a 'Browse...' button. At the bottom center of the interface is an 'Upgrade' button.

Type the path and file name of the firmware file you wish to upload to the switch in the **File Path** text box or click **Browse** to locate it. After you have specified the file, click **Upgrade**.

After the firmware upgrade process is complete, see the **System Info** screen to verify your current firmware version number.

## 26.6 Restore a Configuration File

Restore a previously saved configuration from your computer to the switch using the **Restore Configuration** screen.

**Figure 89** Restore Configuration

The screenshot shows a web interface for restoring configuration. At the top, there is a blue header with an orange circle icon, the text 'Restore Configuration', and a purple link 'Maintenance'. Below the header is a light gray box containing the instruction: 'To restore the device's configuration form a file, browse to the location of the configuration file and click Restore button.' Below this instruction is a 'File Path' label, a text input field, and a 'Browse...' button. At the bottom center of the interface is a 'Restore' button.

Type the path and file name of the configuration file you wish to restore in the **File Path** text box or click **Browse** to display the **Choose File** screen (below) from which you can locate it. After you have specified the file, click **Restore**. "config" is the name of the configuration file on the switch, so your backup configuration file is automatically renamed when you restore using this screen.

## 26.7 Backup a Configuration File

Backing up your switch configurations allows you to create various “snap shots” of your device from which you may restore at a later date.

Back up your current switch configuration to a computer using the **Backup Configuration** screen.

**Figure 90** Backup Configuration

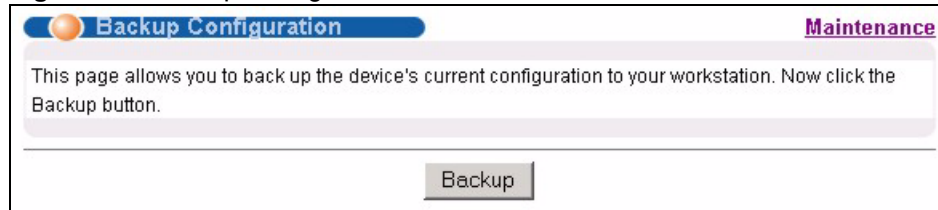

Follow the steps below to back up the current switch configuration to your computer in this screen.

- 1 Click **Backup**.
- 2 Click **Save** to display the **Save As** screen.
- 3 Choose a location to save the file on your computer from the **Save in** drop-down list box and type a descriptive name for it in the **File name** list box. Click **Save** to save the configuration file to your computer.

## 26.8 FTP Command Line

This section shows some examples of uploading to or downloading files from the switch using FTP commands. First, understand the filename conventions.

### 26.8.1 Filename Conventions

The configuration file (also known as the romfile or ROM) contains the factory default settings in the screens such as password, switch setup, IP Setup, etc. Once you have customized the switch's settings, they can be saved back to your computer under a filename of your choosing.

ZyNOS (ZyXEL Network Operating System sometimes referred to as the “ras” file) is the system firmware and has a “bin” filename extension.

**Table 63** Filename Conventions

FILE TYPE	INTERNAL NAME	EXTERNAL NAME	DESCRIPTION
Configuration File	config		This is the configuration filename on the switch. Uploading the config file replaces the specified configuration file system, including your switch configurations, system-related data (including the default password), the error log and the trace log.
Firmware	ras	*.bin	This is the generic name for the ZyNOS firmware on the switch.

### 26.8.1.1 Example FTP Commands

```
ftp> put firmware.bin ras
```

This is a sample FTP session showing the transfer of the computer file "firmware.bin" to the switch.

```
ftp> get config config.cfg
```

This is a sample FTP session saving the current configuration to a file called "config.cfg" on your computer.

If your (T)FTP client does not allow you to have a destination filename different than the source, you will need to rename them as the switch only recognizes "config" and "ras". Be sure you keep unaltered copies of both files for later use.

**Note:** Be sure to upload the correct model firmware as uploading the wrong model firmware may damage your device.

### 26.8.2 FTP Command Line Procedure

- 1 Launch the FTP client on your computer.
- 2 Enter `open`, followed by a space and the IP address of your switch.
- 3 Press [ENTER] when prompted for a username.
- 4 Enter your password as requested (the default is "1234").
- 5 Enter `bin` to set transfer mode to binary.
- 6 Use `put` to transfer files from the computer to the switch, for example, `put firmware.bin ras` transfers the firmware on your computer (firmware.bin) to the switch and renames it to "ras". Similarly, `put config.cfg config` transfers the configuration file on your computer (config.cfg) to the switch and renames it to "config". Likewise `get config config.cfg` transfers the configuration file on the switch to your computer and renames it to "config.cfg". See [Table 63 on page 191](#) for more information on filename conventions.
- 7 Enter `quit` to exit the ftp prompt.



### 26.8.3 GUI-based FTP Clients

The following table describes some of the commands that you may see in GUI-based FTP clients.

**Table 64** General Commands for GUI-based FTP Clients

COMMAND	DESCRIPTION
Host Address	Enter the address of the host server.
Login Type	Anonymous. This is when a user I.D. and password is automatically supplied to the server for anonymous access. Anonymous logins will work only if your ISP or service administrator has enabled this option. Normal. The server requires a unique User ID and Password to login.
Transfer Type	Transfer files in either ASCII (plain text format) or in binary mode. Configuration and firmware files should be transferred in binary mode.
Initial Remote Directory	Specify the default remote directory (path).
Initial Local Directory	Specify the default local directory (path).

### 26.8.4 FTP Restrictions

FTP will not work when:

- FTP service is disabled in the **Service Access Control** screen.
- The IP address(es) in the **Remote Management** screen does not match the client IP address. If it does not match, the switch will disconnect the Telnet session immediately.



# CHAPTER 27

## Access Control

This chapter describes how to control access to the switch.

### 27.1 Access Control Overview

A console port and FTP are allowed one session each, Telnet and SSH share four sessions, up to five Web sessions (five different usernames and passwords) and/or limitless SNMP access control sessions are allowed.

**Table 65** Access Control Overview

Console Port	SSH	Telnet	FTP	Web	SNMP
One session	Share up to four sessions		One session	Up to five accounts	No limit

A console port access control session and Telnet access control session cannot coexist when multi-login is disabled. See [Section 34.11.2 on page 238](#) for more information on disabling multi-login.

### 27.2 The Access Control Main Screen

Click **Management, Access Control** in the navigation panel to display the main screen as shown.

**Figure 91** Access Control



## 27.3 About SNMP

Simple Network Management Protocol (SNMP) is an application layer protocol used to manage and monitor TCP/IP-based devices. SNMP is used to exchange management information between the network management system (NMS) and a network element (NE). A manager station can manage and monitor the switch through the network via SNMP version one (SNMPv1) and/or SNMP version 2c. The next figure illustrates an SNMP management operation. SNMP is only available if TCP/IP is configured.

**Figure 92** SNMP Management Model

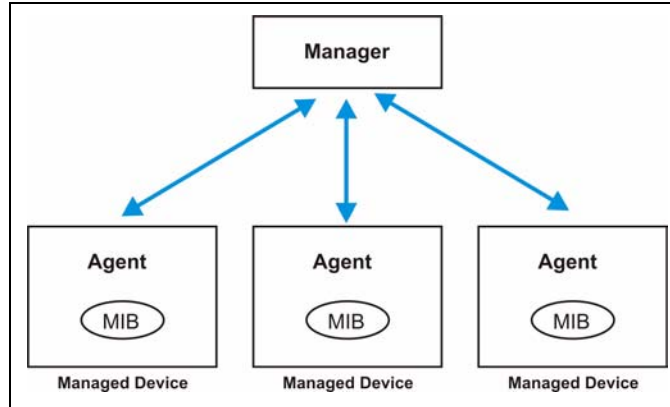

An SNMP managed network consists of two main components: agents and a manager.

An agent is a management software module that resides in a managed switch (the switch). An agent translates the local management information from the managed switch into a form compatible with SNMP. The manager is the console through which network administrators perform network management functions. It executes applications that control and monitor managed devices.

The managed devices contain object variables/managed objects that define each piece of information to be collected about a switch. Examples of variables include such as number of packets received, node port status etc. A Management Information Base (MIB) is a collection of managed objects. SNMP allows a manager and agents to communicate for the purpose of accessing these objects.

SNMP itself is a simple request/response protocol based on the manager/agent model. The manager issues a request and the agent returns responses using the following protocol operations:

**Table 66** SNMP Commands

COMMAND	DESCRIPTION
Get	Allows the manager to retrieve an object variable from the agent.
GetNext	Allows the manager to retrieve the next object variable from a table or list within an agent. In SNMPv1, when a manager wants to retrieve all elements of a table from an agent, it initiates a Get operation, followed by a series of GetNext operations.

**Table 66** SNMP Commands

COMMAND	DESCRIPTION
Set	Allows the manager to set values for object variables within an agent.
Trap	Used by the agent to inform the manager of some events.

### 27.3.1 Supported MIBs

MIBs let administrators collect statistics and monitor status and performance.

The switch supports the following MIBs:

- SNMP MIB II (RFC 1213)
- RFC 1157 SNMP v1
- RFC 1493 Bridge MIBs
- RFC 1643 Ethernet MIBs
- RFC 1155 SMI
- RFC 2674 SNMPv2, SNMPv2c
- RFC 1757 RMON
- SNMPv2, SNMPv2c or later version, compliant with RFC 2011 SNMPv2 MIB for IP, RFC 2012 SNMPv2 MIB for TCP, RFC 2013 SNMPv2 MIB for UDP

### 27.3.2 SNMP Traps

The switch sends traps to an SNMP manager when an event occurs. SNMP traps supported are outlined in the following table.

**Table 67** SNMP Traps

OBJECT LABEL	OBJECT ID	DESCRIPTION
SNMPv2 Traps		
Cold Start	1.3.6.1.6.3.1.1.5.1	This trap is sent when the switch is turned on.
WarmStart	1.3.6.1.6.3.1.1.5.2	This trap is sent when the switch restarts.
linkDown	1.3.6.1.6.3.1.1.5.3	This trap is sent when the Ethernet link is down.
linkUp	1.3.6.1.6.3.1.1.5.4	This trap is sent when the Ethernet link is up.
authenticationFailure	1.3.6.1.6.3.1.1.5.5	This trap is sent when an SNMP request comes from non-authenticated hosts.
RFC 1493 Traps		
newRoot	1.3.6.1.2.1.17.0.1	This trap is sent when the STP topology changes.
topology change	1.3.6.1.2.1.17.0.2	This trap is sent when the STP root switch changes.

### 27.3.3 Configuring SNMP

From the **Access Control** screen, display the **SNMP** screen. You can click **Access Control** to go back to the **Access Control** screen.

**Figure 93** Access Control: SNMP

The following table describes the labels in this screen.

**Table 68** Access Control: SNMP

LABEL	DESCRIPTION
Get Community	Enter the get community, which is the password for the incoming Get- and GetNext-requests from the management station.
Set Community	Enter the set community, which is the password for incoming Set- requests from the management station.
Trap Community	Enter the trap community, which is the password sent with each trap to the SNMP manager.
Trap Destination	Enter the IP addresses of up to four stations to send your SNMP traps to.
Apply	Click <b>Apply</b> to save your changes to the switch's run-time memory. The switch loses these changes if it is turned off or loses power, so use the <b>Save</b> link on the top navigation panel to save your changes to the non-volatile memory when you are done configuring.
Cancel	Click <b>Cancel</b> to reset the fields.

### 27.3.4 Setting Up Login Accounts

Up to five people (one administrator and four non-administrators) may access the switch via web configurator at any one time.

- An administrator is someone who can both view and configure switch changes. The username for the Administrator is always **admin**. The default administrator password is **1234**.

**Note:** It is highly recommended that you change the default administrator password (**1234**).

- A non-administrator (username is something other than **admin**) is someone who can view but not configure switch settings.

Click **Access Control** from the navigation panel and then click **Logins** from this screen.

**Figure 94** Access Control: Logins

The following table describes the labels in this screen.

**Table 69** Access Control: Logins

LABEL	DESCRIPTION
Administrator	This is the default administrator account with the “admin” user name. You cannot change the default administrator user name. Only the administrator has read/write access.
Old Password	Type the existing system password ( <b>1234</b> is the default password when shipped).
New Password	Enter your new system password.
Retype to confirm	Retype your new system password for confirmation
Edit Logins	You may configure passwords for up to four users. These users have read-only access. You can give users higher privileges via the CLI. For more information on assigning privileges see <a href="#">Chapter 34 on page 229</a> .
User Name	Set a user name (up to 32 ASCII characters long).
Password	Enter your new system password.
Retype to confirm	Retype your new system password for confirmation

**Table 69** Access Control: Logins (continued)

LABEL	DESCRIPTION
Apply	Click <b>Apply</b> to save your changes to the switch's run-time memory. The switch loses these changes if it is turned off or loses power, so use the <b>Save</b> link on the top navigation panel to save your changes to the non-volatile memory when you are done configuring.
Cancel	Click <b>Cancel</b> to reset the fields.

## 27.4 SSH Overview

Unlike Telnet or FTP, which transmit data in clear text, SSH (Secure Shell) is a secure communication protocol that combines authentication and data encryption to provide secure encrypted communication

between two hosts over an unsecured network.

**Figure 95** SSH Communication Example

## 27.5 How SSH works

The following table summarizes how a secure connection is established between two remote hosts.

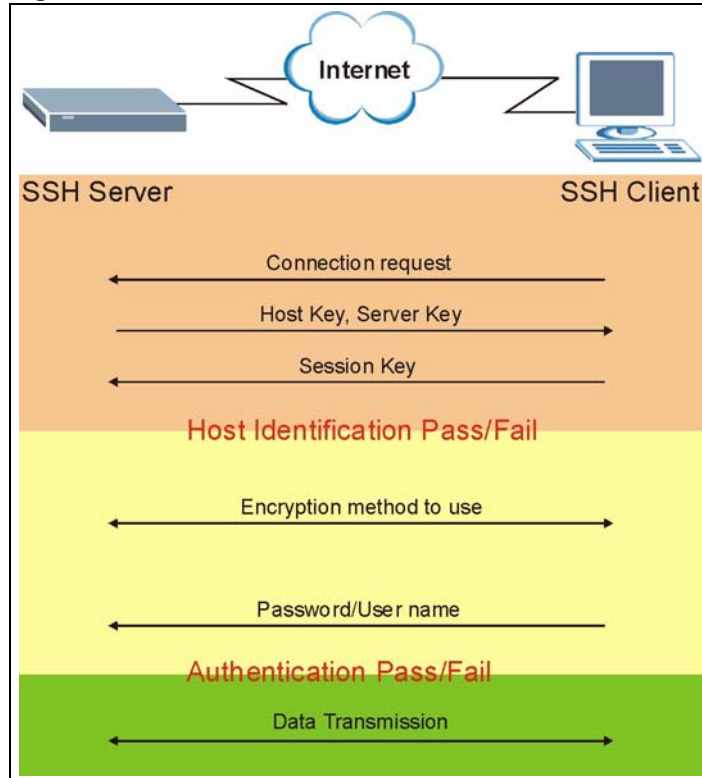

**Figure 96** How SSH Works**1 Host Identification**

The SSH client sends a connection request to the SSH server. The server identifies itself with a host key. The client encrypts a randomly generated session key with the host key and server key and sends the result back to the server.

The client automatically saves any new server public keys. In subsequent connections, the server public key is checked against the saved version on the client computer.

**2 Encryption Method**

Once the identification is verified, both the client and server must agree on the type of encryption method to use.

**3 Authentication and Data Transmission**

After the identification is verified and data encryption activated, a secure tunnel is established between the client and the server. The client then sends its authentication information (user name and password) to the server to log in to the server.

## 27.6 SSH Implementation on the Switch

Your switch supports SSH version 2 using RSA authentication and three encryption methods (DES, 3DES and Blowfish). The SSH server is implemented on the switch for remote management and file transfer on port 22. Only one SSH connection is allowed at a time.

## 27.6.1 Requirements for Using SSH

You must install an SSH client program on a client computer (Windows or Linux operating system) that is used to connect to the switch over SSH.

## 27.7 Introduction to HTTPS

HTTPS (HyperText Transfer Protocol over Secure Socket Layer, or HTTP over SSL) is a web protocol that encrypts and decrypts web pages. Secure Socket Layer (SSL) is an application-level protocol that enables secure transactions of data by ensuring confidentiality (an unauthorized party cannot read the transferred data), authentication (one party can identify the other party) and data integrity (you know if data has been changed).

It relies upon certificates, public keys, and private keys.

HTTPS on the switch is used so that you may securely access the switch using the web configurator. The SSL protocol specifies that the SSL server (the switch) must always authenticate itself to the SSL client (the computer which requests the HTTPS connection with the switch), whereas the SSL client only should authenticate itself when the SSL server requires it to do so. Authenticating client certificates is optional and if selected means the SSL-client must send the switch a certificate. You must apply for a certificate for the browser from a CA that is a trusted CA on the switch.

Please refer to the following figure.

- 1 HTTPS connection requests from an SSL-aware web browser go to port 443 (by default) on the switch's WS (web server).
- 2 HTTP connection requests from a web browser go to port 80 (by default) on the switch's WS (web server).

**Figure 97** HTTPS Implementation

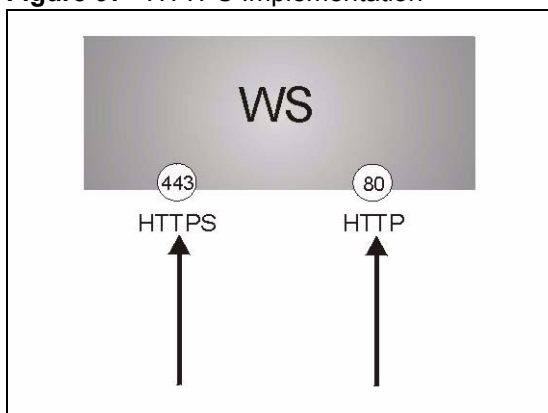

**Note:** If you disable **HTTP** in the **Service Access Control** screen, then the switch blocks all HTTP connection attempts.

## 27.8 HTTPS Example

If you haven't changed the default HTTPS port on the switch, then in your browser enter "https://switch IP Address/" as the web site address where "switch IP Address" is the IP address or domain name of the switch you wish to access.

### 27.8.1 Internet Explorer Warning Messages

When you attempt to access the switch HTTPS server, a Windows dialog box pops up asking if you trust the server certificate. Click **View Certificate** if you want to verify that the certificate is from the switch.

You see the following **Security Alert** screen in Internet Explorer. Select **Yes** to proceed to the web configurator login screen; if you select **No**, then web configurator access is blocked.

**Figure 98** Security Alert Dialog Box (Internet Explorer)

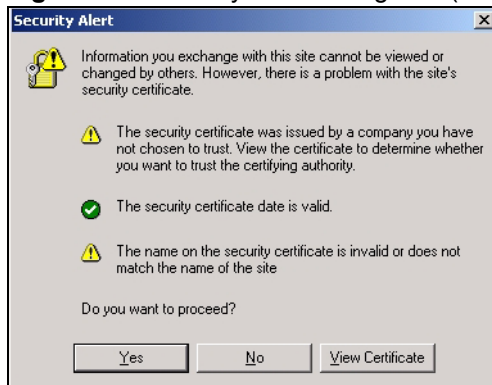

### 27.8.2 Netscape Navigator Warning Messages

When you attempt to access the switch HTTPS server, a **Website Certified by an Unknown Authority** screen pops up asking if you trust the server certificate. Click **Examine Certificate** if you want to verify that the certificate is from the switch.

If **Accept this certificate temporarily for this session** is selected, then click **OK** to continue in Netscape.

Select **Accept this certificate permanently** to import the switch's certificate into the SSL client.

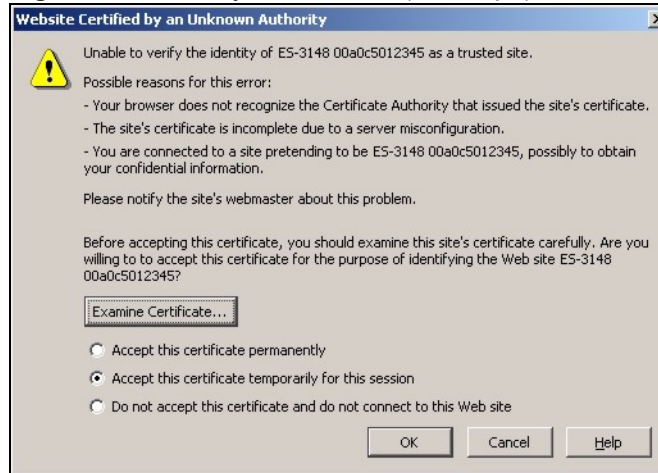
**Figure 99** Security Certificate 1 (Netscape)**Figure 100** Security Certificate 2 (Netscape)

### 27.8.3 The Main Screen

After you accept the certificate and enter the login username and password, the switch main screen appears. A lock displayed in the bottom right of the browser status bar denotes a secure connection.

Figure 101 Example: Lock Denoting a Secure Connection

The screenshot shows the ZyXEL Web Configurator interface in Microsoft Internet Explorer. The browser address bar shows the URL `https://172.23.37.240`. The interface includes a navigation menu on the left with options like Basic Setting, Advanced Application, IP Application, and Management. The main content area displays the 'Port Status' table, which lists 20 ports with their respective states and statistics. A red circle highlights a lock icon in the browser's status bar at the bottom right, indicating a secure connection.

Port	Name	Link	State	LACP	TxPkts	RxPkts	Errors	Tx KB/s	Rx KB/s	Up Time
1		Down	STOP	Disabled	0	0	0	0.0	0.0	0:00:00
2	100MF	FORWARDING	STOP	Disabled	4729	3701	0	0.64	0.0	0:19:21
3		Down	STOP	Disabled	0	0	0	0.0	0.0	0:00:00
4	100MF	FORWARDING	STOP	Disabled	3224	4101	0	0.0	0.64	0:19:21
5		Down	STOP	Disabled	0	0	0	0.0	0.0	0:00:00
6		Down	STOP	Disabled	0	0	0	0.0	0.0	0:00:00
7		Down	STOP	Disabled	0	0	0	0.0	0.0	0:00:00
8		Down	STOP	Disabled	0	0	0	0.0	0.0	0:00:00
9		Down	STOP	Disabled	0	0	0	0.0	0.0	0:00:00
10		Down	STOP	Disabled	0	0	0	0.0	0.0	0:00:00
11		Down	STOP	Disabled	0	0	0	0.0	0.0	0:00:00
12		Down	STOP	Disabled	0	0	0	0.0	0.0	0:00:00
13		Down	STOP	Disabled	0	0	0	0.0	0.0	0:00:00
14		Down	STOP	Disabled	0	0	0	0.0	0.0	0:00:00
15		Down	STOP	Disabled	0	0	0	0.0	0.0	0:00:00
16		Down	STOP	Disabled	0	0	0	0.0	0.0	0:00:00
17		Down	STOP	Disabled	0	0	0	0.0	0.0	0:00:00
18		Down	STOP	Disabled	0	0	0	0.0	0.0	0:00:00
19		Down	STOP	Disabled	0	0	0	0.0	0.0	0:00:00
20		Down	STOP	Disabled	0	0	0	0.0	0.0	0:00:00

## 27.9 Service Port Access Control

Service Access Control allows you to decide what services you may use to access the switch. You may also change the default service port and configure “trusted computer(s)” for each service in the **Remote Management** screen (discussed later). Click **Access Control** to go back to the main **Access Control** screen.

**Figure 102** Access Control: Service Access Control

Services	Active	Service Port	Timeout
Telnet	<input checked="" type="checkbox"/>	23	
SSH	<input checked="" type="checkbox"/>	22	
FTP	<input checked="" type="checkbox"/>	21	
HTTP	<input checked="" type="checkbox"/>	80	3 Minutes
HTTPS	<input checked="" type="checkbox"/>	443	
ICMP	<input checked="" type="checkbox"/>		
SNMP	<input checked="" type="checkbox"/>		

The following table describes the fields in this screen.

**Table 70** Access Control: Service Access Control

LABEL	DESCRIPTION
Services	Services you may use to access the switch are listed here.
Active	Select this option for the corresponding services that you want to allow to access the switch.
Service Port	For Telnet, SSH, FTP, HTTP or HTTPS services, you may change the default service port by typing the new port number in the <b>Server Port</b> field. If you change the default port number then you will have to let people (who wish to use the service) know the new port number for that service.
Timeout	Type how many minutes a management session (via the web configurator) can be left idle before the session times out. After it times out you have to log in with your password again. Very long idle timeouts may have security risks.
Apply	Click <b>Apply</b> to save your changes to the switch's run-time memory. The switch loses these changes if it is turned off or loses power, so use the <b>Save</b> link on the top navigation panel to save your changes to the non-volatile memory when you are done configuring.
Cancel	Click <b>Cancel</b> to reset the fields.

## 27.10 Remote Management

From the **Access Control** screen, display the **Remote Management** screen as shown next.

You can specify a group of one or more “trusted computers” from which an administrator may use a service to manage the switch. Click **Access Control** to return to the **Access Control** screen.

**Figure 103** Access Control: Remote Management

Entry	Active	Start Address	End Address	Telnet	FTP	HTTP	ICMP	SNMP	SSH	HTTPS
1	<input checked="" type="checkbox"/>	0.0.0.0	0.0.0.0	<input checked="" type="checkbox"/>	<input checked="" type="checkbox"/>	<input checked="" type="checkbox"/>	<input checked="" type="checkbox"/>	<input checked="" type="checkbox"/>	<input checked="" type="checkbox"/>	<input checked="" type="checkbox"/>
2	<input type="checkbox"/>	0.0.0.0	0.0.0.0	<input type="checkbox"/>	<input type="checkbox"/>	<input type="checkbox"/>	<input type="checkbox"/>	<input type="checkbox"/>	<input type="checkbox"/>	<input type="checkbox"/>
3	<input type="checkbox"/>	0.0.0.0	0.0.0.0	<input type="checkbox"/>	<input type="checkbox"/>	<input type="checkbox"/>	<input type="checkbox"/>	<input type="checkbox"/>	<input type="checkbox"/>	<input type="checkbox"/>
4	<input type="checkbox"/>	0.0.0.0	0.0.0.0	<input type="checkbox"/>	<input type="checkbox"/>	<input type="checkbox"/>	<input type="checkbox"/>	<input type="checkbox"/>	<input type="checkbox"/>	<input type="checkbox"/>

Apply Cancel

The following table describes the labels in this screen.

**Table 71** Access Control: Remote Management

LABEL	DESCRIPTION
Entry	This is the client set index number. A “client set” is a group of one or more “trusted computers” from which an administrator may use a service to manage the switch.
Active	Select this check box to activate this secured client set. Clear the check box if you wish to temporarily disable the set without deleting it.
Start Address End Address	Configure the IP address range of trusted computers from which you can manage this switch. The switch checks if the client IP address of a computer requesting a service or protocol matches the range set here. The switch immediately disconnects the session if it does not match.
Telnet/FTP/ HTTP/ICMP/ SNMP/SSH/ HTTPS	Select services that may be used for managing the switch from the specified trusted computers.
Apply	Click <b>Apply</b> to save your changes to the switch’s run-time memory. The switch loses these changes if it is turned off or loses power, so use the <b>Save</b> link on the top navigation panel to save your changes to the non-volatile memory when you are done configuring.
Cancel	Click <b>Cancel</b> to reset the fields.





# CHAPTER 28

## Diagnostic

This chapter explains the **Diagnostic** screen.

### 28.1 Diagnostic

Click **Management, Diagnostic** in the navigation panel to open this screen. Use this screen to check system logs, ping IP addresses or perform port tests.

**Figure 104** Diagnostic

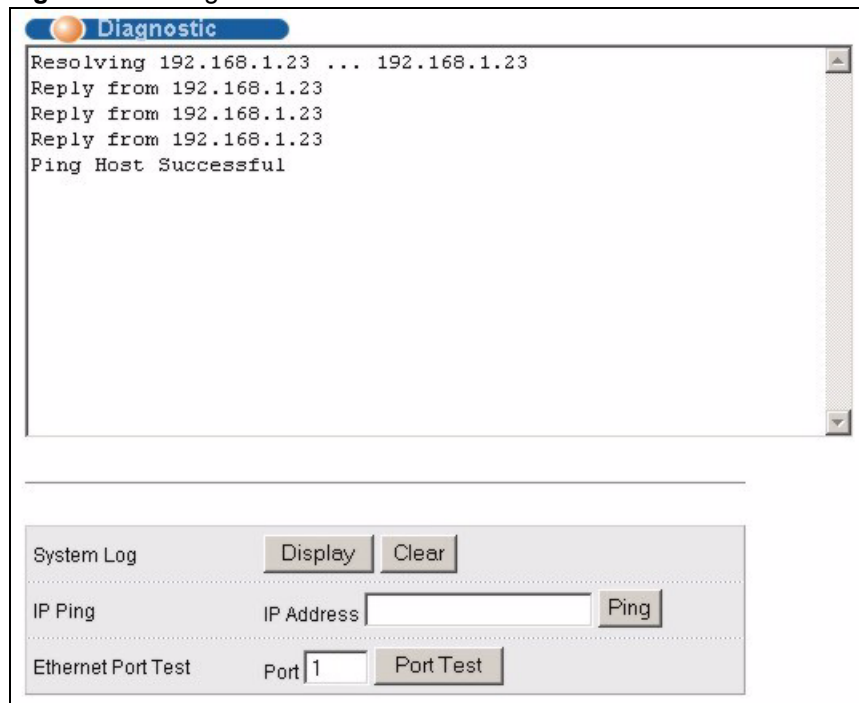

The following table describes the labels in this screen.

**Table 72** Diagnostic

LABEL	DESCRIPTION
System Log	Click <b>Display</b> to display a log of events in the multi-line text box. Click <b>Clear</b> to empty the text box and reset the syslog entry.
IP Ping	Type the IP address of a device that you want to ping in order to test a connection. Click <b>Ping</b> to have the switch ping the IP address (in the field to the left).
Ethernet Port Test	Enter a port number and click <b>Port Test</b> to perform an internal loopback test.



# CHAPTER 29

## Syslog

This chapter explains the syslog screens.

### 29.1 Syslog Overview

The syslog protocol allows devices to send event notification messages across an IP network to syslog servers that collect the event messages. A syslog-enabled device can generate a syslog message and send it to a syslog server.

Syslog is defined in RFC 3164. The RFC defines the packet format, content and system log related information of syslog messages. Each syslog message has a facility and severity level. The syslog facility identifies a file in the syslog server. Refer to the documentation of your syslog program for details. The following table describes the syslog severity levels.

**Table 73** Syslog Severity Levels

CODE	SEVERITY
0	Emergency: The system is unusable.
1	Alert: Action must be taken immediately.
2	Critical: The system condition is critical.
3	Error: There is an error condition on the system.
4	Warning: There is a warning condition on the system.
5	Notice: There is a normal but significant condition on the system.
6	Informational: The syslog contains an informational message.
7	Debug: The message is intended for debug-level purposes.

### 29.2 Syslog Setup

Click **Management** and then **Syslog** in the navigation panel to display this screen. The syslog feature sends logs to an external syslog server. Use this screen to configure the device's system logging settings.

**Figure 105** Syslog

Logging type	Active	Facility
System	<input type="checkbox"/>	local use 0
Interface	<input type="checkbox"/>	local use 0
Switch	<input type="checkbox"/>	local use 0
Authentication	<input type="checkbox"/>	local use 0
IP	<input type="checkbox"/>	local use 0

The following table describes the labels in this screen.

**Table 74** Syslog

LABEL	DESCRIPTION
Syslog	Select <b>Active</b> to turn on syslog (system logging) and then configure the syslog setting
Logging Type	This column displays the names of the categories of logs that the device can generate.
Active	Select this option to set the device to generate logs for the corresponding category.
Facility	The log facility allows you to send logs to different files in the syslog server. Refer to the documentation of your syslog program for more details.
Apply	Click <b>Apply</b> to save your changes to the switch's run-time memory. The switch loses these changes if it is turned off or loses power, so use the <b>Save</b> link on the top navigation panel to save your changes to the non-volatile memory when you are done configuring.
Cancel	Click <b>Cancel</b> to reset the fields.

## 29.3 Syslog Server Setup

Click **Management** and then **Syslog** in the navigation panel to display the **Syslog Setup** screen. Click the **Syslog Server Setup** link to open the following screen. Use this screen to configure a list of external syslog servers.

**Figure 106** Syslog: Server Setup

The following table describes the labels in this screen.

**Table 75** Syslog: Server Setup

LABEL	DESCRIPTION
Active	Select this check box to have the device send logs to this syslog server. Clear the check box if you want to create a syslog server entry but not have the device send logs to it (you can edit the entry later).
Server Address	Enter the IP address of the syslog server.
Log Level	Select the severity level(s) of the logs that you want the device to send to this syslog server. The lower the number, the more critical the logs are.
Add	Click <b>Add</b> to save your changes to the switch's run-time memory. The switch loses these changes if it is turned off or loses power, so use the <b>Save</b> link on the top navigation panel to save your changes to the non-volatile memory when you are done configuring.
Cancel	Click <b>Cancel</b> to reset the fields.
Clear	Click <b>Clear</b> to return the fields to the factory defaults.
Index	This is the index number of a syslog server entry. Click this number to edit the entry.
Active	This field displays <b>Yes</b> if the device is to send logs to the syslog server. <b>No</b> displays if the device is not to send logs to the syslog server.
IP Address	This field displays the IP address of the syslog server.
Log Level	This field displays the severity level of the logs that the device is to send to this syslog server.
Delete	Select an entry's <b>Delete</b> check box and click <b>Delete</b> to remove the entry.
Cancel	Click <b>Cancel</b> to reset the fields.



# CHAPTER 30

## Cluster Management

This chapter introduces cluster management.

### 30.1 Cluster Management Status Overview

Cluster Management allows you to manage switches through one switch, called the cluster manager. The switches must be directly connected and be in the same VLAN group so as to be able to communicate with one another.

**Table 76** ZyXEL Clustering Management Specifications

Maximum number of cluster members	24
Cluster Member Models	Must be compatible with ZyXEL cluster management implementation.
Cluster Manager	The switch through which you manage the cluster member switches.
Cluster Members	The switches being managed by the cluster manager switch.

In the following example, switch **A** in the basement is the cluster manager and the other switches on the upper floors of the building are cluster members.

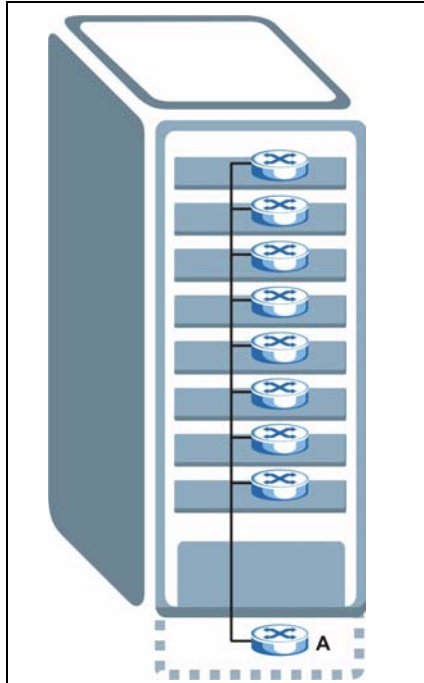
**Figure 107** Clustering Application Example

## 30.2 Cluster Management Status

Click **Management, Cluster Management** in the navigation panel to display the following screen.

**Note:** A cluster can only have one manager.



**Figure 108** Cluster Management: Status

Clustering Management Status		Configuration		
Status	Manager			
Manager	00:13:49:00:00:02			
The Number Of Member = 1				
Index	MacAddr	Name	Model	Status
<a href="#">1</a>	00:a0:c5:01:23:46		GS-2024	Online

The following table describes the labels in this screen.

**Table 77** Cluster Management: Status

LABEL	DESCRIPTION
Status	This field displays the role of this switch within the cluster. <b>Manager</b> <b>Member</b> (you see this if you access this screen in the cluster member switch directly and not via the cluster manager) <b>None</b> (neither a manager nor a member of a cluster)
Manager	This field displays the cluster manager switch's hardware MAC address.
The Number of Member	This field displays the number of switches that make up this cluster. The following fields describe the cluster member switches.
Index	You can manage cluster member switches via the cluster manager switch. Each number in the <b>Index</b> column is a hyperlink leading to the cluster member switch's web configurator (see <a href="#">Figure 109 on page 218</a> ).
MacAddr	This is the cluster member switch's hardware MAC address.
Name	This is the cluster member switch's <b>System Name</b> .
Model	This field displays the model name.
Status	This field displays: <b>Online</b> (the cluster member switch is accessible) <b>Error</b> (for example the cluster member switch password was changed or the switch was set as the manager and so left the member list, etc.) <b>Offline</b> (the switch is disconnected - <b>Offline</b> shows approximately 1.5 minutes after the link between cluster member and manager goes down)

### 30.2.1 Cluster Member Switch Management

Go to the **Clustering Management Status** screen of the cluster manager switch and then select an **Index** hyperlink from the list of members to go to that cluster member switch's web configurator home page. This cluster member web configurator home page and the home page that you'd see if you accessed it directly are different.

**Figure 109** Cluster Management: Cluster Member Web Configurator Screen

### 30.2.1.1 Uploading Firmware to a Cluster Member Switch

You can use FTP to upload firmware to a cluster member switch through the cluster manager switch as shown in the following example.

**Figure 110** Example: Uploading Firmware to a Cluster Member Switch

```

C:\>ftp 192.168.1.1
Connected to 192.168.1.1.
220 ES-3148 FTP version 1.0 ready at Thu Jan  1 00:58:46 1970
User (192.168.0.1:(none)): admin
331 Enter PASS command
Password:
230 Logged in
ftp> ls
200 Port command okay
150 Opening data connection for LIST
--w--w--w-  1 owner   group           3042210 Jul  01 12:00 ras
-rw-rw-rw-  1 owner   group           393216  Jul  01 12:00 config
--w--w--w-  1 owner   group              0 Jul  01 12:00 fw-00-a0-c5-01-23-46
-rw-rw-rw-  1 owner   group              0 Jul  01 12:00 config-00-a0-c5-01-23-46
226 File sent OK
ftp: 297 bytes received in 0.00Seconds 297000.00Kbytes/sec.
ftp> bin
200 Type I OK
ftp> put 3701t0.bin fw-00-a0-c5-01-23-46
200 Port command okay
150 Opening data connection for STOR fw-00-a0-c5-01-23-46
226 File received OK
ftp: 262144 bytes sent in 0.63Seconds 415.44Kbytes/sec.
ftp>

```

The following table explains some of the FTP parameters.

**Table 78** FTP Upload to Cluster Member Example

FTP PARAMETER	DESCRIPTION
User	Enter "admin".
Password	The web configurator password default is 1234.
ls	Enter this command to list the name of cluster member switch's firmware and configuration file.
3601t0.bin	This is the name of the firmware file you want to upload to the cluster member switch.
fw-00-a0-c5-01-23-46	This is the cluster member switch's firmware name as seen in the cluster manager switch.
config-00-a0-c5-01-23-46	This is the cluster member switch's configuration file name as seen in the cluster manager switch.

### 30.3 Clustering Management Configuration

Use this screen to configure clustering management. Click **Configuration** from the **Cluster Management** screen to display the next screen.

**Figure 111** Clustering Management Configuration

The following table describes the labels in this screen.

**Table 79** Clustering Management Configuration

LABEL	DESCRIPTION
Clustering Manager	
Active	Select <b>Active</b> to have this switch become the cluster manager switch. A cluster can only have one manager. Other (directly connected) switches that are set to be cluster managers will not be visible in the <b>Clustering Candidates</b> list. If a switch that was previously a cluster member is later set to become a cluster manager, then its <b>Status</b> is displayed as <b>Error</b> in the <b>Cluster Management Status</b> screen and a warning icon ( ⚠ ) appears in the member summary list below.
Name	Type a name to identify the <b>Clustering Manager</b> . You may use up to 32 printable characters (spaces are allowed).
VID	This is the VLAN ID and is only applicable if the switch is set to <b>802.1Q</b> VLAN. All switches must be directly connected and in the same VLAN group to belong to the same cluster. Switches that are not in the same VLAN group are not visible in the <b>Clustering Candidates</b> list. This field is ignored if the <b>Clustering Manager</b> is using <b>Port-based</b> VLAN.

**Table 79** Clustering Management Configuration (continued)

LABEL	DESCRIPTION
Apply	Click <b>Apply</b> to save your changes to the switch's run-time memory. The switch loses these changes if it is turned off or loses power, so use the <b>Save</b> link on the top navigation panel to save your changes to the non-volatile memory when you are done configuring.
Cancel	Click <b>Cancel</b> to reset the fields.
Clustering Candidate	The following fields relate to the switches that are potential cluster members.
List	A list of suitable candidates found by auto-discovery is shown here. The switches must be directly connected. Directly connected switches that are set to be cluster managers will not be visible in the <b>Clustering Candidate</b> list. Switches that are not in the same management VLAN group will not be visible in the <b>Clustering Candidate</b> list.
Password	Each cluster member's password is its web configurator password. Select a member in the <b>Clustering Candidate</b> list and then enter its web configurator password. If that switch administrator changes the web configurator password afterwards, then it cannot be managed from the <b>Cluster Manager</b> . Its <b>Status</b> is displayed as <b>Error</b> in the <b>Cluster Management Status</b> screen and a warning icon (  ) appears in the member summary list below. If multiple devices have the same password then hold [SHIFT] and click those switches to select them. Then enter their common web configurator password.
Add	Click <b>Add</b> to save this part of the screen to the switch.
Cancel	Click <b>Cancel</b> to reset the fields.
Refresh	Click <b>Refresh</b> to perform auto-discovery again to list potential cluster members.
The next summary table shows the information for the clustering members configured.	
Index	This is the index number of a cluster member switch.
MacAddr	This is the cluster member switch's hardware MAC address.
Name	This is the cluster member switch's <b>System Name</b> .
Model	This is the cluster member switch's model name.
Remove	Select this checkbox and then click the <b>Remove</b> button to remove a cluster member switch from the cluster.
Cancel	Click <b>Cancel</b> to reset the fields.



# CHAPTER 31

## MAC Table

This chapter introduces the **MAC Table** screen.

### 31.1 MAC Table Overview

The **MAC Table** screen (a MAC table is also known as a filtering database) shows how frames are forwarded or filtered across the switch's ports. It shows what device MAC address, belonging to what VLAN group (if any) is forwarded to which port(s) and whether the MAC address is dynamic (learned by the switch) or static (manually entered in the **Static MAC Forwarding** screen).

The switch uses the MAC table to determine how to forward frames. See the following figure.

- 1 The switch examines a received frame and learns the port on which this source MAC address came.
- 2 The switch checks to see if the frame's destination MAC address matches a source MAC address already learned in the MAC table.
  - If the switch has already learned the port for this MAC address, then it forwards the frame to that port.
  - If the switch has not already learned the port for this MAC address, then the frame is flooded to all ports. Too much port flooding leads to network congestion.
  - If the switch has already learned the port for this MAC address, but the destination port is the same as the port it came in on, then it filters the frame.

**Figure 112** MAC Table Flowchart

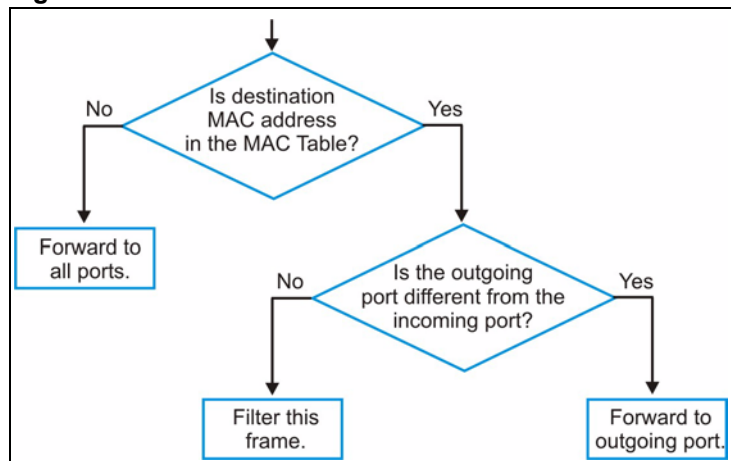

## 31.2 Viewing the MAC Table

Click **Management, MAC Table** in the navigation panel to display the following screen.

**Figure 113** MAC Table

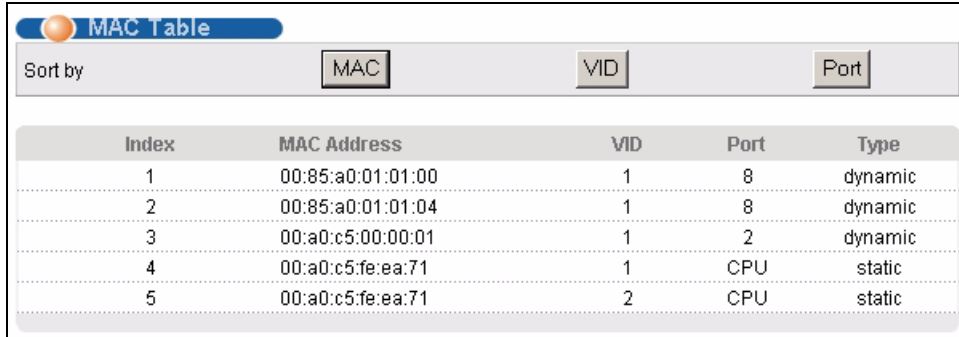

Index	MAC Address	VID	Port	Type
1	00:85:a0:01:01:00	1	8	dynamic
2	00:85:a0:01:01:04	1	8	dynamic
3	00:a0:c5:00:00:01	1	2	dynamic
4	00:a0:c5:fe:ea:71	1	CPU	static
5	00:a0:c5:fe:ea:71	2	CPU	static

The following table describes the labels in this screen.

**Table 80** MAC Table

LABEL	DESCRIPTION
Sort by	Click one of the following buttons to display and arrange the data according to that button type. The information is then displayed in the summary table below.
MAC	Click this button to display and arrange the data according to MAC address.
VID	Click this button to display and arrange the data according to VLAN group.
Port	Click this button to display and arrange the data according to port number.
Index	This is the incoming frame index number.
MAC Address	This is the MAC address of the device from which this incoming frame came.
VID	This is the VLAN group to which this frame belongs.
Port	This is the port from which the above MAC address was learned.
Type	This shows whether the MAC address is <b>dynamic</b> (learned by the switch) or <b>static</b> (manually entered in the <b>Static MAC Forwarding</b> screen).



# CHAPTER 32

## ARP Table

This chapter introduces ARP Table.

### 32.1 ARP Table Overview

Address Resolution Protocol (ARP) is a protocol for mapping an Internet Protocol address (IP address) to a physical machine address, also known as a Media Access Control or MAC address, on the local area network.

An IP (version 4) address is 32 bits long. In an Ethernet LAN, MAC addresses are 48 bits long. The ARP Table maintains an association between each MAC address and its corresponding IP address.

#### 32.1.1 How ARP Works

When an incoming packet destined for a host device on a local area network arrives at the switch, the switch's ARP program looks in the ARP Table and, if it finds the address, sends it to the device.

If no entry is found for the IP address, ARP broadcasts the request to all the devices on the LAN. The switch fills in its own MAC and IP address in the sender address fields, and puts the known IP address of the target in the target IP address field. In addition, the switch puts all ones in the target MAC field (FF.FF.FF.FF.FF.FF is the Ethernet broadcast address). The replying device (which is either the IP address of the device being sought or the router that knows the way) replaces the broadcast address with the target's MAC address, swaps the sender and target pairs, and unicasts the answer directly back to the requesting machine. ARP updates the ARP Table for future reference and then sends the packet to the MAC address that replied.

### 32.2 Viewing the ARP Table

Click **Management, ARP Table** in the navigation panel to open the following screen. Use the ARP table to view IP-to-MAC address mapping(s).

**Figure 114** ARP Table

ARP Table			
Index	IP Address	MAC Address	Type
1	172.21.0.2	00:05:5d:04:30:f1	dynamic
2	172.21.3.16	00:05:1c:15:08:71	dynamic
3	172.21.3.19	00:0b:cd:8c:6d:ed	dynamic
4	172.21.3.40	00:0c:76:07:41:0d	dynamic
5	172.21.3.66	00:50:8d:47:73:4f	dynamic
6	172.21.3.90	00:05:5d:f4:49:20	dynamic
7	172.21.3.91	00:50:ba:ad:56:7c	dynamic
8	172.21.3.95	00:10:b5:ae:56:97	dynamic
9	172.21.3.120	00:10:b5:ae:62:32	dynamic
10	172.21.3.138	00:a0:c5:b2:62:26	dynamic
11	172.21.4.99	00:0c:76:09:cf:88	dynamic
12	172.21.10.11	08:00:20:ad:f6:88	dynamic
13	172.21.100.153	00:90:27:be:a2:8c	dynamic
14	172.21.207.247	00:0c:76:09:17:1a	dynamic
15	192.168.1.1	00:a0:c5:3f:91:56	dynamic
16	192.168.1.5	00:85:a0:01:01:04	dynamic
17	192.168.1.10	00:a0:c5:5e:df:f9	static
18	192.168.1.100	00:85:a0:01:01:00	dynamic

The following table describes the labels in this screen.

**Table 81** ARP Table

LABEL	DESCRIPTION
Index	This is the ARP Table entry number.
IP Address	This is the learned IP address of a device connected to a switch port with corresponding MAC address below.
MAC Address	This is the MAC address of the device with corresponding IP address above.
Type	This shows whether the MAC address is dynamic (learned by the switch) or static (manually entered in the <b>Static MAC Forwarding</b> screen).

# CHAPTER 33

## Configure Clone

This chapter shows you how you can copy the settings of one port onto other ports.

### 33.1 Configure Clone

Cloning allows you to copy the basic and advanced settings from a source port to a destination port or ports. Click **Management, Configure Clone** to open the following screen.

**Figure 115** Configure Clone

The screenshot shows the 'Configure Clone' web interface. At the top, there is a title bar with a red circle icon and the text 'Configure Clone'. Below the title bar, there are two input fields labeled 'Source' and 'Destination', with a 'Port' label to the left of the 'Source' field. Below these fields is a section titled 'Port Features' which is divided into two main categories: 'Basic Setting' and 'Advanced Application'. Each category contains a list of features with checkboxes. The 'Basic Setting' category includes: Active, Name, Speed / Duplex, BPDU Control, Flow Control, and Intrusion Lock. The 'Advanced Application' category includes: VLAN1q, VLAN1q Member, Bandwidth Control, VLAN Stacking, Port Security, Broadcast Storm Control, Mirroring, Port Authentication, Queuing Method, IGMP Filtering, Spanning Tree Protocol, Multiple Rapid Spanning Tree Protocol, Protocol-based VLAN, and Port-based VLAN. At the bottom of the interface, there are two buttons: 'Apply' and 'Cancel'.

Category	Feature	Checked
Basic Setting	Active	<input type="checkbox"/>
	Name	<input type="checkbox"/>
	Speed / Duplex	<input type="checkbox"/>
	BPDU Control	<input type="checkbox"/>
	Flow Control	<input type="checkbox"/>
	Intrusion Lock	<input type="checkbox"/>
Advanced Application	VLAN1q	<input type="checkbox"/>
	VLAN1q Member	<input type="checkbox"/>
	Bandwidth Control	<input type="checkbox"/>
	VLAN Stacking	<input type="checkbox"/>
	Port Security	<input type="checkbox"/>
	Broadcast Storm Control	<input type="checkbox"/>
	Mirroring	<input type="checkbox"/>
	Port Authentication	<input type="checkbox"/>
	Queuing Method	<input type="checkbox"/>
	IGMP Filtering	<input type="checkbox"/>
	Spanning Tree Protocol	<input type="checkbox"/>
	Multiple Rapid Spanning Tree Protocol	<input type="checkbox"/>
	Protocol-based VLAN	<input type="checkbox"/>
	Port-based VLAN	<input type="checkbox"/>

The following table describes the labels in this screen.

**Table 82** Configure Clone

LABEL	DESCRIPTION
Source/ Destination Port	Enter the source port under the <b>Source</b> label. This port's attributes are copied. Enter the destination port or ports under the <b>Destination</b> label. These are the ports which are going to have the same attributes as the source port. You can enter individual ports separated by a comma or a range of ports by using a dash. Example: <ul style="list-style-type: none"><li>• <b>2, 4, 6</b> indicates that ports 2, 4 and 6 are the destination ports.</li><li>• <b>2-6</b> indicates that ports 2 through 6 are the destination ports.</li></ul>
Basic Setting	Select which port settings (you configured in the <b>Basic Setting</b> menus) should be copied to the destination port(s).
Advanced Application	Select which port settings (you configured in the <b>Advanced Application</b> menus) should be copied to the destination ports.
Apply	Click <b>Apply</b> to save your changes to the switch's run-time memory. The switch loses these changes if it is turned off or loses power, so use the <b>Save</b> link on the top navigation panel to save your changes to the non-volatile memory when you are done configuring.
Cancel	Click <b>Cancel</b> to reset the fields.

# CHAPTER 34

## Introducing Commands

This chapter introduces commands and gives a summary of commands available.

### 34.1 Overview

In addition to the web configurator, you can use commands to configure the switch. Use commands for advanced switch diagnosis and troubleshooting. If you have problems with your switch, customer support may request that you issue some of these commands to assist them in troubleshooting.

**Note:** See the web configurator parts of this User's Guide for background information on features configurable by the web configurator.

### 34.2 Accessing the CLI

You can use a direct console connection or Telnet to access the command interpreter on the switch.

**Note:** The switch automatically logs you out of the management interface after five minutes of inactivity. If this happens to you, simply log back in again.

- By default, multiple command interpreter management sessions are allowed via either the console port or Telnet. However, no more than five concurrent login sessions are allowed.
- Use the `configure multi-login` command in the configuration mode to limit concurrent logins to one. Console port access has higher priority.

#### 34.2.1 The Console Port

Connect to the switch's console port using a terminal emulation software configured to the following settings:

- VT100 terminal emulation
- 9600 bps
- No parity
- 8 data bits
- 1 stop bit
- No flow control

### 34.2.1.1 Initial Screen

When you turn on your switch, it performs several internal tests as well as line initialization. You can view the initialization information using the console port. After the initialization, the login screen displays (refer to [Section 34.3 on page 230](#)).

```
Copyright (c) 1994 - 2006 ZyXEL Communications Corp.
initialize mgmt, ethernet address: 00:13:49:00:00:01
initialize switch, ethernet address: 00:13:49:00:00:02
Initializing switch unit 0...
Initializing VLAN Database...
Initializing IP Interface...
Initializing Advanced Applications...
Initializing Command Line Interface...
Initializing Web Interface...
Press ENTER to continue...
```

Use the following steps to telnet into your switch.

- 1 For local management, connect your computer to the RJ-45 management port (labeled **MGMT**) on the switch.
- 2 Make sure your computer IP address and the switch IP address are on the same subnet. In Windows, click **Start** (usually in the bottom left corner), **Run** and then type `telnet 192.168.0.1` (the default management IP address) and click **OK**.
- 3 A login screen displays (refer to [Section 34.3 on page 230](#)).

## 34.3 The Login Screen

After you have successfully established a connection to the switch using a direct console connection or Telnet, a login screen displays as shown below. For your first login, enter the default administrator login username “admin” and password “1234”.

```
User name: admin
Password: ****
```

## 34.4 Command Syntax Conventions

The rules of the commands are listed next.

- The command keywords are in `courier new` font.
- The required fields in a command are enclosed in angle brackets `<>`, for instance, `ping <ip>` means that you must specify an IP number for this command.

- The optional fields in a command are enclosed in square brackets [], for instance,
 

```
configure snmp-server [contact <system contact>] [location
<system location>]
```

 means that the contact and location fields are optional.
- “Command” refers to a command used in the command line interface (CLI command).
- The | symbol means “or”.
- The entry <cr> in the command lines refers to carriage return. Press [ENTER] or carriage return after a command to execute the command.
- Use the up or down arrow key to scroll through the command history list.
- You may enter a unique part of a command and press [TAB] to have the switch automatically display the full command. For example, if you enter “config” and press [TAB], the full command of “configure” automatically displays.
- Each interface refers to an Ethernet port on the switch. Commands configured after the interface command correspond to those ports.
- Type multiple ports or port ranges separated by a comma. Ranges of port numbers are typed separated by a dash.

## 34.5 Changing the Password

This command is used to change the password for Enable mode. By default the same password is used to enter the command line interface (CLI) and Enable and Config modes of the CLI.

The password you change with this command is required to enter Enable and Config modes of the CLI.

Syntax:

```
password <password>
```

where

`password <password>` = Specifies the new password (up to 32 alphanumeric characters) users have to type in to enter Enable and Config modes.

## 34.6 Privilege Levels

You can use a command whose privilege level is equal to or less than that of your login account. For example, if your login account has a privilege level of 12, you can use all commands with privilege levels from 0 to 12. 0 privilege level commands are available to all login accounts.

**Note:** If you use an external RADIUS server to authenticate users, you can use a VSA (Vendor Specific Attribute) to configure a privilege level for an account on the RADIUS server. See [Section 16.1.1.1 on page 131](#) for more information.

Use the following commands to specify privilege levels for login accounts.

Syntax:

```
logins username <username> password <password>
logins username <username> privilege <0-14>
```

where

<code>username &lt;username&gt;</code>	=	Specifies a new user (up to 32 alphanumeric characters). Enter a user name to change the settings of an existing account.
<code>password &lt;password&gt;</code>	=	Specifies the new password (up to 32 alphanumeric characters) for this user.
<code>privilege &lt;0-14&gt;</code>	=	Assigns a privilege level for the user.

## 34.7 Command Modes

There are three command modes: **User**, **Enable** and **Configure**. The modes (and commands) available to you depend on what level of privilege your account has. See [Section 34.6 on page 231](#) for more information on setting up privilege levels.

When you first log into the command interpreter with a read-only account (having a privilege of 0 to 12), the initial mode is the User mode. The User mode commands are a subset of Enable mode commands. The User mode command prompt ends with an angle bracket (>).

To enter Enable mode, type `enable` and enter the administrator password when prompted (the default is 1234). When you enter Enable mode, the command prompt changes to the pound sign (#). If you log into the command interpreter as an administrator you automatically enter Enable mode.



The following table describes command interpreter modes and how to access them.

**Table 83** Command Interpreter Mode Summary

MODE	DESCRIPTION	HOW TO LOGIN/ ACCESS	PROMPT
User	Commands available in this mode are a subset of enable mode. You can perform basic tests and display general system information.	Default login level for a read-only account.	sysname> The first part of the prompt is the system name. In the CLI examples in this User's Guide, the system name is always "sysname".
Enable	Commands available in this mode allow you to save configuration settings, reset configuration settings as well as display further system information. This mode also contains the <code>configure</code> command which takes you to config mode.	Default login level for accounts with a privilege of 13 or 14. Read-only accounts (with a privilege of 0-12) need to type the <code>enable</code> command and enter enable mode password.	sysname#
Config	Commands available in this mode allow you to configure settings that affect the switch globally.	Type <code>config</code> in enable mode.	sysname(config)#
Command modes that follow are sub-modes of the config mode and can only be accessed from within the config mode.			
Config-vlan	This is a sub-mode of the config mode and allows you to configure VLAN settings.	Type <code>vlan</code> followed by a number (between 1 to 4094). For example, <code>vlan 10</code> to configure settings for VLAN 10.	sysname(config-vlan)#
Config-interface	This is a sub-mode of the config mode and allows you to configure port related settings.	Type <code>interface</code> <code>port-channel</code> followed by a port number. For example, <code>interface port-channel 10</code> to configure port 10 on the switch.	sysname(config-interface)#
Config-mvr	This is a sub-mode of the config mode and allows you to configure multicast VLAN settings.	To enter MVR mode, enter <code>mvr</code> followed by a VLAN ID (between 1 and 4094). For example, enter <code>mvr 2</code> to configure multicast settings on VLAN 2.	sysname(config-mvr)#

Enter `exit` to quit from the current mode or enter `logout` to exit the command interpreter.

## 34.8 Getting Help

The system includes a help facility to provide you with the following information about the commands:

- List of available commands under a command group.
- Detailed descriptions of the commands.

### 34.8.1 List of Available Commands

Enter “help” to display a list of available commands and the corresponding sub commands.

```
sysname> help
  Commands available:

  help
  logout
  exit
  history
  enable
  disable
  configure
  stk-port-test
  no logging
  no arp
  no interface <port-number>
  show slot
  show ip <cr>
  show ip route <cr>
  show ip route static
  show ip arp
  show ip tcp
  show ip udp
  show hardware-monitor <C|F>
  show system-information
  show vlanlq gvrp
  show vlanlq port-isolation
  show spanning-tree config
-- more --, next page: Space, continue: c, quit: ESC
```

Enter “?” to display a list of commands you can use.

```

sysname# ?
  baudrate           Change baud rate
  boot               Perform a cold start
  cable-diagnostics Execute cable diagnostics
  configure          Enter configuration mode
  copy               Backup/Restore system image and configuration
  disable            Turn off privileged commands
  enable             Turn on privileged commands
  erase              Reset system configuration
  exit               Exit from the EXEC
  help               Description of the interactive help system
  history            Show a list of previously run commands
  igmp-flush         Flush Igmp snooping table
  kick               Kick a session
  logout             Exit from the EXEC
  mac-flush          Flush MAC address table
  no                 Remove configuration
  ping               Exec ping
  reload             Perform a warm start
  show               Show system information
  ssh                SSH client
  traceroute         Exec traceroute
  write              Write running-config

```

Enter <command> help to display detailed sub commands and parameters.

```

sysname> ping help
  Commands available:

  ping <ip|host-name>
  <
    [ in-band|out-of-band|vlan <vlan-id> ]
    [ size <0-1472> ]
    [ -t ]
  >
sysname>

```

Enter <command> ? to display detailed help information about the sub commands and parameters.

```

sysname> ping ?
  <ip|host-name>      destination ip address
  help                Description of ping help
sysname>

```

## 34.9 Using Command History

The switch keeps a list of recently used commands available to you for reuse. You can use any commands in the history again by pressing the up (▲) or down (▼) arrow key to scroll through the previously used commands and press [ENTER]. Use the history command to display the list of commands.

```
sysname> history
  enable
  exit
  show ip
  history
sysname>
```

## 34.10 Saving Your Configuration

After you set the switch settings with the configuration commands, use the `write memory` command to save the changes permanently.

**Note:** The `write memory` command is not available in User mode.

You must save your changes after each CLI session. All unsaved configuration changes are lost once you restart the switch.

```
sysname# write memory
```

### 34.10.1 Switch Configuration File

When you configure the switch using either the CLI (Command Line Interface) or web configurator, the settings are saved as a series of commands in a configuration file on the switch. You can perform the following with a configuration file:

- Back up switch configuration once the switch is set up to work in your network.
- Restore switch configuration.
- Use the same configuration file to set all switches (of the same model) in your network to the same settings.

**Note:** You may also edit a configuration file using a text editor.

Make sure you use valid commands. The switch rejects configuration files with invalid or incomplete commands.

## 34.10.2 Logging Out

In User or Enable mode, enter the `exit` or `logout` command to log out of the CLI. In Config mode entering `exit` takes you out of the Config mode and into Enable mode and entering `logout` logs you out of the CLI.

## 34.11 Command Summary

The following sections summarize the commands available in the switch together with a brief description of each command. Commands listed in the tables are in the same order as they are displayed in the CLI. See the related section in the User's Guide for more background information.

### 34.11.1 User Mode

The following table describes the commands available for User mode.

**Table 84** Command Summary: User Mode

COMMAND		DESCRIPTION	PRIVILEGE
help		Displays help information.	0
logout		Exits from the CLI.	0
exit		Logs out from the CLI.	0
history		Displays a list of previously command(s) that you have executed. The switch stores up to 256 commands in history.	0
enable		Accesses Enable (or privileged) mode. See <a href="#">Section 34.11.2 on page 238</a> .	0
show	ip	Displays IP related information.	0
	hardware-monitor <C F>	Displays current hardware monitor information with the specified temperature unit (Celsius C or Fahrenheit F).	0
	system-information	Displays general system information.	0
ping	<IP host-name>	Sends Ping request to an Ethernet device.	0
	<IP host-name> [vlan <vlan-id>] [size <0-1472>] [-t]	Sends Ping request to an Ethernet device in the specified VLAN(s) with the specified parameters.	0
	help	Displays command help information.	0
traceroute	<ip host-name>	Determines the path a packet takes to a device.	0
	<ip host-name> [vlan <vlan-id>] [ttl <1-255>] [wait <1-60>] [queries <1-10>]	Determines the path a packet takes to a device in a VLAN.	0

**Table 84** Command Summary: User Mode (continued)

COMMAND		DESCRIPTION	PRIVILEGE
	help	Displays command help information.	0
ssh	<1 2> <[user@]dest-ip>	Connects to an SSH server with the specified SSH version.	0

### 34.11.2 Enable Mode

The following table describes the commands available for Enable mode.

**Table 85** Command Summary: Enable Mode

COMMAND		DESCRIPTION	PRIVILEGE	
help		Displays help information.	13	
logout		Exits Enable (or privileged) mode.	13	
exit		Exits Enable (or privileged) mode.	13	
history		Displays a list of command(s) that you have previously executed.	13	
enable		Accesses Enable (or privileged) mode.	13	
disable		Exits Enable (or privileged) mode.	13	
configure		Accesses Configuration mode. See <a href="#">Section 34.11.3 on page 243</a> .	13	
stk-port-test		Tests stack port list.	13	
no	logging	Clears system logs.	13	
	arp	Flushes the ARP (Address Resolution Protocol) table.	13	
	interface <port-number>	Clears the interface status of the specified port(s).	13	
show	ip	Displays IP related information.	13	
		arp	Displays the ARP table.	13
		tcp	Displays TCP related information.	13
		udp	Displays UDP related information.	13
		route	Displays IP routing information.	13
		route static	Displays IP static route information.	13
	hardware-monitor <C F>	Displays current hardware monitor information with the specified temperature unit (Celsius C or Fahrenheit F).	13	
	system-information	Displays general system information.	13	
	vlan1q	gvrp	Displays GVRP settings.	13

**Table 85** Command Summary: Enable Mode (continued)

COMMAND		DESCRIPTION	PRIVILEGE
	port-isolation	Displays port isolation settings.	13
spanning-tree	config	Displays Spanning Tree Protocol (STP) settings.	13
mrstp <treeIndex>		Displays the STP settings for the specific tree.	13
mac	address-table <all [mac vid port]>	Displays MAC address table. You can sort by MAC address, VID or port.	13
	address-table static	Displays static MAC address table.	13
	address-table count	Displays the number of static MAC address tables.	13
lacp		Displays LACP (Link Aggregation Control Protocol) settings.	13
trunk		Displays link aggregation information.	13
radius-server		Displays RADIUS server settings.	13
port-access- authenticator		Displays all port authentication settings.	13
	<port-list>	Displays port authentication settings on the specified port(s).	13
port-security		Displays all port security settings.	13
	<port-list>	Displays port security settings on the specified port(s).	13
snmp-server		Displays SNMP settings.	13
logins		Displays login account information.	13
service-control		Displays service control settings.	13
remote- management		Displays all secured client information.	13
	<index>	Displays the specified secured client information.	13
classifier		Displays all classifier related information.	13
	<name>	Displays the specified classifier related information.	13
policy		Displays all policy related information.	13
	<name>	Displays the specified policy related information.	13
	interface <port- list>	Displays current interface status.	13
	interfaces config <port- list>	Displays current interface configuration on the port(s).	13

**Table 85** Command Summary: Enable Mode (continued)

COMMAND		DESCRIPTION	PRIVILEGE
	bandwidth-control	Displays bandwidth control settings on the port(s).	13
	egress	Displays outgoing port information on the port(s).	13
	bstorm-control	Displays broadcast storm control settings on the port(s).	13
	igmp-immediate-leave	Displays IGMP immediate leave settings on the port(s).	13
	igmp-filtering	Displays IGMP filter profile settings on the port(s).	13
	igmp-group-limited	Displays IGMP group settings on the port(s).	13
	igmp-query-mode	Displays IGMP query mode settings on the port(s).	13
	protocol-based-vlan	Displays protocol based VLAN settings on the port(s).	13
	vlan	Displays the status of all VLANs.	13
	<vlan-id>	Displays the status of the specified VLAN.	13
	running-config	Displays current operating configuration.	13
	help	Displays detailed information and parameters for this command.	13
	interface port-channel <port-list> [bandwidth-limit...]	Displays current operating configuration on a port by port basis. Optionally specifies which settings are displayed.	13
	timesync	Displays time server information.	13
	time	Displays current system time and date.	13
	garp	Displays GARP information.	13
	loginPrecedence	Displays login precedence settings.	13
	logging	Displays system logs.	13
	vlan-stacking	Displays VLAN stacking configuration.	13
	ssh	Displays general SSH settings.	13
	known-hosts	Displays known SSH hosts information.	13
	key <rsa1 rsa dsa>	Displays internal SSH public and private key information.	13
	session	Displays current SSH session(s).	13
	https	Displays the HTTPS information.	13



**Table 85** Command Summary: Enable Mode (continued)

COMMAND		DESCRIPTION	PRIVILEGE	
		session	Displays current HTTPS session(s).	13
		certificate	Displays the HTTPS certificates.	13
		key <rsa dsa>	Displays the HTTPS key.	13
		timeout	Displays the HTTPS session timeout.	13
	multi-login		Displays multi-login information	13
	plt		Displays Packet Loop Test (PLT).	13
	mac-aging-time		Displays MAC learning aging time.	13
	cluster		Displays cluster management status.	13
		candidates	Displays cluster candidate information.	13
		member	Displays the MAC address of the cluster member(s).	13
		member mac <mac-addr>	Displays the status of the cluster member(s).	13
		members config	Displays the configuration of the cluster member(s).	13
	igmp-filtering profile		Displays IGMP filter profile settings.	13
	igmp-snooping		Displays IGMP snooping settings.	13
	multicast		Displays multicast settings.	13
	mvr		Displays all MVR (Multicast VLAN Registration) settings.	13
		<vlan-id>	Displays specified MVR information.	13
	diffserv		Displays DiffServ settings on the switch.	13
igmp-flush			Removes all IGMP information.	13
kick tcp	<Session ID>		Resets a TCP connection. Use the <code>show ip tcp</code> command to get the <b>Session ID</b> .	13
mac-flush			Clears the MAC address table.	13
	<port-num>		Removes all learned MAC address on the specified port(s).	13
erase	running-config		Resets to the factory default settings.	13
		interface port-channel <port-list> [bandwidth-limit...]	Resets to the factory default settings on a per port basis and optionally on a per feature configuration basis.	13

**Table 85** Command Summary: Enable Mode (continued)

COMMAND		DESCRIPTION	PRIVILEGE	
baudrate	<1 2 3 4 5>	Changes the console port speed. Choices are 1 (9600), 2 (19200), 3(38400), 4 (57600) and 5 (115200).	13	
boot	config <index>	Restarts the system with the specified configuration file.	13	
reload	config <index>	Restarts the system and use the specified configuration file.	13	
write	memory	Saves current configuration to the configuration file the switch is currently using.	13	
		<index>	Saves current configuration to the specified configuration file on the switch.	13
copy	tftp flash <ip> <remote-file>	Restores firmware via TFTP.	13	
	tftp config <index> <ip> <remote-file>	Restores configuration with the specified filename from the specified TFTP server.	13	
	running-config tftp <ip> <remote-file>	Backs up running configuration to the specified TFTP server with the specified file name.	13	
	running-config interface port- channel <port> <port-list>	Clones (copies) the attributes from the specified port to other ports.	13	
	running-config interface port- channel <port> <port-list>	[bandwidth- limit ....]	Copies the specified attributes from one port to other ports.	13
cable- diagnosti cs	<port-list>	Performs a basic connectivity test on the ports. Displays "Ok" if connector is inserted in the port, "Open" if no connector is inserted in the port or "Unknown" if this test cannot determine the status.	13	
ping	<ip host-name>	Sends Ping request to an Ethernet device.	13	
		[vlan <vlan- id>] [..]	Sends Ping request to an Ethernet device in the specified VLAN(s).	13
	help	Displays command help information.	13	
tracerout e	<ip host-name> [in-band out-of- band vlan <vlan- id>][ttl <1- 255>] [wait <1- 60>] [queries <1-10>]	Determines the path a packet takes to a device.	13	

**Table 85** Command Summary: Enable Mode (continued)

COMMAND		DESCRIPTION	PRIVILEGE	
	help		Displays command help information.	13
ssh	<1 2> <[user@]dest-ip>		Connects to an SSH server with the specified SSH version.	13
		[command </>]	Connects to an SSH server with the specified SSH version and addition commands to be executed on the server.	13

### 34.11.3 General Configuration Mode

The following table lists the commands in Configuration (or Config) mode.

**Table 86** Command Summary: Configuration Mode

COMMAND		DESCRIPTION	PRIVILEGE	
help			Displays help information.	13
logout			Exits from the CLI.	13
history			Displays a list of previous command(s) that you have executed.	13
exit			Exits from Config mode into Enable mode.	13
mode	zynos		Changes the CLI mode to the ZYNOS format.	13
password	<password>		Change the password for accessing Enable mode.	14
no	ip		Sets the management IP address to the default value.	13
		route <ip> <mask>	Removes a specified IP static route.	13
		route <ip> <mask> inactive	Enables a specified IP static route.	13
	igmp-filtering		Clears the IGMP filtering settings on the switch.	13
		profile <name>	Deletes the IGMP filtering profile.	13
		profile <name> start-address <ip> end- address <ip>	Deletes a rule in the IGMP filtering profile.	13
	igmp-snooping		Disables IGMP snooping.	13

**Table 86** Command Summary: Configuration Mode (continued)

COMMAND			DESCRIPTION	PRIVILEGE
	mac-forward	mac <mac-addr> vlan <vlan-id> interface <interface-id>	Removes the specified MAC forwarding entry, belonging to a VLAN group (if any) forwarded through an interface(s).	13
		mac <mac-addr> vlan <vlan-id> interface <interface-id> inactive	Enables the specified MAC address, belonging to a VLAN group (if any) forwarded through an interface(s).	13
	mac-filter	mac <mac-addr> vlan <vlan-id> inactive	Enables the specified MAC-filter rule.	13
		mac <mac-addr> vlan <vlan-id>	Disables the specified MAC filter rule.	13
	mirror-port		Disables port mirroring on the switch.	13
	lacp		Disables the link aggregation control protocol (dynamic trunking) on the switch.	13
	trunk	<T1 T2 T3 T4 T5 T6>	Disables the specified trunk group.	13
		<T1 T2 T3 T4 T5 T6> lacp	Disables LACP in the specified trunk group.	13
		<T1 T2 T3 T4 T5 T6> interface <port-list>	Removes ports from the specified trunk group.	13
	bcp-transparency		Disables Bridge Control Protocol (BCP) transparency.	13
	storm-control		Disables broadcast storm control.	13
	bandwidth-control		Disable bandwidth control on the switch.	13
	vlanlq	gvrp	Disables GVRP on the switch.	13
		port-isolation	Disables port isolation.	13
	spanning-tree		Disables STP.	13
		<port-list>	Disables STP on listed ports.	13
	mrstp	<treeIndex>	Disables the specified STP configuration (tree 1-6).	13
	mrstp	interface <port-list>	Disables the STP assignment from the specified port(s).	13
	timesync		Disables timeserver settings.	13
	radius-server	<index>	Disables the use of authentication from the specified RADIUS server.	13

**Table 86** Command Summary: Configuration Mode (continued)

COMMAND		DESCRIPTION	PRIVILEGE	
	port-access-authenticator		Disables port authentication on the switch.	13
		<port-list>	Disables authentication on the listed ports.	13
		<port-list> reauthenticate	Disables the re-authentication mechanism on the listed port(s).	13
	port-security		Disables port security on the switch.	13
		<port-list>	Disables port security on the specified ports.	13
		<port-list> learn inactive	Enables MAC address learning on the specified ports.	13
	snmp-server	trap-destination <ip>	Disables sending of SNMP traps to a station.	13
	logins	username <name>	Disables login access to the specified name.	14
	service-control	telnet	Disables telnet access to the switch.	13
		ftp	Disables FTP access to the switch.	13
		http	Disables web browser control to the switch.	13
		ssh	Disables SSH (Secure Shell) server access to the switch.	13
		https	Disables secure web browser access to the switch.	13
		icmp	Disables ICMP access to the switch such as pinging and tracerouting.	13
		snmp	Disables SNMP management.	13
	remote-management	<index>	Clears a secure client set entry from the list of secure clients.	13
		<index> service <[telnet] [ftp] [http] [icmp] [snmp] [ssh] [https]>	Disables a secure client set entry number from using the selected remote management service(s).	13
	classifier	<name>	Disables the classifier. Each classifier has one rule. If you disable a classifier you cannot use policy rule related information.	13
		<name> inactive	Enables a classifier.	13

**Table 86** Command Summary: Configuration Mode (continued)

COMMAND			DESCRIPTION	PRIVILEGE
	policy	<name>	Deletes the policy. A policy sets actions for classifier traffic.	13
		<name> inactive	Enables a policy.	13
	vlan	<vlan-id>	Deletes the static VLAN entry.	13
	dhcp-relay		Disables DHCP relay.	13
		option	Disables the relay agent information option 82.	13
		information	System name is not appended to option 82 information field.	13
	vlan-stacking		Disables VLAN stacking on the switch.	13
	ssh	key <rsa1 rsa dsa>	Disables the secure shell server encryption key. Your switch supports SSH versions 1 and 2 using RSA and DSA authentication.	13
		known-hosts	Removes all remote hosts.	13
		known-hosts <host-ip>	Removes the specified remote host from the list of all known hosts.	13
		known-hosts <host-ip> [1024 ssh- rsa ssh-dsa]	Removes remote known hosts with the specified public key (1024-bit RSA1, RSA or DSA).	13
	https	timeout	Resets the session timeout to the default of 300 seconds.	13
	multi-login		Disables another administrator from logging into Telnet.	14
	cluster		Disables cluster management on the switch.	13
	cluster member	<mac-address>	Removes the cluster member.	13
	mvr	<vlan-id>	Disables MVR on the switch.	13
	fe-spq		Disables Strict Priority Queuing on the switch.	13
	syslog		Disables syslog logging.	13
		server <ip- address>	Disables syslog logging to the specified syslog server.	13
		server <ip- address> inactive	Enables syslog logging to the specified syslog server.	13
		type [type]	Disables syslog logging for the specified log type (sys, link, config, error or report).	13

**Table 86** Command Summary: Configuration Mode (continued)

COMMAND		DESCRIPTION	PRIVILEGE	
vlan	<1-4094>	Enters the VLAN configuration mode. See <a href="#">Section 34.11.5 on page 259</a> for more information.	13	
vlan-type	<802.1q port-based>	Specifies the VLAN type.	13	
igmp-snooping		Enables IGMP snooping.	13	
	host-timeout	<1-16711450>	Sets the host timeout value.	13
	leave-timeout	<1-16711450>	Sets the leave timeout value	13
	unknown-multicast-frame <drop flooding>		Sets how to treat traffic from unknown multicast group.	13
	reserved-multicast-group <drop flooding>		Sets how to treat traffic belonging to reserved multicast groups.	13
	8021p-priority	<0-7>	Sets the 802.1p priority for outgoing igmp control packets.	13
igmp-filtering			Enables IGMP filtering on the switch.	13
	profile <name> start-address <ip> end-address <ip>		Sets the range of multicast address(es) in a profile.	13
interface	port-channel <port-list>		Enables a port or a list of ports for configuration. See <a href="#">Section 34.11.4 on page 255</a> for more details.	13
spq			Sets the queuing method to SPQ (Strictly Priority Queuing).	13
wfq			Sets the queuing method to WFQ (Weighted Fair Queuing).	13
wrr			Sets the queuing method to WRR (Weighted Round Robin).	13
fe-spq <q0 q1 ... q7>			Sets the switch to use SPQ to service the subsequent queue(s) after and including the specified queue for the 10/100 Mbps Ethernet ports.	13
ip	route	<ip> <mask> <next-hop-ip>	Creates a static route.	13
		<ip> <mask> <next-hop-ip> [metric <metric>] [name <name>] [inactive]	Sets the metric of a static route or deactivates a static route.	13

**Table 86** Command Summary: Configuration Mode (continued)

COMMAND			DESCRIPTION	PRIVILEGE
	name-server	<ip>	Sets the IP address of a domain name server.	13
	address default-gateway	<ip>	Sets the default gateway's IP address for the out-of-band management port.	13
	address	<ip> <mask>	Sets the IP address and subnet mask of the out-of-band management port.	13
mac-forward	name <name> mac <mac-addr> vlan <vlan-id> interface <interface-id>		Configures a static MAC address forwarding rule.	13
		inactive	Disables a static MAC address forwarding rule.	13
mac-filter	name <name> mac <mac-addr> vlan <vlan-id> drop <src/dst/both>		Configures a static MAC address port filtering rule.	13
		inactive	Disables a static MAC address port filtering rule.	13
mirror-port			Enables port mirroring.	13
	<port-num>		Sets the monitor port (the port to which traffic is copied for analysis).	13
lacp			Enables Link Aggregation Control Protocol (LACP).	13
	system-priority	<1-65535>	Sets the priority of an active port using LACP.	13
trunk	<T1 T2 T3 T4 T5 T6>		Activates a trunk group.	13
	<T1 T2 T3 T4 T5 T6> lacp		Enables LACP for a trunk group.	13
	<T1 T2 T3 T4 T5 T6> interface <port-list>		Adds a port(s) to the specified trunk group.	13
	interface <port-list> timeout <lacp-timeout>		Defines the port number and LACP timeout period.	13
cluster	<vlan-id>		Sets the cluster management VLAN ID.	13
	name <cluster name>		Configures a name to identify the cluster manager.	13



**Table 86** Command Summary: Configuration Mode (continued)

COMMAND		DESCRIPTION	PRIVILEGE
	member <mac-address> password <password-str>	Sets the cluster member switch's hardware MAC address and password.	13
	rcommand <mac-address>	Logs into a cluster member switch.	13
classifier	<name> <[ packet-format <802.3untag 802.3tag EtherIUntag EtherIItag>] [ priority <0-7> ] [ vlan <vlan-id> ] [ ethernet-type <ether-num ip ipx arp rarp appletalk decnet sna netbios dlc> ] [ source-mac <src-mac-addr> ] [ source-port <port-num> ] [ destination-mac <dest-mac-addr> ] [ dscp <0-63> ] [ ip-protocol <protocol-num tcp udp icmp egp ospf rsvp igmp igp pim ipsec> [establish-only] ] [ source-ip <src-ip-addr> [mask-bits <mask-bits>] ] [ source-socket <socket-num> ] [ destination-ip <dest-ip-addr> [mask-bits <mask-bits>] ] [ destination-socket <socket-num> ] [ inactive ] >	Configures a classifier. A classifier groups traffic into data flows according to specific criteria such as the source address, destination address, source port number, destination port number or incoming port number.	13

**Table 86** Command Summary: Configuration Mode (continued)

COMMAND		DESCRIPTION	PRIVILEGE
policy	<pre> &lt;name&gt; classifier &lt;classifier- list&gt; &lt; [ vlan&lt;vlan-id&gt; ] [ egress-port &lt;port-num&gt; ] [ priority &lt;0-7&gt; ] [ dscp &lt;0- 63&gt;] [ tos &lt;0-7&gt; ] [ bandwidth &lt;bandwidth&gt; ] [ outgoing- packet-format &lt;tagged untagged &gt; ] [ out- of-profile-dscp &lt;0-63&gt; ] [ forward-action &lt;drop forward&gt; ] [ queue-action &lt;prio-set prio- queue prio- replace-tos&gt; ] [ diffserv- action &lt;diff- set-tos diff- replace- priority diff- set-dscp&gt; ] [ outgoing- mirror ] [ outgoing-eport ] [ outgoing-non- unicast-eport ] [ outgoing-set- vlan ] [ metering] [ out-of- profile-action &lt;[ change-dscp ] [ drop ] [ forward ] [set-drop- prec]&gt; ] [ inactive ] &gt; </pre>	Configures a policy. A classifier distinguishes traffic into flows based on the configured criteria. A policy rule ensures that a traffic flow gets the requested treatment in the network.	13
radius-server	host <index> <ip>	Specifies the IP address of RADIUS server 1 or RADIUS server 2 (index =1 or index =2).	13
	[auth-port <socket-number>] [key <key-string>]	Sets the port number and key of the external RADIUS server.	13

**Table 86** Command Summary: Configuration Mode (continued)

COMMAND		DESCRIPTION	PRIVILEGE	
	timeout <1-1000>		Specifies the RADIUS server timeout value.	13
	mode	<priority round-robin>	Specifies the mode for RADIUS server selection.	13
port-access-authenticator			Enables 802.1x authentication on the switch.	13
	<port-list>		Enables 802.1x authentication on the specified port(s).	13
		reauthenticate	Sets a subscriber to periodically re-enter his or her username and password to stay connected to a specified port.	13
		reauth-period <reauth-period>	Specifies how often a client has to re-enter the username and password to stay connected to the specified port(s).	13
port-security			Enables port security on the switch.	13
	<port-list>		Enables the port security feature on the specified port(s).	13
		learn inactive	Disables MAC address learning on the specified port(s).	13
		address-limit <number>	Limits the number of (dynamic) MAC addresses that may be learned on a port.	13
		MAC-freeze	Disables MAC address learning and enables port security.  <b>Note:</b> All previously learned dynamic MAC addresses are saved to the static MAC address table.	13
vlanlq	gvrp		Enables GVRP.	13
	port-isolation		Enables port-isolation.	13
garp	join <100-65535> leave <msec> leaveall <msec>		Configures GARP time settings.	13
spanning-tree			Enables STP on the switch.	13
	priority <0-61440>		Sets the bridge priority of the switch.	13

**Table 86** Command Summary: Configuration Mode (continued)

COMMAND		DESCRIPTION	PRIVILEGE	
	hello-time <1-10> maximum-age <6-40> forward-delay <4-30>	Sets Hello Time, Maximum Age and Forward Delay.	13	
	<port-list>	Enables STP on a specified port.	13	
	<port-list> path-cost <1-65535>	Sets the STP path cost for a specified port.	13	
	<port-list> priority <0-255>	Sets the priority for a specified port.	13	
	help	Displays help information.	13	
mrstp	<treeIndex>	Activates the specified STP configuration.	13	
	interface <port-list>	Activates STP on the specified ports.	13	
		path-cost <1-65535>	Sets a path cost to the specified ports.	13
		priority <0-255>	Sets the priority value to the specified ports for STP.	13
		treeIndex <1-2>	Assigns a specific STP configuration to the ports.	13
	help	Displays the detailed help for the mrstp command.	13	
hostname	<name_string>	Sets the switch's name for identification purposes.	13	
time	<Hour:Min:Sec>	Sets the time in hour, minute and second format.	13	
	timezone <-1200 ... 1200>	Selects the time difference between UTC (formerly known as GMT) and your time zone.	13	
	date <month/day/year>	Sets the date in year, month and day format.	13	
	help	Displays help information.	13	
timesync	<daytime time ntp>	Sets the time server protocol.	13	
	server <ip>	Sets the IP address of your time server.	13	
loginPrecedence	<LocalOnly   LocalRADIUS   RADIUSOnly>	Select which database the switch should use (first) to authenticate a user.	14	
bcp-transparency		Enables Bridge Control Protocol (BCP) transparency.	13	
queue	priority <0-7> level <0-7>	Sets the priority level-to-physical queue mapping.	13	

**Table 86** Command Summary: Configuration Mode (continued)

COMMAND		DESCRIPTION	PRIVILEGE	
storm-control		Enables broadcast storm control on the switch.	13	
bandwidth-control		Enables bandwidth control.	13	
mac-aging-time	<10-3000>	Sets learned MAC aging time.	13	
snmp-server	get-community <property>	Sets the get community.	13	
	set-community <property>	Sets the set community.	13	
	trap-community <property>	Sets the trap community.	13	
	trap-destination <ip>	Sets the IP addresses of up to four stations to send your SNMP traps to.	13	
	[contact <system contact>] [location <system location>]	Sets the geographic location and the name of the person in charge of this switch.	13	
logins	username <name> password <pwd>	Configures a default (read-only) account.	14	
	username <name>	privilege <0-14>	Assigns a privilege level to user accounts.	14
service-control	icmp	Allows ICMP access for services such as Ping.	13	
	snmp	Allows SNMP management.	13	
	http <socket- number> <timeout>	Allows HTTP access on the specified service port and defines the timeout period.	13	
	telnet <socket- number>	Allows Telnet access on the specified service port.	13	
	ftp <socket- number>	Allows FTP access on the specified service port.	13	
	ssh <socket- number>	Allows SSH access on the specified service port.	13	
	https <socket- number>	Allows HTTPS access on the specified service port.	13	
remote-management	<index>	Enables a specified secured client set.	13	

**Table 86** Command Summary: Configuration Mode (continued)

COMMAND			DESCRIPTION	PRIVILEGE
	<index> start-addr <ip> end-addr <ip> service <[telnet] [ftp] [http] [icmp] [snmp] [ssh] [https]>		Specifies a group of trusted computer(s) from which an administrator may use a service to manage the switch.	13
admin-password	<pw-string> <confirm-string>		Changes the administrator password.	14
syslog			Enables syslog logging on the switch.	13
	server <ip-address>		Enables syslog logging to the specified syslog server.	13
	server <ip-address>	inactive	Disables syslog logging to the specified syslog server.	13
		level [0 ~ 7]	Sets the IP address of the syslog server and the severity level.	13
	type <type> facility [local 1 ..7]		Sets the log type and the file location on the syslog server.	13
vlan-stacking			Enables VLAN stacking on the switch.	13
	<SPTPID>		Sets the SP TPID (Service Provider Tag Protocol Identifier).	13
default-management	<in-band out-of-band>		Specifies through which traffic flow the switch is to send packets.	13
ssh	known-hosts <host-ip> <1024 ssh-rsa ssh-dsa> <key>		Adds a remote host to which the switch can access using SSH service.	13
https	cert-regeneration <rsa dsa>		Re-generates a certificate.	13
	timeout <0-65535>		Sets the HTTPS timeout period.	13
multi-login			Enables multi-login.	14
mvr <vlan-id>			Enters the MVR (Multicast VLAN Registration) configuration mode. See <a href="#">Section 34.11.6 on page 260</a> for more information.	13
dhcp-relay			Enables DHCP relay.	13
	helper-address <svr_ip> [svr2_ip] [svr3_ip]		Sets the IP addresses of up to 3 DHCP servers.	13

**Table 86** Command Summary: Configuration Mode (continued)

COMMAND		DESCRIPTION	PRIVILEGE	
	option		Allows the switch to add DHCP relay agent information.	13
	information		Allows the switch to add system name to agent information.	13
diffserv			Enables DiffServ on the switch.	13
	dscp <0-63>	priority <0-7>	Maps DSCP value with an 802.1p value.	13

### 34.11.4 interface port-channel Commands

The following table lists the `interface port-channel` commands in configuration mode. Use these commands to configure the ports.

**Table 87** interface port-channel Commands

COMMAND		DESCRIPTION	PRIVILEGE	
interface port- channel <port- list>			Enables a port or a list of ports for configuration.	13
	weight <wt1> <wt2> ... <wt8>		Sets the interface to use WFQ weighting. A weight value of one to eight is given to each variable from wt 1 to wt 8.	13
	ge-spq	<q0 q1 ... q7>	Enables strict priority queuing starting with the specified queue and subsequent higher queues on the Gigabit ports.	13
	egress set <port-list>		Sets the outgoing traffic port list for a port-based VLAN.	13
	igmp-immediate- leave		Enables IGMP immediate leave on the port.	13
	igmp-filtering profile <name>		Sets the IGMP filtering profile for this port.	13
	igmp-group- limited		Limits the number of multicast groups.	13
	igmp-group- limited number <number>		Sets the number of multicast groups this port is allowed to join.	13

**Table 87** interface port-channel Commands (continued)

COMMAND		DESCRIPTION	PRIVILEGE	
	igmp-querier-mode <auto fixed edge>	Sets the IGMP querier mode of a port. Selects <i>auto</i> to treat the IGMP queries normally, <i>fixed</i> to always treat the port as a querier port no matter there is a query or <i>edge</i> to treat the port as a non-querier port which drops any IGMP queries received.	13	
	pvid <1-4094>	The default PVID is VLAN 1 for all ports. Sets a PVID in the range 1 to 4094 for the specified interface.	13	
	ingress-check	Enables the device to discard incoming frames for VLANs that are not included in a port member set.	13	
	gvrp	Enables this function to permit VLAN groups beyond the local switch.	13	
	frame-type <all tagged untagged>	Choose to accept both tagged and untagged incoming frames, just tagged incoming frames or just untagged incoming frames on a port.	13	
	name <port-name-string>	Sets a name for the port(s). Enter a descriptive name (up to nine printable ASCII characters).	13	
	vlan-trunking	Enables VLAN Trunking on ports connected to other switches or routers (but not ports directly connected to end users) to allow frames belonging to unknown VLAN groups to pass through the switch.	13	
	flow-control	Enables interface flow control. Flow control regulates transmissions to match the bandwidth of the receiving port.	13	
	bandwidth-limit	Enables ingress (pir), cir and egress limits on the port(s).	13	
		cir	Enables the guaranteed bandwidth limits for incoming traffic on the port(s).	13
		cir <Kbps>	Sets the guaranteed bandwidth allowed for incoming traffic on the port(s).	13
		pir	Enables bandwidth limits allowed for incoming traffic on the port(s).	13
		pir <Kbps>	Sets the maximum bandwidth allowed for incoming traffic on the port(s).	13



**Table 87** interface port-channel Commands (continued)

COMMAND		DESCRIPTION	PRIVILEGE	
	egress	Enables bandwidth limits allowed for outgoing traffic on the port(s).	13	
	egress <Kbps>	Sets the maximum bandwidth allowed for outgoing traffic on the port(s).	13	
	broadcast-limit	Enables broadcast storm control limit on the switch.	13	
	<pkt/s>	Sets how many broadcast packets the interface receives per second.	13	
	multicast-limit	Enables the interface multicast limit.	13	
	<pkt/s>	Sets how many multicast packets the interface receives per second.	13	
	dlf-limit	Enables the Destination Lookup Failure (DLF) limit.	13	
	<pkt/s>	Sets the interface DLF limit in packets per second (pps).	13	
	diffserv	Enables DiffServ on the port(s).	13	
	qos priority	<0 .. 7>	Sets the quality of service priority for an interface.	13
	mirror	Enables port mirroring in the interface.	13	
	dir <ingress egress  both>	Enables port mirroring for incoming, outgoing or both incoming and outgoing traffic. Port mirroring copies traffic from one or all ports to another or all ports for external analysis.	13	
	speed-duplex	<auto 10-half 10-full 100-half 100-full 1000-full>	Sets the duplex mode (half or full) and speed (10, 100 or 1000 Mbps) of the connection on the interface. Selecting auto (auto-negotiation) makes one port able to negotiate with a peer automatically to obtain the connection speed and duplex mode that both ends support.	13
	bpdu-control <peer tunnel discard network>	Sets how Bridge Protocol Data Units (BPDUs) are used in STP port states.	13	
	no	egress set <port-list>	Disables the outgoing traffic port list for a port-based VLAN.	13
		protocol-based-vlan ethernet-type <ethernet-type>	Disables protocol based VLAN of the specified protocol on the port.	13
		igmp-immediate-leave	Disables IGMP immediate leave on the port.	13

**Table 87** interface port-channel Commands (continued)

COMMAND		DESCRIPTION	PRIVILEGE
		igmp-filtering profile	Disables IGMP filtering on the port. 13
		igmp-group- limited	Disables IGMP group limitation. 13
		ingress-check	Disables ingress checking on the port(s). 13
		gvrp	Disable GVRP on the port(s). 13
		flow-control	Disables flow control on the port(s). 13
		vlan-trunking	Disables VLAN trunking on the port(s). 13
		mirror	Disables port mirroring on the port(s). 13
		bandwidth-limit	Disables bandwidth limit on the port(s). 13
		broadcast-limit	Disables broadcast storm control limit on the switch. 13
		multicast-limit	Disables multicast limit on the switch. 13
		dlf-limit	Disables destination lookup failure (DLF) limit on the switch. 13
		inactive	Enables the port(s) on the switch. 13
		intrusion-lock	Disables intrusion-lock on a port so that a port can be connected again after you disconnected the cable. 13
		ge-spq <q0 q1 ... q7>	Disables strict priority queuing on the Gigabit ports. 13
	inactive		Disables the specified port(s) on the switch. 13
	help		Displays a description of the interface port-channel commands. 13
	vlan-stacking role <normal access  tunnel>		Sets the VLAN stacking port roles of the specified interface. 13
	vlan-stacking SPVID <1-4094>		Sets the service provider VID of the specified interface. 13
	vlan-stacking priority <0-7>		Sets the priority of the specified interface in VLAN stacking. 13
	exit		Exits from the interface port-channel command mode. 13
	intrusion-lock		Enables intrusion lock on a port and a port cannot be connected again after you disconnected the cable. 13
	test		Performs an interface loopback test. 13

**Table 87** interface port-channel Commands (continued)

COMMAND		DESCRIPTION	PRIVILEGE	
	protocol-based-vlan name <name> ethernet-type <ethernet-type> vlan <vid> priority <0-7>		Creates a protocol based VLAN with the specified parameters.	13
		inactive	Disables the protocol based VLAN.	13

### 34.11.5 config-vlan Commands

The following table lists the `vlan` commands in configuration mode.

**Table 88** Command Summary: config-vlan Commands

COMMAND		DESCRIPTION	PRIVILEGE	
vlan <1-4094>			Creates a new VLAN group.	13
	name <name-str>		Specifies a name for identification purposes.	13
	normal <port-list>		Specifies the port(s) to dynamically join this VLAN group using GVRP	13
	fixed <port-list>		Specifies the port(s) to be a permanent member of this VLAN group.	13
	forbidden <port-list>		Specifies the port(s) you want to prohibit from joining this VLAN group.	13
	untagged <port-list>		Specifies the port(s) you don't want to tag all outgoing frames transmitted with this VLAN Group ID.	13
	inactive		Disables the specified VLAN.	13
	help		Displays a list of available VLAN commands.	13
	no	fixed <port-list>	Sets fixed port(s) to normal port(s).	13
		forbidden <port-list>	Sets forbidden port(s) to normal port(s).	13
		untagged <port-list>	Enables VLAN tagging for outgoing traffic on the specified port(s).	13
		inactive	Enables the specified VLAN.	13

**Table 88** Command Summary: config-vlan Commands (continued)

COMMAND		DESCRIPTION	PRIVILEGE
		ip address inband-default dhcp-bootp	13 Sets the default in-band interface to use a static IP address in this VLAN. The switch will use the default IP address of 0.0.0.0 if you do not configure a static IP address.
		ip address <ip-address> <mask>	13 Deletes the IP address and subnet mask from this VLAN.
		ip address default-gateway	13 Deletes the default gateway from this VLAN.
	exit		13 Leaves the VLAN configuration mode.
	ip address	inband-default dhcp-bootp	13 Sets the dynamic in-band IP address.
		inband-default dhcp-bootp release	13 Releases the dynamic in-band IP address.
		inband-default dhcp-bootp renew	13 Updates the dynamic in-band IP address.
		inband-default <ip-address> <mask>	13 Sets a static in-band IP address and subnet mask.
		<ip-address> <mask> manageable	13 Sets the management IP address and subnet mask of the switch in the specified VLAN.
		<ip-address> <mask>	13 Sets the IP address and subnet mask of the switch in the specified VLAN.
		default-gateway <ip-address>	13 Sets a default gateway IP address for this VLAN.

### 34.11.6 mvr Commands

The following table lists the `mvr` commands in configuration mode.

**Table 89** mvr Commands

COMMAND		DESCRIPTION	PRIVILEGE
mvr <1-4094>			13 Enters the MVR (Multicast VLAN Registration) configuration mode.
	source-port <port-list>		13 Sets the source port(s). An MVR source port can send and receive multicast traffic in a multicast VLAN.

**Table 89** mvr Commands (continued)

COMMAND		DESCRIPTION	PRIVILEGE
	receiver-port <port-list>	Sets the receiver port(s). An MVR receiver port can only receive multicast traffic in a multicast VLAN.	13
	inactive	Disables MVR settings.	13
	mode <dynamic compatible>	Sets the MVR mode (dynamic or compatible).	13
	name <name-str>	Sets the MVR name for identification purposes.	13
	tagged <port-list>	Sets the port(s) to tag VLAN tags.	13
	group <name-str> start-address <ip> end-address <ip>	Sets the multicast group range for the MVR.	13
	exit	Exist from the MVR configuration mode.	13
	8021p-priority <0-7>	Sets a priority level (0-7) to which the switch changes the priority in outgoing IGMP control packets.	13
	no source-port <port-list>	Disables the source port(s). An MVR source port can send and receive multicast traffic in a multicast VLAN.	13
	no receiver-port <port-list>	Disables the receiver port(s). An MVR receiver port can only receive multicast traffic in a multicast VLAN.	13
	no tagged <port-list>	Sets the port(s) to untag VLAN tags.	13
	no inactive	Enables MVR.	13
	no group	Disables all MVR group settings.	13
	no group <name-str>	Disables the specified MVR group setting.	13



# CHAPTER 35

## User and Enable Mode Commands

This chapter describes some commands which you can perform in the User and Enable modes.

### 35.1 Overview

The following command examples show how you can use User and Enable modes to diagnose and manage your switch.

### 35.2 show Commands

These are the commonly used `show` commands.

#### 35.2.1 show system-information

Syntax:

```
show system-information
```

This command shows the general system information (such as the firmware version and system up time).

An example is shown next.

```
sysname# show system-info
System Name           : ES-3148
System Contact       :
System Location      :
Ethernet Address     : 00:13:49:00:00:02
ZyNOS F/W Version    : V3.70(TZ.0)b0 | 7/10/2006
RomRasSize           : 2467172
System up Time       : 0:47:03 (44ef3 ticks)
Bootbase Version     : V0.6 | 07/05/2005
ZyNOS CODE           : RAS Jul 10 2006 08:40:31
Product Model        : ES-3148
```

## 35.2.2 show ip

Syntax:

```
show ip
```

This command displays the IP related information (such as IP address and subnet mask) on all switch interfaces.

The following figure shows the default interface settings.

```
sysname> show ip
Out-of-band Management IP Address = 192.168.0.1
Management IP Address
    IP[192.168.0.1], Netmask[255.255.255.0], VID[0]
IP Interface
    IP[192.168.1.1], Netmask[255.255.255.0], VID[1]
sysname>
```

## 35.2.3 show logging

Syntax:

```
show logging
```

This command displays the system logs. The following figure shows an example.

```
sysname# show logging
 1 Thu Jan 1 00:02:08 1970 PP05 -WARN  SNMP TRAP 3: link up
 2 Thu Jan 1 00:03:14 1970      INFO  adjtime task pause 1 day
 3 Thu Jan 1 00:03:16 1970 PP0f -WARN  SNMP TRAP 26: Event On Trap
 4 Thu Jan 1 00:03:16 1970 PINI -WARN  SNMP TRAP 1: warm start
 5 Thu Jan 1 00:03:16 1970 PINI -WARN  SNMP TRAP 3: link up
 6 Thu Jan 1 00:03:16 1970 PINI  INFO  main: init completed
 7 Thu Jan 1 00:00:13 1970 PP26  INFO  adjtime task pause 1 day
 8 Thu Jan 1 00:00:14 1970 PP0f -WARN  SNMP TRAP 26: Event On Trap
 9 Thu Jan 1 00:00:14 1970 PINI -WARN  SNMP TRAP 0: cold start
10 Thu Jan 1 00:00:14 1970 PINI  INFO  main: init completed
11 Thu Jan 1 00:00:04 1970 PP05 -WARN  SNMP TRAP 3: link up
11 Thu Jan 1 00:00:04 1970 PP05 -WARN  SNMP TRAP 3: link up
Clear Error Log (y/n):
```

**Note:** If you clear a log (by entering *y* at the Clear Error Log (y/n) :prompt), you cannot view it again.

## 35.2.4 show interface

Syntax:

```
show interface [port-number]
```



This command displays statistics of a port. The following example shows that port 2 is up and the related information.

```

sysname# show interface 2
  Port Info      Port NO.      :2
                Link          :100M/F
                Status       :FORWARDING
                LACP         :Disabled
                TxPkts       :0
                RxPkts       :63
                Errors       :0
                Tx KBs/s     :0.0
                Rx KBs/s     :0.0
                Up Time      :0:02:33
TX Packet      Tx Packets    :0
                Multicast    :0
                Broadcast    :0
                Pause        :0
                Tagged       :0
RX Packet      Rx Packets    :63
                Multicast    :0
                Broadcast    :63
                Pause        :0
                Control      :0
TX Collison    Single         :0
                Multiple    :0
                Excessive   :0
                Late        :0
Error Packet   RX CRC        :0
                Length      :0
                Runt        :0
Distribution   64          :3
                65 to 127   :44
                128 to 255  :14
                256 to 511   :2
                512 to 1023  :0
                1024 to 1518 :0
                Giant       :0
sysname#

```

### 35.2.5 show mac address-table

Syntax:

```
show mac address-table <all <sort>|static>
```

Where

<sort> = Specifies the sorting criteria (MAC, VID or port).

This command displays the MAC address(es) stored in the switch. The following example shows the static MAC address table.

```
sysname# show mac address-table static
Port      VLAN ID      MAC Address      Type
CPU       1            00:a0:c5:01:23:46  Static
sysname#
```

## 35.3 ping

Syntax:

```
ping <ip|host-name> < [in-band|out-of-band|vlan <vlan-id> ] [
size <0-1472> ] [ -t ]>
```

where

<ip|host-name> = The IP address or host name of an Ethernet device.

[in-band|out-of-band|vlan <vlan-id> ] = Specifies the network interface or the VLAN ID to which the Ethernet device belongs. out-of-band refers to the management port while in-band means the other ports on the switch.

[ size <0-1472> ] = Specifies the packet size to send.

[ -t ] = Sends Ping packets to the Ethernet device indefinitely. Press [CTRL]+ C to terminate the Ping process.

This command sends Ping packets to an Ethernet device. The following example sends Ping requests to and displays the replies from an Ethernet device with an IP address of 192.168.1.100.

```
sysname# ping 192.168.1.100
sent  rcvd  rate    rtt     avg     mdev     max     min  reply from
  1     1    100      0       0       0       0       0  192.168.1.100
  2     2    100      0       0       0       0       0  192.168.1.100
  3     3    100      0       0       0       0       0  192.168.1.100
sysname#
```

## 35.4 traceroute

Syntax:

```
traceroute <ip|host-name> [in-band|out-of-band|vlan <vlan-
id>][ttl <1-255>] [wait <1-60>] [queries <1-10>]
```

where

<ip host-name>	=	The IP address or host name of an Ethernet device.
[in-band out-of-band vlan <vlan-id> ]	=	Specifies the network interface or the VLAN ID to which the Ethernet device belongs.
[ttl <1-255>]	=	Specifies the Time To Live (TTL) period.
[wait <1-60>]	=	Specifies the time period to wait.
[queries <1-10>]	=	Specifies how many tries the switch performs the traceroute function.

This command displays information about the route to an Ethernet device. The following example displays route information to an Ethernet device with an IP address of 192.168.1.100.

```
sysname> traceroute 192.168.1.100
traceroute to 192.168.1.100, 30 hops max, 40 byte packet
 1:192.168.1.100 (10 ms) (10 ms) (0 ms)
traceroute done:
sysname>
```

## 35.5 Copy Port Attributes

Use the `copy running-config` command to copy attributes of one port to another port or ports.

Syntax:

```
copy running-config interface port-channel <port> <port-list>

copy running-config interface port-channel <port> <port-list>
[active] [name] [speed-duplex] [bpdu-control] [flow-control]
[intrusion-lock] [vlanlq] [vlanlq-member] [bandwidth-limit]
[vlan-stacking] [port-security] [broadcast-storm-control]
[mirroring] [port-access-authenticator] [queuing-method] [igmp-
filtering] [spanning-tree] [mrstp] [protocol-based-vlan] [port-
based-vlan]
```

where

```
copy running-config = Copies all of the possible attributes from one port to another port
interface port-      or ports.
channel <port>
<port-list>
copy running-config = Copies only the specified port attributes from one port to another
interface port-      port or ports.
channel <port>
<port-list> [active
... ]
```

An example is shown next.

- Copy all attributes of port 1 to port 2
- Copy selected attributes (active, bandwidth limit and STP settings) to ports 5-8

```
sysname# copy running-config interface port-channel 1 2
sysname# copy running-config interface port-channel 1 5-8 active
bandwidth-limit spanning-tree
```

## 35.6 Configuration File Maintenance

The following sections shows how to manage the configuration files.

### 35.6.1 Using a Different Configuration File

You can store up to two configuration files on the switch. Only one configuration file is used at a time. By default the switch uses the first configuration file (with an index number of 1). You can set the switch to use a different configuration file. There are two ways in which you can set the switch to use a different configuration file: restart the switch (cold reboot) and restart the system (warm reboot).

Use the `boot config` command to restart the switch and use a different configuration file (if specified). The following example restarts the switch to use the second configuration file.

```
sysname# boot config 2
```

Use the `reload config` command to restart the system and use a different configuration file (if specified). The following example restarts the system to use the second configuration file.

```
sysname# reload config 2
```

**Note:** When you use the `write memory` command without specifying a configuration file index number, the switch saves the changes to the configuration file the switch is currently using.

## 35.6.2 Resetting to the Factory Default

Follow the steps below to reset the switch back to the factory defaults.

- 1 Enter `erase running-config` to reset the current running configuration.
- 2 Enter `write memory` to save the changes to the current configuration file. If you want to reset the second configuration file, use the `write memory` command again with the specified index number.

The following example resets both configuration files to the factory default settings.

```
sysname# erase running-config
sysname# write memory
sysname# write memory 2
```



# CHAPTER 36

## Configuration Mode Commands

This chapter describes how to enable and configure your switch's features using commands. For more background information, see the feature specific chapters which proceed the commands chapters.

### 36.1 Enabling IGMP Snooping

To enable IGMP snooping on the switch. Enter `igmp-snooping` and press [ENTER]. You can also set how to treat traffic from an unknown multicast group by typing the `unknown-multicast-frame` parameter.

Syntax:

```
igmp-snooping
igmp-snooping host-timeout <1-16711450>
igmp-snooping leave-timeout <1-16711450>
igmp-snooping unknown-multicast-frame <drop|flooding>
igmp-snooping reserved-multicast-group <drop|flooding>
```

where

<code>igmp-snooping</code>	=	Enables IGMP snooping on the switch.
<code>host-timeout &lt;1-16711450&gt;</code>	=	Specifies the time out period of the switch with respect to IGMP report queries. If an IGMP report for a multicast group was not received for a host-timeout period, from a specific port, this port is deleted from the member list of that multicast group.
<code>leave-timeout &lt;1-16711450&gt;</code>	=	Specifies the time that the switch will wait for multicast members to respond to a leave report. If no response happens in the timeout period, the switch deletes the port from the multicast group.
<code>unknown-multicast-frame &lt;drop flooding&gt;</code>	=	Specifies whether you want to discard packets from unknown multicast groups or whether you want to forward them to all ports.
<code>reserved-multicast-group &lt;drop flooding&gt;</code>	=	Specifies whether you want to discard packets in the reserved multicast groups or whether you want to forward them to all ports.

An example is shown next.

- Enable IGMP snooping on the switch.
- Set the `host-timeout` and `leave-timeout` values to 30 seconds
- Set the switch to drop packets from unknown multicast groups.

```
sysname(config)# igmp-snooping
sysname(config)# igmp-snooping host-timeout 30
sysname(config)# igmp-snooping leave-timeout 30
sysname(config)# igmp-snooping unknown-multicast-frame drop
```

## 36.2 Configure IGMP Filter

Use the following commands in the config mode to configure IGMP filtering profiles.

Syntax:

```
igmp-filtering
igmp-filtering profile <name> start-address <ip> end-address
<ip>
```

where

- `igmp filtering` = Enables IGMP filtering on the switch
- `profile <name>` = Specifies a name (up to 32 alphanumeric characters) for this IGMP profile. If you want to edit an existing IGMP profile enter the existing profile name followed by `start-address` and `end-address` parameters.
- `start-address` = Specifies the starting multicast IP address for a range of multicast IP addresses that you want to belong to the IGMP filter profile. IP address in the range 224.0.0.0 to 239.255.255.255 are used for IP multicasting.
- `end-address` = Specifies the ending multicast IP address for a range of multicast IP addresses that you want to belong to the IGMP filter profile. IP address in the range 224.0.0.0 to 239.255.255.255 are used for IP multicasting.

An example is shown next.

- Enable IGMP filtering on the switch.
- Create an IGMP filtering profile **filter1** and specify the multicast IP addresses in the range **224.255.255.0** to **225.255.255.255** to belong to this profile.

```
sysname(config)# igmp-filtering
sysname(config)# igmp-filtering profile filter1 start-address
224.255.255.0 end-address 225.255.255.255
```



## 36.3 Enabling STP

Use the `spanning-tree` or the `mrstp` commands to enable and configure STP on the switch. The difference between the commands is that `spanning-tree` only allows you to set up one spanning tree configuration and the `mrstp` command allows you to set up multiple ones.

Syntax:

```
spanning-tree
spanning-tree priority <0-61440>
spanning-tree hello-time <1-10> maximum-age <6-40> forward-
delay <4-30>
spanning-tree <port-list> path-cost <1-65535>
spanning-tree <port-list> priority <0-255>
```

and

```
mrstp <treeIndex> <cr>
mrstp <treeIndex> priority <0-61440>
mrstp <treeIndex> hello-time <1-10> maximum-age <6-40> forward-
delay <4-30>
mrstp interface <port-list> <cr>
mrstp interface <port-list> path-cost <1-65535>
mrstp interface <port-list> priority <0-255>
mrstp interface <port-list> treeIndex <1-2>
```

where

<code>spanning-tree</code>	=	Enables STP on the switch.
<code>mrstp &lt;treeIndex&gt;</code>		Enables a specific tree configuration.
<code>priority &lt;0-61440&gt;</code>	=	Specifies the bridge priority for the switch. The lower the numeric value you assign, the higher the priority for this bridge.

Bridge priority is used in determining the root switch, root port and designated port. The switch with the highest priority (lowest numeric value) becomes the STP root switch. If all switches have the same priority, the switch with the lowest MAC address will then become the root switch.

Bridge Priority determines the root bridge, which in turn determines Hello Time, Max Age and Forwarding Delay.

<code>hello-time &lt;1-10&gt;</code>	=	Specifies the time interval in seconds between BPDU (Bridge Protocol Data Units) configuration message generations by the root switch.
--------------------------------------	---	--

- `maximum-age <6-40>` = Specifies the maximum time (in seconds) a switch can wait without receiving a BPDU before attempting to reconfigure. All switch ports (except for designated ports) should receive BPDUs at regular intervals. Any port that ages out STP information (provided in the last BPDU) becomes the designated port for the attached LAN. If it is a root port, a new root port is selected from among the switch ports attached to the network.
- `forward-delay <4-30>` = Specifies the maximum time (in seconds) a switch will wait before changing states. This delay is required because every switch must receive information about topology changes before it starts to forward frames. In addition, each port needs time to listen for conflicting information that would make it return to a blocking state; otherwise, temporary data loops might result.
- `<port-list> path-cost <1-65535>` = Enables STP on the specified ports.  
Specifies the cost of transmitting a frame on to a LAN through that port. It is assigned according to the speed of the bridge.
- `<port-list> priority <0-255>` = Specifies the priority for each port.  
Priority decides which port should be disabled when more than one port forms a loop in a switch. Ports with a higher priority numeric value are disabled first.
- `<port-list> treeIndex <1-2>` = Specifies which STP configuration these ports will participate in. (`mrstp` command only).

An example using `spanning-tree` command is shown next.

- Enable STP on the switch.
- Set the bridge priority of the switch to 0.
- Set the Hello Time to 4, Maximum Age to 20 and Forward Delay to 15 on the switch.
- Enable STP on port 5 with a path cost of 150.
- Set the priority for port 5 to 20.

```
sysname(config)# spanning-tree priority 0
sysname(config)# spanning-tree hello-time 4 maximum-age 20
-> forward-delay 15
sysname(config)# spanning-tree 5 path-cost 150
sysname(config)# spanning-tree 5 priority 20
```

## 36.4 no Command Examples

These are the commonly used command examples that belong to the `no` group of commands. The `no` group commands are commands which are preceded by keyword `no`. This command negates the intended action of the command. In most cases the `no` command disables, resets or clears settings. There are cases, however, where the `no` command can activate features. This section shows some uses of these commands.

### 36.4.1 Disable Commands

Use the `no` command to disable features on the switch.

Syntax:

```
no spanning-tree
no mirror-port
```

Disables STP on the switch.

Disables port mirroring on the switch.

### 36.4.2 Resetting Commands

Use the `no` command to reset switch settings to their default values.

Syntax:

```
no https timeout
```

Resets the https session timeout to default.

An example is shown next. The session timeout is reset to 300 seconds.

```
sysname(config)# no https timeout
Cache timeout 300
```

### 36.4.3 Re-enable commands

The `no` command can also be used to re-enable features which have been disabled.

Syntax:

```
no ip route <ip> <mask> inactive
```

where

<ip> <mask> inactive = Re-enables an ip route with the specified IP address and subnet mask.

An example is shown next.

- Enable the IP route with the IP address of 192.168.11.1 and subnet mask of 255.255.255.0. This ip route must have already been created and made inactive prior to re-enable command being applied.

```
sysname(config)# no ip route 192.168.11.1 255.255.255.0 inactive
```

### 36.4.4 Other Examples of no Commands

In some cases the `no` command can disable a feature, disable an option of a feature or disable a feature on a port by port basis.

#### 36.4.4.1 no trunk

Syntax:

```
no trunk <T1|T2|T3|T4|T5|T6>
no trunk <T1|T2|T3|T4|T5|T6> lacp
no trunk <T1|T2|T3|T4|T5|T6> interface <port-list>
```

where

<T1|T2|T3|T4|T5|T6> = Disables the trunk group.  
<T1|T2|T3|T4|T5|T6> lacp = Disables LACP in the trunk group.  
<T1|T2|T3|T4|T5|T6> interface <port-list> = Removes ports from the trunk group.

An example is shown next.

- Disable trunk one (T1).
- Disable LACP on trunk three (T3).
- Remove ports one, three, four and five from trunk two (T2).

```
sysname(config)# no trunk T1
sysname(config)# no trunk T3 lacp
sysname(config)# no trunk T2 interface 1,3-5
```

### 36.4.4.2 no port-access-authenticator

Syntax:

```
no port-access-authenticator
no port-access-authenticator <port-list> reauthenticate
no port-access-authenticator <port-list>
```

where

	=	Disables port authentication on the switch.
<port-list> reauthenticate	=	Disables the re-authentication mechanism on the listed port(s).
<port-list>	=	Disables authentication on the listed ports.

An example is shown next.

- Disable authentication on the switch.
- Disable re-authentication on ports one, three, four and five.
- Disable authentication on ports one, six and seven.

**Figure 116** no port-access-authenticator Command Example

```
sysname(config)# no port-access-authenticator
sysname(config)# no port-access-authenticator 1,3-5 reauthenticate
sysname(config)# no port-access-authenticator 1,6-7
```

### 36.4.4.3 no ssh

Syntax:

```
no ssh key <rsa1|rsa|dsa>
no ssh known-hosts <host-ip>
no ssh known-hosts <host-ip> [1024|ssh-rsa|ssh-dsa]
```

where

key <rsa1 rsa dsa>	=	Disables the secure shell server encryption key. Your switch supports SSH versions 1 and 2 using RSA and DSA authentication.
known-hosts <host-ip>	=	Removes a specific remote host from the list of all known hosts.
known-hosts <host-ip> [1024 ssh-rsa ssh-dsa]	=	Removes remote known hosts with a specified public key type (1024-bit RSA1, RSA or DSA).

An example is shown next.

- Disable the secure shell RSA1 encryption key.
- Remove the remote host with IP address 172.165.1.8 from the list of known hosts.
- Remove the remote host with IP address 172.165.1.9 and with an SSH-RSA encryption key from the list of known hosts.

```
sysname(config)# no ssh key rsa1
sysname(config)# no ssh known-hosts 172.165.1.8
sysname(config)# no ssh known-hosts 172.165.1.9 ssh-rsa
```

## 36.5 Queuing Method Commands

You can use the queuing method commands to configure queuing for outgoing traffic on the switch. You can only select one queuing method for the switch.

Syntax:

```
spq
wfq
wrr
wrr fe-spq <Q0-Q7>
```

where

<code>spq</code>	=	Sets the queuing method to SPQ (Strictly Priority Queuing).
<code>wfq</code>	=	Sets the queuing method to WFQ (Weighted Fair Queuing).
<code>wrr</code>	=	Sets the queuing method to WRR (Weighted Round Robin).
<code>wrr fe-spq &lt;Q0-Q7&gt;</code>	=	Sets the switch to use SPQ to service the subsequent queue(s) after and including the specified queue.

You may want to configure weights for specific queues on the ports if you use WRR. See the weight command example in [Section 37.2.9 on page 289](#).

An example is shown next.

- Set the queuing method to SPQ.

```
sysname(config)# spq
```

## 36.6 Static Route Commands

You can create and configure static routes on the switch by using the `ip route` command.

**Syntax:**

```
ip route <ip> <mask> <next-hop-ip>
ip route <ip> <mask> <next-hop-ip> [metric <metric>] [name
<name>] [inactive]
```

**where**

<ip>	=	Specifies the network IP address of the final destination.
<mask>	=	Specifies the subnet mask of this destination.
<next-hop-ip>	=	Specifies the IP address of the gateway. The gateway is an immediate neighbor of your switch that will forward the packet to the destination. The gateway must be a router on the same segment as your switch.
[metric <metric>]	=	The metric represents the “cost” of transmission for routing purposes. IP routing uses hop count as the measurement of cost, with a minimum of 1 for directly connected networks. Enter a number that approximates the cost for this link. The number need not be precise, but it must be between 1 and 15. In practice, 2 or 3 is usually a good number.
[name <name>]	=	Specifies a descriptive name (up to 32 printable ASCII characters) for identification purposes.
[inactive]	=	Deactivates a static route

An example is shown next.

- Create a static route with the destination IP address of 172.21.1.104, subnet mask of 255.255.0.0 and the gateway IP address of 192.168.1.2.
- Assigns a metric value of 2 to the static route.
- Assigns the name “route1” to the static route.

```
sysname(config)# ip route 172.21.1.104 255.255.0.0 192.168.1.2
sysname(config)# ip route 172.21.1.104 255.255.0.0 192.168.1.2 metric 2
sysname(config)# ip route 172.21.1.104 255.255.0.0 192.168.1.2 name route1
```

## 36.7 Enabling MAC Filtering

You can create a filter to drop packets based on the MAC address of the source or the destination.

**Syntax:**

```
mac-filter name <name> mac <mac-addr> vlan <vlan-id> drop <src/
dst/both>
```

where

<code>name &lt;name&gt;</code>	=	Names the filtering rule.
<code>mac &lt;mac-addr&gt;</code>	=	Specifies the MAC address you want to filter.
<code>vlan &lt;vlan-id&gt;</code>	=	Specifies which VLAN this rule applies to.
<code>drop &lt;src/dst/both&gt;</code>	=	Selects the behavior of the rule.

- `src` - drop packets coming from the specified MAC address
- `dst` - drop packets going to the specified MAC address
- `both` - drop packets coming from or going to the specified MAC address

An example is shown next.

- Create a filtering rule called “filter1”.
- Drop packets coming from and going to MAC address 00:12:00:12:00:12 on VLAN.

```
sysname(config)# mac-filter name filter 1
sysname(config)# mac-filter name filter 1 mac 00:12:00:12:00:12 vlan 1 drop
both
```

## 36.8 Enabling Trunking

To create and enable a trunk, enter `trunk` followed by the ports which you want to group and press [ENTER].

Syntax:

```
trunk <T1|T2|T3|T4|T5|T6>
trunk <T1|T2|T3|T4|T5|T6> interface <port-list>
trunk <T1|T2|T3|T4|T5|T6> lacp
```

where

<code>&lt;T1 T2 T3 T4 T5 T6&gt;</code>	=	Enables the trunk.
<code>&lt;T1 T2 T3 T4 T5 T6&gt;</code> <code>interface &lt;port-list&gt;</code>	=	Places ports in the trunk.
<code>&lt;T1 T2 T3 T4 T5 T6&gt; lacp</code>	=	Enables LACP in the trunk.

An example is shown next.



- Create trunk 1 on the switch.
- Place ports 5-8 in trunk 1.
- Enable dynamic link aggregation (LACP) on trunk 1.

```
sysname(config)# trunk t1
sysname(config)# trunk t1 interface 5-8
sysname(config)# trunk t1 lacp
```

## 36.9 Enabling Port Authentication

To enable a port authentication, you need to specify your RADIUS server details and select the ports which require external authentication. You can set up multiple RADIUS servers and specify how the switch will process authentication requests.

### 36.9.1 RADIUS Server Settings

Configuring multiple RADIUS servers is only available via the command interpreter mode. Use the `radius-server` command to set up your RADIUS server settings.

Syntax:

```
radius-server host <index> <ip>
radius-server host <index> <ip> [acct-port <socket-number>] [key
<key-string>]
radius-server timeout <1-1000>
radius-server mode <priority|round-robin>
```

where

<code>radius-server host &lt;index&gt;</code>	=	Specifies the IP address of the RADIUS server.
<code>&lt;ip&gt;</code>		
<code>[acct-port &lt;socket-number&gt;]</code>	=	Changes the UDP port of the RADIUS server from the default (1812).
<code>[key &lt;key-string&gt;]</code>	=	Specifies a password (up to 32 alphanumeric characters) as the key to be shared between the RADIUS server and the switch.

`radius-server timeout <1-1000>` = Specifies the timeout period (in seconds) the switch will wait for a response from a RADIUS server. If 2 RADIUS servers are configured, this is the total time the switch will wait for a response from either server.

`mode <priority|round-robin>` = Specifies the way the switch will process requests from the clients to the RADIUS server. (Only applicable with multiple RADIUS servers configured.)

`priority` - When a client sends an authentication request through the switch to the RADIUS server. The switch will forward the request to the RADIUS server. If no response within half the timeout period, it will forward the request to the second RADIUS server.

`round-robin` - When a client sends an authentication request through the switch to the RADIUS server. The switch will forward the request to the first RADIUS server. If there is no response within the timeout period, the request times out. The client sends an authentication request again and the switch forwards the request to the second RADIUS server.

See [Section 36.9.2 on page 282](#) for an example.

## 36.9.2 Port Authentication Settings

Use the `port-access-authenticator` command to configure port security on the switch.

Syntax:

```
port-access-authenticator
port-access-authenticator <port-list>
port-access-authenticator <port-list> reauthenticate
port-access-authenticator <port-list> reauth-period <reauth-period>
```

where

`port-access-authenticator` = Enables port authentication on the switch.

`port-access-authenticator <port-list>` = Specifies which ports require authentication.

`reauthenticate` = Enables reauthentication on the port.

`reauth-period <reauth-period>` = Specifies how often a client has to re-enter his or her username and password to stay connected to the port.

An example is shown next.

- Specify RADIUS server 1 with IP address 10.10.10.1, port 1890 and the string secretKey as the password. See [Section 36.9.1 on page 281](#) for more information on RADIUS server commands.
- Specify the timeout period of 30 seconds that the switch will wait for a response from the RADIUS server.
- Enable port authentication on ports 4 to 8.
- Activate reauthentication on the ports.
- Specify 1800 seconds as the interval for client reauthentication.

```
sysname(config)# radius-server host 1 10.10.10.1 acct-port 1890
-> key secretKey
sysname(config)# radius-server timeout 30
sysname(config)# port-access-authenticator
sysname(config)# port-access-authenticator 4-8
sysname(config)# port-access-authenticator 4-8 reauthenticate
sysname(config)# port-access-authenticator 4-8 reauth-period 1800
```



# CHAPTER 37

## Interface Commands

These are some commonly used configuration commands that belong to the `interface` group of commands.

### 37.1 Overview

The interface commands allow you to configure the switch on a port by port basis.

### 37.2 Interface Command Examples

This section provides examples of some frequently used interface commands.

#### 37.2.1 `interface port-channel`

Use this command to enable the specified ports for configuration. Indicate multiple, non-sequential ports separated by a comma. Use a dash to specify a port range.

Syntax:

```
interface port-channel <port-list>
```

An example is shown next.

- Enter the configuration mode.
- Enable ports 1, 3, 4 and 5 for configuration.
- Begin configuring for those ports.

```
sysname# config
sysname(config)# interface port-channel 1,3-5
sysname(config-interface)#
```

#### 37.2.2 `bpdu-control`

Syntax:

```
bpdu-control <peer|tunnel|discard|network>
```

where

`<peer|tunnel|discard|network>` = Type `peer` to process any BPDUs received on these ports.

Type `tunnel` to forward BPDUs received on these ports.

Type `discard` to drop any BPDUs received on these ports.

Type `network` to process a BPDU with no VLAN tag and forward a tagged BPDU.

An example is shown next.

- Enable ports 1, 3, 4 and 5 for configuration.
- Set the BPDU control to `tunnel`, to forward BPDUs received on ports one, three, four and five.

```
sysname(config)# interface port-channel 1,3-5
sysname(config-interface)# bpdu-control tunnel
sysname(config-interface)#
```

### 37.2.3 broadcast-limit

Syntax:

```
broadcast-limit
broadcast-limit <pkt/s>
```

where

= Enables broadcast storm control limit on the switch.

`<pkt/s>` = Limits how many broadcast packet the interface receives per second.

An example is shown next.

- Enable port one for configuration.
- Enable broadcast control.
- Set how many broadband packets the interface receives per second.

```
sysname(config)# interface port-channel 1
sysname(config-interface)# broadcast-limit
sysname(config-interface)# broadcast-limit 21
```

### 37.2.4 bandwidth-limit

The `bandwidth-limit` command enables bandwidth control on the switch.

Syntax:

```
bandwidth-limit
bandwidth-limit pir <Kbps>
bandwidth-limit cir <Kbps>
bandwidth-limit egress <Kbps>
```

where

`pir <Kbps>` = Sets the maximum bandwidth allowed for incoming traffic.

`cir <Kbps>` = Sets the guaranteed bandwidth allowed for incoming traffic.

`egress <Kbps>` = Sets the maximum bandwidth allowed for outgoing traffic (egress) on the switch.

An example is shown next.

- Enable port one for configuration.
- Enable bandwidth control.
- Set the outgoing traffic bandwidth limit to 5000Kbps.
- Set the guaranteed bandwidth allowed for incoming traffic to 4000Kbps.
- Set the maximum bandwidth allowed for incoming traffic to 8000Kbps.

```
sysname(config)# interface port-channel 1
sysname(config-interface)# bandwidth-limit
sysname(config-interface)# bandwidth-limit egress 5000
sysname(config-interface)# bandwidth-limit cir 4000
sysname(config-interface)# bandwidth-limit pir 8000
```

### 37.2.5 mirror

The `mirror` command enables port mirroring on the interface.

Syntax:

```
mirror
mirror dir <ingress|egress|both>
```

where

`dir <ingress|egress|both>` = Enables port mirroring for incoming, outgoing or both incoming and outgoing traffic.

Port mirroring copies traffic from one or all ports to another or all ports for external analysis.

An example is shown next.

- Enable port mirroring.
- Enable the monitor port 3.
- Enable ports 1, 4, 5 and 6 for configuration.
- Enable port mirroring on the ports.
- Enable port mirroring for outgoing traffic. Traffic is copied from ports 1, 4, 5 and 6 to port three in order to examine it in more detail without interfering with the traffic flow on the original ports.

```
sysname(config)# mirror-port
sysname(config)# mirror-port 3
sysname(config)# interface port-channel 1,4-6
sysname(config-interface)# mirror
sysname(config-interface)# mirror dir egress
```

### 37.2.6 gvrp

Syntax:

```
gvrp
```

GVRP (GARP VLAN Registration Protocol) is a registration protocol that defines a way for switches to register necessary VLAN members on ports across the network. Enable this function to permit VLAN groups beyond the local switch.

An example is shown next.

- Enable the IEEE 802.1Q tagged VLAN command to configure tagged VLAN for the switch.
- Enable ports one, three, four and five for configuration.
- Enable GVRP on the interface.

```
sysname(config)# vlan1q gvrp
sysname(config)# interface port-channel 1,3-5
sysname(config-interface)# gvrp
```

### 37.2.7 ingress-check

The `ingress-check` command enables the device to discard incoming frames for VLANs that do not have this port as a member.

Syntax:

```
ingress-check
```

An example is shown next.

- Enable ports 1, 3, 4 and 5 for configuration.



- Enable ingress checking on the interface.

```
sysname(config)# interface port-channel 1,3-5
sysname(config-interface)# ingress-check
```

### 37.2.8 frame-type

Syntax:

```
frame-type <all|tagged|untagged>
```

where

<all|tagged|untagged> = Choose to accept both tagged and untagged incoming frames, just tagged incoming frames or just untagged incoming frames on a port.

An example is shown next.

- Enable ports one, three, four and five for configuration.
- Enable ingress checking on the ports.
- Enable tagged frame-types on the interface.

```
sysname(config)# interface port-channel 1,3-5
sysname(config-interface)# ingress-check
sysname(config-interface)# frame-type tagged
```

### 37.2.9 weight

Syntax:

```
weight <wt1> <wt2> ... <wt8>
```

where

<wt1> <wt2> ... = Sets the interface WFQ weighting. A weight value of one to eight is given to each variable from wt 1 to wt 8.

An example is shown next.

- Enable WFQ queuing on the switch.
- Enable port 2 and ports 6 to 8 for configuration.

- Set the queue weights from Q0 to Q7.

```
sysname# configure
sysname(config)# wfq
sysname(config)# interface port-channel 2,6-8
sysname(config-interface)# weight 8 7 6 5 4 3 2 1
```

### 37.2.10 egress set

Syntax:

```
egress set <port-list>
```

where

<port-list> = Sets the outgoing traffic port list for a port-based VLAN.

An example is shown next.

- Enable port-based VLAN tagging on the switch.
- Enable ports one, three, four and five for configuration.
- Set the outgoing traffic ports as the CPU (0), seven (7), and eight (8).

```
sysname(config)# vlan-type port-based
sysname(config)# interface port-channel 1,3-5
sysname(config-interface)# egress set 0,7,8
```

### 37.2.11 qos priority

Syntax:

```
qos priority <0 .. 7>
```

where

<0 .. 7> = Sets the quality of service priority for a port.

An example is shown next.

- Enable ports one, three, four and five for configuration.
- Set the IEEE 802.1p quality of service priority as four (4).

```
sysname(config)# interface port-channel 1,3-5
sysname(config-interface)# qos priority 4
```

### 37.2.12 name

Syntax:

```
name <port-name-string>
```

where

<port-name-string> = Sets a name for your port interface(s).

An example is shown next.

- Enable ports one, three, four and five for configuration.
- Set a name for the ports.

```
sysname(config)# interface port-channel 1,3-5
sysname(config-interface)# name Test
```

### 37.2.13 speed-duplex

Syntax:

```
speed-duplex <auto|10-half|10-full|100-half|100-full|1000-full>
```

where

<auto|10-half|10-full|100-half|100-full|1000-full> = Sets the duplex mode (half or full) and speed (10, 100 or 1000 Mbps) of the connection on the port. Selecting auto (auto-negotiation) makes one port able to negotiate with a peer automatically to obtain the connection speed and duplex mode that both ends support.

An example is shown next.

- Enable ports one, three, four and five for configuration.
- Set the speed to 100 Mbps in half duplex mode.

```
sysname(config)# interface port-channel 1,3-5
sysname(config-interface)# speed-duplex 100-half
```

### 37.2.14 test

You can perform an interface loopback test on specified ports. The test returns `Passed!` or `Failed!`

An example is shown next.

- Select ports 3-6 for internal loopback test.
- Execute the test command.
- View the results.

```
sysname(config)# interface port-channel 3-6
sysname(config-interface)# test 3-6
Testing internal loopback on port 3 :Passed!
  Ethernet Port 3 Test ok.
Testing internal loopback on port 4 :Passed!
  Ethernet Port 4 Test ok.
Testing internal loopback on port 5 :Passed!
  Ethernet Port 5 Test ok.
Testing internal loopback on port 6 :Passed!
  Ethernet Port 6 Test ok.
```

## 37.3 Interface no Command Examples

Similar to the no commands in the Enable and Config modes, the no commands for the Interface sub mode also disable certain features. In this mode, however, this takes place on a port by port basis.

### 37.3.1 no bandwidth-limit

You can disable bandwidth limit on port 1 simply by placing the no command in front of the bandwidth-limit command.

Syntax:

```
no bandwidth-limit
```

An example is shown next:

- Disable bandwidth limit on port 1.

```
sysname(config)# interface port-channel 1
sysname(config-interface)# no bandwidth-limit
```

# CHAPTER 38

## IEEE 802.1Q Tagged VLAN Commands

This chapter describes the IEEE 802.1Q Tagged VLAN and associated commands.

### 38.1 Configuring Tagged VLAN

The following procedure shows you how to configure tagged VLAN.

- 1 Use the IEEE 802.1Q tagged VLAN commands to configure tagged VLAN for the switch.
  - Use the `vlan <vlan-id>` command to configure or create a VLAN on the switch. The switch automatically enters the `config-vlan` mode. Use the `inactive` command to deactivate the VLAN(s).
  - Use the `interface port-channel <port-list>` command to enter the config-interface mode to set the VLAN settings on a port, then use the `pvid <vlan-id>` command to set the VLAN ID you created for the port-list to that specific port in the PVID table.
  - Use the `exit` command when you are finished configuring the VLAN.

```
sysname (config)# vlan 2000
sysname (config-vlan)# name up1
sysname (config-vlan)# fixed 5-8
sysname (config-vlan)# no untagged 5-8
sysname (config-vlan)# exit
sysname (config)# interface port-channel 5-8
sysname (config-interface)# pvid 2000
sysname (config-interface)# exit
```

- 2 Configure your management VLAN.

- Use the `vlan <vlan-id>` command to create a VLAN (VID 3 in this example) for managing the switch, and the switch will activate the new management VLAN.
- Use the `inactive` command to disable the new management VLAN.

```
sysname (config)# vlan 3
sysname (config-vlan)# inactive
```

## 38.2 Global VLAN1Q Tagged VLAN Configuration Commands

This section shows you how to configure and monitor the IEEE 802.1Q Tagged VLAN.

### 38.2.1 GARP Status

Syntax:

```
show garp
```

This command shows the switch's GARP timer settings, including the join, leave and leave all timers.

An example is shown next.

```
sysname # show garp
GARP Timer
-----
Join Timer = 200
Leave Timer = 600
Leave All Timer = 10000
sysname#
```

### 38.2.2 GARP Timer

Syntax:

```
garp join <msec> leave <msec> leaveall <msec>
```

where

- `join <msec>` = This sets the duration of the Join Period timer for GVRP in milliseconds. Each port has a Join Period timer. The allowed Join Time range is between 100 and 32767 milliseconds; the default is 200 milliseconds.
- `leave <msec>` = This sets the duration of the Leave Period timer for GVRP in milliseconds. Each port has a single Leave Period timer. Leave Time must be two times larger than Join Timer; the default is 600 milliseconds.
- `leaveall <msec>` = This sets the duration of the Leave All Period timer for GVRP in milliseconds. Each port has a single Leave All Period timer. Leave All Timer must be larger than Leave Timer; the default is 10000 milliseconds.

This command sets the switch's GARP timer settings, including the join, leave and leave all timers.

Switches join VLANs by making a declaration. A declaration is made by issuing a Join message using GARP. Declarations are withdrawn by issuing a Leave message. A Leave All message terminates all registrations. GARP timers set declaration timeout values.

The following example sets the Join Timer to 300 milliseconds, the Leave Timer to 800 milliseconds and the Leave All Timer to 11000 milliseconds.

```
sysname (config)# garp join 300 leave 800 leaveall 11000
```

### 38.2.3 GVRP Timer

Syntax:

```
show vlan1q gvrp
```

This command shows the switch's GVRP settings.

An example is shown next.

```
sysname # show vlan1q gvrp
GVRP Support
-----
gvrpEnable = YES
sysname #
```

### 38.2.4 Enable GVRP

Syntax:

```
vlan1q gvrp
```

This command turns on GVRP in order to propagate VLAN information beyond the switch.

### 38.2.5 Disable GVRP

Syntax:

```
no vlan1q gvrp
```

This command turns off GVRP so that the switch does not propagate VLAN information to other switches.

## 38.3 Port VLAN Commands

You must configure the switch port VLAN settings in config-interface mode.

### 38.3.1 Set Port VID

Syntax:

```
pvid <VID>
```

where

<VID> = Specifies the VLAN number between 1 and 4094.

This command sets the default VLAN ID on the port(s).

The following example sets the default VID to 200 on ports 1 to 5.

```
sysname (config)# interface port-channel 1-5
sysname (config-interface)# pvid 200
```

### 38.3.2 Set Acceptable Frame Type

Syntax:

```
frame-type <all|tagged|untagged>
```

where

<all|tagged|untagged> = Specifies all Ethernet frames (tagged and untagged), only tagged Ethernet frames or only untagged Ethernet frames.

This command sets the specified port to accept all Ethernet frames or only those with an IEEE 802.1Q VLAN tag.

The following example sets ports 1 to 5 to accept only tagged frames.

```
sysname (config)# interface port-channel 1-5
sysname (config-interface)# frame-type tagged
```

### 38.3.3 Enable or Disable Port GVRP

Use the `gvrp` command to enable GVRP on the port(s). Use the `no gvrp` command to disable GVRP.

The following example turns off GVRP for ports 1 to 5.

```
sysname (config)# interface port-channel 1-5
sysname (config-interface)# no gvrp
```



### 38.3.4 Modify Static VLAN

Use the following commands in the config-vlan mode to configure the static VLAN table.

Syntax:

```
vlan <vlan-id>
fixed <port-list>
forbidden <port-list>
name <name-str>
normal <port-list>
untagged <port-list>
no fixed <port-list>
no forbidden <port-list>
no untagged <port-list>
```

where

<vlan-id> = The VLAN ID [1 – 4094].  
 <name-str> = A name to identify the SVLAN entry.  
 <port-list> = This is the switch port list.

- Enter *fixed* to register the <port-list> to the static VLAN table with <vlan-id>.
- Enter *normal* to confirm registration of the <port-list> to the static VLAN table with <vlan-id>.
- Enter *forbidden* to block a <port-list> from joining the static VLAN table with <vlan-id>.
- Enter *no fixed* or *no forbidden* to change <port-list> to normal status.
- Enter *untagged* to send outgoing frames without a tag.
- Enter *no untagged* to tag outgoing frames.

#### 38.3.4.1 Modify a Static VLAN Table Example

The following example configures ports 1 to 5 as fixed and untagged ports in VLAN 2000.

```
sysname (config)# vlan 2000
sysname (config-vlan)# fixed 1-5
sysname (config-vlan)# untagged 1-5
```

#### 38.3.4.2 Forwarding Process Example

##### 38.3.4.2.1 Tagged Frames

- 1 First the switch checks the VLAN ID (VID) of tagged frames or assigns temporary VIDs to untagged frames.
- 2 The switch then checks the VID in a frame's tag against the SVLAN table.

- 3 The switch notes what the SVLAN table says (that is, the SVLAN tells the switch whether or not to forward a frame and if the forwarded frames should have tags).
- 4 Then the switch applies the port filter to finish the forwarding decision. This means that frames may be dropped even if the SVLAN says to forward them. Frames might also be dropped if they are sent to a CPE (customer premises equipment) DSL device that does not accept tagged frames.

#### 38.3.4.2.2 Untagged Frames

- 1 An untagged frame comes in from the LAN.
- 2 The switch checks the PVID table and assigns a temporary VID of 1.
- 3 The switch ignores the port from which the frame came, because the switch does not send a frame to the port from which it came. The switch also does not forward frames to “forbidden” ports.
- 4 If after looking at the SVLAN, the switch does not have any ports to which it will send the frame, it won't check the port filter.

### 38.3.5 Delete VLAN ID

Syntax:

```
no vlan <vlan-id>
```

where

<vlan-id> = The VLAN ID [1 – 4094].

This command deletes the specified VLAN ID entry from the static VLAN table. The following example deletes entry 2 in the static VLAN table.

```
sysname (config)# no vlan 2
```

## 38.4 Enable VLAN

Syntax:

```
vlan <vlan-id>
```

This command enables the specified VLAN ID in the SVLAN (Static VLAN) table.

## 38.5 Disable VLAN

Syntax:

```
vlan <vlan-id> inactive
```

This command disables the specified VLAN ID in the SVLAN (Static VLAN) table.

## 38.6 Show VLAN Setting

Syntax:

```
show vlan
```

This command shows the IEEE 802.1Q Tagged SVLAN (Static VLAN) table.

An example is shown next.

- VID is the VLAN identification number.
- Status shows whether the VLAN is static or active.
- Elap-Time is the time since the VLAN was created on the switch.
- The TagCtl section of the last column shows which ports are tagged and which are untagged.

```
sysname# show vlan
The Number of VLAN: 3
Idx. VID  Status  Elap-Time  TagCtl
-----
1   1     Static   0:12:13   Untagged :1-2
                               Tagged   :
1  100    Static   0:00:17   Untagged :
                               Tagged   :1-4
1  200    Static   0:00:07   Untagged :1-2
                               Tagged   :3-8
```



# CHAPTER 39

## Multicast VLAN Registration Commands

This chapter shows you how to use Multicast VLAN Registration (mvr) commands.

### 39.1 Overview

Use the mvr commands in the configuration mode to create and configure multicast VLANs.

**Note:** If you want to enable IGMP snooping see [Section 36.1 on page 271](#).

### 39.2 Create Multicast VLAN

Use the following commands in the config-mvr mode to configure a multicast VLAN group.

Syntax:

```
mvr <vlan-id>
mvr <vlan-id> source-port <port-list>
mvr <vlan-id> receiver-port <port-list>
mvr <vlan-id> inactive
mvr <vlan-id> mode <dynamic|compatible>
mvr <vlan-id> name <name-str>
mvr <vlan-id> tagged <port-list>
mvr <vlan-id> group <name-str> start-address <ip> end-address
<ip>
mvr <vlan-id> exit
```

where

<vlan-id>	=	The VLAN ID [1 – 4094].
source-port <port-list>	=	Specifies the MVR source ports which send and receive multicast traffic.
receiver-port <port-list>	=	Specifies the MVR receiving ports which only receive multicast traffic.
name <name-str>	=	A name to identify the multicast VLAN group.
mode <dynamic compatible>	=	Specifies dynamic (sends IGMP reports to all source ports in the multicast VLAN) or compatible (does not send IGMP reports).

`group name` = A name to identify the MVR IP multicast group .  
`<name-str>`

`start-address` = Specifies the starting IP multicast address of the multicast group in dotted decimal notation.  
`<ip>`

`end-address <ip>` = Specifies the ending IP multicast address of the multicast group in dotted decimal notation. Enter the same IP address as the start-address if you want to configure only one IP address for the multicast group.

- Enter MVR mode. Create a multicast VLAN with the name `multivlan` and the VLAN ID of 3.
- Specify source ports 2, 3, and 5 and receiver ports 6-8.
- Specify dynamic mode for the multicast group.
- Configure MVR multicast group addresses by the name of `ipgroup`.
- Exit MVR mode.

See the following example.

```
sysname(config)# mvr 3 name multivlan
sysname(config-mvr)# source-port 2,3,5 receiver-port 6-8
sysname(config-mvr)# mode dynamic
sysname(config-mvr)# group ipgroup start-address 224.0.0.1
-> end-address 224.0.0.255
sysname(config-mvr)# exit
```

# CHAPTER 40

## Troubleshooting

This chapter covers potential problems and possible remedies.

### 40.1 Problems Starting Up the Switch

**Table 90** Troubleshooting the Start-Up of Your Switch

PROBLEM	CORRECTIVE ACTION
None of the LEDs turn on when you turn on the switch.	Check the power connection and make sure the power source is turned on. If the error persists, you may have a hardware problem. In this case, you should contact your vendor.

### 40.2 Problems Accessing the Switch

**Table 91** Troubleshooting Accessing the Switch

PROBLEM	CORRECTIVE ACTION
I cannot access the switch using Telnet.	Make sure the ports are properly connected. You may have exceeded the maximum number of concurrent Telnet sessions. Close other Telnet session(s) or try connecting again later. Check that you have enabled Telnet service access. If you have configured a secured client IP address, your computer's IP address must match it. Refer to the chapter on access control for details.
I cannot access the web configurator.	The administrator username is "admin". The default administrator password is "1234". The username and password are case-sensitive. Make sure that you enter the correct password and username using the proper casing. If you have changed the password and have now forgotten it, you will need to upload the default configuration file. This restores all of the factory defaults including the password. Check that you have enabled web service access. If you have configured a secured client IP address, your computer's IP address must match it. Refer to the chapter on access control for details. Your computer's and the switch's IP addresses must be on the same subnet. See the following section to check that pop-up windows, JavaScripts and Java permissions are allowed.

## 40.2.1 Pop-up Windows, JavaScripts and Java Permissions

In order to use the web configurator you need to allow:

- Web browser pop-up windows from your device.
- JavaScripts (enabled by default).
- Java permissions (enabled by default).

**Note:** Internet Explorer 6 screens are used here. Screens for other Internet Explorer versions may vary.

### 40.2.1.1 Internet Explorer Pop-up Blockers

You may have to disable pop-up blocking to log into your device.

Either disable pop-up blocking (enabled by default in Windows XP SP (Service Pack) 2) or allow pop-up blocking and create an exception for your device's IP address.

#### 40.2.1.1.1 Disable pop-up Blockers

- 1 In Internet Explorer, select **Tools, Pop-up Blocker** and then select **Turn Off Pop-up Blocker**.

**Figure 117** Pop-up Blocker

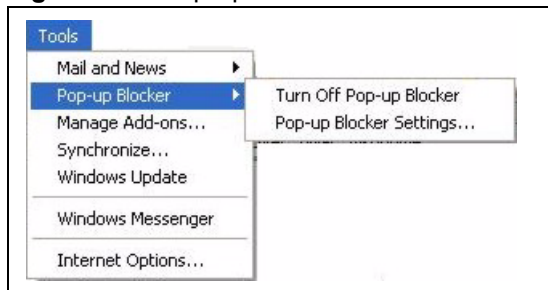

You can also check if pop-up blocking is disabled in the **Pop-up Blocker** section in the **Privacy** tab.

- 1 In Internet Explorer, select **Tools, Internet Options, Privacy**.
- 2 Clear the **Block pop-ups** check box in the **Pop-up Blocker** section of the screen. This disables any web pop-up blockers you may have enabled.

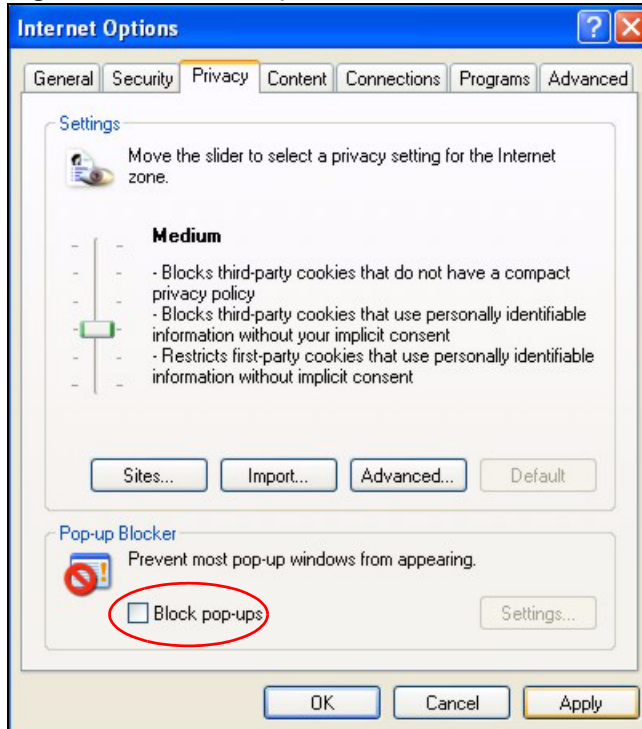

**Figure 118** Internet Options

**3** Click **Apply** to save this setting.

#### 40.2.1.1.2 Enable pop-up Blockers with Exceptions

Alternatively, if you only want to allow pop-up windows from your device, see the following steps.

- 1** In Internet Explorer, select **Tools, Internet Options** and then the **Privacy** tab.
- 2** Select **Settings...** to open the **Pop-up Blocker Settings** screen.

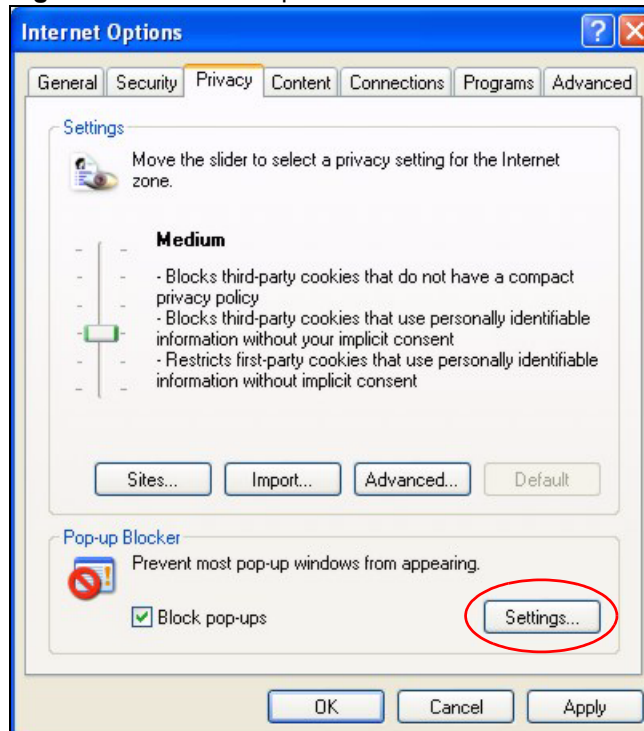
**Figure 119** Internet Options

- 3** Type the IP address of your device (the web page that you do not want to have blocked) with the prefix “http://”. For example, http://192.168.1.1.
- 4** Click **Add** to move the IP address to the list of **Allowed sites**.

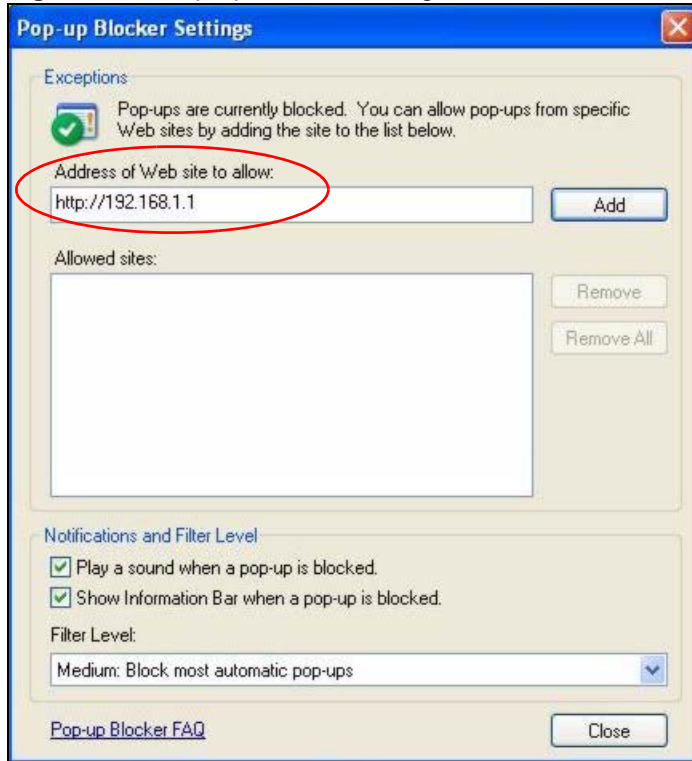
**Figure 120** Pop-up Blocker Settings

**5** Click **Close** to return to the **Privacy** screen.

**6** Click **Apply** to save this setting.

#### 40.2.1.2 JavaScripts

If pages of the web configurator do not display properly in Internet Explorer, check that JavaScripts are allowed.

**1** In Internet Explorer, click **Tools, Internet Options** and then the **Security** tab.

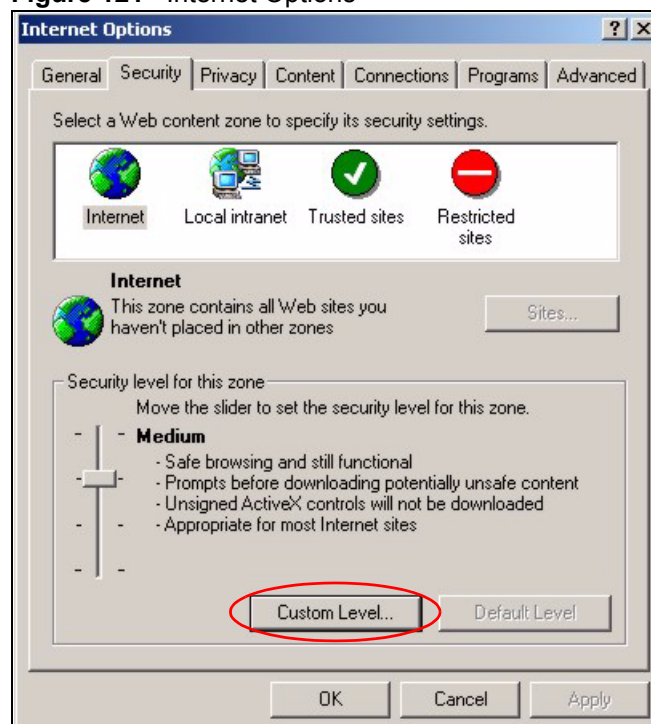
**Figure 121** Internet Options

- 2** Click the **Custom Level...** button.
- 3** Scroll down to **Scripting**.
- 4** Under **Active scripting** make sure that **Enable** is selected (the default).
- 5** Under **Scripting of Java applets** make sure that **Enable** is selected (the default).
- 6** Click **OK** to close the window.

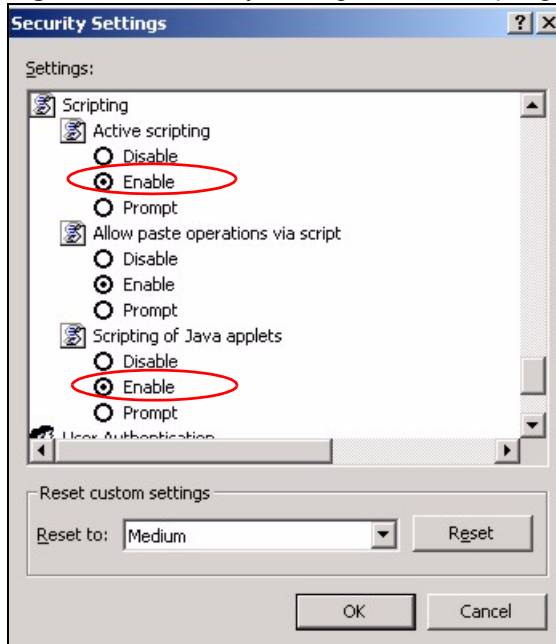
**Figure 122** Security Settings - Java Scripting

### 40.2.1.3 Java Permissions

- 1 From Internet Explorer, click **Tools, Internet Options** and then the **Security** tab.
- 2 Click the **Custom Level...** button.
- 3 Scroll down to **Microsoft VM**.
- 4 Under **Java permissions** make sure that a safety level is selected.
- 5 Click **OK** to close the window.

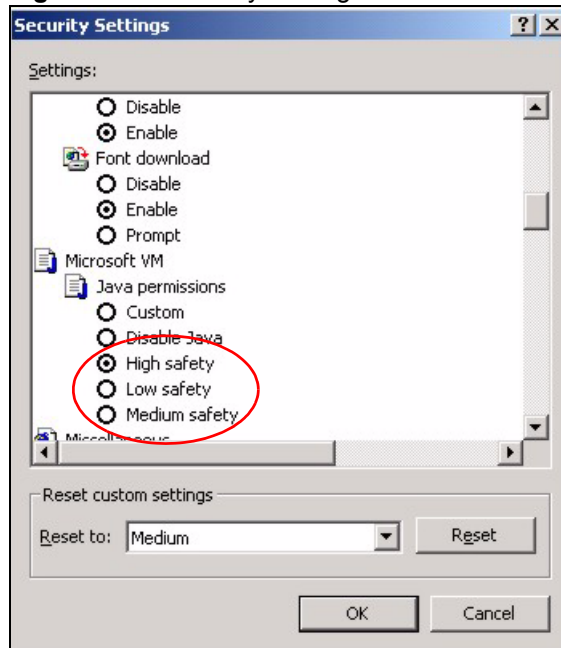
**Figure 123** Security Settings - Java

#### 40.2.1.3.1 JAVA (Sun)

- 1 From Internet Explorer, click **Tools, Internet Options** and then the **Advanced** tab.
- 2 make sure that **Use Java 2 for <applet>** under **Java (Sun)** is selected.
- 3 Click **OK** to close the window.

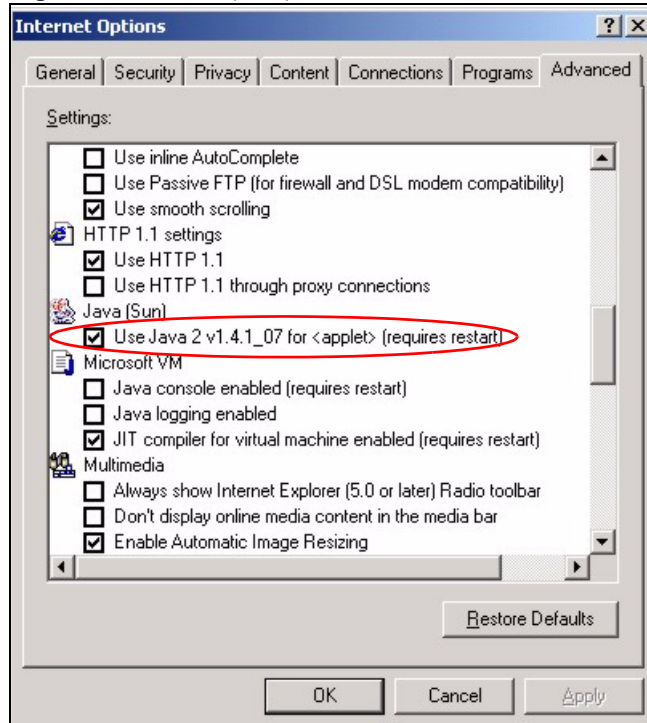
**Figure 124** Java (Sun)

## 40.3 Problems with the Password

**Table 92** Troubleshooting the Password

PROBLEM	CORRECTIVE ACTION
Cannot access the switch.	<p>The password field is case sensitive. Make sure that you enter the correct password using the proper casing.</p> <p>The administrator username is "admin". The default administrator password is "1234". The username and password are case-sensitive. Make sure that you enter the correct password and username using the proper casing. If you have changed the password and have now forgotten it, you will need to upload the default configuration file. This restores all of the factory defaults including the password.</p>





# APPENDIX A

## Product Specifications

These are the switch product specifications.

**Table 93** General Product Specifications

Ethernet Interface	48 10/100 Base-TX interfaces Auto-negotiation Auto-MDI/MDIX Compliant with IEEE 802.3/3u Back pressure flow control for half duplex Flow control for full duplex (IEEE 802.3x) RJ-45 Ethernet cable connector
Gigabit Interface	2 GbE Dual Personality interfaces (Each interface has one 1000Base-T copper port and one Small Form-Factor Pluggable (SFP) fiber port, with one port active at a time.)
Bridging	16K MAC addresses Static MAC address filtering (port lock) Broadcast storm control Limited maximum number of MAC addresses per port
Switching	Switching fabric: 13.6Gbps, non-blocking Max. Frame size: 1522 bytes Forwarding frame: IEEE 802.3, IEEE 802.1q, Ethernet II, PPPoE Prevent the forwarding of corrupted packets
STP RSTP	IEEE 802.1d spanning tree protocol IEEE 802.1w, rapid reconfiguration to recover network failure Up to 6 STP configurations
QoS	IEEE 802.1p Eight priority queues Supports RFC 2475 DiffServ, DSCP to IEEE 802.1p priority mapping
Security	IEEE 802.1x port-based authentication Static MAC Address Forward
VLAN	Port-based VLAN setting Tag-based (IEEE 802.1Q) VLAN Number of VLAN: 4K (256 static VLANs) Supports GVRP Protocol based VLAN support
Link aggregation	Supports IEEE 802.3ad; static and dynamic (LACP) port trunking Up to six groups and each group can aggregate up to eight ports
Port mirroring	All ports support port mirroring
Bandwidth control	Supports rate limiting at 64Kbps increment

**Table 94** Management Specifications

System Control	Alarm/Status surveillance LED indication for alarm and system status Performance monitoring Line speed Four RMON groups (history, statistics, alarms, and events) Throughput monitoring CMP packet transmission Port mirroring and aggregation Spanning Tree Protocol IGMP snooping Firmware upgrade and download through FTP/TFTP Login authorization and security levels (read only and read/write) Self diagnostics FLASH memory
Network Management	CLI through console port and telnet Web-based management Clustering: up to 24 switches can be manage by one IP SNMP RMON groups (history, statistics, alarms and events)
MIB	RFC1213 MIB II RFC1493 Bridge MIB RFC1643 Ethernet MIB RFC1757 Four groups of RMON RFC2011 IP MIB RFC2012 TCP MIB RFC2013 UDP MIB RFC2674 Bridge MIB extension (for IEEE 802.1Q)

**Table 95** Physical and Environmental Specifications

LEDs	Per switch: PWR, SYS, ALM, BPS Per Ethernet port: LNK/ACT, FDX
Dimension	438 mm (W) x 270 mm (D) x 44.45 mm (H) Standard 19" rack mountable
Weight	4.2Kg
Temperature	Operating: 0° C ~ 45° C Storage: -25° C ~ 70° C
Humidity	10 ~ 90% (non-condensing)
Power Supply	Overload protection 100-240VAC, 50/60Hz, 1.5A Max.

**Table 95** Physical and Environmental Specifications (continued)

Safety	ANS/UL 60950-1 CSA 60950-1 EN 60950-1 IEC 60950-1
EMC	FCC Part 15 (Class A) CE EMC (Class A)



# APPENDIX B

## IP Addresses and Subnetting

This appendix introduces IP addresses, IP address classes and subnet masks. You use subnet masks to subdivide a network into smaller logical networks.

### Introduction to IP Addresses

An IP address has two parts: the network number and the host ID. Routers use the network number to send packets to the correct network, while the host ID identifies a single device on the network.

An IP address is made up of four octets, written in dotted decimal notation, for example, 192.168.1.1. (An octet is an 8-digit binary number. Therefore, each octet has a possible range of 00000000 to 11111111 in binary, or 0 to 255 in decimal.)

There are several classes of IP addresses. The first network number (192 in the above example) defines the class of IP address. These are defined as follows:

- Class A: 0 to 127
- Class B: 128 to 191
- Class C: 192 to 223
- Class D: 224 to 239
- Class E: 240 to 255

### IP Address Classes and Hosts

The class of an IP address determines the number of hosts you can have on your network.

- In a class A address the first octet is the network number, and the remaining three octets are the host ID.
- In a class B address the first two octets make up the network number, and the two remaining octets make up the host ID.
- In a class C address the first three octets make up the network number, and the last octet is the host ID.

The following table shows the network number and host ID arrangement for classes A, B and C.

**Table 96** Classes of IP Addresses

IP ADDRESS	OCTET 1	OCTET 2	OCTET 3	OCTET 4
Class A	<b>Network number</b>	Host ID	Host ID	Host ID
Class B	<b>Network number</b>	<b>Network number</b>	Host ID	Host ID
Class C	<b>Network number</b>	<b>Network number</b>	<b>Network number</b>	Host ID

An IP address with host IDs of all zeros is the IP address of the network (192.168.1.0 for example). An IP address with host IDs of all ones is the broadcast address for that network (192.168.1.255 for example). Therefore, to determine the total number of hosts allowed in a network, deduct two as shown next:

- A class C address (1 host octet: 8 host bits) can have  $2^8 - 2$ , or 254 hosts.
- A class B address (2 host octets: 16 host bits) can have  $2^{16} - 2$ , or 65534 hosts.

A class A address (3 host octets: 24 host bits) can have  $2^{24} - 2$  hosts, or approximately 16 million hosts.

## IP Address Classes and Network ID

The value of the first octet of an IP address determines the class of an address.

- Class A addresses have a **0** in the leftmost bit.
- Class B addresses have a **1** in the leftmost bit and a **0** in the next leftmost bit.
- Class C addresses start with **1 1 0** in the first three leftmost bits.
- Class D addresses begin with **1 1 1 0**. Class D addresses are used for multicasting, which is used to send information to groups of computers.
- There is also a class E. It is reserved for future use.

The following table shows the allowed ranges for the first octet of each class. This range determines the number of subnets you can have in a network.

**Table 97** Allowed IP Address Range By Class

CLASS	ALLOWED RANGE OF FIRST OCTET (BINARY)	ALLOWED RANGE OF FIRST OCTET (DECIMAL)
Class A	00000000 to 01111111	0 to 127
Class B	10000000 to 10111111	128 to 191
Class C	11000000 to 11011111	192 to 223
Class D	11100000 to 11101111	224 to 239
Class E (reserved)	11110000 to 11111111	240 to 255

## Subnet Masks

A subnet mask is used to determine which bits are part of the network number, and which bits are part of the host ID (using a logical AND operation).

A subnet mask has 32 bits. If a bit in the subnet mask is a “1” then the corresponding bit in the IP address is part of the network number. If a bit in the subnet mask is “0” then the corresponding bit in the IP address is part of the host ID.

Subnet masks are expressed in dotted decimal notation just like IP addresses. The “natural” masks for class A, B and C IP addresses are as follows.

**Table 98** “Natural” Masks

CLASS	NATURAL MASK
A	255.0.0.0
B	255.255.0.0
C	255.255.255.0

## Subnetting

With subnetting, the class arrangement of an IP address is ignored. For example, a class C address no longer has to have 24 bits of network number and 8 bits of host ID. With subnetting, some of the host ID bits are converted into network number bits.

By convention, subnet masks always consist of a continuous sequence of ones beginning from the leftmost bit of the mask, followed by a continuous sequence of zeros, for a total number of 32 bits.

Since the mask is always a continuous number of ones beginning from the left, followed by a continuous number of zeros for the remainder of the 32 bit mask, you can simply specify the number of ones instead of writing the value of each octet. This is usually specified by writing a “/” followed by the number of bits in the mask after the address.

For example, 192.1.1.0 /25 is equivalent to saying 192.1.1.0 with mask 255.255.255.128.

The following table shows all possible subnet masks for a class “C” address using both notations.

**Table 99** Alternative Subnet Mask Notation

SUBNET MASK	SUBNET MASK “1” BITS	LAST OCTET BIT VALUE	DECIMAL
255.255.255.0	/24	0000 0000	0
255.255.255.128	/25	1000 0000	128
255.255.255.192	/26	1100 0000	192
255.255.255.224	/27	1110 0000	224

**Table 99** Alternative Subnet Mask Notation (continued)

SUBNET MASK	SUBNET MASK "1" BITS	LAST OCTET BIT VALUE	DECIMAL
255.255.255.240	/28	1111 0000	240
255.255.255.248	/29	1111 1000	248
255.255.255.252	/30	1111 1100	252

The first mask shown is the class "C" natural mask. Normally if no mask is specified it is understood that the natural mask is being used.

## Example: Two Subnets

As an example, you have a class "C" address 192.168.1.0 with subnet mask of 255.255.255.0.

**Table 100** Two Subnets Example

IP/SUBNET MASK	NETWORK NUMBER	HOST ID
IP Address	192.168.1.	0
IP Address (Binary)	11000000.10101000.00000001.	00000000
Subnet Mask	255.255.255.	0
Subnet Mask (Binary)	11111111.11111111.11111111.	00000000

The first three octets of the address make up the network number (class "C").

To make two networks, divide the network 192.168.1.0 into two separate subnets by converting one of the host ID bits of the IP address to a network number bit. The "borrowed" host ID bit can be either "0" or "1" thus giving two subnets; 192.168.1.0 with mask 255.255.255.128 and 192.168.1.128 with mask 255.255.255.128.

**Note:** In the following charts, shaded/bolded last octet bit values indicate host ID bits "borrowed" to make network ID bits. The number of "borrowed" host ID bits determines the number of subnets you can have. The remaining number of host ID bits (after "borrowing") determines the number of hosts you can have on each subnet.

**Table 101** Subnet 1

IP/SUBNET MASK	NETWORK NUMBER	LAST OCTET BIT VALUE
IP Address	192.168.1.	0
IP Address (Binary)	11000000.10101000.00000001.	<b>00000000</b>
Subnet Mask	255.255.255.	128
Subnet Mask (Binary)	11111111.11111111.11111111.	<b>10000000</b>



**Table 101** Subnet 1 (continued)

IP/SUBNET MASK	NETWORK NUMBER	LAST OCTET BIT VALUE
Subnet Address: 192.168.1.0	Lowest Host ID: 192.168.1.1	
Broadcast Address: 192.168.1.127	Highest Host ID: 192.168.1.126	

**Table 102** Subnet 2

IP/SUBNET MASK	NETWORK NUMBER	LAST OCTET BIT VALUE
IP Address	192.168.1.	128
IP Address (Binary)	11000000.10101000.00000001.	10000000
Subnet Mask	255.255.255.	128
Subnet Mask (Binary)	11111111.11111111.11111111.	10000000
Subnet Address: 192.168.1.128	Lowest Host ID: 192.168.1.129	
Broadcast Address: 192.168.1.255	Highest Host ID: 192.168.1.254	

Host IDs of all zeros represent the subnet itself and host IDs of all ones are the broadcast address for that subnet, so the actual number of hosts available on each subnet in the example above is  $2^7 - 2$  or 126 hosts for each subnet.

192.168.1.0 with mask 255.255.255.128 is the subnet itself, and 192.168.1.127 with mask 255.255.255.128 is the directed broadcast address for the first subnet. Therefore, the lowest IP address that can be assigned to an actual host for the first subnet is 192.168.1.1 and the highest is 192.168.1.126. Similarly the host ID range for the second subnet is 192.168.1.129 to 192.168.1.254.

## Example: Four Subnets

The above example illustrated using a 25-bit subnet mask to divide a class “C” address space into two subnets. Similarly to divide a class “C” address into four subnets, you need to “borrow” two host ID bits to give four possible combinations (00, 01, 10 and 11). The subnet mask is 26 bits (11111111.11111111.11111111.11000000) or 255.255.255.192. Each subnet contains 6 host ID bits, giving  $2^6 - 2$  or 62 hosts for each subnet (all zeroes is the subnet itself, all ones is the broadcast address on the subnet).

**Table 103** Subnet 1

IP/SUBNET MASK	NETWORK NUMBER	LAST OCTET BIT VALUE
IP Address	192.168.1.	0
IP Address (Binary)	11000000.10101000.00000001.	00000000
Subnet Mask (Binary)	11111111.11111111.11111111.	11000000

**Table 103** Subnet 1 (continued)

IP/SUBNET MASK	NETWORK NUMBER	LAST OCTET BIT VALUE
Subnet Address: 192.168.1.0	Lowest Host ID: 192.168.1.1	
Broadcast Address: 192.168.1.63	Highest Host ID: 192.168.1.62	

**Table 104** Subnet 2

IP/SUBNET MASK	NETWORK NUMBER	LAST OCTET BIT VALUE
IP Address	192.168.1.	64
IP Address (Binary)	11000000.10101000.00000001.	01000000
Subnet Mask (Binary)	11111111.11111111.11111111.	11000000
Subnet Address: 192.168.1.64	Lowest Host ID: 192.168.1.65	
Broadcast Address: 192.168.1.127	Highest Host ID: 192.168.1.126	

**Table 105** Subnet 3

IP/SUBNET MASK	NETWORK NUMBER	LAST OCTET BIT VALUE
IP Address	192.168.1.	128
IP Address (Binary)	11000000.10101000.00000001.	10000000
Subnet Mask (Binary)	11111111.11111111.11111111.	11000000
Subnet Address: 192.168.1.128	Lowest Host ID: 192.168.1.129	
Broadcast Address: 192.168.1.191	Highest Host ID: 192.168.1.190	

**Table 106** Subnet 4

IP/SUBNET MASK	NETWORK NUMBER	LAST OCTET BIT VALUE
IP Address	192.168.1.	192
IP Address (Binary)	11000000.10101000.00000001.	11000000
Subnet Mask (Binary)	11111111.11111111.11111111.	11000000
Subnet Address: 192.168.1.192	Lowest Host ID: 192.168.1.193	
Broadcast Address: 192.168.1.255	Highest Host ID: 192.168.1.254	

## Example Eight Subnets

Similarly use a 27-bit mask to create eight subnets (000, 001, 010, 011, 100, 101, 110 and 111).

The following table shows class C IP address last octet values for each subnet.

**Table 107** Eight Subnets

SUBNET	SUBNET ADDRESS	FIRST ADDRESS	LAST ADDRESS	BROADCAST ADDRESS
1	0	1	30	31
2	32	33	62	63
3	64	65	94	95
4	96	97	126	127
5	128	129	158	159
6	160	161	190	191
7	192	193	222	223
8	224	225	254	255

The following table is a summary for class “C” subnet planning.

**Table 108** Class C Subnet Planning

NO. “BORROWED” HOST BITS	SUBNET MASK	NO. SUBNETS	NO. HOSTS PER SUBNET
1	255.255.255.128 (/25)	2	126
2	255.255.255.192 (/26)	4	62
3	255.255.255.224 (/27)	8	30
4	255.255.255.240 (/28)	16	14
5	255.255.255.248 (/29)	32	6
6	255.255.255.252 (/30)	64	2
7	255.255.255.254 (/31)	128	1

## Subnetting With Class A and Class B Networks.

For class “A” and class “B” addresses the subnet mask also determines which bits are part of the network number and which are part of the host ID.

A class “B” address has two host ID octets available for subnetting and a class “A” address has three host ID octets (see [Table 96 on page 318](#)) available for subnetting.

The following table is a summary for class "B" subnet planning.

**Table 109** Class B Subnet Planning

NO. "BORROWED" HOST BITS	SUBNET MASK	NO. SUBNETS	NO. HOSTS PER SUBNET
1	255.255.128.0 (/17)	2	32766
2	255.255.192.0 (/18)	4	16382
3	255.255.224.0 (/19)	8	8190
4	255.255.240.0 (/20)	16	4094
5	255.255.248.0 (/21)	32	2046
6	255.255.252.0 (/22)	64	1022
7	255.255.254.0 (/23)	128	510
8	255.255.255.0 (/24)	256	254
9	255.255.255.128 (/25)	512	126
10	255.255.255.192 (/26)	1024	62
11	255.255.255.224 (/27)	2048	30
12	255.255.255.240 (/28)	4096	14
13	255.255.255.248 (/29)	8192	6
14	255.255.255.252 (/30)	16384	2
15	255.255.255.254 (/31)	32768	1

# Index

## Numerics

10/1000 Ethernet ports [47](#)  
802.1p priority [85](#)

## A

access control  
  limitation [195](#)  
  login account [198](#)  
  remote management [206](#)  
  service port [205](#)  
  SNMP [196](#)

accounts  
  and modes [232](#)

address learning, MAC [95](#)

Address Resolution Protocol (ARP) [227](#), [228](#)

Address Resolution Protocol. See ARP.

administrator password [199](#)

aggregator ID [127](#)

aging time [79](#)

alternative subnet mask notation [319](#)

applications [37](#)  
  backbone [38](#)  
  bridging [38](#)  
  IEEE 802.1Q VLAN [39](#)  
  switched workgroup [39](#)

ARP [225](#)  
  how it works [225](#)  
  viewing [225](#)

automatic VLAN registration [88](#)

## B

back up, configuration file [190](#)

basic setting [73](#)

BPDUs (Bridge Protocol Data Units) [108](#)

Bridge Protocol Data Units (BPDUs) [108](#)

## C

certifications [4](#)  
  notices [4](#)  
  viewing [4](#)

CFI (Canonical Format Indicator) [87](#)

changing password [58](#)

CLI [229](#)  
  accessing [229](#)  
  syntax conventions [230](#)

cloning a port. See port cloning.

cluster management [35](#), [215](#)  
  and switch passwords [221](#)  
  cluster manager [215](#), [220](#)  
  cluster member [215](#), [221](#)  
  cluster member firmware upgrade [218](#)  
  network example [215](#)  
  setup [219](#)  
  specification [215](#)  
  status [216](#)  
  switch models [215](#)  
  VID [220](#)  
  web configurator [217](#)

cluster manager [215](#)

cluster member [215](#)

Command Line Interface. See CLI.

commands [229](#)  
  accessing [229](#)  
  and configuration file [236](#)  
  and interfaces [255](#)  
  and multicasting [260](#)  
  and passwords [231](#)  
  configuration mode details [243](#)  
  configure tagged VLAN example [293](#)  
  enable mode details [238](#)  
  exit [237](#)  
  forwarding process example [297](#)  
  getting help [233](#)  
  interface mode [255](#)  
  logging in [230](#)  
  modes [232](#)  
  modes summary [233](#)  
  mvr mode details [260](#)  
  static VLAN table example [297](#)  
  summary [237](#)  
  syntax conventions [230](#)  
  user mode details [237](#)  
  using history [236](#)  
  vlan mode details [259](#)

configuration

- change running config [189](#)
  - saving [59](#), [236](#)
- configuration file [60](#), [236](#)
  - and commands [236](#)
  - backup [190](#)
  - restore [60](#), [190](#)
- connections
  - hardware [47](#)
- console port [37](#), [47](#)
  - commands [229](#)
  - settings [50](#), [229](#)
- contact information [8](#)
- copying port settings. See port cloning.
- copyright [3](#)
- CPU management port [98](#)
- CRC (Cyclic Redundant Check) [70](#)
- current date [77](#)
- current time [77](#)
- customer support [8](#)

## D

- DHCP [33](#)
- DHCP relay [179](#)
- DHCP relay agent information [179](#)
- diagnostics [209](#)
  - Ethernet port test [209](#)
  - ping [209](#)
  - system log [209](#)
- DiffServ Code Point. See DSCP
- disclaimer [3](#)
- double-tagged frames [35](#), [159](#)
- DSCP [183](#)
  - and IEEE 802.1p values
    - configuration [184](#)
    - mapping priority [184](#)
    - packet priority
- dual personality interfaces [47](#)
- Dynamic Host Configuration Protocol. See DHCP.
- dynamic link aggregation [125](#)

## E

- egress port [101](#)
- Ethernet broadcast address [225](#)
- Ethernet port test [209](#)
- Ethernet ports [47](#)
  - default settings [48](#)

- extended authentication protocol [131](#)
- external authentication server [131](#)

## F

- FCC interference statement [4](#)
- file transfer using FTP
  - command example [192](#)
- filename convention, configuration [191](#)
- filtering [105](#)
  - rules [105](#)
- filtering database, MAC table [223](#)
- firmware
  - upgrade [189](#), [218](#)
  - version [74](#)
  - viewing [74](#)
- flow control [85](#)
  - back pressure [85](#)
  - IEEE802.3x [85](#)
- frames
  - tagged [94](#)
  - untagged [94](#)
- front panel [47](#)
- FTP [191](#)
  - file transfer procedure [192](#)
  - restrictions over WAN [193](#)

## G

- GARP [88](#)
- GARP status command [294](#)
- GARP terminology [88](#)
- GARP timer [79](#), [88](#)
- GARP VLAN Registration Protocol. See GVRP.
- GBIC ports [38](#), [48](#)
- general setup [75](#)
- Generic Attribute Registration Protocol. See GARP.
- getting help [62](#)
- GMT (Greenwich Mean Time) [77](#)
- GVRP [88](#), [94](#), [288](#)
- gvrp disable [295](#)
- gvrp enable [295](#)
- gvrp status [295](#)

**H**

hardware [37](#)

- connections [47](#)
- front panel [47](#)
- installation [43](#)
- installation precautions [44](#)
- mounting brackets [44](#)
- overview [47](#)
- rack-mounting [44](#)
- rubber feet [43](#)
- transceivers [48, 49](#)

help [62](#)

- in command interpreter [233](#)
- web configurator [62](#)

history

- in command interpreter [236](#)

HTTPS [202](#)

- certificates [202](#)
- implementation [202](#)
- public keys, private keys [202](#)

**I**

IEEE 802.1p, priority [79](#)

IEEE 802.1x [131](#)

- activate [134](#)
- reauthentication [135](#)

IGMP [165](#)

- version [165](#)

IGMP filtering [165](#)

- profile [169](#)
- profiles [167](#)

IGMP snooping [165](#)

- MVR [170](#)

ingress port [101](#)

installation

- freestanding [43](#)
- mounting brackets [44](#)
- precautions [44](#)
- rack-mounting [44](#)
- rubber feet [43](#)

interfaces

- IP [80](#)

Internet Group Multicast Protocol. See IGMP.

IP interface [80](#)

IP setup [80](#)

iStacking [35](#)

**L**

LACP [125](#)

- system priority [128](#)
- timeout [129](#)

LEDs [51](#)

lights [51](#)

limit MAC address learning [138](#)

Link Aggregate Control Protocol (LACP) [125](#)

link aggregation [34, 125](#)

- dynamic [125](#)
- ID information [126](#)
- setup [127](#)
- status [127](#)

link aggregation. See also trunking. [34](#)

lockout [59](#)

log [209](#)

login [53](#)

- password [58](#)
- web configurator [53](#)

login account [198](#)

- Administrator [198](#)
- configuring via web configurator [198](#)
- multiple [198](#)
- non-administrator [199](#)
- number of [198](#)

login password [199](#)

**M**

MAC (Media Access Control) [74](#)

MAC address [74, 225](#)

- maximum number per port [138](#)

MAC address learning [35, 78, 95, 103, 138](#)

- specify limit [138](#)

MAC table [223](#)

- how it works [223](#)
- viewing [224](#)

maintenance [187](#)

- current configuration [187](#)
- main screen [187](#)

Management Information Base (MIB) [196](#)

management interface. See CLI.

management port [47, 101](#)

MIB

- and SNMP [196](#)
- supported MIBs [197](#)

MIB (Management Information Base) [196](#)

mini GBIC ports [48](#)

- connection speed [48](#)
- connector types [48](#)

- transceiver installation [48](#)
- transceiver removal [49](#)
- mirroring ports [123](#)
- modes
  - and accounts [232](#)
  - in command interpreter [232](#)
- mounting brackets [44](#)
- MSA (MultiSource Agreement) [48](#)
- MTU (Multi-Tenant Unit) [77](#)
- multicast [165](#)
- multicast group [169](#)
- multicast settings [167](#)
- multicast VLAN [173](#)
- multicasting
  - 802.1 priority [167](#)
  - addresses [165](#)
  - setup [166](#)
- Multiple Spanning Tree Protocol [109](#)
- MVR [170](#)
  - configuration [171](#)
  - configuration example [175](#)
  - group configuration [173](#)
  - how it works [171](#)
  - modes [171](#)
  - network example [170](#)
  - ports [170](#)
- MVR (Multicast VLAN Registration) [170](#)

## N

- network management system (NMS) [196](#)
- NTP (RFC-1305) [77](#)

## P

- password [58](#)
  - changing [58](#)
- ping, test connection [209](#)
- port authentication [131](#)
  - IEEE802.1x [134](#)
  - RADIUS server [133](#)
- port based VLAN type [78](#)
- port cloning [227](#), [228](#)
  - advanced settings [227](#), [228](#)
  - basic settings [227](#), [228](#)
- port details [68](#)
- port isolation [94](#), [101](#)
- port mirroring [34](#), [123](#), [257](#)
  - and commands [287](#)

- port redundancy [125](#)
- port security [35](#)
  - limit MAC address learning [138](#)
- port setup [83](#)
- port status [67](#)
- Port VID
  - Default for all ports [256](#)
- port VLAN trunking [89](#)
- port-based VLAN [98](#)
  - all connected [101](#)
  - port isolation [101](#)
  - settings wizard [101](#)
- ports
  - and MVR [170](#)
  - diagnostics [209](#)
  - GBIC [38](#)
  - mirroring [123](#)
  - speed/duplex [84](#)
  - standby [125](#)
- priority level [79](#)
- priority, queue assignment [79](#)
- product registration [7](#)
- Product specification [313](#)
- protocol based VLAN [95](#)
  - and IEEE 802.1Q tagging [95](#)
  - example [97](#)
  - hexadecimal notation for protocols [96](#)
  - isolate traffic [95](#)
  - priority [96](#)
- PVID (Priority Frame) [87](#), [94](#)

## Q

- queue weight [156](#)
- queuing [34](#), [155](#)
  - SPQ [156](#)
  - WFQ [156](#)
  - WRR [156](#)
- queuing algorithm [155](#), [157](#)
- queuing method [155](#), [157](#)

## R

- rack-mounting [44](#)
- RADIUS [131](#)
  - advantages [131](#)
  - network example [131](#)
  - server [131](#)
  - settings [133](#)
- Rapid Spanning Tree Protocol (RSTP). See STP.



reboot  
 load configuration [189](#)  
 reboot system [189](#)  
 registration  
 product [7](#)  
 related documentation [31](#)  
 Remote Authentication Dial In User Service. See RADIUS.  
 remote management [206](#)  
 service [207](#)  
 trusted computers [207](#)  
 reset [60](#), [188](#)  
 to factory default settings [188](#)  
 restore configuration [60](#)  
 restoring configuration [190](#)  
 RFC 3164 [211](#)  
 RFC 3580 [132](#)  
 round robin scheduling [156](#)  
 RSTP [34](#), [107](#)  
 See also Spanning Tree Protocol.  
 rubber feet  
 installation [43](#)

## S

safety warnings [5](#)  
 saving configuration [59](#)  
 Secure Shell See SSH  
 service access control [205](#)  
 service port [206](#)  
 Service Provider Tag Protocol Identifier [161](#)  
 Service Provider's Network [159](#)  
 Simple Network Management Protocol, See SNMP  
 SNMP [196](#)  
 agent [196](#)  
 and MIB [196](#)  
 communities [198](#)  
 management model [196](#)  
 manager [196](#)  
 MIB [197](#)  
 network components [196](#)  
 object variables [196](#)  
 protocol operations [196](#)  
 setup [198](#)  
 traps [197](#)  
 versions supported [196](#)  
 SNMP traps [197](#)  
 SP TPID [161](#)  
 Spanning Tree Protocol (STP) [107](#)  
 Spanning Tree Protocol. See STP.  
 SPQ (Strict Priority Queuing) [156](#)  
 SSH  
 encryption methods [201](#)  
 how it works [200](#)  
 implementation [201](#)  
 SSH (Secure Shell) [200](#)  
 SSL (Secure Socket Layer) [202](#)  
 standby ports [125](#)  
 static MAC address [35](#), [103](#)  
 static MAC forwarding [95](#), [103](#)  
 static routes [181](#)  
 cost of transmission [181](#)  
 TCP/IP parameters [181](#)  
 static VLAN [91](#)  
 control [92](#)  
 tagging [92](#)  
 status [54](#)  
 LED [51](#)  
 link aggregation [127](#)  
 port [67](#)  
 port details [68](#)  
 STP [112](#), [115](#)  
 VLAN [90](#)  
 status lights [51](#)  
 status screen [54](#)  
 STP [34](#), [107](#)  
 bridge ID [113](#), [116](#)  
 bridge priority [111](#), [114](#)  
 configuration [110](#), [113](#)  
 designated bridge [108](#)  
 forwarding delay [112](#), [115](#)  
 Hello BPDU [108](#)  
 Hello Time [112](#), [113](#), [114](#), [116](#)  
 how it works [108](#)  
 Max Age [112](#), [113](#), [115](#), [116](#)  
 path cost [107](#), [112](#), [115](#)  
 port priority [112](#), [115](#)  
 port state [108](#)  
 root port [108](#)  
 status [112](#), [115](#)  
 terminology [107](#)  
 subnet [317](#)  
 subnet mask [319](#)  
 subnetting [319](#)  
 switch  
 lockout [59](#)  
 switch reset [60](#)  
 switch setup [78](#)  
 sys commands  
 examples [263](#), [275](#)  
 sys log disp [275](#)  
 sys sw mac list [265](#)  
 syslog [211](#)  
 protocol [211](#)  
 server setup [212](#)  
 settings [211](#)

- setup [211](#)
- severity levels [211](#)
- system information [73](#)
- system log [209](#)
- system login [53](#)
- system reboot [189](#)

## T

- tagged VLAN [87](#)
- Telnet
  - commands [230](#)
  - logging in [230](#)
  - management [230](#)
- time
  - current [77](#)
  - time server [77](#)
  - time zone [77](#)
- Time (RFC-868) [77](#)
- time server [77](#)
- time service protocol [77](#)
  - time format [77](#)
- time zone [77](#)
- trademarks [3](#)
- transceiver
  - installation [48](#)
  - removal [49](#)
- traps
  - destination [198](#)
- traps, SNMP [197](#)
- trunk group [125](#)
- trunking [34](#), [125](#)
- tunnel protocol attribute [132](#)

## U

- UTC (Universal Time Coordinated) [77](#)

## V

- Vendor Specific Attribute (VSA) [131](#)
- ventilation [43](#)
- ventilation holes
  - hardware [43](#)
- VID [87](#), [90](#), [91](#), [161](#)
  - number of possible VIDs [87](#)

- priority frame [87](#)
- VID (VLAN Identifier) [87](#)
- VLAN [77](#), [87](#)
  - acceptable frame type [94](#)
  - automatic registration [88](#)
  - ID [87](#)
  - ingress filtering [94](#)
  - introduction [77](#)
  - number of VLANs [90](#)
  - port isolation [94](#)
  - port number [91](#)
  - port settings [93](#)
  - port-based VLAN [98](#)
  - static VLAN [91](#)
  - status [90](#), [91](#)
  - tagged [87](#)
  - trunking [89](#)
  - type [78](#), [89](#)
- VLAN (Virtual Local Area Network) [33](#), [77](#)
- VLAN stacking [35](#), [159](#)
- VLAN trunking [94](#)
- VLAN, protocol based. See protocol based VLAN.
- vlan1q port accept [296](#)
- vlan1q port gvrp [296](#)
- vlan1q svlan active [298](#)
- vlan1q svlan delentry [298](#)
- vlan1q svlan inactive [299](#)
- vlan1q svlan list [299](#)
- vlan1q svlan setentry [272](#), [301](#)

## W

- warning lights [51](#)
- warranty [7](#)
  - note [7](#)
- web configurator
  - getting help [62](#)
  - help [62](#)
  - home [54](#)
  - logging out [62](#)
  - login [53](#)
  - navigation panel [55](#)
  - screen summary [56](#)
- weight, queuing [156](#)
- Weighted Round Robin Scheduling (WRR) [156](#)
- WFQ (Weighted Fair Scheduling) [156](#)
- WRR (Weighted Round Robin Scheduling) [156](#)