

ES-3148

Intelligent Layer 2+ Switch

User's Guide

3.60
12/2005
Edition 2

The logo for ZyXEL, featuring the word "ZyXEL" in a bold, blue, sans-serif font. The "Zy" is lowercase and the "XEL" is uppercase.

Copyright

Copyright © 2005 by ZyXEL Communications Corporation.

The contents of this publication may not be reproduced in any part or as a whole, transcribed, stored in a retrieval system, translated into any language, or transmitted in any form or by any means, electronic, mechanical, magnetic, optical, chemical, photocopying, manual, or otherwise, without the prior written permission of ZyXEL Communications Corporation.

Published by ZyXEL Communications Corporation. All rights reserved.

Disclaimer

ZyXEL does not assume any liability arising out of the application or use of any products, or software described herein. Neither does it convey any license under its patent rights nor the patent rights of others. ZyXEL further reserves the right to make changes in any products described herein without notice. This publication is subject to change without notice.

Certifications

FCC Statement

This switch complies with Part 15 of the FCC rules. Operation is subject to the following two conditions:

- 1 This switch may not cause harmful interference.
- 2 This switch must accept any interference received, including interference that may cause undesired operations.

FCC Warning

This equipment has been tested and found to comply with the limits for a Class A digital switch, pursuant to Part 15 of the FCC Rules. These limits are designed to provide reasonable protection against harmful interference in a commercial environment. This equipment generates, uses, and can radiate radio frequency energy and, if not installed and used in accordance with the instruction manual, may cause harmful interference to radio communications. Operation of this equipment in a residential area is likely to cause harmful interference in which case the user will be required to correct the interference at his own expense.

CE Mark Warning:

This is a class A product. In a domestic environment this product may cause radio interference in which case the user may be required to take adequate measures.

Taiwanese BSMI (Bureau of Standards, Metrology and Inspection) A Warning:

警告使用者
這是甲類的資訊產品, 在居住的環境使用時,
可能造成射頻干擾, 在這種情況下,
使用者會被要求採取某些適當的對策.

Notice 1

Changes or modifications not expressly approved by the party responsible for compliance could void the user's authority to operate the equipment.

This Class A digital apparatus complies with Canadian ICES-003.

Cet appareil numérique de la classe A est conforme à la norme NMB-003 du Canada.

Certifications

- 1 Go to www.zyxel.com.
- 2 Select your product from the drop-down list box on the ZyXEL home page to go to that product's page.
- 3 Select the certification you wish to view from this page.

Safety Warnings

For your safety, be sure to read and follow all warning notices and instructions.

- To reduce the risk of fire, use only No. 26 AWG (American Wire Gauge) or larger telecommunication line cord.
- Do NOT open the device or unit. Opening or removing covers can expose you to dangerous high voltage points or other risks. ONLY qualified service personnel can service the device. Please contact your vendor for further information.
- Use ONLY the dedicated power supply for your device. Connect the power cord or power adaptor to the right supply voltage (110V AC in North America or 230V AC in Europe).
- Do NOT use the device if the power supply is damaged as it might cause electrocution.
- If the power supply is damaged, remove it from the power outlet.
- Do NOT attempt to repair the power supply. Contact your local vendor to order a new power supply.
- Place connecting cables carefully so that no one will step on them or stumble over them. Do NOT allow anything to rest on the power cord and do NOT locate the product where anyone can walk on the power cord.
- If you wall mount your device, make sure that no electrical, gas or water pipes will be damaged.
- Do NOT install nor use your device during a thunderstorm. There may be a remote risk of electric shock from lightning.
- Do NOT expose your device to dampness, dust or corrosive liquids.
- Do NOT use this product near water, for example, in a wet basement or near a swimming pool.
- Make sure to connect the cables to the correct ports.
- Do NOT obstruct the device ventilation slots, as insufficient airflow may harm your device.
- Do NOT store things on the device.
- Connect ONLY suitable accessories to the device.

ZyXEL Limited Warranty

ZyXEL warrants to the original end user (purchaser) that this product is free from any defects in materials or workmanship for a period of up to two years from the date of purchase. During the warranty period, and upon proof of purchase, should the product have indications of failure due to faulty workmanship and/or materials, ZyXEL will, at its discretion, repair or replace the defective products or components without charge for either parts or labor, and to whatever extent it shall deem necessary to restore the product or components to proper operating condition. Any replacement will consist of a new or re-manufactured functionally equivalent product of equal or higher value, and will be solely at the discretion of ZyXEL. This warranty shall not apply if the product has been modified, misused, tampered with, damaged by an act of God, or subjected to abnormal working conditions.

Note

Repair or replacement, as provided under this warranty, is the exclusive remedy of the purchaser. This warranty is in lieu of all other warranties, express or implied, including any implied warranty of merchantability or fitness for a particular use or purpose. ZyXEL shall in no event be held liable for indirect or consequential damages of any kind to the purchaser.

To obtain the services of this warranty, contact ZyXEL's Service Center for your Return Material Authorization number (RMA). Products must be returned Postage Prepaid. It is recommended that the unit be insured when shipped. Any returned products without proof of purchase or those with an out-dated warranty will be repaired or replaced (at the discretion of ZyXEL) and the customer will be billed for parts and labor. All repaired or replaced products will be shipped by ZyXEL to the corresponding return address, Postage Paid. This warranty gives you specific legal rights, and you may also have other rights that vary from country to country.

Registration

Register your product online to receive e-mail notices of firmware upgrades and information at www.zyxel.com for global products, or at www.us.zyxel.com for North American products.

Customer Support

Please have the following information ready when you contact customer support.

- Product model and serial number.
- Warranty Information.
- Date that you received your device.
- Brief description of the problem and the steps you took to solve it.

METHOD	SUPPORT E-MAIL	TELEPHONE*	WEB SITE	REGULAR MAIL
LOCATION	SALES E-MAIL	FAX	FTP SITE	
CORPORATE HEADQUARTERS (WORLDWIDE)	support@zyxel.com.tw	+886-3-578-3942	www.zyxel.com www.europe.zyxel.com	ZyXEL Communications Corp. 6 Innovation Road II Science Park Hsinchu 300 Taiwan
	sales@zyxel.com.tw	+886-3-578-2439	ftp.zyxel.com ftp.europe.zyxel.com	
CZECH REPUBLIC	info@cz.zyxel.com	+420-241-091-350	www.zyxel.cz	ZyXEL Communications Czech s.r.o. Modranská 621 143 01 Praha 4 - Modrany Ceská Republika
	info@cz.zyxel.com	+420-241-091-359		
DENMARK	support@zyxel.dk	+45-39-55-07-00	www.zyxel.dk	ZyXEL Communications A/S Columbusvej 2860 Soeborg Denmark
	sales@zyxel.dk	+45-39-55-07-07		
FINLAND	support@zyxel.fi	+358-9-4780-8411	www.zyxel.fi	ZyXEL Communications Oy Malminkaari 10 00700 Helsinki Finland
	sales@zyxel.fi	+358-9-4780 8448		
FRANCE	info@zyxel.fr	+33-4-72-52-97-97	www.zyxel.fr	ZyXEL France 1 rue des Vergers Bat. 1 / C 69760 Limonest France
		+33-4-72-52-19-20		
GERMANY	support@zyxel.de	+49-2405-6909-0	www.zyxel.de	ZyXEL Deutschland GmbH. Adenauerstr. 20/A2 D-52146 Wuerselen Germany
	sales@zyxel.de	+49-2405-6909-99		
HUNGARY	support@zyxel.hu	+36-1-3361649	www.zyxel.hu	ZyXEL Hungary 48, Zoldlomb Str. H-1025, Budapest Hungary
	info@zyxel.hu	+36-1-3259100		
KAZAKHSTAN	http://zyxel.kz/support	+7-3272-590-698	www.zyxel.kz	ZyXEL Kazakhstan 43, Dostyk ave., Office 414 Dostyk Business Centre 050010, Almaty Republic of Kazakhstan
	sales@zyxel.kz	+7-3272-590-689		
NORTH AMERICA	support@zyxel.com	1-800-255-4101 +1-714-632-0882	www.us.zyxel.com	ZyXEL Communications Inc. 1130 N. Miller St. Anaheim CA 92806-2001 U.S.A.
	sales@zyxel.com	+1-714-632-0858	ftp.us.zyxel.com	
NORWAY	support@zyxel.no	+47-22-80-61-80	www.zyxel.no	ZyXEL Communications A/S Niils Hansens vei 13 0667 Oslo Norway
	sales@zyxel.no	+47-22-80-61-81		

METHOD	SUPPORT E-MAIL	TELEPHONE*	WEB SITE	REGULAR MAIL
LOCATION	SALES E-MAIL	FAX	FTP SITE	
POLAND	info@pl.zyxel.com	+48 (22) 333 8250	www.pl.zyxel.com	ZyXEL Communications ul. Okrzei 1A 03-715 Warszawa Poland
		+48 (22) 333 8251		
RUSSIA	http://zyxel.ru/support	+7-095-542-89-29	www.zyxel.ru	ZyXEL Russia Ostrovityanova 37a Str. Moscow, 117279 Russia
	sales@zyxel.ru	+7-095-542-89-25		
SPAIN	support@zyxel.es	+34-902-195-420	www.zyxel.es	ZyXEL Communications Arte, 21 5ª planta 28033 Madrid Spain
	sales@zyxel.es	+34-913-005-345		
SWEDEN	support@zyxel.se	+46-31-744-7700	www.zyxel.se	ZyXEL Communications A/S Sjöporten 4, 41764 Göteborg Sweden
	sales@zyxel.se	+46-31-744-7701		
UKRAINE	support@ua.zyxel.com	+380-44-247-69-78	www.ua.zyxel.com	ZyXEL Ukraine 13, Pimonenko Str. Kiev, 04050 Ukraine
	sales@ua.zyxel.com	+380-44-494-49-32		
UNITED KINGDOM	support@zyxel.co.uk	+44-1344 303044 08707 555779 (UK only)	www.zyxel.co.uk	ZyXEL Communications UK Ltd., 11 The Courtyard, Eastern Road, Bracknell, Berkshire, RG12 2XB, United Kingdom (UK)
	sales@zyxel.co.uk	+44-1344 303034	ftp.zyxel.co.uk	

* "+" is the (prefix) number you enter to make an international telephone call.

Table of Contents

Copyright	1
Certifications	2
ZyXEL Limited Warranty	4
Customer Support.....	5
Preface	25
Chapter 1	
Getting to Know Your Switch	27
1.1 Introduction	27
1.2 Software Features	27
1.3 Hardware Features	30
1.4 Applications	31
1.4.1 Backbone Application	31
1.4.2 Bridging Example	32
1.4.3 High Performance Switched Example	32
1.4.4 IEEE 802.1Q VLAN Application Examples	33
1.4.4.1 Tag-based VLAN Example	33
1.4.4.2 VLAN Shared Server Example	34
Chapter 2	
Hardware Installation and Connection.....	35
2.1 Freestanding Installation	35
2.2 Mounting the Switch on a Rack	36
2.2.1 Rack-mounted Installation Requirements	36
2.2.1.1 Precautions	36
2.2.2 Attaching the Mounting Brackets to the Switch	36
2.2.3 Mounting the Switch on a Rack	37
Chapter 3	
Hardware Overview.....	39
3.1 Panel Connections	39
3.1.1 Console Port	40
3.1.2 Ethernet Ports	40

3.1.2.1 Default Ethernet Settings	40
3.1.3 Mini-GBIC Slots	41
3.1.3.1 Transceiver Installation	41
3.1.3.2 Transceiver Removal	42
3.1.4 Power Connector	42
3.1.5 External Backup Power Supply Connector	42
3.2 Panel LEDs	43
Chapter 4	
The Web Configurator.....	45
4.1 Introduction	45
4.2 System Login	45
4.3 The Status Screen	46
4.3.1 Change Your Password	50
4.4 Switch Lockout	50
4.5 Resetting the Switch	51
4.5.1 Reload the Configuration File	51
4.5.2 Reset to the Factory Defaults	52
4.6 Logging Out of the Web Configurator	53
4.7 Help	53
Chapter 5	
Initial Setup Example	55
5.1 Overview	55
5.1.1 Creating a VLAN	55
5.1.2 Setting Port VID	57
5.1.3 Configuring Switch Management IP Address	58
Chapter 6	
System Status and Port Statistics	59
6.1 Overview	59
6.2 Port Status Summary	59
6.2.1 Status: Port Details	61
Chapter 7	
Basic Setting	65
7.1 Overview	65
7.2 System Information	65
7.3 General Setup	67
7.4 Introduction to VLANs	69
7.5 Switch Setup Screen	70
7.6 IP Setup	71
7.6.1 Management IP Addresses	72

7.7 Port Setup	74
Chapter 8	
VLAN	77
8.1 Introduction to IEEE 802.1Q Tagged VLAN	77
8.1.1 Forwarding Tagged and Untagged Frames	77
8.2 Automatic VLAN Registration	78
8.2.1 GARP	78
8.2.1.1 GARP Timers	78
8.2.2 GVRP	78
8.3 Port VLAN Trunking	79
8.4 Select the VLAN Type	79
8.5 Static VLAN	80
8.5.1 Static VLAN Status	80
8.5.2 Configure a Static VLAN	81
8.5.3 Configure VLAN Port Settings	83
8.6 Port-based VLAN Setup	85
8.6.1 Configure a Port-based VLAN	86
Chapter 9	
Static MAC Forwarding	89
9.1 Overview	89
9.2 Configuring Static MAC Forwarding	89
Chapter 10	
Filtering	91
10.1 Introduction to Filtering	91
10.2 Configure a Filtering Rule	91
Chapter 11	
Spanning Tree Protocol	93
11.1 STP/RSTP Overview	93
11.1.1 STP Terminology	93
11.1.2 How STP Works	94
11.1.3 STP Port States	94
11.2 STP Status	94
11.3 Configure STP	96
Chapter 12	
Bandwidth Control	99
12.1 Bandwidth Control Overview	99
12.1.1 CIR and PIR	99
12.2 Bandwidth Control Setup	99

Chapter 13	
Broadcast Storm Control.....	103
13.1 Overview	103
13.2 Broadcast Storm Control Setup	103
Chapter 14	
Mirroring	107
14.1 Introduction to Port Mirroring	107
14.2 Port Mirroring Setup	107
Chapter 15	
Link Aggregation.....	111
15.1 Introduction to Link Aggregation	111
15.2 Dynamic Link Aggregation	111
15.2.1 Link Aggregation ID	112
15.3 Link Aggregation Status	112
15.4 Link Aggregation Setup	113
Chapter 16	
Port Authentication.....	117
16.1 Introduction to Authentication	117
16.1.1 RADIUS	117
16.2 Port Authentication Configuration	117
16.2.1 Configuring RADIUS Server Settings	118
16.2.2 Activate IEEE 802.1x Security	118
Chapter 17	
Port Security.....	121
17.1 About Port Security	121
17.2 Port Security Setup	121
Chapter 18	
Access Control.....	125
18.1 Overview	125
18.2 The Access Control Main Screen	125
18.3 About SNMP	126
18.3.1 Supported MIBs	127
18.3.2 SNMP Traps	127
18.3.3 Configuring SNMP	127
18.3.4 Setting Up Login Accounts	128
18.4 SSH Overview	130
18.5 How SSH works	130
18.6 SSH Implementation on the Switch	131

18.6.1 Requirements for Using SSH	131
18.7 Introduction to HTTPS	131
18.8 HTTPS Example	132
18.8.1 Internet Explorer Warning Messages	132
18.8.2 Netscape Navigator Warning Messages	133
18.8.3 The Main Screen	134
18.9 Service Port Access Control	135
18.10 Remote Management	136
Chapter 19	
Queuing Method.....	139
19.1 Introduction to Queuing	139
19.1.1 Strictly Priority	139
19.1.2 Weighted Fair Scheduling	139
19.2 Configuring Queuing	140
Chapter 20	
Classifier.....	143
20.1 About the Classifier and QoS	143
20.2 Configuring the Classifier	143
20.3 Viewing and Editing Classifier Configuration	146
20.4 Classifier Example	147
Chapter 21	
Policy Rule.....	149
21.1 About Policy Rules	149
21.1.1 DiffServ	149
21.1.2 DSCP and Per-Hop Behavior	149
21.2 Configuring Policy Rules	150
21.3 Viewing and Editing Policy Configuration	152
21.4 Policy Example	153
Chapter 22	
VLAN Stacking.....	155
22.1 Introduction	155
22.1.1 VLAN Stacking Example	155
22.2 VLAN Stacking Port Roles	156
22.3 VLAN Tag Format	156
22.3.1 Frame Format	157
22.4 Configuring VLAN Stacking	158

Chapter 23	
Multicast	161
23.1 Overview	161
23.1.1 IP Multicast Addresses	161
23.1.2 IGMP Filtering	161
23.1.3 IGMP Snooping	161
23.2 Multicast Status	162
23.3 Multicast Setup	162
23.4 IGMP Filtering Profile	164
23.5 MVR Overview	166
23.5.1 Types of MVR Ports	166
23.5.2 MVR Modes	166
23.5.3 How MVR Works	167
23.6 General MVR Configuration	167
23.7 MVR Group Configuration	169
23.7.1 MVR Configuration Example	171
Chapter 24	
DHCP Relay	175
24.1 DHCP Relay Overview	175
24.1.1 DHCP Relay Agent Information	175
24.2 DHCP Relay Configuration	175
Chapter 25	
Static Route	177
25.1 Configuring	177
Chapter 26	
Maintenance	179
26.1 The Maintenance Screen	179
26.2 Firmware Upgrade	179
26.3 Restore a Configuration File	180
26.4 Backing Up a Configuration File	180
26.5 Load Factory Defaults	181
26.6 Reboot System	181
26.7 FTP Command Line	182
26.7.1 Filename Conventions	182
26.7.1.1 Example FTP Commands	183
26.7.2 FTP Command Line Procedure	183
26.7.3 GUI-based FTP Clients	184
26.7.4 FTP Restrictions	184

Chapter 27	
Diagnostic	185
27.1 Diagnostic	185
Chapter 28	
Cluster Management	187
28.1 Overview	187
28.2 Cluster Management Status	188
28.2.1 Cluster Member Switch Management	189
28.2.1.1 Uploading Firmware to a Cluster Member Switch	189
28.3 Configuring Cluster Management	190
Chapter 29	
MAC Table	193
29.1 Overview	193
29.2 Viewing the MAC Table	194
Chapter 30	
ARP Table	195
30.1 Overview	195
30.1.1 How ARP Works	195
30.2 Viewing the ARP Table	195
Chapter 31	
Introducing the Commands	197
31.1 Overview	197
31.1.1 Switch Configuration File	197
31.2 Accessing the CLI	197
31.2.1 Access Priority	198
31.2.2 The Console Port	198
31.2.2.1 Initial Screen	198
31.2.3 Telnet	198
31.3 The Login Screen	199
31.4 Command Syntax Conventions	199
31.5 Getting Help	200
31.5.1 List of Available Commands	200
31.5.2 Detailed Command Information	201
31.6 Command Modes	201
31.7 Using Command History	202
31.8 Saving Your Configuration	202
31.8.1 Logging Out	203
31.9 Command Summary	203
31.9.1 User Mode	203

31.9.2 Enable Mode	204
31.9.3 General Configuration Mode	208
31.9.4 interface port-channel Commands	218
31.9.5 config-vlan Commands	221
31.9.6 mvr Commands	223
Chapter 32	
Command Examples	225
32.1 Overview	225
32.2 show Commands	225
32.2.1 show system-information	225
32.2.2 show ip	226
32.2.3 show logging	226
32.2.4 show interface	227
32.2.5 show mac address-table	227
32.3 ping	228
32.4 traceroute	229
32.5 Enabling RSTP	229
32.6 Configuration File Maintenance	230
32.6.1 Using a Different Configuration File	230
32.6.2 Resetting to the Factory Default	230
32.7 no Command Examples	231
32.7.1 no mirror-port	231
32.7.2 no https timeout	231
32.7.3 no trunk	232
32.7.4 no port-access-authenticator	232
32.7.5 no ssh	233
32.8 interface Commands	234
32.8.1 interface port-channel	234
32.8.2 bpdu-control	234
32.8.3 broadcast-limit	235
32.8.4 bandwidth-limit	236
32.8.5 mirror	236
32.8.6 gvrp	237
32.8.7 ingress-check	238
32.8.8 frame-type	238
32.8.9 weight	239
32.8.10 egress set	239
32.8.11 qos priority	240
32.8.12 name	240
32.8.13 speed-duplex	241

Chapter 33	
IEEE 802.1Q Tagged VLAN Commands	243
33.1 IEEE 802.1Q Tagged VLAN Overview	243
33.2 VLAN Databases	243
33.2.1 Static Entries (SVLAN Table)	243
33.2.2 Dynamic Entries (DVLAN Table)	244
33.3 Configuring Tagged VLAN	244
33.4 Global VLAN1Q Tagged VLAN Configuration Commands	245
33.4.1 GARP Status	245
33.4.2 GARP Timer	245
33.4.3 GVRP Timer	246
33.4.4 Enable GVRP	246
33.4.5 Disable GVRP	247
33.5 Port VLAN Commands	247
33.5.1 Set Port VID	247
33.5.2 Set Acceptable Frame Type	247
33.5.3 Enable or Disable Port GVRP	248
33.5.4 Modify Static VLAN	248
33.5.4.1 Modify a Static VLAN Table Example	249
33.5.4.2 Forwarding Process Example	249
33.5.5 Delete VLAN ID	249
33.6 Enable VLAN	250
33.7 Disable VLAN	250
33.8 Show VLAN Setting	250
Chapter 34	
Troubleshooting	253
34.1 Problems Starting Up the Switch	253
34.2 Problems Accessing the Switch	253
34.2.1 Pop-up Windows, JavaScripts and Java Permissions	254
34.2.1.1 Internet Explorer Pop-up Blockers	254
34.2.1.2 JavaScripts	257
34.2.1.3 Java Permissions	259
34.3 Problems with the Password	261
Appendix A	
Product Specifications	263
Appendix B	
IP Subnetting	267
Index	275

List of Figures

Figure 1 Backbone Application	32
Figure 2 Bridging Application	32
Figure 3 High Performance Switched Application	33
Figure 4 Tag-based VLAN Application	34
Figure 5 Shared Server Using VLAN Example	34
Figure 6 Attaching Rubber Feet	35
Figure 7 Attaching the Mounting Brackets	36
Figure 8 Mounting the Switch on a Rack	37
Figure 9 Front Panel	39
Figure 10 Rear Panel	39
Figure 11 Transceiver Installation Example	41
Figure 12 Installed Transceiver	42
Figure 13 Opening the Transceiver's Latch Example	42
Figure 14 Transceiver Removal Example	42
Figure 15 Web Configurator: Login	46
Figure 16 Web Configurator Home Screen (Status)	46
Figure 17 Change Administrator Login Password	50
Figure 18 Example Xmodem Upload	51
Figure 19 Reload the Configuration file: Via Console Port	52
Figure 20 Resetting the Switch: Via the Console Port	53
Figure 21 Web Configurator: Logout Screen	53
Figure 22 Initial Setup Network Example: VLAN	55
Figure 23 Initial Setup Network Example: Port VID	57
Figure 24 Initial Setup Example: Management IP Address	58
Figure 25 Status	60
Figure 26 Status: Port Details	62
Figure 27 System Info	66
Figure 28 General Setup	68
Figure 29 Switch Setup	70
Figure 30 IP Setup	72
Figure 31 Port Setup	75
Figure 32 Port VLAN Trunking	79
Figure 33 Switch Setup: Select VLAN Type	80
Figure 34 VLAN: VLAN Status	80
Figure 35 VLAN: Static VLAN	82
Figure 36 VLAN: VLAN Port Setting	84

Figure 37 Port Based VLAN Setup (All Connected)	86
Figure 38 Port Based VLAN Setup (Port Isolation)	87
Figure 39 Static MAC Forwarding	89
Figure 40 Filtering	91
Figure 41 Spanning Tree Protocol: Status	95
Figure 42 Spanning Tree Protocol: Configuration	97
Figure 43 Bandwidth Control	100
Figure 44 Broadcast Storm Control	104
Figure 45 Mirroring	108
Figure 46 Link Aggregation Control Protocol Status	112
Figure 47 Link Aggregation: Configuration	114
Figure 48 RADIUS Server	117
Figure 49 Port Authentication	118
Figure 50 Port Authentication: RADIUS	118
Figure 51 Port Authentication: 802.1x	119
Figure 52 Port Security	122
Figure 53 Console Port Priority	125
Figure 54 Access Control	125
Figure 55 SNMP Management Model	126
Figure 56 Access Control: SNMP	128
Figure 57 Access Control: Logins	129
Figure 58 SSH Communication Example	130
Figure 59 How SSH Works	130
Figure 60 HTTPS Implementation	132
Figure 61 Security Alert Dialog Box (Internet Explorer)	133
Figure 62 Security Certificate 1 (Netscape)	133
Figure 63 Security Certificate 2 (Netscape)	134
Figure 64 Login Screen (Internet Explorer)	134
Figure 65 Login Screen (Netscape)	135
Figure 66 Access Control: Service Access Control	136
Figure 67 Access Control: Remote Management	137
Figure 68 Queuing Method	140
Figure 69 Classifier	144
Figure 70 Classifier: Summary Table	146
Figure 71 Classifier: Example	148
Figure 72 Policy	150
Figure 73 Policy: Summary Table	152
Figure 74 Policy Example	154
Figure 75 VLAN Stacking Example	156
Figure 76 VLAN Stacking	158
Figure 77 Multicast Setting	163
Figure 78 Multicast: IGMP Filtering Profile	165
Figure 79 MVR Network Example	166

Figure 80 MVR Multicast Television Example	167
Figure 81 MVR	168
Figure 82 MVR: Group Configuration	170
Figure 83 MVR Configuration Example	171
Figure 84 MVR Configuration Example	172
Figure 85 MVR Group Configuration Example	173
Figure 86 MVR Group Configuration Example	173
Figure 87 DHCP Relay	176
Figure 88 Static Routing	177
Figure 89 Maintenance	179
Figure 90 Firmware Upgrade	179
Figure 91 Restore Configuration	180
Figure 92 Backup Configuration	180
Figure 93 Load Factory Default: Conformation	181
Figure 94 Load Factory Default: Start	181
Figure 95 Reboot System: Confirmation	182
Figure 96 Reboot System: Start	182
Figure 97 Diagnostic	185
Figure 98 Clustering Application Example	187
Figure 99 Cluster Management: Status	188
Figure 100 Cluster Management: Cluster Member Web Configurator Screen	189
Figure 101 Example: Uploading Firmware to a Cluster Member Switch	190
Figure 102 Clustering Management Configuration	191
Figure 103 MAC Table Flowchart	193
Figure 104 MAC Table	194
Figure 105 ARP Table	196
Figure 106 Initial Console Port Screen	198
Figure 107 CLI: Login Screen	199
Figure 108 CLI Help: List of Commands: Example 1	200
Figure 109 CLI Help: List of Commands: Example 2	201
Figure 110 CLI Help: Detailed Command Information: Example 1	201
Figure 111 CLI: Help: Detailed Command Information: Example 2	201
Figure 112 CLI: History Command Example	202
Figure 113 CLI: write memory	203
Figure 114 show system-information Command Example	225
Figure 115 show ip Command Example	226
Figure 116 show logging Command Example	226
Figure 117 show interface Command Example	227
Figure 118 show mac address-table Command Example	228
Figure 119 ping Command Example	229
Figure 120 traceroute Command Example	229
Figure 121 Enable RSTP Command Example	230
Figure 122 CLI: boot config Command Example	230

Figure 123 CLI: reload config Command Example	230
Figure 124 CLI: Reset to the Factory Default Example	231
Figure 125 no mirror-port Command Example	231
Figure 126 no https timeout Command Example	232
Figure 127 no trunk Command Example	232
Figure 128 no port-access-authenticator Command Example	233
Figure 129 no ssh Command Example	234
Figure 130 interface Command Example	234
Figure 131 interface bpdu-control Command Example	235
Figure 132 broadcast-limit Command Example	236
Figure 133 bandwidth-limit Command Example	236
Figure 134 mirror Command Example	237
Figure 135 gvrp Command Example	238
Figure 136 ingress-check Command Example	238
Figure 137 frame-type Command Example	239
Figure 138 weight Command Example	239
Figure 139 egress set Command Example	240
Figure 140 qos priority Command Example	240
Figure 141 name Command Example	241
Figure 142 speed-duplex Command Example	241
Figure 143 Tagged VLAN Configuration and Activation Example	244
Figure 144 CPU VLAN Configuration and Activation Example	245
Figure 145 GARP STATUS Command Example	245
Figure 146 GARP Timer Command Example	246
Figure 147 GVRP Status Command Example	246
Figure 148 vlan1q port default vid Command Example	247
Figure 149 frame type Command Example	248
Figure 150 no gvrp Command Example	248
Figure 151 Modifying Static VLAN Example	249
Figure 152 no vlan Command Example	250
Figure 153 show vlan Command Example	251
Figure 154 Pop-up Blocker	255
Figure 155 Internet Options	255
Figure 156 Internet Options	256
Figure 157 Pop-up Blocker Settings	257
Figure 158 Internet Options	258
Figure 159 Security Settings - Java Scripting	259
Figure 160 Security Settings - Java	260
Figure 161 Java (Sun)	261

List of Tables

Table 1 Panel Connections	39
Table 2 Front Panel LEDs	43
Table 3 Navigation Panel Sub-links Overview	47
Table 4 Web Configurator Screen Sub-links Details	47
Table 5 Navigation Panel Links	48
Table 6 Status	60
Table 7 Status: Port Details	62
Table 8 System Info	66
Table 9 General Setup	68
Table 10 Switch Setup	70
Table 11 IP Setup	73
Table 12 Port Setup	75
Table 13 IEEE 802.1Q VLAN Terminology	78
Table 14 VLAN: VLAN Status	81
Table 15 VLAN: Static VLAN	83
Table 16 VLAN: VLAN Port Setting	85
Table 17 Port Based VLAN Setup	88
Table 18 Static MAC Forwarding	90
Table 19 Filtering	92
Table 20 STP Path Costs	93
Table 21 STP Port States	94
Table 22 Spanning Tree Protocol: Status	95
Table 23 Spanning Tree Protocol: Configuration	98
Table 24 Bandwidth Control	100
Table 25 Broadcast Storm Control	105
Table 26 Mirroring	109
Table 27 Link Aggregation ID: Local Switch	112
Table 28 Link Aggregation ID: Peer Switch	112
Table 29 Link Aggregation Control Protocol Status	113
Table 30 Link Aggregation Control Protocol: Configuration	115
Table 31 Port Authentication: RADIUS	118
Table 32 Port Authentication: 802.1x	120
Table 33 Port Security	123
Table 34 Access Control Overview	125
Table 35 SNMP Commands	126
Table 36 SNMP Traps	127

Table 37 Access Control: SNMP	128
Table 38 Access Control: Logins	129
Table 39 Access Control: Service Access Control	136
Table 40 Access Control: Remote Management	137
Table 41 Queuing Method	141
Table 42 Classifier	144
Table 43 Classifier: Summary Table	146
Table 44 Common Ethernet Types and Protocol Number	146
Table 45 Common IP Ports	147
Table 46 Policy	151
Table 47 Policy: Summary Table	153
Table 48 VLAN Tag Format	156
Table 49 Single and Double Tagged 802.11Q Frame Format	157
Table 50 802.1Q Frame	157
Table 51 VLAN Stacking	159
Table 52 Multicast Status	162
Table 53 Multicast Setting	164
Table 54 Multicast: IGMP Filtering Profile	165
Table 55 MVR	169
Table 56 MVR: Group Configuration	170
Table 57 DHCP Relay	176
Table 58 Static Routing	177
Table 59 Filename Conventions	182
Table 60 Diagnostic	185
Table 61 ZyXEL Clustering Management Specifications	187
Table 62 Cluster Management: Status	188
Table 63 FTP Upload to Cluster Member Example	190
Table 64 Clustering Management Configuration	191
Table 65 MAC Table	194
Table 66 ARP Table	196
Table 67 Command Summary: User Mode	203
Table 68 Command Summary: Enable Mode	204
Table 69 Command Summary: Configuration Mode	208
Table 70 interface port-channel Commands	218
Table 71 Command Summary: config-vlan Commands	221
Table 72 mvr Commands	223
Table 73 Troubleshooting the Start-Up of Your Switch	253
Table 74 Troubleshooting Accessing the Switch	253
Table 75 Troubleshooting the Password	261
Table 76 General Product Specifications	263
Table 77 Management Specifications	264
Table 78 Physical and Environmental Specifications	264
Table 79 Classes of IP Addresses	267

Table 80 Allowed IP Address Range By Class	268
Table 81 "Natural" Masks	268
Table 82 Alternative Subnet Mask Notation	269
Table 83 Two Subnets Example	269
Table 84 Subnet 1	270
Table 85 Subnet 2	270
Table 86 Subnet 1	271
Table 87 Subnet 2	271
Table 88 Subnet 3	271
Table 89 Subnet 4	272
Table 90 Eight Subnets	272
Table 91 Class C Subnet Planning	272
Table 92 Class B Subnet Planning	273

Preface

Congratulations on your purchase of the ES-3148 Intelligent Layer 2+ Switch.

This preface introduces you to the ES-3148 Intelligent Layer 2+ Switch and discusses the conventions of this User's Guide. It also provides information on other related documentation.

About This User's Guide

This manual is designed to guide you through the installation and configuration of your ES-3148 for its various applications.

Related Documentation

- Web Configurator Online Help

Embedded web help for descriptions of individual screens and supplementary information.









- ZyXEL Glossary and Web Site

Please refer to www.zyxel.com for an online glossary of networking terms and additional support documentation.

Syntax Conventions

- “Enter” means for you to type one or more characters. “Select” or “Choose” means for you to use one of the predefined choices.
- Command and arrow keys are enclosed in square brackets. [ENTER] means the Enter, or carriage return key; [ESC] means the Escape key and [SPACE BAR] means the Space Bar.
- Mouse action sequences are denoted using a comma. For example, “In Windows, click **Start**, **Settings** and then **Control Panel**” means first click the **Start** button, then point your mouse pointer to **Settings** and then click **Control Panel**.
- “e.g.,” is a shorthand for “for instance”, and “i.e.,” means “that is” or “in other words”.
- The ES-3148 Intelligent Layer 2+ Switch may be referred to as “the ES-3148” or “the switch” in this User's Guide.

Graphics Icons Key

ES-3148 	Computer 	Server 
Computer 	DSLAM 	Gateway 
Central Office/ ISP 	Internet 	Hub/Switch 

User Guide Feedback

Help us help you. E-mail all User Guide-related comments, questions or suggestions for improvement to techwriters@zyxel.com.tw or send regular mail to The Technical Writing Team, ZyXEL Communications Corp., 6 Innovation Road II, Science-Based Industrial Park, Hsinchu, 300, Taiwan. Thank you.

CHAPTER 1

Getting to Know Your Switch

This chapter introduces the main features and applications of the switch.

1.1 Introduction

The ES-3148 is a stand-alone layer 2 Ethernet switch with 48 10/100Mbps ports, two RJ-45 Gigabit (1Gbps or 1000Mbps)/mini-GBIC (Gigabit Interface Converter) combo ports for uplink, two RJ-45 Gigabit ports and a console port and a management port for local management. A combo port contains one Gigabit port and one slot for mini-GBIC transceiver (SFP module).

With its built-in web configurator, managing and configuring the switch is easy. In addition, the switch can also be managed via Telnet, any terminal emulator program on the console port, or third-party SNMP management.

1.2 Software Features

This section describes the general software features of the switch.

DHCP Client

DHCP (Dynamic Host Configuration Protocol RFC 2131 and RFC 2132) allows individual computers to obtain TCP/IP configuration at start-up from a server. You can configure the switch as a DHCP client to obtain TCP/IP information (such as the IP address and subnet mask) from a DHCP server. If you disable the DHCP service, you must manually enter the TCP/IP information.

VLAN

A VLAN (Virtual Local Area Network) allows a physical network to be partitioned into multiple logical networks. Devices on a logical network belong to one group. A device can belong to more than one group. With VLAN, a device cannot directly talk to or hear from devices that are not in the same group(s); the traffic must first go through a router.

Queuing

Queuing is used to help solve performance degradation when there is network congestion. Two scheduling services are supported: Strict Priority and Weighted Fair Scheduling. This allows the switch to maintain separate queues for packets from each individual source or flow and prevent a source from monopolizing the bandwidth.

Port Mirroring

Port mirroring allows you to copy traffic going from one or all ports to another or all ports in order that you can examine the traffic from the mirror port (the port you copy the traffic to) without interference.

Static Route

Static routes tell the switch how to forward IP traffic when you configure the TCP/IP parameters manually.

IGMP Snooping

The switch supports IGMP snooping enabling group multicast traffic to be only forwarded to ports that are members of that group; thus allowing you to significantly reduce multicast traffic passing through your switch.

Multicast VLAN Registration (MVR)

Multicast VLAN Registration (MVR) is designed for applications (such as Media-on-Demand (MoD)) using multicast traffic across a network. MVR allows one single multicast VLAN to be shared among different subscriber VLANs on the network.

This improves bandwidth utilization by reducing multicast traffic in the subscriber VLANs and simplifies multicast group management.

STP (Spanning Tree Protocol) / RSTP (Rapid STP)

(R)STP detects and breaks network loops and provides backup links between switches, bridges or routers. It allows a switch to interact with other (R)STP -compliant switches in your network to ensure that only one path exists between any two stations on the network.

Link Aggregation

Link aggregation (trunking) is the grouping of physical ports into one logical higher-capacity link. You may want to trunk ports if for example, it is cheaper to use multiple lower-speed links than to under-utilize a high-speed, but more costly, single-port link.

Port Authentication and Security

For security, the switch allows authentication using IEEE 802.1x with an external RADIUS server and port security that allows only packets with dynamically learned MAC addresses and/or configured static MAC addresses to pass through a port on the switch.

Cluster Management

Cluster Management allows you to manage switches through one switch, called the cluster manager. The switches must be directly connected and be in the same VLAN group so as to be able to communicate with one another using same cluster management implementation.

Maintenance and Management Features

- Access Control
You can specify the service(s) and computer IP address(es) to control access to the switch for management.
- Cluster Management
Cluster management (also known as iStacking) allows you to manage switches through one switch, called the cluster manager. The switches must be directly connected and be in the same VLAN group so as to be able to communicate with one another.
- Configuration and Firmware Maintenance
You can backup or restore the switch configuration or upgrade the firmware on the switch.

IP Protocols

- IP Host (No routing)
- Telnet for configuration and monitoring
- SNMP for management
 - SNMP MIB II (RFC 1213)
 - SNMP v1 RFC 1157
 - SNMPv2, SNMPv2c or later version, compliant with RFC 2011
SNMPv2 MIB for IP, RFC 2012 SNMPv2 MIB for TCP, RFC 2013
SNMPv2 MIB for UDP
 - Ethernet MIBs RFC 1643
 - Bridge MIBs RFC 1493
 - SMI RFC 1155
 - RMON RFC 1757
 - SNMPv2, SNMPv2c RFC 2674

System Monitoring

- System status (link status, rates, statistics counters)
- SNMP
- Temperatures, voltage, fan speed reports and alarms
- Port Mirroring allows you to analyze one port's traffic from another.

Security

- System management password protection

- Port-based VLAN
- IEEE 802.1Q VLAN
- 802.1x Authentication
- Limit dynamic port MAC address learning
- Static MAC address filtering

Bandwidth Control

- The ES-3148 supports rate limiting in 1Mbps increments allowing you to create different service plans.
- The ES-3148 supports IGMP snooping enabling group multicast traffic to be only forwarded to ports that are members of that group; thus allowing you to significantly reduce multicast traffic passing through your switch.
- Broadcast storm control

Quality of Service

- Eight queues so you can ensure mission-critical data gets delivered on time.
- Follows the IEEE 802.1p priority setting standard based on source/destination MAC addresses.

1.3 Hardware Features

This section describes the hardware features of the ES-3148.

Power

The ES-3148 requires 100~240VAC/1.5A power.

48 10/100 Mbps Fast Ethernet Ports

Connect up to 48 computers or switches to the 10/100Mbps auto-negotiating, automatic cable sensing (auto-MDIX) Ethernet RJ-45 ports. All Ethernet ports support:

- IEEE 802.3u/3z/3ab standards
- Back pressure flow control in half duplex mode
- IEEE 802.3x flow control in full duplex mode

Two Gigabit Ethernet Ports for Uplink Modules

The gigabit ports allow the ES-3148 to connect to another WAN switch or daisy-chain to other switches.

Two Slots for Mini-GBIC Modules

The mini-GBIC (Gigabit Interface Converter) module transceivers allow flexibility in connection options. You can use mini-GBIC transceivers for fiber connections to backbone Ethernet switches.

iStacking

Up to 24 switches may be stacked.

Console Port

Use the console port for local management of the switch.

Fans

The fans cool the switch sufficiently to allow reliable operation of the switch in even poorly ventilated rooms or basements.

1.4 Applications

This section shows a few examples of using the switch in various network environments.

1.4.1 Backbone Application

In this application, the switch is an ideal solution for small networks where rapid growth can be expected in the near future.

The switch can be used standalone for a group of heavy traffic users. You can connect computers directly to the switch's port or connect other switches to the switch.

In this example, all computers can share high-speed applications on the server. To expand the network, simply add more networking devices such as switches, routers, computers, print servers etc.

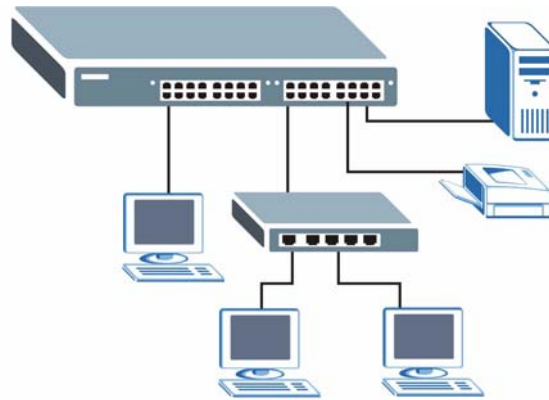
Figure 1 Backbone Application

1.4.2 Bridging Example

In this example application the switch connects different company departments (**RD** and **Sales**) to the corporate backbone. It can alleviate bandwidth contention and eliminate server and network bottlenecks. All users that need high bandwidth can connect to high-speed department servers via the switch. You can provide a super-fast uplink connection by using a Gigabit Ethernet/mini-GBIC port on the switch.

Moreover, the switch eases supervision and maintenance by allowing network managers to centralize multiple servers at a single location.

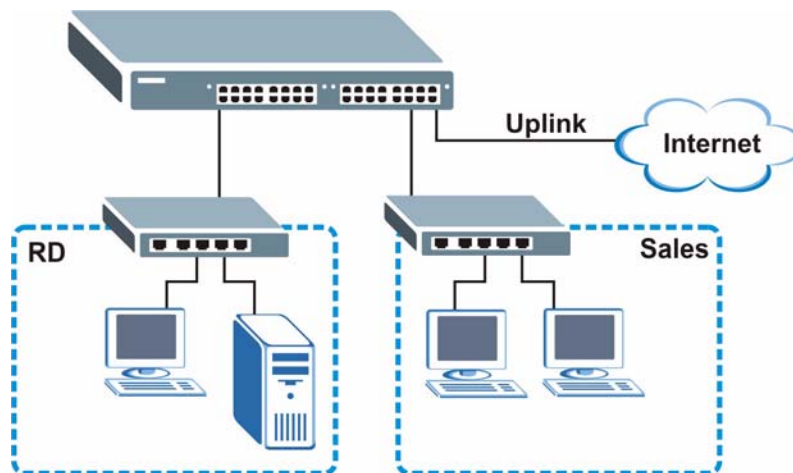
Figure 2 Bridging Application

1.4.3 High Performance Switched Example

The switch is ideal for connecting two networks that need high bandwidth. In the following example, use trunking to connect these two networks.

Switching to higher-speed LANs such as ATM (Asynchronous Transmission Mode) is not feasible for most people due to the expense of replacing all existing Ethernet cables and adapter cards, restructuring your network and complex maintenance. The switch can provide the same bandwidth as ATM at much lower cost while still being able to use existing adapters and switches. Moreover, the current LAN structure can be retained as all ports can freely communicate with each other.

Figure 3 High Performance Switched Application

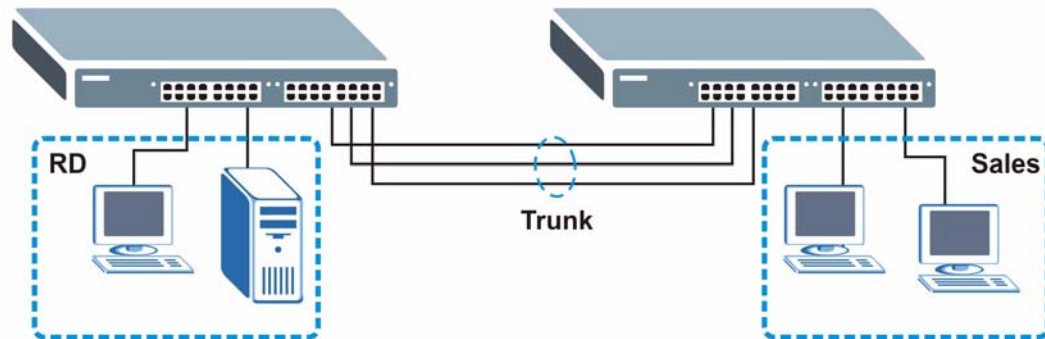

1.4.4 IEEE 802.1Q VLAN Application Examples

This section shows a workgroup and a shared server example using 802.1Q tagged VLANs.

A VLAN (Virtual Local Area Network) allows a physical network to be partitioned into multiple logical networks. Stations on a logical network belong to one group. A station can belong to more than one group. With VLAN, a station cannot directly talk to or hear from stations that are not in the same group(s) unless such traffic first goes through a router.

For more information on VLANs, refer to [Chapter 8 on page 77](#).

1.4.4.1 Tag-based VLAN Example

Ports in the same VLAN group share the same frame broadcast domain thus increase network performance through reduced broadcast traffic. VLAN groups can be modified at any time by adding, moving or changing ports without any re-cabling.

Figure 4 Tag-based VLAN Application

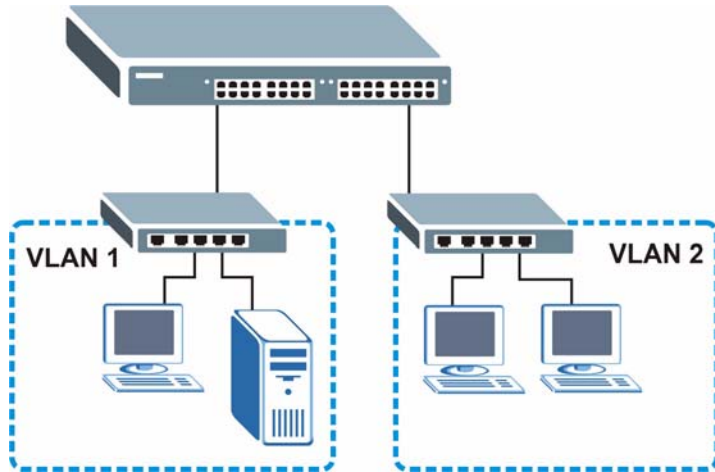

1.4.4.2 VLAN Shared Server Example

Shared resources such as a server can be used by all ports in the same VLAN as the server, as shown in the following example. In this example, only ports that need access to the server need belong to VLAN 1. Ports can belong to other VLAN groups too.

Figure 5 Shared Server Using VLAN Example

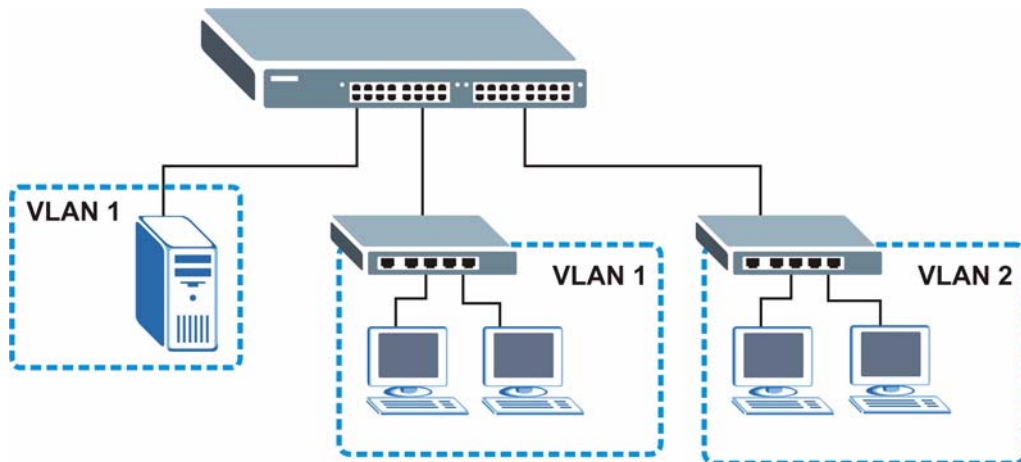

CHAPTER 2

Hardware Installation and Connection

This chapter shows you how to install and connect the switch.

2.1 Freestanding Installation

- 1 Make sure the switch is clean and dry.
- 2 Set the switch on a smooth, level surface strong enough to support the weight of the switch and the connected cables. Make sure there is a power outlet nearby.
- 3 Make sure there is enough clearance around the switch to allow air circulation and the attachment of cables and the power cord.
- 4 Remove the adhesive backing from the rubber feet.
- 5 Attach the rubber feet to each corner on the bottom of the switch. These rubber feet help protect the switch from shock or vibration and ensure space between devices when stacking.

Figure 6 Attaching Rubber Feet

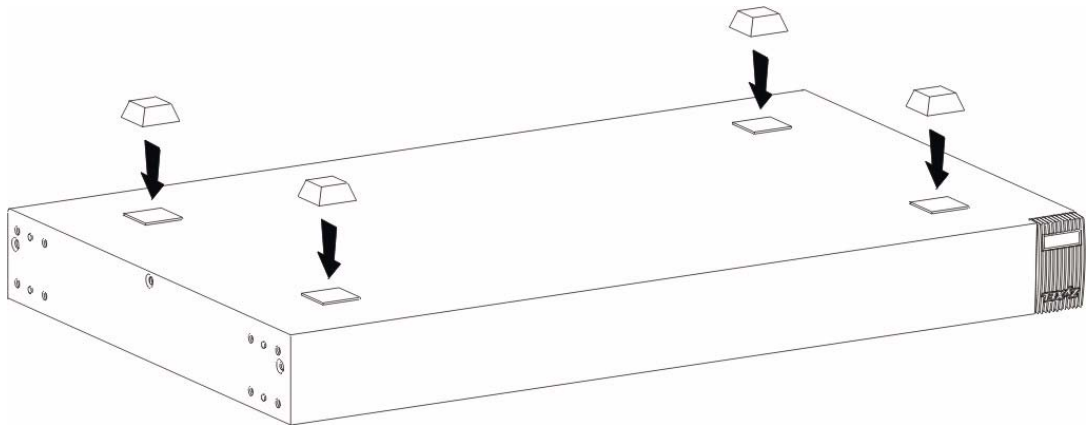

Note: Do NOT block the ventilation holes. Leave space between devices when stacking.

For proper ventilation, allow at least 4 inches (10 cm) of clearance at the front and 3.4 inches (8 cm) at the back of the switch. This is especially important for enclosed rack installations.

2.2 Mounting the Switch on a Rack

This section lists the rack mounting requirements and precautions and describes the installation steps.

2.2.1 Rack-mounted Installation Requirements

- Two mounting brackets.
- Eight M3 flat head screws and a #2 Philips screwdriver.
- Four M5 flat head screws and a #2 Philips screwdriver.

Note: Failure to use the proper screws may damage the unit.

2.2.1.1 Precautions

- Make sure the rack will safely support the combined weight of all the equipment it contains.
- Make sure the position of the switch does not make the rack unstable or top-heavy. Take all necessary precautions to anchor the rack securely before installing the unit.

2.2.2 Attaching the Mounting Brackets to the Switch

- 1 Position a mounting bracket on one side of the switch, lining up the four screw holes on the bracket with the screw holes on the side of the switch.

Figure 7 Attaching the Mounting Brackets

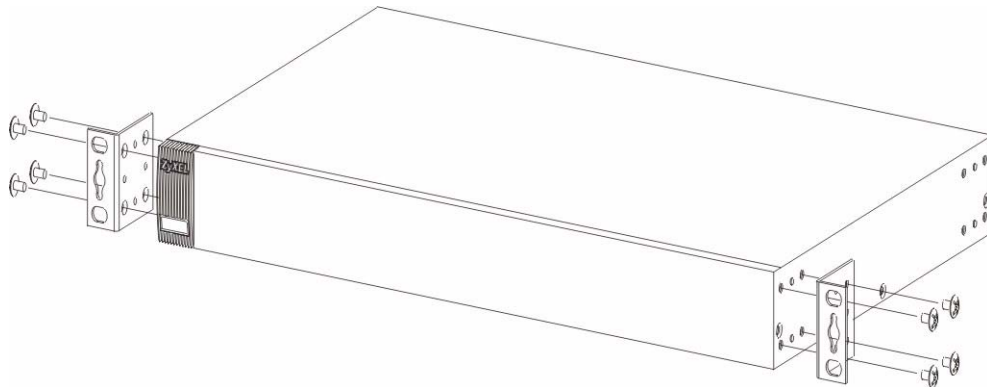

- 2 Using a #2 Philips screwdriver, install the M3 flat head screws through the mounting bracket holes into the switch.
- 3 Repeat steps 1 and 2 to install the second mounting bracket on the other side of the switch.
- 4 You may now mount the switch on a rack. Proceed to the next section.

2.2.3 Mounting the Switch on a Rack

- 1 Position a mounting bracket (that is already attached to the switch) on one side of the rack, lining up the two screw holes on the bracket with the screw holes on the side of the rack.

Figure 8 Mounting the Switch on a Rack

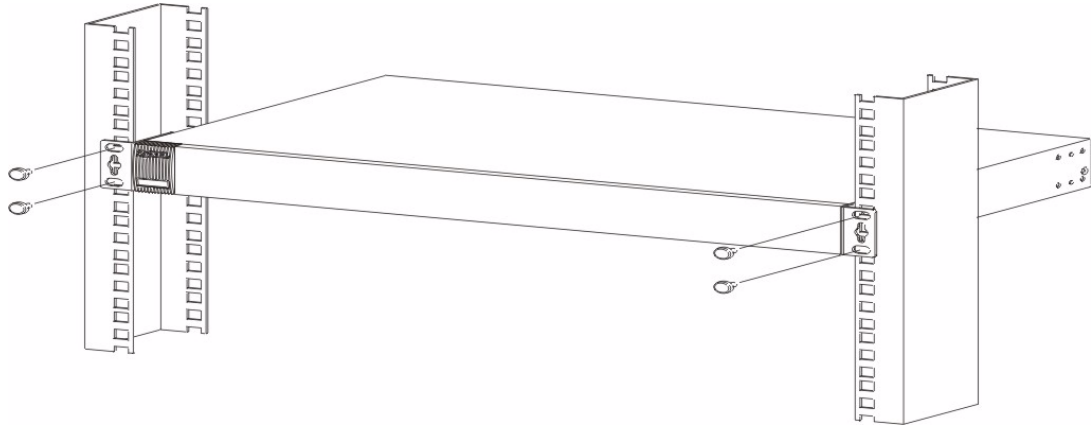

- 2 Using a #2 Philips screwdriver, install the M5 flat head screws through the mounting bracket holes into the rack.
- 3 Repeat steps 1 and 2 to attach the second mounting bracket on the other side of the rack.

CHAPTER 3

Hardware Overview

This chapter describes the front panel and rear panel of the switch and shows you how to make the hardware connections.

3.1 Panel Connections

The figures below show the front panel and the rear panel of the switch.

Figure 9 Front Panel

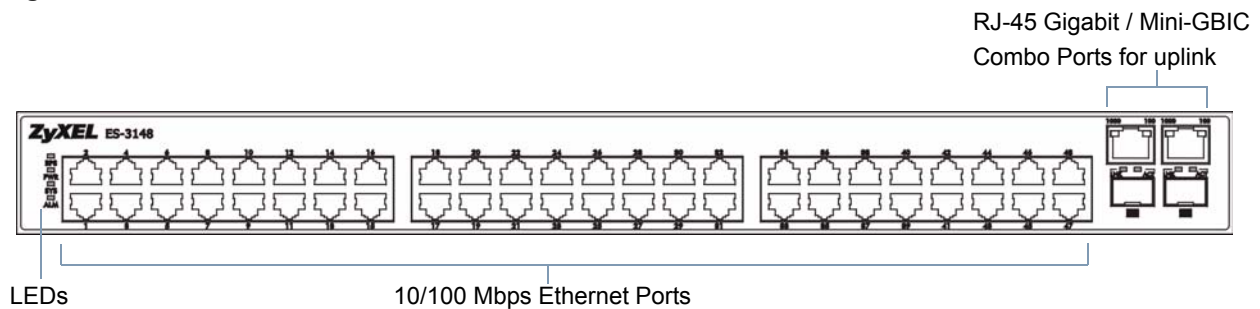
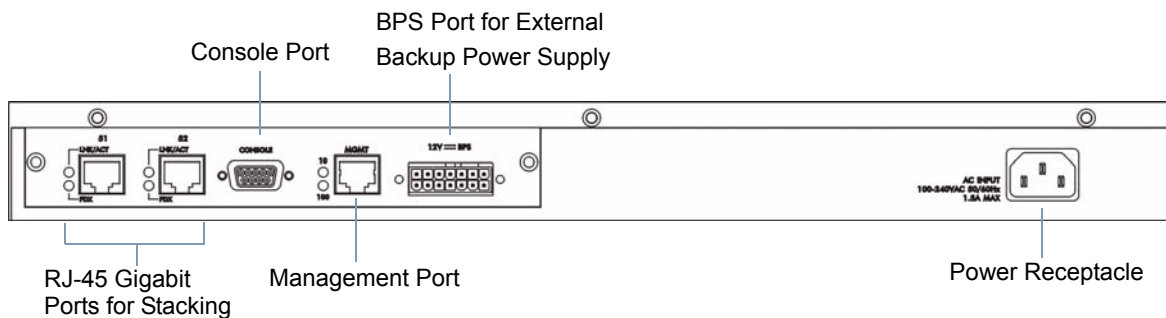

Figure 10 Rear Panel



The following table describes the ports on the panels.

Table 1 Panel Connections

CONNECTOR	DESCRIPTION
48 10/100 Mbps RJ-45 Ethernet Ports	Connect these ports to a computer, a hub, an Ethernet switch or router.
Four 100/1000 Mbps RJ-45 Gigabit Ports	Connect these Gigabit Ethernet ports to high-bandwidth backbone network Ethernet switches or use them to daisy-chain other switches.

Table 1 Panel Connections (continued)

CONNECTOR	DESCRIPTION
Mini-GBIC Ports	Use mini-GBIC transceivers in these slots for fiber-optical connections to backbone Ethernet switches.
Console Port	Only connect this port if you want to configure the switch using the command line interface (CLI) via the console port.
Management Port	Connect to a computer using an RJ-45 Ethernet cable for local configuration of the switch.

3.1.1 Console Port

For local management, you can use a computer with terminal emulation software configured to the following parameters:

- VT100 terminal emulation
- 9600 bps
- No parity, 8 data bits, 1 stop bit
- No flow control

Connect the male 9-pin end of the console cable to the console port of the switch. Connect the female end to a serial port (COM1, COM2 or other COM port) of your computer.

3.1.2 Ethernet Ports

The switch has 24 100/1000Mbps auto-negotiating, auto-crossover Ethernet ports. In 100/1000Mbps Fast Ethernet, the speed can be 100Mbps or 1000Mbps and the duplex mode can be half duplex or full duplex.

There are two pairs of Gigabit Ethernet/mini-GBIC ports. The mini-GBIC ports have priority over the Gigabit ports. This means that if a mini-GBIC port and the corresponding Gigabit port are connected at the same time, the Gigabit port will be disabled. The speed of the Gigabit Ethernet/mini-GBIC ports can be 100Mbps or 1000Mbps and the duplex mode can be half duplex (at 100 Mbps) or full duplex.

An auto-negotiating port can detect and adjust to the optimum Ethernet speed (100/1000Mbps) and duplex mode (full duplex or half duplex) of the connected device.

An auto-crossover (auto-MDI/MDI-X) port automatically works with a straight-through or crossover Ethernet cable.

3.1.2.1 Default Ethernet Settings

The factory default negotiation settings for the Ethernet ports on the switch are:

- Speed: Auto
- Duplex: Auto

- Flow control: Off

3.1.3 Mini-GBIC Slots

These are slots for mini-GBIC (Gigabit Interface Converter) transceivers. A transceiver is a single unit that houses a transmitter and a receiver. The switch does not come with transceivers. You must use transceivers that comply with the SFP Transceiver MultiSource Agreement (MSA). See the SFF committee's INF-8074i specification Rev 1.0 for details.

There are two pairs of Gigabit Ethernet/mini-GBIC ports. The mini-GBIC ports have priority over the Gigabit ports. This means that if a mini-GBIC port and the corresponding Gigabit port are connected at the same time, the Gigabit port will be disabled.

You can change transceivers while the switch is operating. You can use different transceivers to connect to Ethernet switches with different types of fiber-optic connectors.

- Type: SFP connection interface
- Connection speed: 1 Gigabit per second (Gbps)

Note: To avoid possible eye injury, do not look into an operating fiber-optic module's connectors.

3.1.3.1 Transceiver Installation

Use the following steps to install a mini GBIC transceiver (SFP module).

- 1 Insert the transceiver into the slot with the exposed section of PCB board facing down.

Figure 11 Transceiver Installation Example

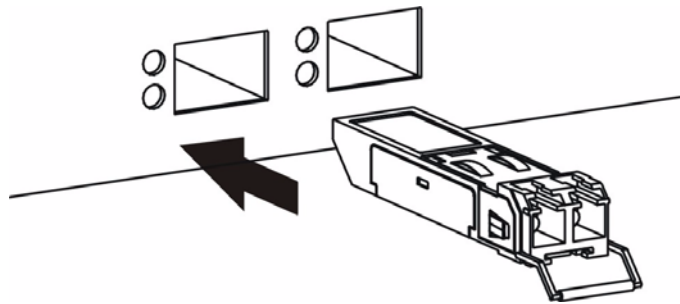

- 2 Press the transceiver firmly until it clicks into place.
- 3 The switch automatically detects the installed transceiver. Check the LEDs to verify that it is functioning properly.

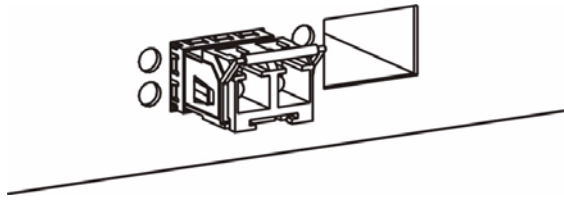
Figure 12 Installed Transceiver

3.1.3.2 Transceiver Removal

Use the following steps to remove a mini GBIC transceiver (SFP module).

- 1 Open the transceiver's latch (latch styles vary).

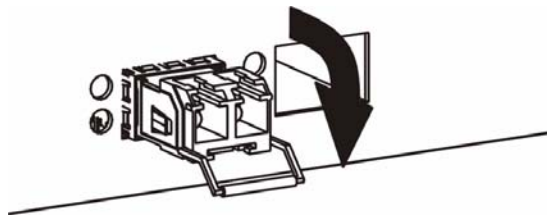
Figure 13 Opening the Transceiver's Latch Example

- 2 Pull the transceiver out of the slot.

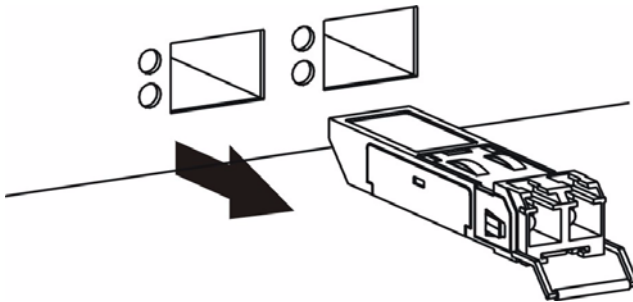
Figure 14 Transceiver Removal Example

3.1.4 Power Connector

Make sure you are using the correct power source as shown on the panel.

To connect the power to the switch, insert the female end of power cord to the power receptacle on the rear panel. Connect the other end of the supplied power cord to the power source. Make sure that no objects obstruct the airflow of the fans.

3.1.5 External Backup Power Supply Connector

The switch supports external backup power supply (BPS).

The backup power supply constantly monitors the status of the internal power supply. The backup power supply automatically provides power to the switch in the event of a power failure. Once the switch receives power from the backup power supply, it will not automatically switch back to using the internal power supply even when the power is resumed.

3.2 Panel LEDs

The following table describes the LEDs on the panels.

Table 2 Front Panel LEDs

LED	COLOR	STATUS	DESCRIPTION
BPS	Green	Blinking	The system is receiving power from the backup power supply.
		On	The backup power supply is connected and active.
		Off	The backup power supply is not ready or not active.
PWR	Green	On	The system is turned on.
		Off	The system is off.
SYS	Green	Blinking	The system is rebooting and performing self-diagnostic tests.
		On	The system is on and functioning properly.
		Off	The power is off or the system is not ready/malfunctioning.
ALM	Red	On	There is a hardware failure.
		Off	The system is functioning normally.
10	Green	Blinking	The system is transmitting/receiving to/from an Ethernet device.
		On	The port is connected at 10Mbps.
		Off	The port is not connected at 10Mbps or to an Ethernet device.
100	Amber	Blinking	The system is transmitting/receiving to/from an Ethernet device.
		On	The port is connected at 100Mbps.
		Off	The port is not connected at 100Mbps or to an Ethernet device.
Uplink Gigabit Port			
1000	Green	Blinking	The system is transmitting/receiving to/from an Ethernet device.
		On	The port is connected at 1000Mbps.
		Off	The port is not connected at 1000Mbps or to an Ethernet device.
100	Amber	Blinking	The system is transmitting/receiving to/from an Ethernet device.
		On	The port is connected at 100Mbps.
		Off	The port is not connected at 100Mbps or to an Ethernet device.
GBIC Slots			
LNK	Green	On	The port has a successful connection.
		Off	No Ethernet device is connected to this port.
ACT	Green	Blinking	The port is receiving or transmitting data.
Gigabit Port			

Table 2 Front Panel LEDs (continued)

LED	COLOR	STATUS	DESCRIPTION
LNK/ACT	Green	Blinking	The system is transmitting/receiving to/from a 1000 Mbps Ethernet network.
		On	The link to a 1000 Mbps Ethernet network is up.
	Amber	Blinking	The system is transmitting/receiving to/from a 100 Mbps Ethernet network.
		On	The link to a 100 Mbps Ethernet network is up.
		Off	The link to an Ethernet network is down.
	FDX	Amber	On
Off			The Gigabit port is negotiating in half-duplex mode and no collisions are occurring.
MGMT			
10	Green	Blinking	The system is transmitting/receiving to/from an Ethernet device.
		On	The port is connected at 10 Mbps.
		Off	The port is not connected at 10 Mbps or to an Ethernet device.
100	Amber	Blinking	The system is transmitting/receiving to/from an Ethernet device.
		On	The port is connected at 100 Mbps.
		Off	The port is not connected at 100 Mbps or to an Ethernet device.

CHAPTER 4

The Web Configurator

This section introduces the configuration and functions of the web configurator.

4.1 Introduction

The web configurator is an HTML-based management interface that allows easy switch setup and management via Internet browser. Use Internet Explorer 6.0 and later or Netscape Navigator 7.0 and later versions. The recommended screen resolution is 1024 by 768 pixels.

In order to use the web configurator you need to allow:

- Web browser pop-up windows from your device. Web pop-up blocking is enabled by default in Windows XP SP (Service Pack) 2.
- JavaScript (enabled by default).
- Java permissions (enabled by default).

4.2 System Login

- 1 Start your web browser.
- 2 Type “http://” and the IP address of the switch (for example, the default for the management port is 192.168.0.1 and for the switch port is 192.168.1.1) in the **Location** or **Address** field. Press [ENTER].
- 3 The login screen appears. The default username is **admin** and associated default password is **1234**. The date and time display as shown if you have not configured a time server nor manually entered a time and date in the **General Setup** screen.

Figure 15 Web Configurator: Login



4 Click **OK** to view the first web configurator screen.

4.3 The Status Screen

The **Status** screen is the first screen that displays when you access the web configurator.



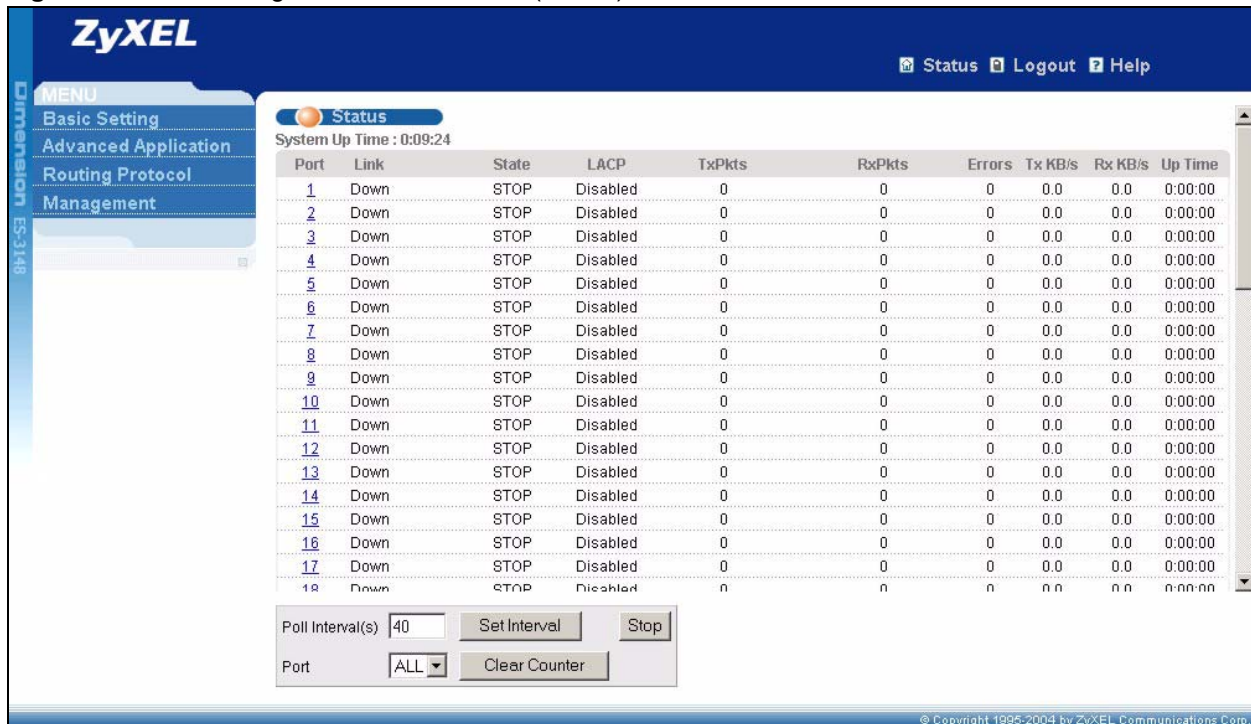

The following figure shows the navigating components of a web configurator screen.

Figure 16 Web Configurator Home Screen (Status)

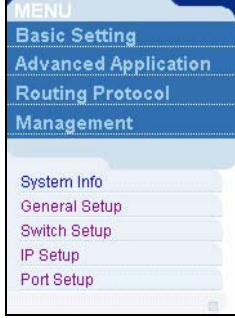

In the navigation panel, click a main link to reveal a list of submenu links.

Table 3 Navigation Panel Sub-links Overview

BASIC SETTING	ADVANCED APPLICATION	ROUTING PROTOCOL	MANAGEMENT
			

The following table lists the various web configurator screens within the sub-links.

Table 4 Web Configurator Screen Sub-links Details

BASIC SETTING	ADVANCED APPLICATION	ROUTING PROTOCOL	MANAGEMENT
System Info General Setup Switch Setup IP Setup Port Setup	VLAN VLAN Status VLAN Port Setting Static VLAN Static MAC Forwarding Filtering Spanning Tree Protocol Status Configuration Bandwidth Control Broadcast Storm Control Mirroring	Static Routing	Maintenance Firmware Upgrade Restore Configuration Backup Configuration Load Factory Default Reboot System Diagnostic Cluster Management Status Configuration MAC Table ARP Table

Table 4 Web Configurator Screen Sub-links Details (continued)

BASIC SETTING	ADVANCED APPLICATION	ROUTING PROTOCOL	MANAGEMENT
	Link Aggregation Status Configuration Port Authentication RADIUS 802.1x Port Security Access Control SNMP Logins Service Access Control Remote Management Queuing Method Classifier Policy Rule VLAN Stacking Multicast Multicast Status Multicast Setting IGMP Filtering Profile MVR DHCP Relay		

The following table describes the links in the navigation panel.

Table 5 Navigation Panel Links

LINK	DESCRIPTION
Basic Settings	
System Info	This link takes you to a screen that displays general system and hardware monitoring information.
General Setup	This link takes you to a screen where you can configure general identification information about the switch.
Switch Setup	This link takes you to a screen where you can set up global switch parameters such as VLAN type, MAC address learning, GARP and priority queues.
IP Setup	This link takes you to a screen where you can configure the management IP address, subnet mask (necessary for switch management) and DNS (domain name server).
Port Setup	This link takes you to screens where you can configure settings for individual switch ports.
Advanced Application	

Table 5 Navigation Panel Links (continued)

LINK	DESCRIPTION
VLAN	This link takes you to screens where you can configure port-based or 802.1Q VLAN (depending on what you configured in the Switch Setup menu).
Static MAC Forwarding	This link takes you to screens where you can configure static MAC addresses for a port. These static MAC addresses do not age out.
Filtering	This link takes you to a screen to set up filtering rules.
Spanning Tree Protocol	This link takes you to screens where you can configure the STP/RSTP to prevent network loops.
Bandwidth Control	This link takes you to screens where you can cap the maximum incoming bandwidth allowed on specified port(s).
Broadcast Storm Control	This link takes you to a screen to set up broadcast filters.
Mirroring	This link takes you to screens where you can copy traffic from one port or ports to another port in order that you can examine the traffic from the first port without interference
Link Aggregation	This link takes you to a screen where you can logically aggregate physical links to form one logical, higher-bandwidth link.
Port Authentication	This link takes you to a screen where you can configure RADIUS (Remote Authentication Dial-In User Service), a protocol for user authentication that allows you to use an external server to validate an unlimited number of users.
Port Security	This link takes you to a screen where you can activate maximum port security through the use of configured static MAC addresses.
Access Control	This link takes you to screens where you can change the system login password and configure SNMP and remote management.
Queuing Method	This link takes you to a screen where you can configure strictly priority or weighted fair scheduling with associated queue weights for each port.
Classifier	This link takes you to a screen where you can configure classifiers.
Policy Rule	This link takes you to a screen where you can configure policy rules.
VLAN Stacking	This link takes you to a screen where you can configure VLAN stacking.
Multicast	This link takes you to a screen where you can configure various multicast features and create multicast VLANs.
DHCP Relay	This link takes you to a screen where you can configure DHCP relay information and specify the DHCP server(s).
Routing Protocol	
Static Routing	This link takes you to screens where you can configure static routes. A static route defines how the switch should forward traffic by configuring the TCP/IP parameters manually.
Management	
Maintenance	This link takes you to screens where you can perform firmware and configuration file maintenance as well as reboot the system.
Diagnostic	This link takes you to screens where you can view system logs and test port(s).
Cluster Management	This link takes you to a screen where you can configure clustering management and view its status.
MAC Table	This link takes you to a screen where you can view the MAC addresses (and types) of devices attached to what ports and VLAN IDs.
ARP Table	This link takes you to a screen where you can view the MAC addresses – IP address resolution table.

4.3.1 Change Your Password

After you log in for the first time, it is recommended you change the default administrator password. Click **Advanced Application**, **Access Control** and then **Logins** to display the next screen.

Figure 17 Change Administrator Login Password

The screenshot shows the 'Logins' page under 'Access Control'. The 'Administrator' section has three input fields: 'Old Password', 'New Password', and 'Retype to confirm'. A red circle highlights these fields. Below them is a warning: 'Please record your new password whenever you change it. The system will lock you out if you have forgotten your password.' Underneath is an 'Edit Logins' table with four columns: 'Login', 'User Name', 'Password', and 'Retype to confirm'. The table has four rows, each with a 'Login' number (1-4) and empty input fields for the other three columns. At the bottom are 'Apply' and 'Cancel' buttons.

Old Password	New Password	Retype to confirm
<input type="text"/>	<input type="text"/>	<input type="text"/>

Please record your new password whenever you change it. The system will lock you out if you have forgotten your password.

Login	User Name	Password	Retype to confirm
1	<input type="text"/>	<input type="text"/>	<input type="text"/>
2	<input type="text"/>	<input type="text"/>	<input type="text"/>
3	<input type="text"/>	<input type="text"/>	<input type="text"/>
4	<input type="text"/>	<input type="text"/>	<input type="text"/>

Apply Cancel

4.4 Switch Lockout

You could block yourself (and all others) from accessing the switch through the web configurator if you do one of the following:

- 1 Deleting the management VLAN (default is VLAN 1).
- 2 Deleting all port-based VLANs with the CPU port as a member. The “CPU port” is the management port of the switch.
- 3 Filtering all traffic to the CPU port.
- 4 Disabling all ports.
- 5 Misconfiguring the text configuration file.
- 6 Forgetting the password and/or IP address.
- 7 Preventing all services from accessing the switch.
- 8 Changing a service port number but forgetting it.

Note: Be careful not to lock yourself and others out of the switch.

4.5 Resetting the Switch

If you lock yourself (and others) from the switch or forget the switch password, you will need to reload the factory-default configuration file or reset the switch back to the factory defaults.

4.5.1 Reload the Configuration File

Uploading the factory-default configuration file replaces the current configuration file with the factory-default configuration file. This means that you will lose all previous configurations and the speed of the console port will be reset to the default of 9600bps with 8 data bit, no parity, one stop bit and flow control set to none. The password will also be reset to “1234” and the IP address to 192.168.1.1.

To upload the configuration file, do the following:

- 1 Connect to the console port using a computer with terminal emulation software. See [Section 3.1.1 on page 40](#) for details.
- 2 Disconnect and reconnect the switch's power to begin a session. When you reconnect the switch's power, you will see the initial screen.
- 3 When you see the message “Press any key to enter Debug Mode within 3 seconds ...” press any key to enter debug mode.
- 4 Type `atlc` after the “Enter Debug Mode” message.
- 5 Wait for the “Starting XMODEM upload” message before activating XMODEM upload on your terminal.
- 6 This is an example Xmodem configuration upload using HyperTerminal. Click **Transfer**, then **Send File** to display the following screen.

Figure 18 Example Xmodem Upload

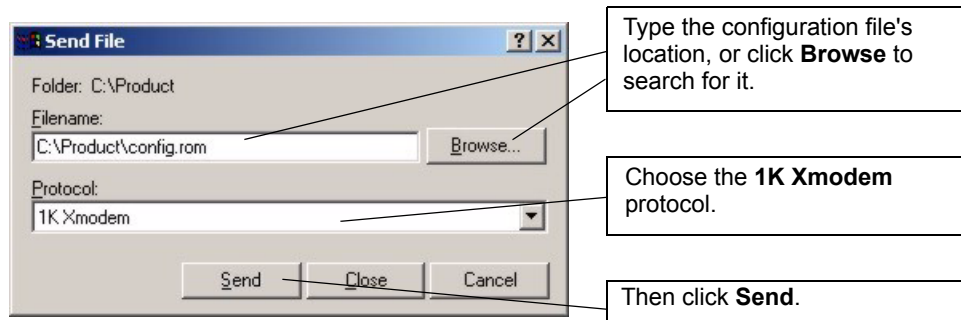

- 7 After a configuration file upload, type `atgo` to restart the switch.

Figure 19 Reload the Configuration file: Via Console Port

```
Bootbase Version: V0.6 | 05/02/2005 16:32:24
RAM:Size = 32 Mbytes
DRAM POST: Testing: 32768K OK
DRAM Test SUCCESS !
FLASH: Intel 32M

ZyNOS Version: V3.60(TZ.0)b0.1 | 05/24/2005 10:28:06

Press any key to enter debug mode within 3 seconds.
.....
Enter Debug Mode

ES-3148> atlc
Starting XMODEM upload (CRC mode)....
CCCCCCCCCCCCCCCC
Total 262144 bytes received.
Erasing..
.....
OK
ES-3148> atgo
```

The switch is now reinitialized with a default configuration file including the default password of "1234".

4.5.2 Reset to the Factory Defaults

To reset the switch back to the factory defaults, do the following:

- 1** Connect to the console port using a computer with terminal emulation software. See the chapter on hardware connections for details.
- 2** Disconnect and reconnect the switch's power to begin a session. When you reconnect the switch's power, you will see the initial screen.
- 3** When you see the message "Press any key to enter Debug Mode within 3 seconds" press any key to enter debug mode.
- 4** Type `atbr` after the "Enter Debug Mode" message.

Figure 20 Resetting the Switch: Via the Console Port

```

Bootbase Version: V0.6 | 05/02/2005 16:32:24
RAM:Size = 32 Mbytes
DRAM POST: Testing: 32768K OK
DRAM Test SUCCESS !
FLASH: Intel 32M

ZyNOS Version: V3.60(TZ.0)b0.1 | 05/24/2005 10:28:06

Press any key to enter debug mode within 3 seconds.
.....
Enter Debug Mode

ES-3148> atbr
Restore default
Romfile.....
.....OK
ES-3148> atgo

```

5 After the resetting, type `atgo` to restart the switch.

4.6 Logging Out of the Web Configurator

Click **Logout** in a screen to exit the web configurator. You have to log in with your password again after you log out. This is recommended after you finish a management session both for security reasons and so as you don't lock out other switch administrators.

Figure 21 Web Configurator: Logout Screen

4.7 Help

The web configurator's online help has descriptions of individual screens and some supplementary information.

Click the **Help** link from a web configurator screen to view an online help description of that screen.

CHAPTER 5

Initial Setup Example

This chapter shows how to set up the switch for an example network.

5.1 Overview

The following lists the configuration steps for the initial setup:

- Create a VLAN
- Set port VLAN ID
- Configure the switch IP management address

5.1.1 Creating a VLAN

VLANs confine broadcast frames to the VLAN group in which the port(s) belongs. You can do this with port-based VLAN or tagged static VLAN with fixed port members.

In this example, you want to configure port 10 as a member of VLAN 2.

Figure 22 Initial Setup Network Example: VLAN

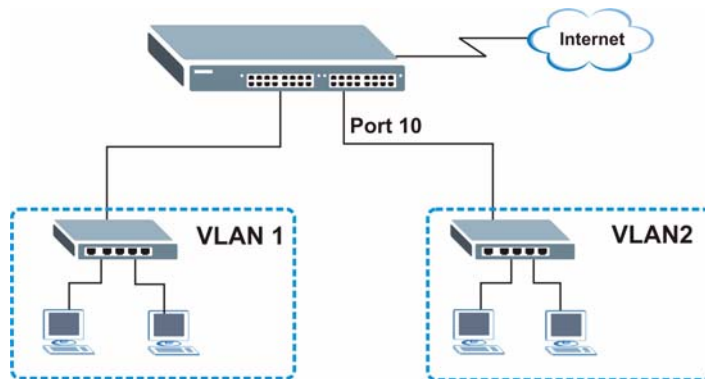

- 1 Click **Advanced Application** and **VLAN** in the navigation panel and click the **Static VLAN** link.

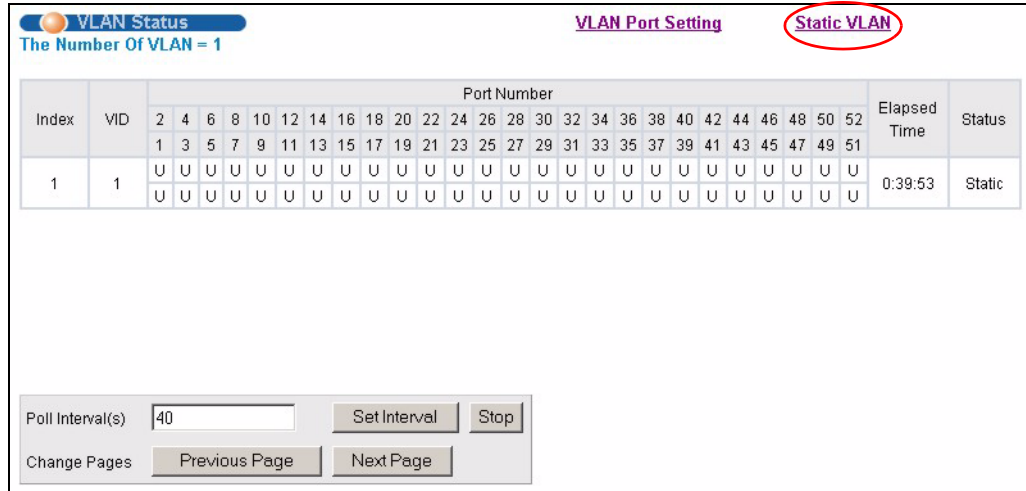

- 2 In the **Static VLAN** screen, select **ACTIVE**, enter a descriptive name in the **Name** field and enter 2 in the **VLAN Group ID** field for the **VLAN2** network.

Note: The **VLAN Group ID** field in this screen and the **VID** field in the **IP Setup** screen refer to the same VLAN ID.

- 3 Since the **VLAN2** network is connected to port 10 on the switch, select **Fixed** to configure port 10 to be a permanent member of the VLAN only.
- 4 To ensure that VLAN-unaware devices (such as computers and hubs) can receive frames properly, clear the **TX Tagging** check box to set the switch to remove VLAN tags before sending.
- 5 Click **Add** to save the settings.

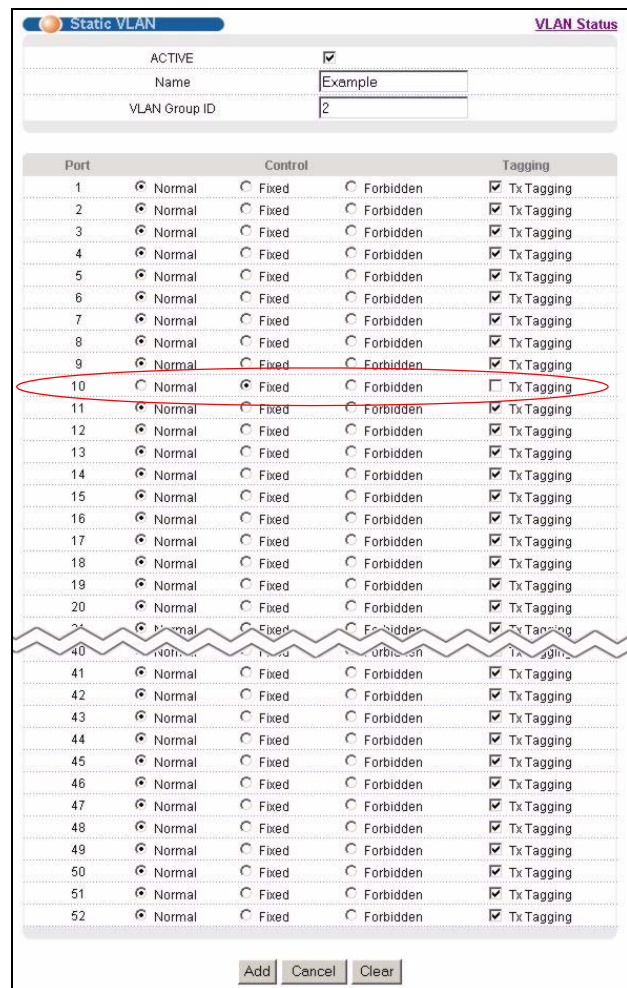

5.1.2 Setting Port VID

Use PVID to add a tag to incoming untagged frames received on that port so that the frames are forwarded to the VLAN group that the tag defines.

In the example network, configure 2 as the port VID on port 10 so that any untagged frames received on that port get sent to VLAN 2.

Figure 23 Initial Setup Network Example: Port VID

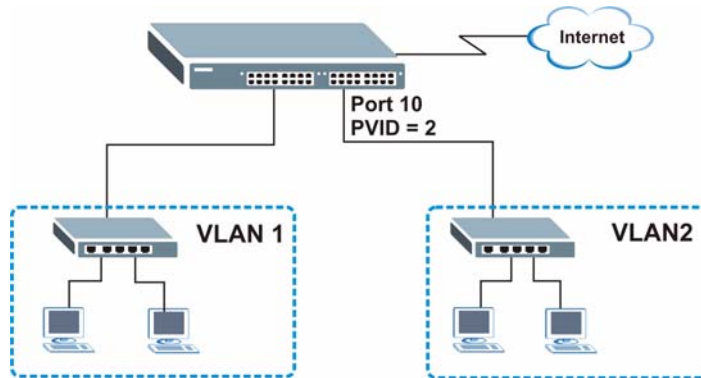

1 Click **Advanced Applications** and **VLAN** in the navigation panel. Then click the **VLAN Port Setting** link.

2 Enter 2 in the **PVID** field for port 10 and click **Apply** to save the settings.

The screenshot shows the 'VLAN Port Setting' configuration page. The page has a title bar with 'VLAN Port Setting' and 'VLAN Status'. Below the title bar, there are two checkboxes: 'GVRP' and 'Port Isolation', both of which are unchecked. The main part of the page is a table with the following columns: Port, Ingress Check, PVID, GVRP, Acceptable Frame Type, and VLAN Trunking. The table lists ports from 1 to 52. The PVID column for port 10 is highlighted with a red oval and contains the value '2'. All other ports have a PVID of '1'. The 'Acceptable Frame Type' column has a dropdown menu set to 'All' for all ports. The 'VLAN Trunking' column has checkboxes that are all unchecked. At the bottom of the page, there are 'Apply' and 'Cancel' buttons.

Port	Ingress Check	PVID	GVRP	Acceptable Frame Type	VLAN Trunking
1	<input type="checkbox"/>	1	<input type="checkbox"/>	All	<input type="checkbox"/>
2	<input type="checkbox"/>	1	<input type="checkbox"/>	All	<input type="checkbox"/>
3	<input type="checkbox"/>	1	<input type="checkbox"/>	All	<input type="checkbox"/>
4	<input type="checkbox"/>	1	<input type="checkbox"/>	All	<input type="checkbox"/>
5	<input type="checkbox"/>	1	<input type="checkbox"/>	All	<input type="checkbox"/>
6	<input type="checkbox"/>	1	<input type="checkbox"/>	All	<input type="checkbox"/>
7	<input type="checkbox"/>	1	<input type="checkbox"/>	All	<input type="checkbox"/>
8	<input type="checkbox"/>	1	<input type="checkbox"/>	All	<input type="checkbox"/>
9	<input type="checkbox"/>	1	<input type="checkbox"/>	All	<input type="checkbox"/>
10	<input type="checkbox"/>	2	<input type="checkbox"/>	All	<input type="checkbox"/>
11	<input type="checkbox"/>	1	<input type="checkbox"/>	All	<input type="checkbox"/>
12	<input type="checkbox"/>	1	<input type="checkbox"/>	All	<input type="checkbox"/>
13	<input type="checkbox"/>	1	<input type="checkbox"/>	All	<input type="checkbox"/>
14	<input type="checkbox"/>	1	<input type="checkbox"/>	All	<input type="checkbox"/>
15	<input type="checkbox"/>	1	<input type="checkbox"/>	All	<input type="checkbox"/>
16	<input type="checkbox"/>	1	<input type="checkbox"/>	All	<input type="checkbox"/>
17	<input type="checkbox"/>	1	<input type="checkbox"/>	All	<input type="checkbox"/>
18	<input type="checkbox"/>	1	<input type="checkbox"/>	All	<input type="checkbox"/>
19	<input type="checkbox"/>	1	<input type="checkbox"/>	All	<input type="checkbox"/>
20	<input type="checkbox"/>	1	<input type="checkbox"/>	All	<input type="checkbox"/>
21	<input type="checkbox"/>	1	<input type="checkbox"/>	All	<input type="checkbox"/>
22	<input type="checkbox"/>	1	<input type="checkbox"/>	All	<input type="checkbox"/>
23	<input type="checkbox"/>	1	<input type="checkbox"/>	All	<input type="checkbox"/>
24	<input type="checkbox"/>	1	<input type="checkbox"/>	All	<input type="checkbox"/>
25	<input type="checkbox"/>	1	<input type="checkbox"/>	All	<input type="checkbox"/>
26	<input type="checkbox"/>	1	<input type="checkbox"/>	All	<input type="checkbox"/>
27	<input type="checkbox"/>	1	<input type="checkbox"/>	All	<input type="checkbox"/>
28	<input type="checkbox"/>	1	<input type="checkbox"/>	All	<input type="checkbox"/>
29	<input type="checkbox"/>	1	<input type="checkbox"/>	All	<input type="checkbox"/>
30	<input type="checkbox"/>	1	<input type="checkbox"/>	All	<input type="checkbox"/>
31	<input type="checkbox"/>	1	<input type="checkbox"/>	All	<input type="checkbox"/>
32	<input type="checkbox"/>	1	<input type="checkbox"/>	All	<input type="checkbox"/>
33	<input type="checkbox"/>	1	<input type="checkbox"/>	All	<input type="checkbox"/>
34	<input type="checkbox"/>	1	<input type="checkbox"/>	All	<input type="checkbox"/>
35	<input type="checkbox"/>	1	<input type="checkbox"/>	All	<input type="checkbox"/>
36	<input type="checkbox"/>	1	<input type="checkbox"/>	All	<input type="checkbox"/>
37	<input type="checkbox"/>	1	<input type="checkbox"/>	All	<input type="checkbox"/>
38	<input type="checkbox"/>	1	<input type="checkbox"/>	All	<input type="checkbox"/>
39	<input type="checkbox"/>	1	<input type="checkbox"/>	All	<input type="checkbox"/>
40	<input type="checkbox"/>	1	<input type="checkbox"/>	All	<input type="checkbox"/>
41	<input type="checkbox"/>	1	<input type="checkbox"/>	All	<input type="checkbox"/>
42	<input type="checkbox"/>	1	<input type="checkbox"/>	All	<input type="checkbox"/>
43	<input type="checkbox"/>	1	<input type="checkbox"/>	All	<input type="checkbox"/>
44	<input type="checkbox"/>	1	<input type="checkbox"/>	All	<input type="checkbox"/>
45	<input type="checkbox"/>	1	<input type="checkbox"/>	All	<input type="checkbox"/>
46	<input type="checkbox"/>	1	<input type="checkbox"/>	All	<input type="checkbox"/>
47	<input type="checkbox"/>	1	<input type="checkbox"/>	All	<input type="checkbox"/>
48	<input type="checkbox"/>	1	<input type="checkbox"/>	All	<input type="checkbox"/>
49	<input type="checkbox"/>	1	<input type="checkbox"/>	All	<input type="checkbox"/>
50	<input type="checkbox"/>	1	<input type="checkbox"/>	All	<input type="checkbox"/>
51	<input type="checkbox"/>	1	<input type="checkbox"/>	All	<input type="checkbox"/>
52	<input type="checkbox"/>	1	<input type="checkbox"/>	All	<input type="checkbox"/>

5.1.3 Configuring Switch Management IP Address

The default management IP address of the switch is 192.168.1.1. You can configure another IP address in a different subnet for management purposes. The following figure shows an example.

Figure 24 Initial Setup Example: Management IP Address

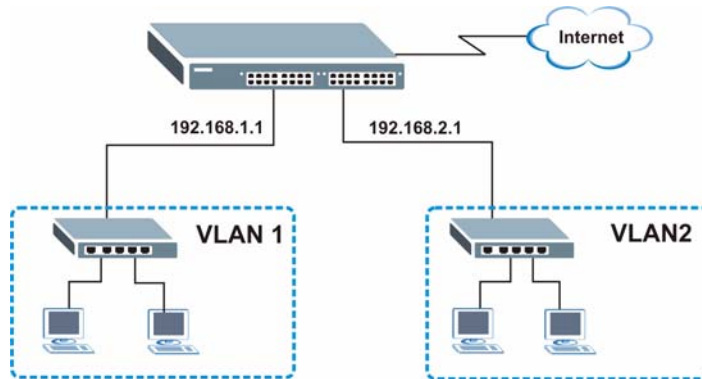

- 1 Connect your computer to any Ethernet port on the switch. Make sure your computer is in the same subnet as the switch.
- 2 Open your web browser and enter 192.168.1.1 (the default IP address) in the address bar to access the web configurator. See [Section 4.2 on page 45](#) for more information.

- 3 Click **Basic Setting** and **IP Setup** in the navigation panel.

- 4 Configure the related fields in the **IP Setup** screen.

For the **VLAN2** network, enter 192.168.2.1 as the IP address and 255.255.255.0 as the subnet mask.

- 5 In the **VID** field, enter the ID of the VLAN group to which you want this management IP address to belong. This is the same as the VLAN ID you configure in the **Static VLAN** screen.

- 6 Select the **Manageable** check box to allow the switch to be managed from the ports belonging to **VLAN2** using this specified IP address.

- 7 Click **Add**.

Index	IP Address	IP Subnet Mask	VID	Default Gateway	Manageable	Delete
	192.168.2.1	255.255.255.0	2	0.0.0.0	<input checked="" type="checkbox"/>	

CHAPTER 6

System Status and Port Statistics

This chapter describes the system status (web configurator home page) and port details screens.

6.1 Overview

The home screen of the web configurator displays a port statistical summary table with links to each port showing statistical details.

6.2 Port Status Summary

To view the port statistics, click **Status** in all web configurator screens to display the **Status** screen as shown next.

Figure 25 Status

The screenshot shows a web interface titled "Status" with a "System Up Time : 0:02:55" indicator. Below this is a table with 11 columns: Port, Link, State, LACP, TxPkts, RxPkts, Errors, Tx KB/s, Rx KB/s, and Up Time. The table lists ports 1 through 52. Ports 1-50 are in a "Down" state with "STOP" STP and "Disabled" LACP, showing 0 for all statistics. Port 51 is in a "100M/F" state with "FORWARDING" STP and "Disabled" LACP, showing 339 TxPkts, 226 RxPkts, and 0:01:44 Up Time. Port 52 is in a "Down" state with "STOP" STP and "Disabled" LACP, showing 239 TxPkts and 189 RxPkts. At the bottom of the table, there are control buttons: "Poll Interval(s) 40" with "Set Interval" and "Stop" buttons, and "Port ALL" with a "Clear Counter" button.

Port	Link	State	LACP	TxPkts	RxPkts	Errors	Tx KB/s	Rx KB/s	Up Time
1	Down	STOP	Disabled	0	0	0	0.0	0.0	0:00:00
2	Down	STOP	Disabled	0	0	0	0.0	0.0	0:00:00
3	Down	STOP	Disabled	0	0	0	0.0	0.0	0:00:00
4	Down	STOP	Disabled	0	0	0	0.0	0.0	0:00:00
5	Down	STOP	Disabled	0	0	0	0.0	0.0	0:00:00
6	Down	STOP	Disabled	0	0	0	0.0	0.0	0:00:00
7	Down	STOP	Disabled	0	0	0	0.0	0.0	0:00:00
8	Down	STOP	Disabled	0	0	0	0.0	0.0	0:00:00
9	Down	STOP	Disabled	0	0	0	0.0	0.0	0:00:00
10	Down	STOP	Disabled	0	0	0	0.0	0.0	0:00:00
11	Down	STOP	Disabled	0	0	0	0.0	0.0	0:00:00
12	Down	STOP	Disabled	0	0	0	0.0	0.0	0:00:00
13	Down	STOP	Disabled	0	0	0	0.0	0.0	0:00:00
14	Down	STOP	Disabled	0	0	0	0.0	0.0	0:00:00
15	Down	STOP	Disabled	0	0	0	0.0	0.0	0:00:00
16	Down	STOP	Disabled	0	0	0	0.0	0.0	0:00:00
17	Down	STOP	Disabled	0	0	0	0.0	0.0	0:00:00
18	Down	STOP	Disabled	0	0	0	0.0	0.0	0:00:00
19	Down	STOP	Disabled	0	0	0	0.0	0.0	0:00:00
20	Down	STOP	Disabled	0	0	0	0.0	0.0	0:00:00
21	Down	STOP	Disabled	0	0	0	0.0	0.0	0:00:00
22	Down	STOP	Disabled	0	0	0	0.0	0.0	0:00:00
23	Down	STOP	Disabled	0	0	0	0.0	0.0	0:00:00
24	Down	STOP	Disabled	0	0	0	0.0	0.0	0:00:00
25	Down	STOP	Disabled	0	0	0	0.0	0.0	0:00:00
26	Down	STOP	Disabled	0	0	0	0.0	0.0	0:00:00
27	Down	STOP	Disabled	0	0	0	0.0	0.0	0:00:00
28	Down	STOP	Disabled	0	0	0	0.0	0.0	0:00:00
29	Down	STOP	Disabled	0	0	0	0.0	0.0	0:00:00
30	Down	STOP	Disabled	0	0	0	0.0	0.0	0:00:00
31	Down	STOP	Disabled	0	0	0	0.0	0.0	0:00:00
32	Down	STOP	Disabled	0	0	0	0.0	0.0	0:00:00
33	Down	STOP	Disabled	0	0	0	0.0	0.0	0:00:00
34	Down	STOP	Disabled	0	0	0	0.0	0.0	0:00:00
35	Down	STOP	Disabled	0	0	0	0.0	0.0	0:00:00
36	Down	STOP	Disabled	0	0	0	0.0	0.0	0:00:00
37	Down	STOP	Disabled	0	0	0	0.0	0.0	0:00:00
38	Down	STOP	Disabled	0	0	0	0.0	0.0	0:00:00
39	Down	STOP	Disabled	0	0	0	0.0	0.0	0:00:00
40	Down	STOP	Disabled	0	0	0	0.0	0.0	0:00:00
41	Down	STOP	Disabled	0	0	0	0.0	0.0	0:00:00
42	Down	STOP	Disabled	0	0	0	0.0	0.0	0:00:00
43	Down	STOP	Disabled	0	0	0	0.0	0.0	0:00:00
44	Down	STOP	Disabled	0	0	0	0.0	0.0	0:00:00
45	Down	STOP	Disabled	0	0	0	0.0	0.0	0:00:00
46	Down	STOP	Disabled	0	0	0	0.0	0.0	0:00:00
47	Down	STOP	Disabled	0	0	0	0.0	0.0	0:00:00
48	Down	STOP	Disabled	0	0	0	0.0	0.0	0:00:00
49	Down	STOP	Disabled	0	0	0	0.0	0.0	0:00:00
50	Down	STOP	Disabled	0	0	0	0.0	0.0	0:00:00
51	100M/F	FORWARDING	Disabled	339	226	0	0.0	0.0	0:01:44
52	Down	STOP	Disabled	239	189	0	0.0	0.0	0:00:00

The following table describes the labels in this screen.

Table 6 Status

LABEL	DESCRIPTION
System up Time	This field shows how long the system has been running since the last time it was started.
Port	This identifies the Ethernet port. Click a port number to display the Port Details screen (refer to Figure 26 on page 62).
Link	This field displays the speed (either 10M for 10Mbps, 100M for 100Mbps or 1000M for 1000Mbps) and the duplex (F for full duplex or H for half). It also shows the cable type (Copper or Fiber) for the combo ports.
State	This field displays the STP (Spanning Tree Protocol) state of the port. See the chapter on STP for details on STP states.
LACP	This fields displays whether LACP (Link Aggregation Control Protocol) has been enabled on the port.

Table 6 Status (continued)

LABEL	DESCRIPTION
TxPkts	This field shows the number of transmitted frames on this port.
RxPkts	This field shows the number of received frames on this port.
Errors	This field shows the number of received errors on this port.
Tx KB/s	This field shows the number of kilobytes per second transmitted on this port.
Rx KB/s	This field shows the number of kilobytes per second received on this port.
Up Time	This field shows the total amount of time in hours, minutes and seconds the port has been up.
Poll Interval(s)	The text box displays how often (in seconds) this screen refreshes. You may change the refresh interval by typing a new number in the text box and then clicking Set Interval.
Stop	Click Stop to halt system statistic polling.
Clear Counter	Select a port from the Port drop-down list box and then click Clear Counter to erase the recorded statistical information for that port.

6.2.1 Status: Port Details

Click a number in the **Port** column in the **Status** screen to display individual port statistics. Use this screen to check status and detailed performance data about an individual port on the switch.

Figure 26 Status: Port Details

Port Info		Port NO.	51
	Link		100M/F
	Status		FORWARDING
	LACP		Disabled
	TxPkts		684
	RxPkts		477
	Errors		0
	Tx KBs/s		0.0
	Rx KBs/s		0.0
	Up Time		0:07:42
TX Packet		TX Packets	684
	Multicast		1
	Broadcast		0
	Pause		523
	Tagged		0
RX Packet		RX Packets	518
	Multicast		18
	Broadcast		0
	Pause		0
	Control		0
TX Collision		Single	0
	Multiple		827847
	Excessive		0
	Late		0
Error Packet		RX CRC	0
	Length		0
	Runt		0
Distribution		64	519
	65 to 127		38
	128 to 255		59
	256 to 511		135
	512 to 1023		30
	1024 to 1518		522
	Giant		0

Poll Interval(s):

The following table describes the labels in this screen.

Table 7 Status: Port Details

LABEL	DESCRIPTION
Port Info	
Link	This field shows whether the Ethernet connection is down, and the speed/duplex mode. It also shows the cable type (Copper or Fiber) for the combo ports.
Status	This field shows the training state of the ports. The states are FORWARDING (forwarding), which means the link is functioning normally or STOP (the port is stopped to break a loop or duplicate path).
LACP	This field shows if LACP is enabled on this port or not.

Table 7 Status: Port Details (continued)

LABEL	DESCRIPTION
TxPkts	This field shows the number of transmitted frames on this port
RxPkts	This field shows the number of received frames on this port
Errors	This field shows the number of received errors on this port.
Tx KB/s	This field shows the number kilobytes per second transmitted on this port.
Rx KB/s	This field shows the number of kilobytes per second received on this port.
Up Time	This field shows the total amount of time the connection has been up.
Tx Packet The following fields display detailed information about packets transmitted.	
TX Packet	This field shows the number of good packets (unicast, multicast and broadcast) transmitted.
Multicast	This field shows the number of good multicast packets transmitted.
Broadcast	This field shows the number of good broadcast packets transmitted.
Pause	This field shows the number of 802.3x Pause packets transmitted.
Tagged	This field shows the number of packets with VLAN tags transmitted.
Rx Packet The following fields display detailed information about packets received.	
RX Packet	This field shows the number of good packets (unicast, multicast and broadcast) received.
Multicast	This field shows the number of good multicast packets received.
Broadcast	This field shows the number of good broadcast packets received.
Pause	This field shows the number of 802.3x Pause packets received.
Control	This field shows the number of control received (including those with CRC error) but it does not include the 802.3x Pause frames.
TX Collision The following fields display information on collisions while transmitting.	
Single	This is a count of successfully transmitted frames for which transmission is inhibited by exactly one collision.
Multiple	This is a count of successfully transmitted frames for which transmission was inhibited by more than one collision.
Excessive	This is a count of frames for which transmission failed due to excessive collisions. Excessive collision is defined as the number of maximum collisions before the retransmission count is reset.
Late	This is the number of times a late collision is detected, that is, after 512 bits of the frame have already been transmitted.
Error Packet	
RX CRC	This field shows the number of packets received with CRC (Cyclic Redundant Check) error(s).
Length	This field shows the number of frames received with a length that was out of range.
Runt	This field shows the number of packets received that were too short (shorter than 64 octets), including the ones with CRC errors.
Distribution	

Table 7 Status: Port Details (continued)

LABEL	DESCRIPTION
64	This field shows the number of packets (including bad packets) received that were 64 octets in length.
65-127	This field shows the number of packets (including bad packets) received that were between 65 and 127 octets in length.
128-255	This field shows the number of packets (including bad packets) received that were between 128 and 255 octets in length.
256-511	This field shows the number of packets (including bad packets) received that were between 256 and 511 octets in length.
512-1023	This field shows the number of packets (including bad packets) received that were between 512 and 1023 octets in length.
1024-1518	This field shows the number of packets (including bad packets) received that were between 1024 and 1518 octets in length.
Giant	This field shows the number of packets dropped because they were bigger than the maximum frame size.
Poll Interval(s)	The text box displays how often (in seconds) this screen refreshes. You may change the refresh interval by typing a new number in the text box and then clicking Set Interval .
Stop	Click Stop to stop port statistic polling.

CHAPTER 7

Basic Setting

This chapter describes how to configure the **System Info**, **General Setup**, **Switch Setup**, **IP Setup** and **Port Setup** screens.

7.1 Overview

The **System Info** screen displays general switch information (such as firmware version number) and hardware polling information (such as fan speeds). The **General Setup** screen allows you to configure general switch identification information. The **General Setup** screen also allows you to set the system time manually or get the current time and date from an external server when you turn on your switch. The real time is then displayed in the switch logs. The **Switch Setup** screen allows you to set up and configure global switch features. The **IP Setup** screen allows you to configure a switch IP address, subnet mask(s) and DNS (domain name server) for management purposes.

7.2 System Information

In the navigation panel, click **Basic Setting** and **System Info** to display the screen as shown. You can check the firmware version number and monitor the switch temperature, fan speeds and voltage in this screen.

Figure 27 System Info

The following table describes the labels in this screen.

Table 8 System Info

LABEL	DESCRIPTION
System Name	This field displays the descriptive name of the switch for identification purposes.
ZyNOS FW Version	This field displays the version number of the switch's current firmware including the date created.
Ethernet Address	This field refers to the Ethernet MAC (Media Access Control) address of the switch.
Hardware Monitor	
Temperature Unit	The switch has temperature sensors that are capable of detecting and reporting if the temperature rises above the threshold. You may choose the temperature unit (Centigrade or Fahrenheit) in this field.
Temperature	MAC , CPU and PHY refer to the location of the temperature sensors on the switch printed circuit board.
Current	This field displays the current temperature measured at this sensor.
MAX	This field displays the maximum temperature measured at this sensor.
MIN	This field displays the minimum temperature measured at this sensor.
Threshold	This field displays the upper temperature limit at this sensor.
Status	This field displays Normal for temperatures below the threshold and Error for those above.

Table 8 System Info (continued)

LABEL	DESCRIPTION
Fan speed (RPM)	A properly functioning fan is an essential component (along with a sufficiently ventilated, cool operating environment) in order for the device to stay within the temperature threshold. Each fan has a sensor that is capable of detecting and reporting if the fan speed falls below the threshold shown.
Current	This field displays this fan's current speed in Revolutions Per Minute (RPM).
MAX	This field displays this fan's maximum speed measured in Revolutions Per Minute (RPM).
MIN	This field displays this fan's minimum speed measured in Revolutions Per Minute (RPM). "<41" is displayed for speeds too small to measure (under 2000 RPM).
Threshold	This field displays the minimum speed at which a normal fan should work.
Status	Normal indicates that this fan is functioning above the minimum speed. Error indicates that this fan is functioning below the minimum speed.
Voltage (V)	The power supply for each voltage has a sensor that is capable of detecting and reporting if the voltage falls out of the tolerance range.
Current	This is the current voltage reading.
MAX	This field displays the maximum voltage measured at this point.
MIN	This field displays the minimum voltage measured at this point.
Threshold	This field displays the minimum voltage at which the switch should work.
Status	Normal indicates that the voltage is within an acceptable operating range at this point; otherwise Error is displayed.
Poll Interval(s)	The text box displays how often (in seconds) this screen refreshes. You may change the refresh interval by typing a new number in the text box and then clicking Set Interval .
Stop	Click Stop to halt statistic polling.

7.3 General Setup

Click **Basic Setting** and **General Setup** in the navigation panel to display the screen as shown.

Figure 28 General Setup

The following table describes the labels in this screen.

Table 9 General Setup

LABEL	DESCRIPTION
System Name	Choose a descriptive name for identification purposes. This name consists of up to 32 printable characters; spaces not allowed.
Location	Enter the geographic location of your switch. You can use up to 32 printable ASCII characters; spaces are not allowed.
Contact Person's Name	Enter the name of the person in charge of this switch. You can use up to 32 printable ASCII characters; spaces are not allowed.
Login Precedence	Use this drop-down list box to select which database the switch should use (first) to authenticate an administrator (user for switch management). Configure the local user accounts in the Access Control Logins screen. The RADIUS is an external server. Before you specify the priority, make sure you have set up the corresponding database correctly first. Select Local Only to have the switch just check the administrator accounts configured in the Access Control Logins screen. Select Local then RADIUS to have the switch check the administrator accounts configured in the Access Control Logins screen. If the user name is not found, the switch then checks the user database on the specified RADIUS server. You need to configure Port Authentication Radius first. Select RADIUS Only to have the switch just check the user database on the specified RADIUS server for a login username and password.

Table 9 General Setup (continued)

LABEL	DESCRIPTION
Use Time Server when Bootup	<p>Enter the time service protocol that your timeserver uses. Not all time servers support all protocols, so you may have to use trial and error to find a protocol that works. The main differences between them are the time format.</p> <p>When you select the Daytime (RFC 867) format, the switch displays the day, month, year and time with no time zone adjustment. When you use this format it is recommended that you use a Daytime timeserver within your geographical time zone.</p> <p>Time (RFC-868) format displays a 4-byte integer giving the total number of seconds since 1970/1/1 at 0:0:0.</p> <p>NTP (RFC-1305) is similar to Time (RFC-868).</p> <p>None is the default value. Enter the time manually. Each time you turn on the switch, the time and date will be reset to 1970-1-1 0:0.</p>
Time Server IP Address	Enter the IP address of your timeserver. The switch searches for the timeserver for up to 60 seconds. If you select a timeserver that is unreachable, then this screen will appear locked for 60 seconds. Please wait.
Current Time	This field displays the time you open this menu (or refresh the menu).
New Time (hh:min:ss)	Enter the new time in hour, minute and second format. The new time then appears in the Current Time field after you click Apply .
Current Date	This field displays the date you open this menu.
New Date (yyyy-mm-dd)	Enter the new date in year, month and day format. The new date then appears in the Current Date field after you click Apply .
Time Zone	Select the time difference between UTC (Universal Time Coordinated, formerly known as GMT, Greenwich Mean Time) and your time zone from the drop-down list box.
Apply	Click Apply to save the settings.
Cancel	Click Cancel to reset the fields to your previous configuration.

7.4 Introduction to VLANs

A VLAN (Virtual Local Area Network) allows a physical network to be partitioned into multiple logical networks. Devices on a logical network belong to one group. A device can belong to more than one group. With VLAN, a device cannot directly talk to or hear from devices that are not in the same group(s); the traffic must first go through a router.

In MTU (Multi-Tenant Unit) applications, VLAN is vital in providing isolation and security among the subscribers. When properly configured, VLAN prevents one subscriber from accessing the network resources of another on the same LAN, thus a user will not see the printers and hard disks of another user in the same building.

VLAN also increases network performance by limiting broadcasts to a smaller and more manageable logical broadcast domain. In traditional switched environments, all broadcast packets go to each and every individual port. With VLAN, all broadcasts are confined to a specific broadcast domain.

Note: VLAN is unidirectional; it only governs outgoing traffic.

See [Chapter 8 on page 77](#) for information on port-based and 802.1Q tagged VLANs.

7.5 Switch Setup Screen

Click **Basic Setting** and then **Switch Setup** in the navigation panel to display the screen as shown. The VLAN setup screens change depending on whether you choose **802.1Q** or **Port Based** in the **VLAN Type** field in this screen. Refer to the chapter on VLAN.

Figure 29 Switch Setup

The following table describes the labels in this screen.

Table 10 Switch Setup

LABEL	DESCRIPTION
VLAN Type	Choose 802.1Q or Port Based . The VLAN Setup screen changes depending on whether you choose 802.1Q VLAN type or Port Based VLAN type in this screen. See Chapter 8 on page 77 for more information.
Bridge Control Protocol Transparency	Select Active to allow the switch to handle bridging control protocols (STP for example). You also need to define how to treat a BPDU in the Port Setup screen.
MAC Address Learning	MAC address learning reduces outgoing traffic broadcasts. For MAC address learning to occur on a port, the port must be active.
Aging Time	Enter a time from 10 to 3000 seconds. This is how long all dynamically learned MAC addresses remain in the MAC address table before they age out (and must be relearned).

Table 10 Switch Setup (continued)

LABEL	DESCRIPTION
	GARP Timer: Switches join VLANs by making a declaration. A declaration is made by issuing a Join message using GARP. Declarations are withdrawn by issuing a Leave message. A Leave All message terminates all registrations. GARP timers set declaration timeout values. See the chapter on VLAN setup for more background information.
Join Timer	Join Timer sets the duration of the Join Period timer for GVRP in milliseconds. Each port has a Join Period timer. The allowed Join Time range is between 100 and 65535 milliseconds; the default is 200 milliseconds. See the chapter on VLAN setup for more background information.
Leave Timer	Leave Time sets the duration of the Leave Period timer for GVRP in milliseconds. Each port has a single Leave Period timer. Leave Time must be two times larger than Join Timer ; the default is 600 milliseconds.
Leave All Timer	Leave All Timer sets the duration of the Leave All Period timer for GVRP in milliseconds. Each port has a single Leave All Period timer. Leave All Timer must be larger than Leave Timer.
<p>Priority Queue Assignment</p> <p>IEEE 802.1p defines up to eight separate traffic types by inserting a tag into a MAC-layer frame that contains bits to define class of service. Frames without an explicit priority tag are given the default priority of the ingress port. Use the next two fields to configure the priority level-to-physical queue mapping.</p> <p>The switch has eight physical queues that you can map to the 8 priority levels. On the switch, traffic assigned to higher index queues gets through faster while traffic in lower index queues is dropped if the network is congested.</p>	
Priority Level (The following descriptions are based on the traffic types defined in the IEEE 802.1d standard (which incorporates the 802.1p)).	
Level 7	Typically used for network control traffic such as router configuration messages.
Level 6	Typically used for voice traffic that is especially sensitive to jitter (jitter is the variations in delay).
Level 5	Typically used for video that consumes high bandwidth and is sensitive to jitter.
Level 4	Typically used for controlled load, latency-sensitive traffic such as SNA (Systems Network Architecture) transactions.
Level 3	Typically used for "excellent effort" or better than best effort and would include important business traffic that can tolerate some delay.
Level 2	This is for "spare bandwidth".
Level 1	This is typically used for non-critical "background" traffic such as bulk transfers that are allowed but that should not affect other applications and users.
Level 0	Typically used for best-effort traffic.
Apply	Click Apply to save the settings.
Cancel	Click Cancel to reset the fields to your previous configuration.

7.6 IP Setup

Use the **IP Setup** screen to configure the default gateway device, the default domain name server and add switch IP address.

7.6.1 Management IP Addresses

The switch needs an IP address for it to be managed over the network. The factory default IP address is 192.168.1.1. The subnet mask specifies the network number portion of an IP address. The factory default subnet mask is 255.255.255.0.

You can configure up to 64 IP addresses which are used to access and manage the switch from the ports belonging to the pre-defined VLAN(s).

Note: You must configure a VLAN first.

Figure 30 IP Setup

IP Setup

Domain Name Server: 0.0.0.0

Default Management: In-band Out-of-band

In-band Management IP Address

DHCP Client

Static IP Address

IP Address: 192.168.1.1

IP Subnet Mask: 255.255.255.0

Default Gateway: 0.0.0.0

VID: 1

Out-of-band Management IP Address

IP Address: 192.168.0.1

IP Subnet Mask: 255.255.255.0

Default Gateway: 0.0.0.0

Apply Cancel

In-band IP Addresses

IP Address	IP Subnet Mask	VID	Default Gateway	Manageable	Delete
0.0.0.0	0.0.0.0		0.0.0.0	<input type="checkbox"/>	

Add Cancel

Index	IP Address	IP Subnet Mask	VID	Default Gateway	Manageable	Delete

Delete Cancel

The following table describes the labels in this screen.

Table 11 IP Setup

LABEL	DESCRIPTION
Domain Name Server	DNS (Domain Name System) is for mapping a domain name to its corresponding IP address and vice versa. Enter a domain name server IP address in order to be able to use a domain name instead of an IP address.
Default Management	Specify which traffic flow (In-Band or Out-of-band) the switch is to send packets originating from itself (such as SNMP traps) or packets with unknown source. Select Out-of-band to have the switch send the packets to the out-of-band management port. This means that device(s) connected to the other port(s) do not receive these packets. Select In-Band to have the switch send the packets to all ports except the out-of-band management port to which connected device(s) do not receive these packets.
In-band Management IP Address	
DHCP Client	Select this option if you have a DHCP server that can assign the switch an IP address, subnet mask, a default gateway IP address and a domain name server IP address automatically.
Static IP Address	Select this option if you don't have a DHCP server or if you wish to assign static IP address information to the switch. You need to fill in the following fields when you select this option.
IP Address	Enter the IP address of your switch in dotted decimal notation for example 192.168.1.1.
IP Subnet Mask	Enter the IP subnet mask of your switch in dotted decimal notation for example 255.255.255.0.
Default Gateway	Enter the IP address of the default outgoing gateway in dotted decimal notation, for example 192.168.1.254.
VID	Enter the VLAN identification number associated with the switch IP address. VID is the VLAN ID of the CPU and is used for management only. The default is "1". All ports, by default, are fixed members of this "management VLAN" in order to manage the device from any port. If a port is not a member of this VLAN, then users on that port cannot access the device. To access the switch make sure the port that you are connected to is a member of Management VLAN.
Out-of-band Management IP Address	
IP Address	Enter the IP address of your switch in dotted decimal notation for example 192.168.0.1. If you change this IP address, make sure the computer connected to this management port is in the same subnet before accessing the switch.
IP Subnet Mask	Enter the IP subnet mask of your switch in dotted decimal notation for example 255.255.255.0.
Default Gateway	Enter the IP address of the default outgoing gateway in dotted decimal notation, for example 192.168.0.254.
Apply	Click Apply to save your changes back to the switch.
Cancel	Click Cancel to begin configuring the fields again.
In-band IP Addresses	You can create up to 64 IP addresses which are used to access and manage the switch from the ports belonging to the pre-defined VLAN(s). You must configure a VLAN first.
IP Address	Enter the IP address for managing the switch by the members of the VLAN specified in the VID field below.
IP Subnet Mask	Enter the IP subnet mask in dotted decimal notation.

Table 11 IP Setup (continued)

LABEL	DESCRIPTION
VID	Type the VLAN group identification number.
Default Gateway	Enter the IP address of the default outgoing gateway in dotted decimal notation.
Manageable	Select this option to allow the switch to be managed using this specified IP address.
Add	Click Add to save the new rule to the switch. It then displays in the summary table at the bottom of the screen.
Cancel	Click Cancel to reset the fields to your previous configuration.
Index	This field displays the index number of an entry. Click an index number to edit the rule.
IP Address	This field displays the IP address.
Subnet Mask	This field displays the subnet mask.
VID	This field displays the VLAN identification number of the network.
Default Gateway	This field displays the the IP address of the default outgoing gateway.
Manageable	This field displays whether the switch can be managed using the specified IP address.
Delete	Click Delete to remove the selected entry from the summary table.
Cancel	Click Cancel to clear the Delete check boxes.

7.7 Port Setup

Click **Basic Setting** and then **Port Setup** in the navigation panel to enter the port configuration screen.

Figure 31 Port Setup

Port	Active	Name	Type	Speed / Duplex	Flow Control	802.1p Priority	BPDU Control
1	<input checked="" type="checkbox"/>	port01	10/100M	Auto	<input type="checkbox"/>	0	Peer
2	<input checked="" type="checkbox"/>	port02	10/100M	Auto	<input type="checkbox"/>	0	Peer
3	<input checked="" type="checkbox"/>	port03	10/100M	Auto	<input type="checkbox"/>	0	Peer
4	<input checked="" type="checkbox"/>	port04	10/100M	Auto	<input type="checkbox"/>	0	Peer
5	<input checked="" type="checkbox"/>	port05	10/100M	Auto	<input type="checkbox"/>	0	Peer
6	<input checked="" type="checkbox"/>	port06	10/100M	Auto	<input type="checkbox"/>	0	Peer
7	<input checked="" type="checkbox"/>	port07	10/100M	Auto	<input type="checkbox"/>	0	Peer
8	<input checked="" type="checkbox"/>	port08	10/100M	Auto	<input type="checkbox"/>	0	Peer
9	<input checked="" type="checkbox"/>	port09	10/100M	Auto	<input type="checkbox"/>	0	Peer
10	<input checked="" type="checkbox"/>	port10	10/100M	Auto	<input type="checkbox"/>	0	Peer
11	<input checked="" type="checkbox"/>	port11	10/100M	Auto	<input type="checkbox"/>	0	Peer
12	<input checked="" type="checkbox"/>	port12	10/100M	Auto	<input type="checkbox"/>	0	Peer
13	<input checked="" type="checkbox"/>	port13	10/100M	Auto	<input type="checkbox"/>	0	Peer
14	<input checked="" type="checkbox"/>	port14	10/100M	Auto	<input type="checkbox"/>	0	Peer
15	<input checked="" type="checkbox"/>	port15	10/100M	Auto	<input type="checkbox"/>	0	Peer
16	<input checked="" type="checkbox"/>	port16	10/100M	Auto	<input type="checkbox"/>	0	Peer
17	<input checked="" type="checkbox"/>	port17	10/100M	Auto	<input type="checkbox"/>	0	Peer
18	<input checked="" type="checkbox"/>	port18	10/100M	Auto	<input type="checkbox"/>	0	Peer
19	<input checked="" type="checkbox"/>	port19	10/100M	Auto	<input type="checkbox"/>	0	Peer
20	<input checked="" type="checkbox"/>	port20	10/100M	Auto	<input type="checkbox"/>	0	Peer
21	<input checked="" type="checkbox"/>	port21	10/100M	Auto	<input type="checkbox"/>	0	Peer
22	<input checked="" type="checkbox"/>	port22	10/100M	Auto	<input type="checkbox"/>	0	Peer
23	<input checked="" type="checkbox"/>	port23	10/100M	Auto	<input type="checkbox"/>	0	Peer
24	<input checked="" type="checkbox"/>	port24	10/100M	Auto	<input type="checkbox"/>	0	Peer
25	<input checked="" type="checkbox"/>	port25	10/100M	Auto	<input type="checkbox"/>	0	Peer
26	<input checked="" type="checkbox"/>	port26	10/100M	Auto	<input type="checkbox"/>	0	Peer
27	<input checked="" type="checkbox"/>	port27	10/100M	Auto	<input type="checkbox"/>	0	Peer
28	<input checked="" type="checkbox"/>	port28	10/100M	Auto	<input type="checkbox"/>	0	Peer
29	<input checked="" type="checkbox"/>	port29	10/100M	Auto	<input type="checkbox"/>	0	Peer
30	<input checked="" type="checkbox"/>	port30	10/100M	Auto	<input type="checkbox"/>	0	Peer
31	<input checked="" type="checkbox"/>	port31	10/100M	Auto	<input type="checkbox"/>	0	Peer
32	<input checked="" type="checkbox"/>	port32	10/100M	Auto	<input type="checkbox"/>	0	Peer
33	<input checked="" type="checkbox"/>	port33	10/100M	Auto	<input type="checkbox"/>	0	Peer
34	<input checked="" type="checkbox"/>	port34	10/100M	Auto	<input type="checkbox"/>	0	Peer
35	<input checked="" type="checkbox"/>	port35	10/100M	Auto	<input type="checkbox"/>	0	Peer
36	<input checked="" type="checkbox"/>	port36	10/100M	Auto	<input type="checkbox"/>	0	Peer
37	<input checked="" type="checkbox"/>	port37	10/100M	Auto	<input type="checkbox"/>	0	Peer
38	<input checked="" type="checkbox"/>	port38	10/100M	Auto	<input type="checkbox"/>	0	Peer
39	<input checked="" type="checkbox"/>	port39	10/100M	Auto	<input type="checkbox"/>	0	Peer
40	<input checked="" type="checkbox"/>	port40	10/100M	Auto	<input type="checkbox"/>	0	Peer
41	<input checked="" type="checkbox"/>	port41	10/100M	Auto	<input type="checkbox"/>	0	Peer
42	<input checked="" type="checkbox"/>	port42	10/100M	Auto	<input type="checkbox"/>	0	Peer
43	<input checked="" type="checkbox"/>	port43	10/100M	Auto	<input type="checkbox"/>	0	Peer
44	<input checked="" type="checkbox"/>	port44	10/100M	Auto	<input type="checkbox"/>	0	Peer
45	<input checked="" type="checkbox"/>	port45	10/100M	Auto	<input type="checkbox"/>	0	Peer
46	<input checked="" type="checkbox"/>	port46	10/100M	Auto	<input type="checkbox"/>	0	Peer
47	<input checked="" type="checkbox"/>	port47	10/100M	Auto	<input type="checkbox"/>	0	Peer
48	<input checked="" type="checkbox"/>	port48	10/100M	Auto	<input type="checkbox"/>	0	Peer
49	<input checked="" type="checkbox"/>	port49	10/100/1000M	Auto	<input type="checkbox"/>	0	Peer
50	<input checked="" type="checkbox"/>	port50	10/100/1000M	Auto	<input type="checkbox"/>	0	Peer
51	<input checked="" type="checkbox"/>	port51	10/100/1000M	Auto	<input type="checkbox"/>	0	Peer
52	<input checked="" type="checkbox"/>	port52	10/100/1000M	Auto	<input type="checkbox"/>	0	Peer

Apply Cancel

The following table describes the labels in this screen.

Table 12 Port Setup

LABEL	DESCRIPTION
Port	This is the port index number.
Active	Select this check box to enable a port. The factory default for all ports is enabled. A port must be enabled for data transmission to occur.
Name	Enter a descriptive name that identifies this port.

Table 12 Port Setup (continued)

LABEL	DESCRIPTION
Type	This field displays 10/100M for an Ethernet/Fast Ethernet connection and 10/100/1000M for Gigabit connections.
Speed/Duplex	<p>Select the speed and the duplex mode of the Ethernet connection on this port. Choices are Auto, 10M/Half Duplex, 10M/Full Duplex, 100M/Half Duplex, 100M/Full Duplex and 1000M/Full Duplex (for Gigabit ports only).</p> <p>Selecting Auto (auto-negotiation) allows one port to negotiate with a peer port automatically to obtain the connection speed and duplex mode that both ends support. When auto-negotiation is turned on, a port on the switch negotiates with the peer automatically to determine the connection speed and duplex mode. If the peer port does not support auto-negotiation or turns off this feature, the switch determines the connection speed by detecting the signal on the cable and using half duplex mode. When the switch's auto-negotiation is turned off, a port uses the pre-configured speed and duplex mode when making a connection, thus requiring you to make sure that the settings of the peer port are the same in order to connect.</p>
Flow Control	<p>A concentration of traffic on a port decreases port bandwidth and overflows buffer memory causing packet discards and frame losses. Flow Control is used to regulate transmission of signals to match the bandwidth of the receiving port.</p> <p>The switch uses IEEE802.3x flow control in full duplex mode and backpressure flow control in half duplex mode.</p> <p>IEEE802.3x flow control is used in full duplex mode to send a pause signal to the sending port, causing it to temporarily stop sending signals when the receiving port memory buffers fill.</p> <p>Back Pressure flow control is typically used in half duplex mode to send a "collision" signal to the sending port (mimicking a state of packet collision) causing the sending port to temporarily stop sending signals and resend later. Select Flow Control to enable it.</p>
802.1p Priority	This priority value is added to incoming frames without a (802.1p) priority queue tag. See Priority Queue Assignment in Table 10 on page 70 for more information.
BPDU Control	<p>Configure the way to treat BPDUs received on this port. You must activate bridging control protocol transparency in the Switch Setup screen first.</p> <p>Select Peer to process any BPDU (Bridge Protocol Data Units) received on this port.</p> <p>Select Tunnel to forward BPDUs received on this port.</p> <p>Select Discard to drop any BPDU received on this port.</p> <p>Select Network to process a BPDU with no VLAN tag and forward a tagged BPDU.</p>
Apply	Click Apply to save the settings.
Cancel	Click Cancel to reset the fields to your previous configuration.

CHAPTER 8

VLAN

The type of screen you see here depends on the **VLAN Type** you selected in the **Switch Setup** screen. This chapter shows you how to configure 802.1Q tagged and port-based VLANs.

8.1 Introduction to IEEE 802.1Q Tagged VLAN

A tagged VLAN uses an explicit tag (VLAN ID) in the MAC header to identify the VLAN membership of a frame across bridges - they are not confined to the switch on which they were created. The VLANs can be created statically by hand or dynamically through GVRP. The VLAN ID associates a frame with a specific VLAN and provides the information that switches need to process the frame across the network. A tagged frame is four bytes longer than an untagged frame and contains two bytes of TPID (Tag Protocol Identifier, residing within the type/length field of the Ethernet frame) and two bytes of TCI (Tag Control Information, starts after the source address field of the Ethernet frame).

The CFI (Canonical Format Indicator) is a single-bit flag, always set to zero for Ethernet switches. If a frame received at an Ethernet port has a CFI set to 1, then that frame should not be forwarded as it is to an untagged port. The remaining twelve bits define the VLAN ID, giving a possible maximum number of 4,096 (2¹²) VLANs. Note that user priority and VLAN ID are independent of each other. A frame with VID (VLAN Identifier) of null (0) is called a priority frame, meaning that only the priority level is significant and the default VID of the ingress port is given as the VID of the frame. Of the 4096 possible VIDs, a VID of 0 is used to identify priority frames and value 4095 (FFF) is reserved, so the maximum possible VLAN configurations are 4,094.

TPID	User Priority	CFI	VLAN ID
2 Bytes	3 Bits	1 Bit	12 bits

8.1.1 Forwarding Tagged and Untagged Frames

Each port on the switch is capable of passing tagged or untagged frames. To forward a frame from an 802.1Q VLAN-aware switch to an 802.1Q VLAN-unaware switch, the switch first decides where to forward the frame and then strips off the VLAN tag. To forward a frame from an 802.1Q VLAN-unaware switch to an 802.1Q VLAN-aware switch, the switch first decides where to forward the frame, and then inserts a VLAN tag reflecting the ingress port's default VID. The default PVID is VLAN 1 for all ports, but this can be changed.

8.2 Automatic VLAN Registration

GARP and GVRP are the protocols used to automatically register VLAN membership across switches.

8.2.1 GARP

GARP (Generic Attribute Registration Protocol) allows network switches to register and de-register attribute values with other GARP participants within a bridged LAN. GARP is a protocol that provides a generic mechanism for protocols that serve a more specific application, for example, GVRP.

8.2.1.1 GARP Timers

Switches join VLANs by making a declaration. A declaration is made by issuing a Join message using GARP. Declarations are withdrawn by issuing a Leave message. A Leave All message terminates all registrations. GARP timers set declaration timeout values.

8.2.2 GVRP

GVRP (GARP VLAN Registration Protocol) is a registration protocol that defines a way for switches to register necessary VLAN members on ports across the network. Enable this function to permit VLANs groups beyond the local switch.

Please refer to the following table for common IEEE 802.1Q VLAN terminology.

Table 13 IEEE 802.1Q VLAN Terminology

VLAN PARAMETER	TERM	DESCRIPTION
VLAN Type	Permanent VLAN	This is a static VLAN created manually.
	Dynamic VLAN	This is a VLAN configured by a GVRP registration/deregistration process.
VLAN Administrative Control	Registration Fixed	Fixed registration ports are permanent VLAN members.
	Registration Forbidden	Ports with registration forbidden are forbidden to join the specified VLAN.
	Normal Registration	Ports dynamically join a VLAN using GVRP.
VLAN Tag Control	Tagged	Ports belonging to the specified VLAN tag all outgoing frames transmitted.
	Untagged	Ports belonging to the specified VLAN don't tag all outgoing frames transmitted.

Table 13 IEEE 802.1Q VLAN Terminology (continued)

VLAN PARAMETER	TERM	DESCRIPTION
VLAN Port	Port VID	This is the VLAN ID assigned to untagged frames that this port received.
	Acceptable frame type	You may choose to accept both tagged and untagged incoming frames or just tagged incoming frames on a port.
	Ingress filtering	If set, the switch discards incoming frames for VLANs that do not have this port as a member

8.3 Port VLAN Trunking

Enable **VLAN Trunking** on a port to allow frames belonging to unknown VLAN groups to pass through that port. This is useful if you want to set up VLAN groups on end devices without having to configure the same VLAN groups on intermediary devices.

Refer to the following figure. Suppose you want to create VLAN groups 1 and 2 (V1 and V2) on devices A and B. Without **VLAN Trunking**, you must configure VLAN groups 1 and 2 on all intermediary switches C, D and E; otherwise they will drop frames with unknown VLAN group tags. However, with **VLAN Trunking** enabled on a port(s) in each intermediary switch you only need to create VLAN groups in the end devices (A and B). C, D and E automatically allow frames with VLAN group tags 1 and 2 (VLAN groups that are unknown to those switches) to pass through their VLAN trunking port(s).

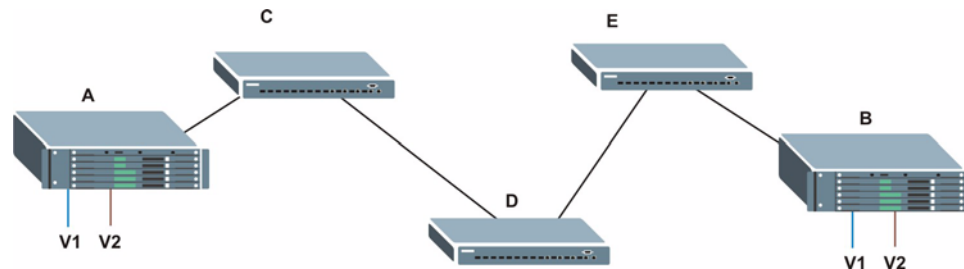
Figure 32 Port VLAN Trunking

8.4 Select the VLAN Type

- 1 Select a VLAN type in the **Switch Setup** screen.

Figure 33 Switch Setup: Select VLAN Type

The screenshot shows the 'Switch Setup' configuration page. The 'VLAN Type' is set to '802.1Q', which is circled in red. Below it, 'Port Based' is also circled in red. At the bottom, 'Bridge Control Protocol Transparency' is set to 'Active'.

8.5 Static VLAN

Use a static VLAN to decide whether an incoming frame on a port should be

- sent to a VLAN group as normal depends on its VLAN tag.
- sent to a group whether it has a VLAN tag or not.
- blocked from a VLAN group regardless of its VLAN tag.

You can also tag all outgoing frames (that were previously untagged) from a port with the specified VID.

8.5.1 Static VLAN Status

Click **Advanced Application**, **VLAN** from the navigation panel to display the **VLAN Status** screen as shown next.

Figure 34 VLAN: VLAN Status

The screenshot shows the 'VLAN Status' page. At the top, it says 'VLAN Status' and 'The Number Of VLAN = 1'. There are two tabs: 'VLAN Port Setting' and 'Static VLAN'. Below the tabs is a table showing the status of ports for VLAN 1.

Index	VID	Port Number																									Elapsed Time	Status									
		2	4	6	8	10	12	14	16	18	20	22	24	26	28	30	32	34	36	38	40	42	44	46	48	50			52								
1	1	U	U	U	U	U	U	U	U	U	U	U	U	U	U	U	U	U	U	U	U	U	U	U	U	U	U	U	U	U	U	U	U	U	U	0:39:53	Static

At the bottom, there are controls for 'Poll Interval(s)' set to 40, with 'Set Interval' and 'Stop' buttons. Below that are 'Change Pages' buttons: 'Previous Page' and 'Next Page'.

The following table describes the labels in this screen.

Table 14 VLAN: VLAN Status

LABEL	DESCRIPTION
The Number of VLAN	This is the number of VLANs configured on the switch.
Index	This is the VLAN index number.
VID	This is the VLAN identification number that was configured in the Static VLAN screen.
Port Number	This column displays the ports that are participating in a VLAN. A tagged port is marked as T , an untagged port is marked as U and ports not participating in a VLAN are marked as “-”.
Elapsed Time	This field shows how long it has been since a normal VLAN was registered or a static VLAN was set up.
Status	This field shows how this VLAN was added to the switch; dynamically using GVRP or statically, that is, added as a permanent entry.
Poll Interval(s)	The text box displays how often (in seconds) this screen refreshes. You may change the refresh interval by typing a new number in the text box and then clicking Set Interval .
Stop	Click Stop to halt polling statistics.
Change Pages	Click Previous Page or Next Page to show the previous/next screen if all status information cannot be seen in one screen.

8.5.2 Configure a Static VLAN

To configure a static VLAN, click **Static VLAN** in the **VLAN Status** screen to display the screen as shown next.

Figure 35 VLAN: Static VLAN

Static VLAN
VLAN Status

ACTIVE

Name

VLAN Group ID

Port	Control			Tagging
1	<input checked="" type="radio"/> Normal	<input type="radio"/> Fixed	<input type="radio"/> Forbidden	<input checked="" type="checkbox"/> Tx Tagging
2	<input checked="" type="radio"/> Normal	<input type="radio"/> Fixed	<input type="radio"/> Forbidden	<input checked="" type="checkbox"/> Tx Tagging
3	<input checked="" type="radio"/> Normal	<input type="radio"/> Fixed	<input type="radio"/> Forbidden	<input checked="" type="checkbox"/> Tx Tagging
4	<input checked="" type="radio"/> Normal	<input type="radio"/> Fixed	<input type="radio"/> Forbidden	<input checked="" type="checkbox"/> Tx Tagging
5	<input checked="" type="radio"/> Normal	<input type="radio"/> Fixed	<input type="radio"/> Forbidden	<input checked="" type="checkbox"/> Tx Tagging
6	<input checked="" type="radio"/> Normal	<input type="radio"/> Fixed	<input type="radio"/> Forbidden	<input checked="" type="checkbox"/> Tx Tagging
7	<input checked="" type="radio"/> Normal	<input type="radio"/> Fixed	<input type="radio"/> Forbidden	<input checked="" type="checkbox"/> Tx Tagging
8	<input checked="" type="radio"/> Normal	<input type="radio"/> Fixed	<input type="radio"/> Forbidden	<input checked="" type="checkbox"/> Tx Tagging
9	<input checked="" type="radio"/> Normal	<input type="radio"/> Fixed	<input type="radio"/> Forbidden	<input checked="" type="checkbox"/> Tx Tagging
10	<input checked="" type="radio"/> Normal	<input type="radio"/> Fixed	<input type="radio"/> Forbidden	<input checked="" type="checkbox"/> Tx Tagging
11	<input checked="" type="radio"/> Normal	<input type="radio"/> Fixed	<input type="radio"/> Forbidden	<input checked="" type="checkbox"/> Tx Tagging
12	<input checked="" type="radio"/> Normal	<input type="radio"/> Fixed	<input type="radio"/> Forbidden	<input checked="" type="checkbox"/> Tx Tagging
13	<input checked="" type="radio"/> Normal	<input type="radio"/> Fixed	<input type="radio"/> Forbidden	<input checked="" type="checkbox"/> Tx Tagging
14	<input checked="" type="radio"/> Normal	<input type="radio"/> Fixed	<input type="radio"/> Forbidden	<input checked="" type="checkbox"/> Tx Tagging
15	<input checked="" type="radio"/> Normal	<input type="radio"/> Fixed	<input type="radio"/> Forbidden	<input checked="" type="checkbox"/> Tx Tagging
16	<input checked="" type="radio"/> Normal	<input type="radio"/> Fixed	<input type="radio"/> Forbidden	<input checked="" type="checkbox"/> Tx Tagging
17	<input checked="" type="radio"/> Normal	<input type="radio"/> Fixed	<input type="radio"/> Forbidden	<input checked="" type="checkbox"/> Tx Tagging
18	<input checked="" type="radio"/> Normal	<input type="radio"/> Fixed	<input type="radio"/> Forbidden	<input checked="" type="checkbox"/> Tx Tagging
19	<input checked="" type="radio"/> Normal	<input type="radio"/> Fixed	<input type="radio"/> Forbidden	<input checked="" type="checkbox"/> Tx Tagging
20	<input checked="" type="radio"/> Normal	<input type="radio"/> Fixed	<input type="radio"/> Forbidden	<input checked="" type="checkbox"/> Tx Tagging
21	<input checked="" type="radio"/> Normal	<input type="radio"/> Fixed	<input type="radio"/> Forbidden	<input checked="" type="checkbox"/> Tx Tagging
22	<input checked="" type="radio"/> Normal	<input type="radio"/> Fixed	<input type="radio"/> Forbidden	<input checked="" type="checkbox"/> Tx Tagging
23	<input checked="" type="radio"/> Normal	<input type="radio"/> Fixed	<input type="radio"/> Forbidden	<input checked="" type="checkbox"/> Tx Tagging
24	<input checked="" type="radio"/> Normal	<input type="radio"/> Fixed	<input type="radio"/> Forbidden	<input checked="" type="checkbox"/> Tx Tagging
25	<input checked="" type="radio"/> Normal	<input type="radio"/> Fixed	<input type="radio"/> Forbidden	<input checked="" type="checkbox"/> Tx Tagging
26	<input checked="" type="radio"/> Normal	<input type="radio"/> Fixed	<input type="radio"/> Forbidden	<input checked="" type="checkbox"/> Tx Tagging
27	<input checked="" type="radio"/> Normal	<input type="radio"/> Fixed	<input type="radio"/> Forbidden	<input checked="" type="checkbox"/> Tx Tagging
28	<input checked="" type="radio"/> Normal	<input type="radio"/> Fixed	<input type="radio"/> Forbidden	<input checked="" type="checkbox"/> Tx Tagging
29	<input checked="" type="radio"/> Normal	<input type="radio"/> Fixed	<input type="radio"/> Forbidden	<input checked="" type="checkbox"/> Tx Tagging
30	<input checked="" type="radio"/> Normal	<input type="radio"/> Fixed	<input type="radio"/> Forbidden	<input checked="" type="checkbox"/> Tx Tagging
31	<input checked="" type="radio"/> Normal	<input type="radio"/> Fixed	<input type="radio"/> Forbidden	<input checked="" type="checkbox"/> Tx Tagging
32	<input checked="" type="radio"/> Normal	<input type="radio"/> Fixed	<input type="radio"/> Forbidden	<input checked="" type="checkbox"/> Tx Tagging
33	<input checked="" type="radio"/> Normal	<input type="radio"/> Fixed	<input type="radio"/> Forbidden	<input checked="" type="checkbox"/> Tx Tagging
34	<input checked="" type="radio"/> Normal	<input type="radio"/> Fixed	<input type="radio"/> Forbidden	<input checked="" type="checkbox"/> Tx Tagging
35	<input checked="" type="radio"/> Normal	<input type="radio"/> Fixed	<input type="radio"/> Forbidden	<input checked="" type="checkbox"/> Tx Tagging
36	<input checked="" type="radio"/> Normal	<input type="radio"/> Fixed	<input type="radio"/> Forbidden	<input checked="" type="checkbox"/> Tx Tagging
37	<input checked="" type="radio"/> Normal	<input type="radio"/> Fixed	<input type="radio"/> Forbidden	<input checked="" type="checkbox"/> Tx Tagging
38	<input checked="" type="radio"/> Normal	<input type="radio"/> Fixed	<input type="radio"/> Forbidden	<input checked="" type="checkbox"/> Tx Tagging
39	<input checked="" type="radio"/> Normal	<input type="radio"/> Fixed	<input type="radio"/> Forbidden	<input checked="" type="checkbox"/> Tx Tagging
40	<input checked="" type="radio"/> Normal	<input type="radio"/> Fixed	<input type="radio"/> Forbidden	<input checked="" type="checkbox"/> Tx Tagging
41	<input checked="" type="radio"/> Normal	<input type="radio"/> Fixed	<input type="radio"/> Forbidden	<input checked="" type="checkbox"/> Tx Tagging
42	<input checked="" type="radio"/> Normal	<input type="radio"/> Fixed	<input type="radio"/> Forbidden	<input checked="" type="checkbox"/> Tx Tagging
43	<input checked="" type="radio"/> Normal	<input type="radio"/> Fixed	<input type="radio"/> Forbidden	<input checked="" type="checkbox"/> Tx Tagging
44	<input checked="" type="radio"/> Normal	<input type="radio"/> Fixed	<input type="radio"/> Forbidden	<input checked="" type="checkbox"/> Tx Tagging
45	<input checked="" type="radio"/> Normal	<input type="radio"/> Fixed	<input type="radio"/> Forbidden	<input checked="" type="checkbox"/> Tx Tagging
46	<input checked="" type="radio"/> Normal	<input type="radio"/> Fixed	<input type="radio"/> Forbidden	<input checked="" type="checkbox"/> Tx Tagging
47	<input checked="" type="radio"/> Normal	<input type="radio"/> Fixed	<input type="radio"/> Forbidden	<input checked="" type="checkbox"/> Tx Tagging
48	<input checked="" type="radio"/> Normal	<input type="radio"/> Fixed	<input type="radio"/> Forbidden	<input checked="" type="checkbox"/> Tx Tagging
49	<input checked="" type="radio"/> Normal	<input type="radio"/> Fixed	<input type="radio"/> Forbidden	<input checked="" type="checkbox"/> Tx Tagging
50	<input checked="" type="radio"/> Normal	<input type="radio"/> Fixed	<input type="radio"/> Forbidden	<input checked="" type="checkbox"/> Tx Tagging
51	<input checked="" type="radio"/> Normal	<input type="radio"/> Fixed	<input type="radio"/> Forbidden	<input checked="" type="checkbox"/> Tx Tagging
52	<input checked="" type="radio"/> Normal	<input type="radio"/> Fixed	<input type="radio"/> Forbidden	<input checked="" type="checkbox"/> Tx Tagging

VID	Active	Name	Delete
1	Yes	1	<input type="checkbox"/>

The following table describes the related labels in this screen.

Table 15 VLAN: Static VLAN

LABEL	DESCRIPTION
ACTIVE	Select this check box to activate the VLAN settings.
Name	Enter a descriptive name for the VLAN group for identification purposes.
VLAN Group ID	Enter the VLAN ID for this static entry; the valid range is between 1 and 4094.
Port	The port number identifies the port you are configuring.
Control	Select Normal for the port to dynamically join this VLAN group using GVRP. This is the default selection. Select Fixed for the port to be a permanent member of this VLAN group. Select Forbidden if you want to prohibit the port from joining this VLAN group.
Tagging	Select TX Tagging if you want the port to tag all outgoing frames transmitted with this VLAN Group ID.
Add	Click Add to add the settings as a new entry in the summary table below.
Cancel	Click Cancel to reset the fields.
Clear	Click Clear to start configuring the screen again.
VID	This field displays the ID number of the VLAN group. Click the number to edit the VLAN settings.
Active	This field indicates whether the VLAN settings are enabled (Yes) or disabled (No).
Name	This field displays the descriptive name for this VLAN group.
Delete	Click Delete to remove the selected entry from the summary table.
Cancel	Click Cancel to clear the Delete check boxes.

8.5.3 Configure VLAN Port Settings

To configure the VLAN settings on a port, click the **VLAN Port Setting** link in the **VLAN Status** screen.

Figure 36 VLAN: VLAN Port Setting

VLAN Port Setting
VLAN Status

GVRP

Port isolation

Port	Ingress Check	PVID	GVRP	Acceptable Frame Type	VLAN Trunking
1	<input type="checkbox"/>	1	<input type="checkbox"/>	All	<input type="checkbox"/>
2	<input type="checkbox"/>	1	<input type="checkbox"/>	All	<input type="checkbox"/>
3	<input type="checkbox"/>	1	<input type="checkbox"/>	All	<input type="checkbox"/>
4	<input type="checkbox"/>	1	<input type="checkbox"/>	All	<input type="checkbox"/>
5	<input type="checkbox"/>	1	<input type="checkbox"/>	All	<input type="checkbox"/>
6	<input type="checkbox"/>	1	<input type="checkbox"/>	All	<input type="checkbox"/>
7	<input type="checkbox"/>	1	<input type="checkbox"/>	All	<input type="checkbox"/>
8	<input type="checkbox"/>	1	<input type="checkbox"/>	All	<input type="checkbox"/>
9	<input type="checkbox"/>	1	<input type="checkbox"/>	All	<input type="checkbox"/>
10	<input type="checkbox"/>	1	<input type="checkbox"/>	All	<input type="checkbox"/>
11	<input type="checkbox"/>	1	<input type="checkbox"/>	All	<input type="checkbox"/>
12	<input type="checkbox"/>	1	<input type="checkbox"/>	All	<input type="checkbox"/>
13	<input type="checkbox"/>	1	<input type="checkbox"/>	All	<input type="checkbox"/>
14	<input type="checkbox"/>	1	<input type="checkbox"/>	All	<input type="checkbox"/>
15	<input type="checkbox"/>	1	<input type="checkbox"/>	All	<input type="checkbox"/>
16	<input type="checkbox"/>	1	<input type="checkbox"/>	All	<input type="checkbox"/>
17	<input type="checkbox"/>	1	<input type="checkbox"/>	All	<input type="checkbox"/>
18	<input type="checkbox"/>	1	<input type="checkbox"/>	All	<input type="checkbox"/>
19	<input type="checkbox"/>	1	<input type="checkbox"/>	All	<input type="checkbox"/>
20	<input type="checkbox"/>	1	<input type="checkbox"/>	All	<input type="checkbox"/>
21	<input type="checkbox"/>	1	<input type="checkbox"/>	All	<input type="checkbox"/>
22	<input type="checkbox"/>	1	<input type="checkbox"/>	All	<input type="checkbox"/>
43	<input type="checkbox"/>	1	<input type="checkbox"/>	All	<input type="checkbox"/>
44	<input type="checkbox"/>	1	<input type="checkbox"/>	All	<input type="checkbox"/>
45	<input type="checkbox"/>	1	<input type="checkbox"/>	All	<input type="checkbox"/>
46	<input type="checkbox"/>	1	<input type="checkbox"/>	All	<input type="checkbox"/>
47	<input type="checkbox"/>	1	<input type="checkbox"/>	All	<input type="checkbox"/>
48	<input type="checkbox"/>	1	<input type="checkbox"/>	All	<input type="checkbox"/>
49	<input type="checkbox"/>	1	<input type="checkbox"/>	All	<input type="checkbox"/>
50	<input type="checkbox"/>	1	<input type="checkbox"/>	All	<input type="checkbox"/>
51	<input type="checkbox"/>	1	<input type="checkbox"/>	All	<input type="checkbox"/>
52	<input type="checkbox"/>	1	<input type="checkbox"/>	All	<input type="checkbox"/>

The following table describes the labels in this screen.

Table 16 VLAN: VLAN Port Setting

LABEL	DESCRIPTION
GVRP	GVRP (GARP VLAN Registration Protocol) is a registration protocol that defines a way for switches to register necessary VLAN members on ports across the network. Select this check box to permit VLAN groups beyond the local switch.
Port Isolation	Port Isolation allows each port (1 to 26) to communicate only with the CPU management port but not communicate with each other. All incoming ports are selected while only the CPU outgoing port is selected. This option is the most limiting but also the most secure.
Port	This field displays the port number.
Ingress Check	If this check box is selected for a port, the device discards incoming frames for VLANs that do not include this port in its member set. Clear this check box to disable ingress filtering.
PVID	Enter a number between 1 and 4094 as the port VLAN ID.
GVRP	Select this check box to allow GVRP on this port.
Acceptable Frame Type	Specify the type of frames allowed on a port. Choices are All and Tag Only . Select All from the drop-down list box to accept all untagged or tagged frames on this port. This is the default setting. Select Tag Only to accept only tagged frames on this port. All untagged frames will be dropped.
VLAN Trunking	Enable VLAN Trunking on ports connected to other switches or routers (but not ports directly connected to end users) to allow frames belonging to unknown VLAN groups to pass through the switch.
Apply	Click Apply to save the changes
Cancel	Click Cancel to start configuring the screen again.

8.6 Port-based VLAN Setup

Port-based VLANs are VLANs where the packet forwarding decision is based on the destination MAC address and its associated port.

Port-based VLANs require allowed outgoing ports to be defined for each port. Therefore, if you wish to allow two subscriber ports to talk to each other, for example, between conference rooms in a hotel, you must define the egress (an egress port is an outgoing port, that is, a port through which a data packet leaves) for both ports.

Port-based VLANs are specific only to the switch on which they were created.

Note: When you activate port-based VLAN, the switch uses a default VLAN ID of 1. You cannot change it.

In screens (such as **IP Setup** and **Filtering**) that require a VID, you must enter 1 as the VID.

The port-based VLAN setup screen is shown next. The CPU management port forms a VLAN with all Ethernet ports.

8.6.1 Configure a Port-based VLAN

Select **Port Based** as the **VLAN Type** in the **Switch Setup** screen (see [Figure 33 on page 80](#)) and then click **VLAN** from the navigation panel to display the next screen.

Figure 37 Port Based VLAN Setup (All Connected)

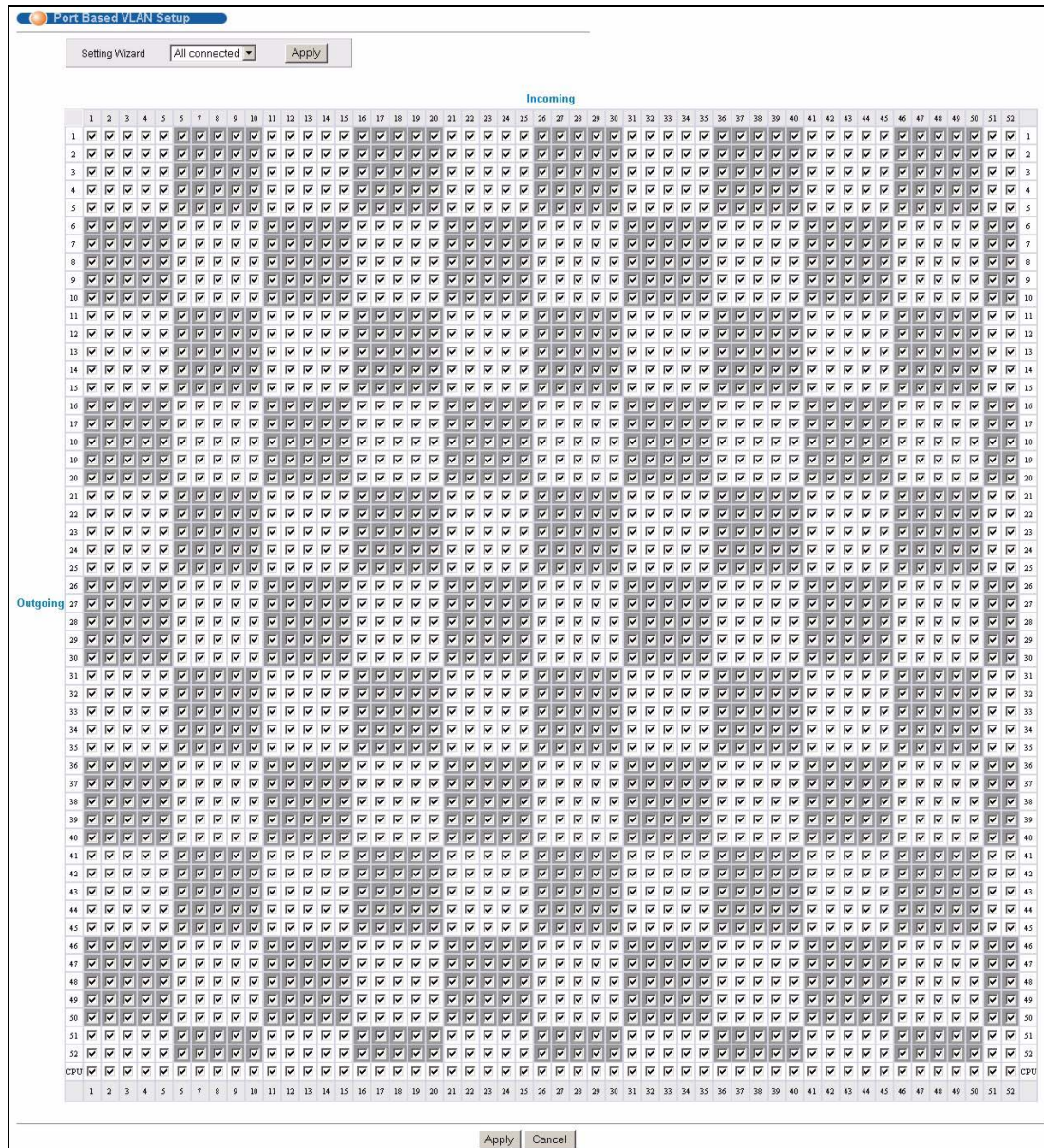

The following table describes the labels in this screen.

Table 17 Port Based VLAN Setup

LABEL	DESCRIPTION
Setting Wizard	<p>Choose All connected or Port isolation.</p> <p>All connected means all ports can communicate with each other, that is, there are no virtual LANs. All incoming and outgoing ports are selected. This option is the most flexible but also the least secure.</p> <p>Port isolation means that each port can only communicate with the CPU management port and cannot communicate with each other. All incoming ports are selected while only the CPU outgoing port is selected. This option is the most limiting but also the most secure.</p> <p>After you make your selection, click Apply (top right of screen) to display the screens as mentioned above. You can still customize these settings by adding/deleting incoming or outgoing ports, but you must also click Apply at the bottom of the screen.</p>
Incoming	<p>These are the ingress ports; an ingress port is an incoming port, that is, a port through which a data packet enters. If you wish to allow two subscriber ports to talk to each other, you must define the ingress port for both ports. The numbers in the top row denote the incoming port for the corresponding port listed on the left (its outgoing port). CPU refers to the switch management port. By default it forms a VLAN with all Ethernet ports. If it does not form a VLAN with a particular port then the switch cannot be managed from that port.</p>
Outgoing	<p>These are the egress ports; an egress port is an outgoing port, that is, a port through which a data packet leaves. If you wish to allow two subscriber ports to talk to each other, you must define the egress port for both ports. CPU refers to the switch management port. By default it forms a VLAN with all Ethernet ports. If it does not form a VLAN with a particular port then the switch cannot be managed from that port.</p>
Apply	Click Apply to save the changes.
Cancel	Click Cancel to start configuring the screen again.

CHAPTER 9

Static MAC Forwarding

Use these screens to configure static MAC address forwarding.

9.1 Overview

A static MAC address is an address that has been manually entered in the MAC address table. Static MAC addresses do not age out. When you set up static MAC address rules, you are setting static MAC addresses for a port. This may reduce the need for broadcasting.

Static MAC address forwarding together with port security allow only computers in the MAC address table on a port to access the switch. See [Chapter 17 on page 121](#) for more information on port security.

9.2 Configuring Static MAC Forwarding

Click **Advanced Applications, Static MAC Forwarding** in the navigation panel to display the configuration screen as shown.

Figure 39 Static MAC Forwarding

Index	Active	Name	MAC Address	VID	Port	Delete
1	Yes	Ex	0a:b2:a0:81:f3:7e	1	1	<input type="checkbox"/>

The following table describes the labels in this screen.

Table 18 Static MAC Forwarding

LABEL	DESCRIPTION
Active	Select this check box to activate your rule. You may temporarily deactivate a rule without deleting it by clearing this check box.
Name	Enter a descriptive name for identification purposes for this static MAC address forwarding rule.
MAC Address	Enter the MAC address in valid MAC address format, that is, six hexadecimal character pairs. Note: Static MAC addresses do not age out.
VID	Enter the VLAN identification number.
Port	Select a port where the MAC address entered in the previous field will be automatically forwarded.
Add	After you set the fields above, click Add to insert a new rule.
Cancel	Click Cancel to reset the fields.
Clear	Click Clear to begin configuring this screen afresh.
Index	Click an index number to modify a static MAC address rule for a port.
Active	This field displays whether this static MAC address forwarding rule is active (Yes) or not (No). You may temporarily deactivate a rule without deleting it.
Name	This field displays the descriptive name for identification purposes for this static MAC address-forwarding rule.
MAC Address	This field displays the MAC address that will be forwarded and the VLAN identification number to which the MAC address belongs.
VID	This field displays the ID number of the VLAN group.
Port	This field displays the port where the MAC address shown in the next field will be forwarded.
Delete	Click Delete to remove the selected entry from the summary table.
Cancel	Click Cancel to clear the Delete check boxes.

CHAPTER 10

Filtering

This chapter discusses static IP and MAC address port filtering.

10.1 Introduction to Filtering

Filtering means sifting traffic going through the switch based on the source and/or destination MAC addresses and VLAN group (ID).

10.2 Configure a Filtering Rule

Click **Advanced Application** and **Filtering** in the navigation panel to display the screen as shown next.

Figure 40 Filtering

Filtering

Active

Name

Action Discard source
 Discard destination

MAC : : : : :

VID

Add Cancel Clear

Index	Active	Name	MAC Address	Action	Delete
-------	--------	------	-------------	--------	--------

Delete Cancel

The following table describes the related labels in this screen.

Table 19 Filtering

LABEL	DESCRIPTION
Active	Make sure to select this check box to activate your rule. You may temporarily deactivate a rule without deleting it by deselecting this check box.
Name	Type a descriptive name (up to 32 printable ASCII characters) for this rule. This is for identification purpose only.
Action	<p>Select Discard source to drop frame from the source MAC address (specified in the MAC field). The switch can still send frames to the MAC address.</p> <p>Select Discard destination to drop frames to the destination MAC address (specified in the MAC address). The switch can still receive frames originating from the MAC address.</p> <p>Select Discard source and Discard destination to block traffic to/from the MAC address specified in the MAC field.</p>
MAC	Type a MAC address in valid MAC address format, that is, six hexadecimal character pairs.
VID	Type the VLAN group identification number.
Add	Click Add to save the new rule to the switch. It then displays in the summary table at the bottom of the screen.
Cancel	Click Cancel to reset the fields to your previous configuration.
Clear	Click Clear to clear the fields to the factory defaults.
Index	This field displays the index number of the rule. Click an index number to change the settings.
Active	This field displays Yes when the rule is activated and No when is it deactivated.
Name	This field displays the descriptive name for this rule. This is for identification purpose only.
MAC Address	This field displays the source/destination MAC address with the VLAN identification number to which the MAC address belongs.
Action	This field displays the filtering action (Discard both , Discard source or Discard dest.).
Delete	Check the rule(s) that you want to remove in the Delete column and then click the Delete button.
Cancel	Click Cancel to clear the selected checkbox(es) in the Delete column.

CHAPTER 11

Spanning Tree Protocol

This chapter introduces the Spanning Tree Protocol (STP) and Rapid Spanning Tree Protocol (RSTP).

11.1 STP/RSTP Overview

(R)STP detects and breaks network loops and provides backup links between switches, bridges or routers. It allows a switch to interact with other (R)STP -compliant switches in your network to ensure that only one path exists between any two stations on the network.

The switch uses IEEE 802.1w RSTP (Rapid Spanning Tree Protocol) that allow faster convergence of the spanning tree than STP (while also being backwards compatible with STP-only aware bridges). In RSTP, topology change information is directly propagated throughout the network from the device that generates the topology change. In STP, a longer delay is required as the device that causes a topology change first notifies the root bridge that then notifies the network. Both RSTP and STP flush unwanted learned addresses from the filtering database. In RSTP, the port states are Discarding, Learning, and Forwarding.

Note: In this user's guide, "STP" refers to both STP and RSTP.

11.1.1 STP Terminology

The root bridge is the base of the spanning tree; it is the bridge with the lowest identifier value (MAC address).

Path cost is the cost of transmitting a frame onto a LAN through that port. It is assigned according to the speed of the link to which a port is attached. The slower the media, the higher the cost.

Table 20 STP Path Costs

	LINK SPEED	RECOMMENDED VALUE	RECOMMENDED RANGE	ALLOWED RANGE
Path Cost	4Mbps	250	100 to 1000	1 to 65535
Path Cost	10Mbps	100	50 to 600	1 to 65535
Path Cost	16Mbps	62	40 to 400	1 to 65535
Path Cost	100Mbps	19	10 to 60	1 to 65535
Path Cost	1Gbps	4	3 to 10	1 to 65535
Path Cost	10Gbps	2	1 to 5	1 to 65535

On each bridge, the root port is the port through which this bridge communicates with the root. It is the port on this switch with the lowest path cost to the root (the root path cost). If there is no root port, then this switch has been accepted as the root bridge of the spanning tree network.

For each LAN segment, a designated bridge is selected. This bridge has the lowest cost to the root among the bridges connected to the LAN.

11.1.2 How STP Works

After a bridge determines the lowest cost-spanning tree with STP, it enables the root port and the ports that are the designated ports for connected LANs, and disables all other ports that participate in STP. Network packets are therefore only forwarded between enabled ports, eliminating any possible network loops.

STP-aware switches exchange Bridge Protocol Data Units (BPDUs) periodically. When the bridged LAN topology changes, a new spanning tree is constructed.

Once a stable network topology has been established, all bridges listen for Hello BPDUs (Bridge Protocol Data Units) transmitted from the root bridge. If a bridge does not get a Hello BPDUs after a predefined interval (Max Age), the bridge assumes that the link to the root bridge is down. This bridge then initiates negotiations with other bridges to reconfigure the network to re-establish a valid network topology.

11.1.3 STP Port States

STP assigns five port states to eliminate packet looping. A bridge port is not allowed to go directly from blocking state to forwarding state so as to eliminate transient loops.

Table 21 STP Port States

PORT STATE	DESCRIPTION
Disabled	STP is disabled (default).
Blocking	Only configuration and management BPDUs are received and processed.
Listening	All BPDUs are received and processed.
Learning	All BPDUs are received and processed. Information frames are submitted to the learning process but not forwarded.
Forwarding	All BPDUs are received and processed. All information frames are received and forwarded.

11.2 STP Status

Click **Advanced Application, Spanning Tree Protocol** in the navigation panel to display the status screen as shown next.

Figure 41 Spanning Tree Protocol: Status

Bridge	Root	Our Bridge
Bridge ID	8000-001349000002	8000-001349000002
Hello Time (second)	2	2
Max Age (second)	20	20
Forwarding Delay (second)	15	15
Cost to Bridge	0	
Port ID	0X0000	
Topology Changed Times		0
Time Since Last Change		0:41:42

Polling Interval:

The following table describes the labels in this screen.

Table 22 Spanning Tree Protocol: Status

LABEL	DESCRIPTION
Spanning Tree Protocol	This field displays Running if STP is activated. Otherwise, it displays Down .
Configuration	Click Configuration to configure STP settings. Refer to Section 11.3 on page 96 .
Bridge	Root refers to the base of the spanning tree (the root bridge). Our Bridge is this switch. This switch may also be the root bridge.
Bridge ID	This is the unique identifier for this bridge, consisting of bridge priority plus MAC address. This ID is the same for Root and Our Bridge if the switch is the root switch.
Hello Time (second)	This is the time interval (in seconds) at which the root switch transmits a configuration message. The root bridge determines Hello Time , Max Age and Forwarding Delay .
Max Age (second)	This is the maximum time (in seconds) a switch can wait without receiving a configuration message before attempting to reconfigure.
Forwarding Delay (second)	This is the time (in seconds) the root switch will wait before changing states (that is, listening to learning to forwarding).
Cost to Bridge	This is the path cost from the root port on this switch to the root switch.
Port ID	This is the priority and number of the port on the switch through which this switch must communicate with the root of the Spanning Tree.
Topology Changed Times	This is the number of times the spanning tree has been reconfigured.
Time Since Last Change	This is the time since the spanning tree was last reconfigured.

Table 22 Spanning Tree Protocol: Status (continued)

LABEL	DESCRIPTION
Polling Interval	The text box displays how often (in seconds) this screen refreshes. You may change the refresh interval by typing a new number in the text box and then clicking Set Interval .
Stop	Click Stop to halt STP statistic polling.

11.3 Configure STP

To configure STP, click the **Configuration** link in the **Spanning Tree Protocol** screen as shown next.

Figure 42 Spanning Tree Protocol: Configuration

Spanning Tree Protocol
Status

Active

Bridge Priority

Hello Time Seconds

Max Age Seconds

Forwarding Delay Seconds

Port	Active	Priority	Path Cost
1	<input type="checkbox"/>	<input type="text" value="128"/>	<input type="text" value="19"/>
2	<input type="checkbox"/>	<input type="text" value="128"/>	<input type="text" value="19"/>
3	<input type="checkbox"/>	<input type="text" value="128"/>	<input type="text" value="19"/>
4	<input type="checkbox"/>	<input type="text" value="128"/>	<input type="text" value="19"/>
5	<input type="checkbox"/>	<input type="text" value="128"/>	<input type="text" value="19"/>
6	<input type="checkbox"/>	<input type="text" value="128"/>	<input type="text" value="19"/>
7	<input type="checkbox"/>	<input type="text" value="128"/>	<input type="text" value="19"/>
8	<input type="checkbox"/>	<input type="text" value="128"/>	<input type="text" value="19"/>
9	<input type="checkbox"/>	<input type="text" value="128"/>	<input type="text" value="19"/>
10	<input type="checkbox"/>	<input type="text" value="128"/>	<input type="text" value="19"/>
11	<input type="checkbox"/>	<input type="text" value="128"/>	<input type="text" value="19"/>
12	<input type="checkbox"/>	<input type="text" value="128"/>	<input type="text" value="19"/>
13	<input type="checkbox"/>	<input type="text" value="128"/>	<input type="text" value="19"/>
14	<input type="checkbox"/>	<input type="text" value="128"/>	<input type="text" value="19"/>
15	<input type="checkbox"/>	<input type="text" value="128"/>	<input type="text" value="19"/>
16	<input type="checkbox"/>	<input type="text" value="128"/>	<input type="text" value="19"/>
17	<input type="checkbox"/>	<input type="text" value="128"/>	<input type="text" value="19"/>
18	<input type="checkbox"/>	<input type="text" value="128"/>	<input type="text" value="19"/>
19	<input type="checkbox"/>	<input type="text" value="128"/>	<input type="text" value="19"/>
20	<input type="checkbox"/>	<input type="text" value="128"/>	<input type="text" value="19"/>
21	<input type="checkbox"/>	<input type="text" value="128"/>	<input type="text" value="19"/>
22	<input type="checkbox"/>	<input type="text" value="128"/>	<input type="text" value="19"/>
23	<input type="checkbox"/>	<input type="text" value="128"/>	<input type="text" value="19"/>
24	<input type="checkbox"/>	<input type="text" value="128"/>	<input type="text" value="19"/>
25	<input type="checkbox"/>	<input type="text" value="128"/>	<input type="text" value="19"/>
26	<input type="checkbox"/>	<input type="text" value="128"/>	<input type="text" value="19"/>
27	<input type="checkbox"/>	<input type="text" value="128"/>	<input type="text" value="19"/>
28	<input type="checkbox"/>	<input type="text" value="128"/>	<input type="text" value="19"/>
29	<input type="checkbox"/>	<input type="text" value="128"/>	<input type="text" value="19"/>
30	<input type="checkbox"/>	<input type="text" value="128"/>	<input type="text" value="19"/>
31	<input type="checkbox"/>	<input type="text" value="128"/>	<input type="text" value="19"/>
32	<input type="checkbox"/>	<input type="text" value="128"/>	<input type="text" value="19"/>
33	<input type="checkbox"/>	<input type="text" value="128"/>	<input type="text" value="19"/>
34	<input type="checkbox"/>	<input type="text" value="128"/>	<input type="text" value="19"/>
35	<input type="checkbox"/>	<input type="text" value="128"/>	<input type="text" value="19"/>
36	<input type="checkbox"/>	<input type="text" value="128"/>	<input type="text" value="19"/>
37	<input type="checkbox"/>	<input type="text" value="128"/>	<input type="text" value="19"/>
38	<input type="checkbox"/>	<input type="text" value="128"/>	<input type="text" value="19"/>
39	<input type="checkbox"/>	<input type="text" value="128"/>	<input type="text" value="19"/>
40	<input type="checkbox"/>	<input type="text" value="128"/>	<input type="text" value="19"/>
41	<input type="checkbox"/>	<input type="text" value="128"/>	<input type="text" value="19"/>
42	<input type="checkbox"/>	<input type="text" value="128"/>	<input type="text" value="19"/>
43	<input type="checkbox"/>	<input type="text" value="128"/>	<input type="text" value="19"/>
44	<input type="checkbox"/>	<input type="text" value="128"/>	<input type="text" value="19"/>
45	<input type="checkbox"/>	<input type="text" value="128"/>	<input type="text" value="19"/>
46	<input type="checkbox"/>	<input type="text" value="128"/>	<input type="text" value="19"/>
47	<input type="checkbox"/>	<input type="text" value="128"/>	<input type="text" value="19"/>
48	<input type="checkbox"/>	<input type="text" value="128"/>	<input type="text" value="19"/>
49	<input type="checkbox"/>	<input type="text" value="128"/>	<input type="text" value="4"/>
50	<input type="checkbox"/>	<input type="text" value="128"/>	<input type="text" value="4"/>
51	<input type="checkbox"/>	<input type="text" value="128"/>	<input type="text" value="4"/>
52	<input type="checkbox"/>	<input type="text" value="128"/>	<input type="text" value="4"/>

The following table describes the labels in this screen.

Table 23 Spanning Tree Protocol: Configuration

LABEL	DESCRIPTION
Status	Click Status to display the Spanning Tree Protocol Status screen (see Figure 41 on page 95).
Active	Select this check box to activate STP. Clear this checkbox to disable STP.
Bridge Priority	<p>Bridge priority is used in determining the root switch, root port and designated port. The switch with the highest priority (lowest numeric value) becomes the STP root switch. If all switches have the same priority, the switch with the lowest MAC address will then become the root switch. Select a value from the drop-down list box.</p> <p>The lower the numeric value you assign, the higher the priority for this bridge.</p> <p>Bridge Priority determines the root bridge, which in turn determines Hello Time, Max Age and Forwarding Delay.</p>
Hello Time	This is the time interval in seconds between BPDU (Bridge Protocol Data Units) configuration message generations by the root switch. The allowed range is 1 to 10 seconds.
Max Age	This is the maximum time (in seconds) a switch can wait without receiving a BPDU before attempting to reconfigure. All switch ports (except for designated ports) should receive BPDUs at regular intervals. Any port that ages out STP information (provided in the last BPDU) becomes the designated port for the attached LAN. If it is a root port, a new root port is selected from among the switch ports attached to the network. The allowed range is 6 to 40 seconds.
Forwarding Delay	<p>This is the maximum time (in seconds) a switch will wait before changing states. This delay is required because every switch must receive information about topology changes before it starts to forward frames. In addition, each port needs time to listen for conflicting information that would make it return to a blocking state; otherwise, temporary data loops might result. The allowed range is 4 to 30 seconds.</p> <p>As a general rule:</p> <p>Note: $2 * (\text{Forward Delay} - 1) \geq \text{Max Age} \geq 2 * (\text{Hello Time} + 1)$</p>
Port	This field displays the port number.
Active	Select this check box to activate STP on this port.
Priority	<p>Configure the priority for each port here.</p> <p>Priority decides which port should be disabled when more than one port forms a loop in a switch. Ports with a higher priority numeric value are disabled first. The allowed range is between 0 and 255 and the default value is 128.</p>
Path Cost	Path cost is the cost of transmitting a frame on to a LAN through that port. It is assigned according to the speed of the bridge. The slower the media, the higher the cost - see Table 20 on page 93 for more information.
Apply	Click Apply to save your changes back to the switch.
Cancel	Click Cancel to begin configuring this screen afresh.

CHAPTER 12

Bandwidth Control

This chapter shows you how you can cap the maximum bandwidth using the **Bandwidth Control** screen.

12.1 Bandwidth Control Overview

Bandwidth control means defining a maximum allowable bandwidth for incoming and/or outgoing traffic flows on a port.

12.1.1 CIR and PIR

The Committed Information Rate (CIR) is the guaranteed bandwidth for the incoming traffic flow on a port. The Peak Information Rate (PIR) is the maximum bandwidth allowed for the incoming traffic flow on a port when there is no network congestion.

The CIR and PIR should be set for all ports that use the same uplink bandwidth. If the CIR is reached, packets are sent at the rate up to the PIR. When network congestion occurs, packets through the ingress port exceeding the CIR will be marked for drop.

Note: The CIR should be less than the PIR.

The sum of CIRs cannot be greater than or equal to the uplink bandwidth.

12.2 Bandwidth Control Setup

Click **Advanced Application** and then **Bandwidth Control** in the navigation panel to bring up the screen as shown next.

Figure 43 Bandwidth Control

Port	Active	Ingress Rate		Egress Rate	
		Commit Rate	Peak Rate		
1	<input type="checkbox"/>	1 Kbps	1000 Kbps	1000	Kbps
2	<input type="checkbox"/>	1 Kbps	1000 Kbps	1000	Kbps
3	<input type="checkbox"/>	1 Kbps	1000 Kbps	1000	Kbps
4	<input type="checkbox"/>	1 Kbps	1000 Kbps	1000	Kbps
5	<input type="checkbox"/>	1 Kbps	1000 Kbps	1000	Kbps
6	<input type="checkbox"/>	1 Kbps	1000 Kbps	1000	Kbps
7	<input type="checkbox"/>	1 Kbps	1000 Kbps	1000	Kbps
8	<input type="checkbox"/>	1 Kbps	1000 Kbps	1000	Kbps
9	<input type="checkbox"/>	1 Kbps	1000 Kbps	1000	Kbps
10	<input type="checkbox"/>	1 Kbps	1000 Kbps	1000	Kbps
11	<input type="checkbox"/>	1 Kbps	1000 Kbps	1000	Kbps
12	<input type="checkbox"/>	1 Kbps	1000 Kbps	1000	Kbps
13	<input type="checkbox"/>	1 Kbps	1000 Kbps	1000	Kbps
14	<input type="checkbox"/>	1 Kbps	1000 Kbps	1000	Kbps
15	<input type="checkbox"/>	1 Kbps	1000 Kbps	1000	Kbps
16	<input type="checkbox"/>	1 Kbps	1000 Kbps	1000	Kbps
17	<input type="checkbox"/>	1 Kbps	1000 Kbps	1000	Kbps
18	<input type="checkbox"/>	1 Kbps	1000 Kbps	1000	Kbps
19	<input type="checkbox"/>	1 Kbps	1000 Kbps	1000	Kbps
20	<input type="checkbox"/>	1 Kbps	1000 Kbps	1000	Kbps
21	<input type="checkbox"/>	1 Kbps	1000 Kbps	1000	Kbps
22	<input type="checkbox"/>	1 Kbps	1000 Kbps	1000	Kbps
23	<input type="checkbox"/>	1 Kbps	1000 Kbps	1000	Kbps
24	<input type="checkbox"/>	1 Kbps	1000 Kbps	1000	Kbps
25	<input type="checkbox"/>	1 Kbps	1000 Kbps	1000	Kbps
26	<input type="checkbox"/>	1 Kbps	1000 Kbps	1000	Kbps
27	<input type="checkbox"/>	1 Kbps	1000 Kbps	1000	Kbps
28	<input type="checkbox"/>	1 Kbps	1000 Kbps	1000	Kbps
29	<input type="checkbox"/>	1 Kbps	1000 Kbps	1000	Kbps
30	<input type="checkbox"/>	1 Kbps	1000 Kbps	1000	Kbps
31	<input type="checkbox"/>	1 Kbps	1000 Kbps	1000	Kbps
32	<input type="checkbox"/>	1 Kbps	1000 Kbps	1000	Kbps
33	<input type="checkbox"/>	1 Kbps	1000 Kbps	1000	Kbps
34	<input type="checkbox"/>	1 Kbps	1000 Kbps	1000	Kbps
35	<input type="checkbox"/>	1 Kbps	1000 Kbps	1000	Kbps
36	<input type="checkbox"/>	1 Kbps	1000 Kbps	1000	Kbps
37	<input type="checkbox"/>	1 Kbps	1000 Kbps	1000	Kbps
38	<input type="checkbox"/>	1 Kbps	1000 Kbps	1000	Kbps
39	<input type="checkbox"/>	1 Kbps	1000 Kbps	1000	Kbps
40	<input type="checkbox"/>	1 Kbps	1000 Kbps	1000	Kbps
41	<input type="checkbox"/>	1 Kbps	1000 Kbps	1000	Kbps
42	<input type="checkbox"/>	1 Kbps	1000 Kbps	1000	Kbps
43	<input type="checkbox"/>	1 Kbps	1000 Kbps	1000	Kbps
44	<input type="checkbox"/>	1 Kbps	1000 Kbps	1000	Kbps
45	<input type="checkbox"/>	1 Kbps	1000 Kbps	1000	Kbps
46	<input type="checkbox"/>	1 Kbps	1000 Kbps	1000	Kbps
47	<input type="checkbox"/>	1 Kbps	1000 Kbps	1000	Kbps
48	<input type="checkbox"/>	1 Kbps	1000 Kbps	1000	Kbps
49	<input type="checkbox"/>	1 Kbps	700 Kbps	1000	Kbps
50	<input type="checkbox"/>	1 Kbps	1000 Kbps	1000	Kbps
51	<input type="checkbox"/>	1 Kbps	1000 Kbps	1000	Kbps
52	<input type="checkbox"/>	1 Kbps	1000 Kbps	1000	Kbps

The following table describes the related labels in this screen.

Table 24 Bandwidth Control

LABEL	DESCRIPTION
Active	Select this check box to enable bandwidth control on the switch.
Port	This field displays the port number.

Table 24 Bandwidth Control (continued)

LABEL	DESCRIPTION
Active	Make sure to select this check box to activate bandwidth control on a port. You may temporarily deactivate a rule without deleting it by clearing this check box.
Ingress Rate	
Commit Rate	Specify the guaranteed bandwidth allowed in kilobits per second (Kbps) for the incoming traffic flow on a port. The commit rate should be less than the peak rate. The sum of commit rates cannot be greater than or equal to the uplink bandwidth.
Peak Rate	Specify the maximum bandwidth allowed in kilobits per second (Kbps) for the incoming traffic flow on a port.
Egress Rate	Specify the maximum bandwidth allowed in kilobits per second (Kbps) for the out-going traffic flow on a port.
Apply	Click Apply to save the settings.
Cancel	Click Cancel to reset the fields to your previous configuration.

CHAPTER 13

Broadcast Storm Control

This chapter introduces and shows you how to configure the broadcast storm control feature.

13.1 Overview

Broadcast storm control limits the number of broadcast, multicast and destination lookup failure (DLF) packets the switch receives per second on the ports. When the maximum number of allowable broadcast, multicast and/or DLF packets is reached per second, the subsequent packets are discarded. Enable this feature to reduce broadcast, multicast and/or DLF packets in your network. You can specify limits for each packet type on each port.

13.2 Broadcast Storm Control Setup

Click **Advanced Application, Broadcast Storm Control** in the navigation panel to display the screen as shown next.

Figure 44 Broadcast Storm Control

Broadcast Storm Control

Active

Port	Broadcast (pkt/s)	Multicast (pkt/s)	DLF (pkt/s)
1	<input type="checkbox"/> 0	<input type="checkbox"/> 0	<input type="checkbox"/> 0
2	<input type="checkbox"/> 0	<input type="checkbox"/> 0	<input type="checkbox"/> 0
3	<input type="checkbox"/> 0	<input type="checkbox"/> 0	<input type="checkbox"/> 0
4	<input type="checkbox"/> 0	<input type="checkbox"/> 0	<input type="checkbox"/> 0
5	<input type="checkbox"/> 0	<input type="checkbox"/> 0	<input type="checkbox"/> 0
6	<input type="checkbox"/> 0	<input type="checkbox"/> 0	<input type="checkbox"/> 0
7	<input type="checkbox"/> 0	<input type="checkbox"/> 0	<input type="checkbox"/> 0
8	<input type="checkbox"/> 0	<input type="checkbox"/> 0	<input type="checkbox"/> 0
9	<input type="checkbox"/> 0	<input type="checkbox"/> 0	<input type="checkbox"/> 0
10	<input type="checkbox"/> 0	<input type="checkbox"/> 0	<input type="checkbox"/> 0
11	<input type="checkbox"/> 0	<input type="checkbox"/> 0	<input type="checkbox"/> 0
12	<input type="checkbox"/> 0	<input type="checkbox"/> 0	<input type="checkbox"/> 0
13	<input type="checkbox"/> 0	<input type="checkbox"/> 0	<input type="checkbox"/> 0
14	<input type="checkbox"/> 0	<input type="checkbox"/> 0	<input type="checkbox"/> 0
15	<input type="checkbox"/> 0	<input type="checkbox"/> 0	<input type="checkbox"/> 0
16	<input type="checkbox"/> 0	<input type="checkbox"/> 0	<input type="checkbox"/> 0
17	<input type="checkbox"/> 0	<input type="checkbox"/> 0	<input type="checkbox"/> 0
18	<input type="checkbox"/> 0	<input type="checkbox"/> 0	<input type="checkbox"/> 0
19	<input type="checkbox"/> 0	<input type="checkbox"/> 0	<input type="checkbox"/> 0
20	<input type="checkbox"/> 0	<input type="checkbox"/> 0	<input type="checkbox"/> 0
21	<input type="checkbox"/> 0	<input type="checkbox"/> 0	<input type="checkbox"/> 0
22	<input type="checkbox"/> 0	<input type="checkbox"/> 0	<input type="checkbox"/> 0
23	<input type="checkbox"/> 0	<input type="checkbox"/> 0	<input type="checkbox"/> 0
24	<input type="checkbox"/> 0	<input type="checkbox"/> 0	<input type="checkbox"/> 0
25	<input type="checkbox"/> 0	<input type="checkbox"/> 0	<input type="checkbox"/> 0
26	<input type="checkbox"/> 0	<input type="checkbox"/> 0	<input type="checkbox"/> 0
27	<input type="checkbox"/> 0	<input type="checkbox"/> 0	<input type="checkbox"/> 0
28	<input type="checkbox"/> 0	<input type="checkbox"/> 0	<input type="checkbox"/> 0
29	<input type="checkbox"/> 0	<input type="checkbox"/> 0	<input type="checkbox"/> 0
30	<input type="checkbox"/> 0	<input type="checkbox"/> 0	<input type="checkbox"/> 0
31	<input type="checkbox"/> 0	<input type="checkbox"/> 0	<input type="checkbox"/> 0
32	<input type="checkbox"/> 0	<input type="checkbox"/> 0	<input type="checkbox"/> 0
33	<input type="checkbox"/> 0	<input type="checkbox"/> 0	<input type="checkbox"/> 0
34	<input type="checkbox"/> 0	<input type="checkbox"/> 0	<input type="checkbox"/> 0
35	<input type="checkbox"/> 0	<input type="checkbox"/> 0	<input type="checkbox"/> 0
36	<input type="checkbox"/> 0	<input type="checkbox"/> 0	<input type="checkbox"/> 0
37	<input type="checkbox"/> 0	<input type="checkbox"/> 0	<input type="checkbox"/> 0
38	<input type="checkbox"/> 0	<input type="checkbox"/> 0	<input type="checkbox"/> 0
39	<input type="checkbox"/> 0	<input type="checkbox"/> 0	<input type="checkbox"/> 0
40	<input type="checkbox"/> 0	<input type="checkbox"/> 0	<input type="checkbox"/> 0
41	<input type="checkbox"/> 0	<input type="checkbox"/> 0	<input type="checkbox"/> 0
42	<input type="checkbox"/> 0	<input type="checkbox"/> 0	<input type="checkbox"/> 0
43	<input type="checkbox"/> 0	<input type="checkbox"/> 0	<input type="checkbox"/> 0
44	<input type="checkbox"/> 0	<input type="checkbox"/> 0	<input type="checkbox"/> 0
45	<input type="checkbox"/> 0	<input type="checkbox"/> 0	<input type="checkbox"/> 0
46	<input type="checkbox"/> 0	<input type="checkbox"/> 0	<input type="checkbox"/> 0
47	<input type="checkbox"/> 0	<input type="checkbox"/> 0	<input type="checkbox"/> 0
48	<input type="checkbox"/> 0	<input type="checkbox"/> 0	<input type="checkbox"/> 0
49	<input type="checkbox"/> 0	<input type="checkbox"/> 0	<input type="checkbox"/> 0
50	<input type="checkbox"/> 0	<input type="checkbox"/> 0	<input type="checkbox"/> 0
51	<input type="checkbox"/> 0	<input type="checkbox"/> 0	<input type="checkbox"/> 0
52	<input type="checkbox"/> 0	<input type="checkbox"/> 0	<input type="checkbox"/> 0

The following table describes the labels in this screen.

Table 25 Broadcast Storm Control

LABEL	DESCRIPTION
Active	Select this check box to enable traffic storm control on the switch. Clear this check box to disable this feature.
Port	This field displays a port number.
Broadcast (pkt/s)	Select this option and specify how many broadcast packets the port receives per second.
Multicast (pkt/s)	Select this option and specify how many multicast packets the port receives per second.
DLF (pkt/s)	Select this option and specify how many destination lookup failure (DLF) packets the port receives per second.
Apply	Click Apply to save your changes back to the switch.
Cancel	Click Cancel to begin configuring this screen afresh.

CHAPTER 14

Mirroring

This chapter discusses the Mirror setup screens.

14.1 Introduction to Port Mirroring

Port mirroring allows you to copy a traffic flow to a monitor port (the port you copy the traffic to) in order that you can examine the traffic from the monitor port without interference.

14.2 Port Mirroring Setup

Click **Advanced Application, Mirroring** in the navigation panel to display the **Mirroring** screen. Use this screen to select a monitor port and specify the traffic flow to be copied to the monitor port.

Figure 45 Mirroring

Mirroring

Active

Monitor Port
Port 1 ▾

Port	Mirrored	Direction
1	<input type="checkbox"/>	Ingress ▾
2	<input type="checkbox"/>	Ingress ▾
3	<input type="checkbox"/>	Ingress ▾
4	<input type="checkbox"/>	Ingress ▾
5	<input type="checkbox"/>	Ingress ▾
6	<input type="checkbox"/>	Ingress ▾
7	<input type="checkbox"/>	Ingress ▾
8	<input type="checkbox"/>	Ingress ▾
9	<input type="checkbox"/>	Ingress ▾
10	<input type="checkbox"/>	Ingress ▾
11	<input type="checkbox"/>	Ingress ▾
12	<input type="checkbox"/>	Ingress ▾
13	<input type="checkbox"/>	Ingress ▾
14	<input type="checkbox"/>	Ingress ▾
15	<input type="checkbox"/>	Ingress ▾
16	<input type="checkbox"/>	Ingress ▾
17	<input type="checkbox"/>	Ingress ▾
18	<input type="checkbox"/>	Ingress ▾
19	<input type="checkbox"/>	Ingress ▾
20	<input type="checkbox"/>	Ingress ▾
41	<input type="checkbox"/>	Ingress ▾
44	<input type="checkbox"/>	Ingress ▾
45	<input type="checkbox"/>	Ingress ▾
46	<input type="checkbox"/>	Ingress ▾
47	<input type="checkbox"/>	Ingress ▾
48	<input type="checkbox"/>	Ingress ▾
49	<input type="checkbox"/>	Ingress ▾
50	<input type="checkbox"/>	Ingress ▾
51	<input type="checkbox"/>	Ingress ▾
52	<input type="checkbox"/>	Ingress ▾

Apply Cancel

The following table describes the labels in this screen.

Table 26 Mirroring

LABEL	DESCRIPTION
Active	Select this check box to activate port mirroring on the switch. Clear this check box to disable the feature.
Monitor Port	The monitor port is the port you copy the traffic to in order to examine it in more detail without interfering with the traffic flow on the original port(s). Select a port from the drop-down list box.
Port	This field displays the port number.
Mirrored	Select this option to mirror the traffic on a port.
Direction	Specify the direction of the traffic to mirror by selecting from the drop-down list box. Choices are Egress (outgoing), Ingress (incoming) and Both .
Apply	Click Apply to save the changes.
Cancel	Click Cancel to start configuring the screen again.

CHAPTER 15

Link Aggregation

This chapter shows you how to logically aggregate physical links to form one logical, higher-bandwidth link.

15.1 Introduction to Link Aggregation

Link aggregation (trunking) is the grouping of physical ports into one logical higher-capacity link. You may want to trunk ports if for example, it is cheaper to use multiple lower-speed links than to under-utilize a high-speed, but more costly, single-port link.

However, the more ports you aggregate then the fewer available ports you have. A trunk group is one logical link containing multiple ports.

The beginning port of each trunk group must be physically connected to form a trunk group.

15.2 Dynamic Link Aggregation

The switch adheres to the IEEE 802.3ad standard for static and dynamic (LACP) port trunking.

The switch supports the link aggregation IEEE802.3ad standard. This standard describes the Link Aggregate Control Protocol (LACP), which is a protocol that dynamically creates and manages trunk groups.

When you enable LACP link aggregation on a port, the port can automatically negotiate with the ports at the remote end of a link to establish trunk groups. LACP also allows port redundancy, that is, if an operational port fails, then one of the “standby” ports become operational without user intervention. Please note that:

- You must connect all ports point-to-point to the same Ethernet switch and configure the ports for LACP trunking.
- LACP only works on full-duplex links.
- All ports in the same trunk group must have the same media type, speed, duplex mode and flow control settings.

Configure trunk groups or LACP before you connect the Ethernet switch to avoid causing network topology loops.

15.2.1 Link Aggregation ID

LACP aggregation ID consists of the following information¹:

Table 27 Link Aggregation ID: Local Switch

SYSTEM PRIORITY	MAC ADDRESS	KEY	PORT PRIORITY	PORT NUMBER
0000	00-00-00-00-00	0000	00	0000

Table 28 Link Aggregation ID: Peer Switch

SYSTEM PRIORITY	MAC ADDRESS	KEY	PORT PRIORITY	PORT NUMBER
0000	00-00-00-00-00	0000	00	0000

15.3 Link Aggregation Status

Click **Advanced Application**, **Link Aggregation** in the navigation panel. The **Link Aggregation Control Protocol Status** screen displays by default.

Figure 46 Link Aggregation Control Protocol Status

Index	Aggregator ID	Enabled Ports	Synchronized Ports
1	[(0000,00-00-00-00-00-00,0000,00,0000)] [(0000,00-00-00-00-00-00,0000,00,0000)]	-	-
2	[(0000,00-00-00-00-00-00,0000,00,0000)] [(0000,00-00-00-00-00-00,0000,00,0000)]	-	-
3	[(0000,00-00-00-00-00-00,0000,00,0000)] [(0000,00-00-00-00-00-00,0000,00,0000)]	-	-
4	[(0000,00-00-00-00-00-00,0000,00,0000)] [(0000,00-00-00-00-00-00,0000,00,0000)]	-	-
5	[(0000,00-00-00-00-00-00,0000,00,0000)] [(0000,00-00-00-00-00-00,0000,00,0000)]	-	-
6	[(0000,00-00-00-00-00-00,0000,00,0000)] [(0000,00-00-00-00-00-00,0000,00,0000)]	-	-

Polling Interval(s)

1. Port Priority and Port Number are 0 as it is the aggregator ID for the trunk group, not the individual port.

The following table describes the labels in this screen.

Table 29 Link Aggregation Control Protocol Status

LABEL	DESCRIPTION
Index	This field displays the trunk ID to identify a trunk group, that is, one logical link containing multiple ports.
Aggregator ID	Refer to Section 15.2.1 on page 112 for more information on this field.
Enabled Port	These are the ports you have configured in the Link Aggregation screen to be in the trunk group.
Synchronized Ports	These are the ports that are currently transmitting data as one logical link in this trunk group.
Polling Interval(s)	The text box displays how often (in seconds) this screen refreshes. You may change the refresh interval by typing a new number in the text box and then clicking Set Interval .
Stop	Click Stop to halt statistic polling.

15.4 Link Aggregation Setup

Click **Configuration** in the **Link Aggregation Control Protocol Status** screen to display the screen shown next.

Figure 47 Link Aggregation: Configuration

Link Aggregation
Status

Link Aggregation Control Protocol

Active

System Priority

Group ID	Active	Dynamic(LACP)
T1	<input type="checkbox"/>	<input type="checkbox"/>
T2	<input type="checkbox"/>	<input type="checkbox"/>
T3	<input type="checkbox"/>	<input type="checkbox"/>
T4	<input type="checkbox"/>	<input type="checkbox"/>
T5	<input type="checkbox"/>	<input type="checkbox"/>
T6	<input type="checkbox"/>	<input type="checkbox"/>

Port	Group	LACP Timeout
1	None	30 seconds
2	None	30 seconds
3	None	30 seconds
4	None	30 seconds
5	None	30 seconds
6	None	30 seconds
7	None	30 seconds
8	None	30 seconds
9	None	30 seconds
10	None	30 seconds
11	None	30 seconds
12	None	30 seconds
13	None	30 seconds
14	None	30 seconds
15	None	30 seconds
16	None	30 seconds
17	None	30 seconds
18	None	30 seconds
19	None	30 seconds
41	None	30 seconds
42	None	30 seconds
43	None	30 seconds
44	None	30 seconds
45	None	30 seconds
46	None	30 seconds
47	None	30 seconds
48	None	30 seconds
49	None	30 seconds
50	None	30 seconds
51	None	30 seconds
52	None	30 seconds

The following table describes the labels in this screen.

Table 30 Link Aggregation Control Protocol: Configuration

LABEL	DESCRIPTION
Link Aggregation Control Protocol	
Active	Select this checkbox to enable Link Aggregation Control Protocol (LACP).
System Priority	LACP system priority is a number between 1 and 65,535. The switch with the lowest system priority (and lowest port number if system priority is the same) becomes the LACP "server". The LACP "server" controls the operation of LACP setup. Enter a number to set the priority of an active port using Link Aggregate Control Protocol (LACP). The smaller the number, the higher the priority level.
Group ID	The field identifies the link aggregation group, that is, one logical link containing multiple ports.
Active	Select this option to activate a trunk group.
Dynamic (LACP)	Select this check box to enable LACP for a trunk.
Port	This field displays the port number.
Group	Select the trunk group to which a port belongs.
LACP Timeout	Timeout is the time interval between the individual port exchanges of LACP packets in order to check that the peer port in the trunk group is still up. If a port does not respond after three tries, then it is deemed to be "down" and is removed from the trunk. Set a short timeout (one second) for busy trunked links to ensure that disabled ports are removed from the trunk group as soon as possible. Select either 1 second or 30 seconds.
Apply	Click Apply to save your changes back to the switch.
Cancel	Click Cancel to begin configuring this screen afresh.

CHAPTER 16

Port Authentication

This chapter describes the 802.1x authentication method and RADIUS server connection setup.

16.1 Introduction to Authentication

IEEE 802.1x is an extended authentication protocol² that allows support of RADIUS (Remote Authentication Dial In User Service, RFC 2138, 2139) for centralized user profile and accounting management on a network RADIUS server.

16.1.1 RADIUS

RADIUS (Remote Authentication Dial-In User Service) authentication is a popular protocol used to authenticate users by means of an external server instead of (or in addition to) an internal device user database that is limited to the memory capacity of the device. In essence, RADIUS authentication allows you to validate an unlimited number of users from a central location.

Figure 48 RADIUS Server

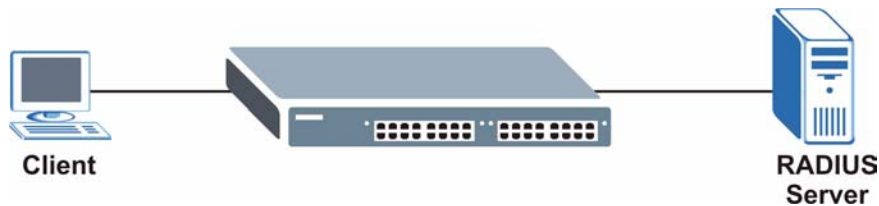

16.2 Port Authentication Configuration

To enable port authentication, first activate IEEE802.1x security (both on the switch and the port(s)) then configure the RADIUS server settings.

Click **Advanced Application, Port Authentication** in the navigation panel to display the screen as shown.

-
2. At the time of writing, only Windows XP of the Microsoft operating systems supports it. See the Microsoft web site for information on other Windows operating system support. For other operating systems, see its documentation. If your operating system does not support 802.1x, then you may need to install 802.1x client software.

Figure 49 Port Authentication

16.2.1 Configuring RADIUS Server Settings

From the **Port Authentication** screen, click **RADIUS** to display the configuration screen as shown.

Figure 50 Port Authentication: RADIUS

The following table describes the labels in this screen.

Table 31 Port Authentication: RADIUS

LABEL	DESCRIPTION
Authentication Server	
IP Address	Enter the IP address of the external RADIUS server in dotted decimal notation.
UDP Port	The default port of the RADIUS server for authentication is 1812 . You need not change this value unless your network administrator instructs you to do so.
Shared Secret	Specify a password (up to 32 alphanumeric characters) as the key to be shared between the external RADIUS server and the switch. This key is not sent over the network. This key must be the same on the external RADIUS server and the switch.
Apply	Click Apply to save your changes back to the switch.
Cancel	Click Cancel to begin configuring this screen afresh.

16.2.2 Activate IEEE 802.1x Security

From the **Port Authentication** screen, display the configuration screen as shown.

Figure 51 Port Authentication: 802.1x

802.1x
Port Authentication

Active

Port	Active	Reauthentication	Reauthentication Timer
1	<input type="checkbox"/>	On ▼	3600 seconds
2	<input type="checkbox"/>	On ▼	3600 seconds
3	<input type="checkbox"/>	On ▼	3600 seconds
4	<input type="checkbox"/>	On ▼	3600 seconds
5	<input type="checkbox"/>	On ▼	3600 seconds
6	<input type="checkbox"/>	On ▼	3600 seconds
7	<input type="checkbox"/>	On ▼	3600 seconds
8	<input type="checkbox"/>	On ▼	3600 seconds
9	<input type="checkbox"/>	On ▼	3600 seconds
10	<input type="checkbox"/>	On ▼	3600 seconds
11	<input type="checkbox"/>	On ▼	3600 seconds
12	<input type="checkbox"/>	On ▼	3600 seconds
13	<input type="checkbox"/>	On ▼	3600 seconds
14	<input type="checkbox"/>	On ▼	3600 seconds
15	<input type="checkbox"/>	On ▼	3600 seconds
16	<input type="checkbox"/>	On ▼	3600 seconds
17	<input type="checkbox"/>	On ▼	3600 seconds
18	<input type="checkbox"/>	On ▼	3600 seconds
19	<input type="checkbox"/>	On ▼	3600 seconds
20	<input type="checkbox"/>	On ▼	3600 seconds
42	<input type="checkbox"/>	On ▼	3600 seconds
43	<input type="checkbox"/>	On ▼	3600 seconds
44	<input type="checkbox"/>	On ▼	3600 seconds
45	<input type="checkbox"/>	On ▼	3600 seconds
46	<input type="checkbox"/>	On ▼	3600 seconds
47	<input type="checkbox"/>	On ▼	3600 seconds
48	<input type="checkbox"/>	On ▼	3600 seconds
49	<input type="checkbox"/>	On ▼	3600 seconds
50	<input type="checkbox"/>	On ▼	3600 seconds
51	<input type="checkbox"/>	On ▼	3600 seconds
52	<input type="checkbox"/>	On ▼	3600 seconds

Apply
Cancel

The following table describes the labels in this screen.

Table 32 Port Authentication: 802.1x

LABEL	DESCRIPTION
Active	Select this check box to permit 802.1x authentication on the switch. Note: You must first enable 802.1x authentication on the switch before configuring it on each port.
Port	This field displays a port number.
Active	Select this checkbox to permit 802.1x authentication on this port. You must first allow 802.1x authentication on the switch before configuring it on each port.
Reauthentication	Specify if a subscriber has to periodically re-enter his or her username and password to stay connected to the port.
Reauthentication Timer	Specify how often a client has to re-enter his or her username and password to stay connected to the port.
Apply	Click Apply to save your changes back to the switch.
Cancel	Click Cancel to begin configuring this screen afresh.

CHAPTER 17

Port Security

This chapter shows you how to set up port security.

17.1 About Port Security

Port security allows only packets with dynamically learned MAC addresses and/or configured static MAC addresses to pass through a port on the switch. The switch can learn up to 16K MAC addresses in total with no limit on individual ports other than the sum cannot exceed 16K.

For maximum port security, enable this feature, disable MAC address learning and configure static MAC address(es) for a port. It is not recommended you disable port security together with MAC address learning as this will result in many broadcasts. By default, MAC address learning is still enabled even though the port security is not activated.

17.2 Port Security Setup

Click **Advanced Application, Port Security** in the navigation panel to display the screen as shown.

Figure 52 Port Security

Port Security

Active

Port	Active	Address Learning	Limited Number of Learned MAC Address
1	<input type="checkbox"/>	<input checked="" type="checkbox"/>	0
2	<input type="checkbox"/>	<input checked="" type="checkbox"/>	0
3	<input type="checkbox"/>	<input checked="" type="checkbox"/>	0
4	<input type="checkbox"/>	<input checked="" type="checkbox"/>	0
5	<input type="checkbox"/>	<input checked="" type="checkbox"/>	0
6	<input type="checkbox"/>	<input checked="" type="checkbox"/>	0
7	<input type="checkbox"/>	<input checked="" type="checkbox"/>	0
8	<input type="checkbox"/>	<input checked="" type="checkbox"/>	0
9	<input type="checkbox"/>	<input checked="" type="checkbox"/>	0
10	<input type="checkbox"/>	<input checked="" type="checkbox"/>	0
11	<input type="checkbox"/>	<input checked="" type="checkbox"/>	0
12	<input type="checkbox"/>	<input checked="" type="checkbox"/>	0
13	<input type="checkbox"/>	<input checked="" type="checkbox"/>	0
14	<input type="checkbox"/>	<input checked="" type="checkbox"/>	0
15	<input type="checkbox"/>	<input checked="" type="checkbox"/>	0
16	<input type="checkbox"/>	<input checked="" type="checkbox"/>	0
17	<input type="checkbox"/>	<input checked="" type="checkbox"/>	0
18	<input type="checkbox"/>	<input checked="" type="checkbox"/>	0
19	<input type="checkbox"/>	<input checked="" type="checkbox"/>	0
20	<input type="checkbox"/>	<input checked="" type="checkbox"/>	0
21	<input type="checkbox"/>	<input checked="" type="checkbox"/>	0
22	<input type="checkbox"/>	<input checked="" type="checkbox"/>	0
23	<input type="checkbox"/>	<input checked="" type="checkbox"/>	0
24	<input type="checkbox"/>	<input checked="" type="checkbox"/>	0
25	<input type="checkbox"/>	<input checked="" type="checkbox"/>	0
26	<input type="checkbox"/>	<input checked="" type="checkbox"/>	0
27	<input type="checkbox"/>	<input checked="" type="checkbox"/>	0
28	<input type="checkbox"/>	<input checked="" type="checkbox"/>	0
29	<input type="checkbox"/>	<input checked="" type="checkbox"/>	0
30	<input type="checkbox"/>	<input checked="" type="checkbox"/>	0
31	<input type="checkbox"/>	<input checked="" type="checkbox"/>	0
32	<input type="checkbox"/>	<input checked="" type="checkbox"/>	0
33	<input type="checkbox"/>	<input checked="" type="checkbox"/>	0
34	<input type="checkbox"/>	<input checked="" type="checkbox"/>	0
35	<input type="checkbox"/>	<input checked="" type="checkbox"/>	0
36	<input type="checkbox"/>	<input checked="" type="checkbox"/>	0
37	<input type="checkbox"/>	<input checked="" type="checkbox"/>	0
38	<input type="checkbox"/>	<input checked="" type="checkbox"/>	0
39	<input type="checkbox"/>	<input checked="" type="checkbox"/>	0
40	<input type="checkbox"/>	<input checked="" type="checkbox"/>	0
41	<input type="checkbox"/>	<input checked="" type="checkbox"/>	0
42	<input type="checkbox"/>	<input checked="" type="checkbox"/>	0
43	<input type="checkbox"/>	<input checked="" type="checkbox"/>	0
44	<input type="checkbox"/>	<input checked="" type="checkbox"/>	0
45	<input type="checkbox"/>	<input checked="" type="checkbox"/>	0
46	<input type="checkbox"/>	<input checked="" type="checkbox"/>	0
47	<input type="checkbox"/>	<input checked="" type="checkbox"/>	0
48	<input type="checkbox"/>	<input checked="" type="checkbox"/>	0
49	<input type="checkbox"/>	<input checked="" type="checkbox"/>	0
50	<input type="checkbox"/>	<input checked="" type="checkbox"/>	0
51	<input type="checkbox"/>	<input checked="" type="checkbox"/>	0
52	<input type="checkbox"/>	<input checked="" type="checkbox"/>	0

The following table describes the labels in this screen.

Table 33 Port Security

LABEL	DESCRIPTION
Active	Select this option to enable port security on the switch.
Port	This field displays a port number.
Active	Select this check box to enable the port security feature on this port. The switch forwards packets whose MAC address(es) is in the MAC address table on this port. Packets with no matching MAC address(es) are dropped. Clear this check box to disable the port security feature. The switch forwards all packets on this port.
Address Learning	MAC address learning reduces outgoing broadcast traffic. For MAC address learning to occur on a port, the port itself must be active with address learning enabled.
Limited Number of Learned MAC Address	Use this field to limit the number of (dynamic) MAC addresses that may be learned on a port. For example, if you set this field to "5" on port 2, then only the devices with these five learned MAC addresses may access port 2 at any one time. A sixth device would have to wait until one of the five learned MAC addresses aged out. MAC address aging out time can be set in the Switch Setup screen. The valid range is from "0" to "254". "0" means this feature is disabled.
Apply	Click Apply to save your changes back to the switch.
Cancel	Click Cancel to begin configuring this screen afresh.

CHAPTER 18

Access Control

This chapter describes how to control access to the switch.

18.1 Overview

- A console port access control session and Telnet access control session cannot coexist. The console port has higher priority. If you telnet to the switch and someone is already logged in from the console port, then you will see the following message.

Figure 53 Console Port Priority

```
"Local administrator is configuring this device now!!!
Connection to host lost."
```

- A console port or Telnet session can coexist with one FTP session, up to five Web sessions (five different usernames and passwords) and/or limitless SNMP access control sessions.

Table 34 Access Control Overview

Console Port	SSH	Telnet	FTP	Web	SNMP
The console port, SSH and Telnet share one session. The Console port has the highest priority and Telnet has the lowest priority.			One session	Up to five accounts	No limit

18.2 The Access Control Main Screen

Click **Management, Access Control** in the navigation panel to display the main screen as shown.

Figure 54 Access Control



18.3 About SNMP

Simple Network Management Protocol (SNMP) is an application layer protocol used to manage and monitor TCP/IP-based devices. SNMP is used to exchange management information between the network management system (NMS) and a network element (NE). A manager station can manage and monitor the switch through the network via SNMP version one (SNMPv1) and/or SNMP version 2c. The next figure illustrates an SNMP management operation. SNMP is only available if TCP/IP is configured.

Figure 55 SNMP Management Model

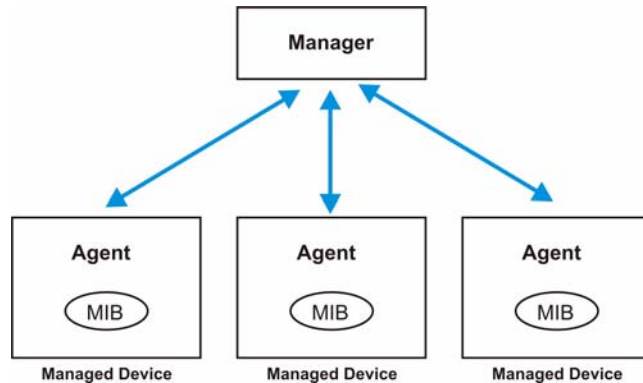

An SNMP managed network consists of two main components: agents and a manager.

An agent is a management software module that resides in a managed switch (the switch). An agent translates the local management information from the managed switch into a form compatible with SNMP. The manager is the console through which network administrators perform network management functions. It executes applications that control and monitor managed devices.

The managed devices contain object variables/managed objects that define each piece of information to be collected about a switch. Examples of variables include such as number of packets received, node port status etc. A Management Information Base (MIB) is a collection of managed objects. SNMP allows a manager and agents to communicate for the purpose of accessing these objects.

SNMP itself is a simple request/response protocol based on the manager/agent model. The manager issues a request and the agent returns responses using the following protocol operations:

Table 35 SNMP Commands

COMMAND	DESCRIPTION
Get	Allows the manager to retrieve an object variable from the agent.
GetNext	Allows the manager to retrieve the next object variable from a table or list within an agent. In SNMPv1, when a manager wants to retrieve all elements of a table from an agent, it initiates a Get operation, followed by a series of GetNext operations.

Table 35 SNMP Commands

COMMAND	DESCRIPTION
Set	Allows the manager to set values for object variables within an agent.
Trap	Used by the agent to inform the manager of some events.

18.3.1 Supported MIBs

MIBs let administrators collect statistics and monitor status and performance.

The switch supports the following MIBs:

- SNMP MIB II (RFC 1213)
- RFC 1157 SNMP v1
- RFC 1493 Bridge MIBs
- RFC 1643 Ethernet MIBs
- RFC 1155 SMI
- RFC 2674 SNMPv2, SNMPv2c
- RFC 1757 RMON
- SNMPv2, SNMPv2c or later version, compliant with RFC 2011 SNMPv2 MIB for IP, RFC 2012 SNMPv2 MIB for TCP, RFC 2013 SNMPv2 MIB for UDP

18.3.2 SNMP Traps

The switch sends traps to an SNMP manager when an event occurs. SNMP traps supported are outlined in the following table.

Table 36 SNMP Traps

GENERIC TRAP	SPECIFIC TRAP	DESCRIPTION
0 (Cold Start)	0	This trap is sent when the switch is turned on.
1 (WarmStart)	0	This trap is sent when the switch restarts.
2 (linkDown)	0	This trap is sent when the Ethernet link is down.
3 (linkUp)	0	This trap is sent when the Ethernet link is up.
4 (authenticationFailure)	0	This trap is sent when an SNMP request comes from non-authenticated hosts.

18.3.3 Configuring SNMP

From the **Access Control** screen, display the **SNMP** screen. You can click **Access Control** to go back to the **Access Control** screen.

Figure 56 Access Control: SNMP

The following table describes the labels in this screen.

Table 37 Access Control: SNMP

LABEL	DESCRIPTION
Get Community	Enter the get community, which is the password for the incoming Get- and GetNext-requests from the management station.
Set Community	Enter the set community, which is the password for incoming Set- requests from the management station.
Trap Community	Enter the trap community, which is the password sent with each trap to the SNMP manager.
Trap Destination	Enter the IP addresses of up to four stations to send your SNMP traps to.
Apply	Click Apply to save your changes back to the switch.
Cancel	Click Cancel to begin configuring this screen afresh.

18.3.4 Setting Up Login Accounts

Up to five people (one administrator and four non-administrators) may access the switch via web configurator at any one time.

- An administrator is someone who can both view and configure switch changes. The username for the Administrator is always **admin**. The default administrator password is **1234**.

Note: It is highly recommended that you change the default administrator password (**1234**).

- A non-administrator (username is something other than **admin**) is someone who can view but not configure switch settings.

Click **Access Control** from the navigation panel and then click **Logins** from this screen.

Figure 57 Access Control: Logins

Logins Access Control

Administrator

Old Password

New Password

Retype to confirm

Please record your new password whenever you change it. The system will lock you out if you have forgotten your password.

Edit Logins

Login	User Name	Password	Retype to confirm
1	<input type="text"/>	<input type="text"/>	<input type="text"/>
2	<input type="text"/>	<input type="text"/>	<input type="text"/>
3	<input type="text"/>	<input type="text"/>	<input type="text"/>
4	<input type="text"/>	<input type="text"/>	<input type="text"/>

Apply Cancel

The following table describes the labels in this screen.

Table 38 Access Control: Logins

LABEL	DESCRIPTION
Administrator	This is the default administrator account with the "admin" user name. You cannot change the default administrator user name. Only the administrator has read/write access.
Old Password	Type the existing system password (1234 is the default password when shipped).
New Password	Enter your new system password.
Retype to confirm	Retype your new system password for confirmation
Edit Logins	You may configure passwords for up to four users. These people have read-only access.
User Name	Set a user name (up to 32 ASCII characters long).
Password	Enter your new system password.
Retype to confirm	Retype your new system password for confirmation
Apply	Click Apply to save your changes back to the switch.
Cancel	Click Cancel to begin configuring this screen afresh.

18.4 SSH Overview

Unlike Telnet or FTP, which transmit data in clear text, SSH (Secure Shell) is a secure communication protocol that combines authentication and data encryption to provide secure encrypted communication

between two hosts over an unsecured network.

Figure 58 SSH Communication Example



18.5 How SSH works

The following table summarizes how a secure connection is established between two remote hosts.

Figure 59 How SSH Works

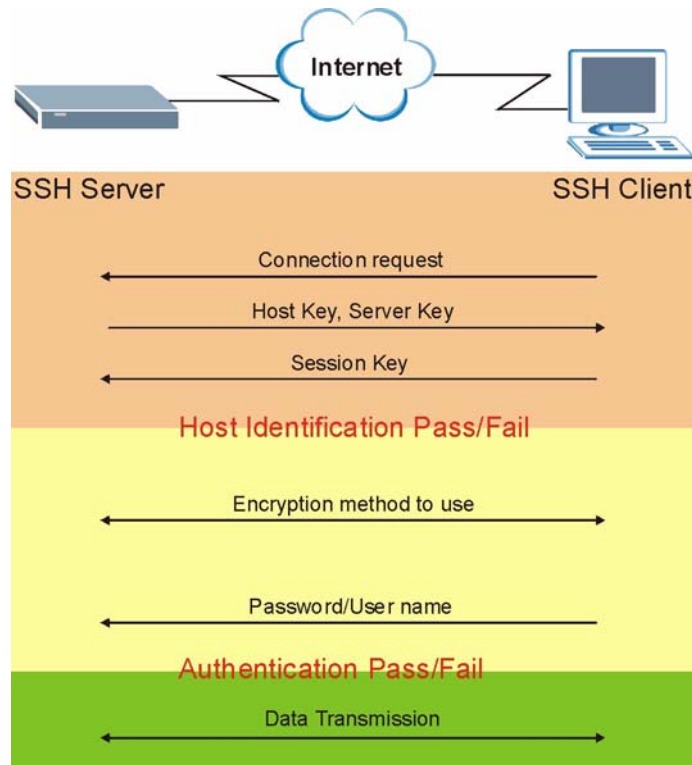

1 Host Identification

The SSH client sends a connection request to the SSH server. The server identifies itself with a host key. The client encrypts a randomly generated session key with the host key and server key and sends the result back to the server.

The client automatically saves any new server public keys. In subsequent connections, the server public key is checked against the saved version on the client computer.

2 Encryption Method

Once the identification is verified, both the client and server must agree on the type of encryption method to use.

3 Authentication and Data Transmission

After the identification is verified and data encryption activated, a secure tunnel is established between the client and the server. The client then sends its authentication information (user name and password) to the server to log in to the server.

18.6 SSH Implementation on the Switch

Your switch supports SSH version 2 using RSA authentication and three encryption methods (DES, 3DES and Blowfish). The SSH server is implemented on the switch for remote management and file transfer on port 22. Only one SSH connection is allowed at a time.

18.6.1 Requirements for Using SSH

You must install an SSH client program on a client computer (Windows or Linux operating system) that is used to connect to the switch over SSH.

18.7 Introduction to HTTPS

HTTPS (HyperText Transfer Protocol over Secure Socket Layer, or HTTP over SSL) is a web protocol that encrypts and decrypts web pages. Secure Socket Layer (SSL) is an application-level protocol that enables secure transactions of data by ensuring confidentiality (an unauthorized party cannot read the transferred data), authentication (one party can identify the other party) and data integrity (you know if data has been changed).

It relies upon certificates, public keys, and private keys.

HTTPS on the switch is used so that you may securely access the switch using the web configurator. The SSL protocol specifies that the SSL server (the switch) must always authenticate itself to the SSL client (the computer which requests the HTTPS connection with the switch), whereas the SSL client only should authenticate itself when the SSL server requires it to do so. Authenticating client certificates is optional and if selected means the SSL-client must send the switch a certificate. You must apply for a certificate for the browser from a CA that is a trusted CA on the switch.

Please refer to the following figure.

- 1** HTTPS connection requests from an SSL-aware web browser go to port 443 (by default) on the switch's WS (web server).

- 2 HTTP connection requests from a web browser go to port 80 (by default) on the switch's WS (web server).

Figure 60 HTTPS Implementation

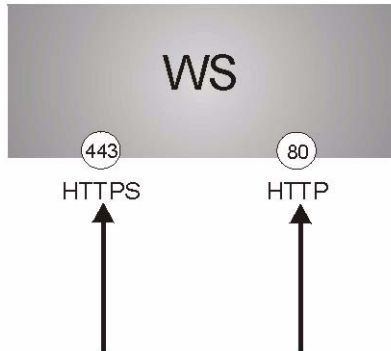

Note: If you disable **HTTP** in the **Service Access Control** screen, then the switch blocks all HTTP connection attempts.

18.8 HTTPS Example

If you haven't changed the default HTTPS port on the switch, then in your browser enter "https://switch IP Address/" as the web site address where "switch IP Address" is the IP address or domain name of the switch you wish to access.

18.8.1 Internet Explorer Warning Messages

When you attempt to access the switch HTTPS server, a Windows dialog box pops up asking if you trust the server certificate. Click **View Certificate** if you want to verify that the certificate is from the switch.

You see the following **Security Alert** screen in Internet Explorer. Select **Yes** to proceed to the web configurator login screen; if you select **No**, then web configurator access is blocked.

Figure 61 Security Alert Dialog Box (Internet Explorer)

18.8.2 Netscape Navigator Warning Messages

When you attempt to access the switch HTTPS server, a **Website Certified by an Unknown Authority** screen pops up asking if you trust the server certificate. Click **Examine Certificate** if you want to verify that the certificate is from the switch.

If **Accept this certificate temporarily for this session** is selected, then click **OK** to continue in Netscape.

Select **Accept this certificate permanently** to import the switch's certificate into the SSL client.

Figure 62 Security Certificate 1 (Netscape)

Figure 63 Security Certificate 2 (Netscape)



18.8.3 The Main Screen

After you accept the certificate and enter the login username and password, the switch main screen appears. The lock displayed in the bottom right of the browser status bar denotes a secure connection.

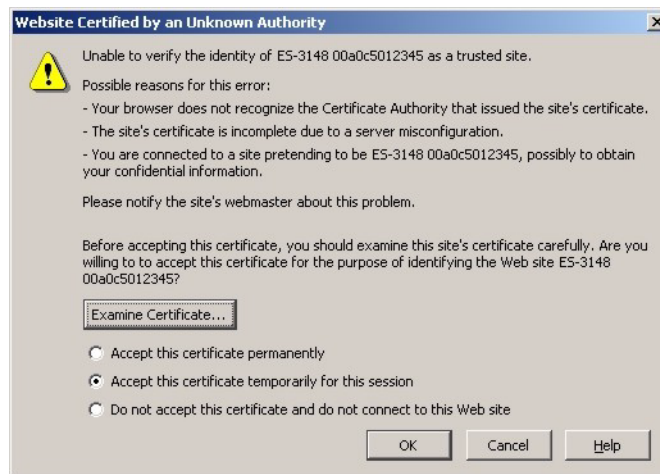
Figure 64 Login Screen (Internet Explorer)

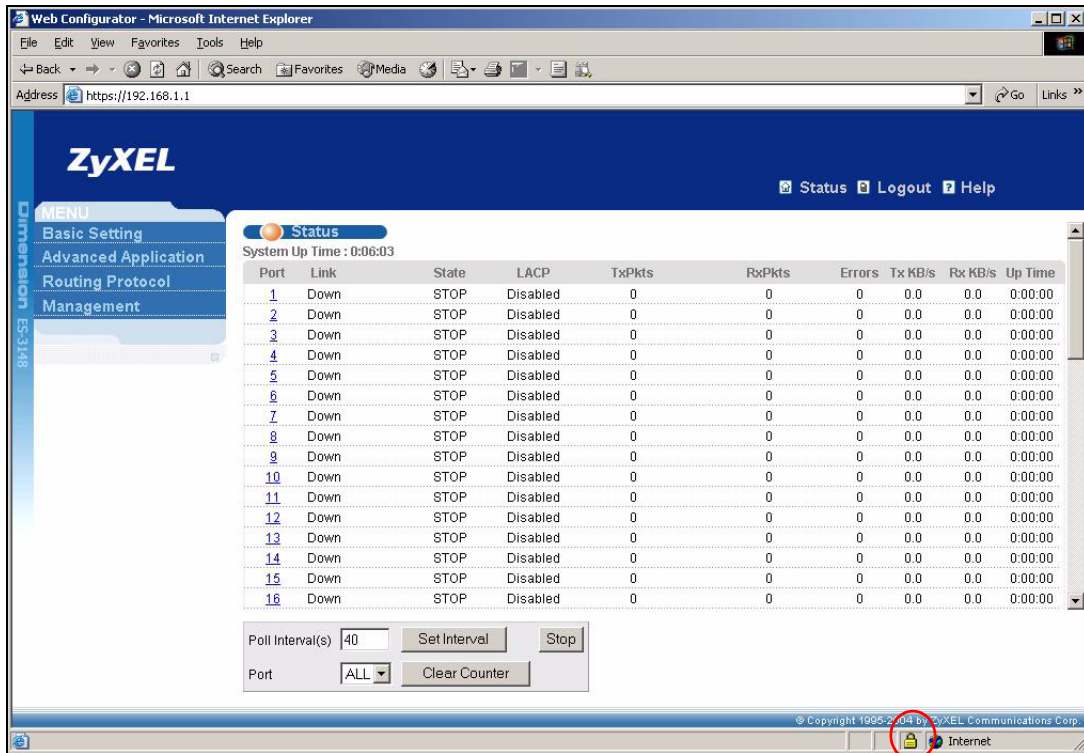
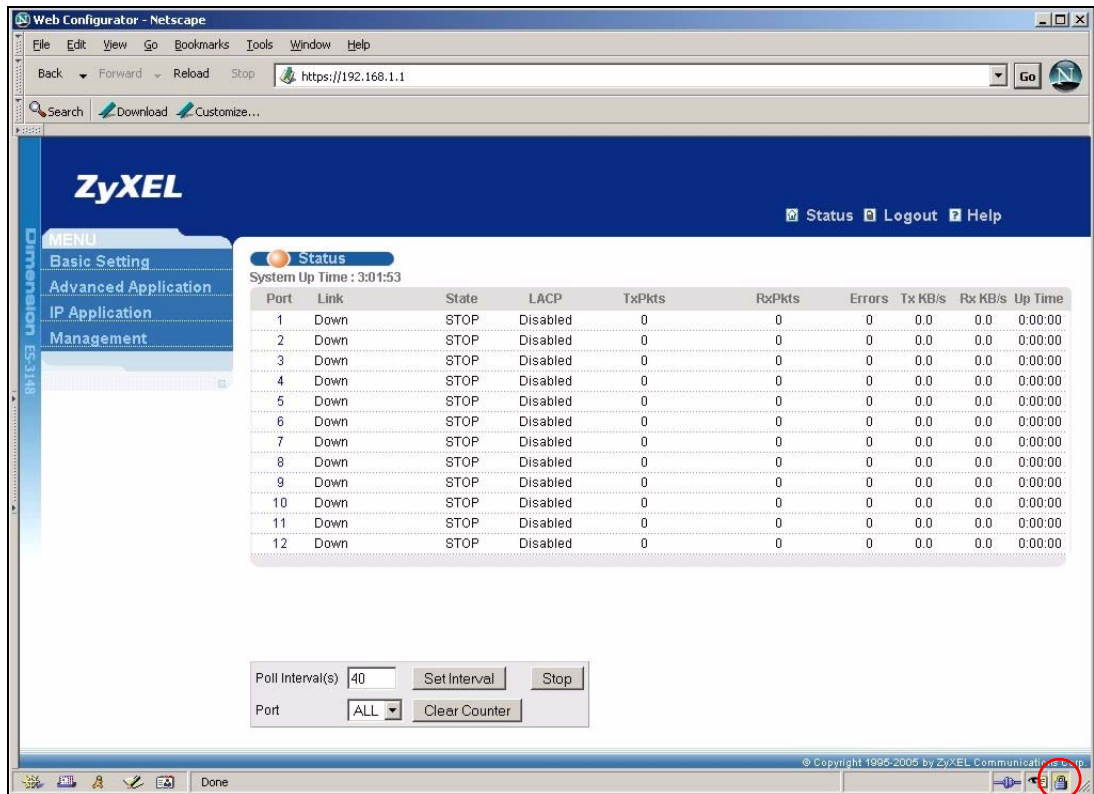

Figure 65 Login Screen (Netscape)



18.9 Service Port Access Control

Service Access Control allows you to decide what services you may use to access the switch. You may also change the default service port and configure “trusted computer(s)” for each service in the **Remote Management** screen (discussed later). Click **Access Control** to go back to the main **Access Control** screen.

Figure 66 Access Control: Service Access Control

Services	Active	Service Port	Timeout
Telnet	<input checked="" type="checkbox"/>	23	
SSH	<input checked="" type="checkbox"/>	22	
FTP	<input checked="" type="checkbox"/>	21	
HTTP	<input checked="" type="checkbox"/>	80	3 Minutes
HTTPS	<input checked="" type="checkbox"/>	443	
ICMP	<input checked="" type="checkbox"/>		
SNMP	<input checked="" type="checkbox"/>		

The following table describes the fields in this screen.

Table 39 Access Control: Service Access Control

LABEL	DESCRIPTION
Services	Services you may use to access the switch are listed here.
Active	Select this option for the corresponding services that you want to allow to access the switch.
Service Port	For Telnet, SSH, FTP, HTTP or HTTPS services, you may change the default service port by typing the new port number in the Server Port field. If you change the default port number then you will have to let people (who wish to use the service) know the new port number for that service.
Timeout	Type how many minutes a management session (via the web configurator) can be left idle before the session times out. After it times out you have to log in with your password again. Very long idle timeouts may have security risks.
Apply	Click Apply to save your changes back to the switch.
Cancel	Click Cancel to begin configuring this screen afresh.

18.10 Remote Management

From the **Access Control** screen, display the **Remote Management** screen as shown next.

You can specify a group of one or more “trusted computers” from which an administrator may use a service to manage the switch. Click **Access Control** to return to the **Access Control** screen.

Figure 67 Access Control: Remote Management

Entry	Active	Start Address	End Address	Telnet	FTP	HTTP	ICMP	SNMP	SSH	HTTPS
1	<input checked="" type="checkbox"/>	0.0.0.0	0.0.0.0	<input checked="" type="checkbox"/>	<input checked="" type="checkbox"/>	<input checked="" type="checkbox"/>	<input checked="" type="checkbox"/>	<input checked="" type="checkbox"/>	<input checked="" type="checkbox"/>	<input checked="" type="checkbox"/>
2	<input type="checkbox"/>	0.0.0.0	0.0.0.0	<input type="checkbox"/>	<input type="checkbox"/>	<input type="checkbox"/>	<input type="checkbox"/>	<input type="checkbox"/>	<input type="checkbox"/>	<input type="checkbox"/>
3	<input type="checkbox"/>	0.0.0.0	0.0.0.0	<input type="checkbox"/>	<input type="checkbox"/>	<input type="checkbox"/>	<input type="checkbox"/>	<input type="checkbox"/>	<input type="checkbox"/>	<input type="checkbox"/>
4	<input type="checkbox"/>	0.0.0.0	0.0.0.0	<input type="checkbox"/>	<input type="checkbox"/>	<input type="checkbox"/>	<input type="checkbox"/>	<input type="checkbox"/>	<input type="checkbox"/>	<input type="checkbox"/>

Apply Cancel

The following table describes the labels in this screen.

Table 40 Access Control: Remote Management

LABEL	DESCRIPTION
Entry	This is the client set index number. A “client set” is a group of one or more “trusted computers” from which an administrator may use a service to manage the switch.
Active	Select this check box to activate this secured client set. Clear the check box if you wish to temporarily disable the set without deleting it.
Start Address End Address	Configure the IP address range of trusted computers from which you can manage this switch. The switch checks if the client IP address of a computer requesting a service or protocol matches the range set here. The switch immediately disconnects the session if it does not match.
Telnet/FTP/ HTTP/ICMP/ SNMP/SSH/ HTTPS	Select services that may be used for managing the switch from the specified trusted computers.
Apply	Click Apply to save your changes back to the switch.
Cancel	Click Cancel to begin configuring this screen afresh.

CHAPTER 19

Queuing Method

This chapter introduces the queuing methods supported.

19.1 Introduction to Queuing

Queuing is used to help solve performance degradation when there is network congestion. Use the **Queuing Method** screen to configure queuing algorithms for outgoing traffic. See also **Priority Queue Assignment in Switch Setup** and **802.1p Priority in Port Setup** for related information.

Queuing algorithms allow switches to maintain separate queues for packets from each individual source or flow and prevent a source from monopolizing the bandwidth.

19.1.1 Strictly Priority

Strictly Priority (SP) services queues based on priority only. As traffic comes into the switch, traffic on the highest priority queue, Q7 is transmitted first. When that queue empties, traffic on the next highest-priority queue, Q6 is transmitted until Q6 empties, and then traffic is transmitted on Q5 and so on. If higher priority queues never empty, then traffic on lower priority queues never gets sent. SP does not automatically adapt to changing network requirements.

19.1.2 Weighted Fair Scheduling

Weighted Fair Scheduling is used to guarantee each queue's minimum bandwidth based on its bandwidth weight (portion) (the number you configure in the Weight field - see Figure 18 1) when there is traffic congestion. WFS is activated only when a port has more traffic than it can handle. Queues with larger weights get more guaranteed bandwidth than queues with smaller weights. This queuing mechanism is highly efficient in that it divides any available bandwidth across the different traffic queues. By default, the weight for Q0 is 1, for Q1 is 2, for Q2 is 3, and so on. Guaranteed bandwidth is calculated as follows:

$$\frac{\text{Queue Weight}}{\text{Total Queue Weight}} \times \text{Port Speed}$$

For example, using the default setting, Q0 on Port 1 gets a guaranteed bandwidth of:

$$\frac{1}{1+2+3+4+5+6+7+8} \times 100 \text{ Mbps} = 3 \text{ Mbps}$$

19.2 Configuring Queuing

Click **Advanced Application, Queuing Method** in the navigation panel.

Figure 68 Queuing Method

Queuing Method

Method

Strictly Priority
 Weighted Fair Scheduling
 FE Port SPQ Enable None

Port	Weight							
	Q0	Q1	Q2	Q3	Q4	Q5	Q6	Q7
1	1	2	3	4	5	6	7	8
2	1	2	3	4	5	6	7	8
3	1	2	3	4	5	6	7	8
4	1	2	3	4	5	6	7	8
5	1	2	3	4	5	6	7	8
6	1	2	3	4	5	6	7	8
7	1	2	3	4	5	6	7	8
8	1	2	3	4	5	6	7	8
9	1	2	3	4	5	6	7	8
10	1	2	3	4	5	6	7	8
11	1	2	3	4	5	6	7	8
12	1	2	3	4	5	6	7	8
13	1	2	3	4	5	6	7	8
14	1	2	3	4	5	6	7	8
15	1	2	3	4	5	6	7	8
16	1	2	3	4	5	6	7	8
17	1	2	3	4	5	6	7	8
18	1	2	3	4	5	6	7	8
19	1	2	3	4	5	6	7	8
20	1	2	3	4	5	6	7	8
21	1	2	3	4	5	6	7	8
22	1	2	3	4	5	6	7	8
23	1	2	3	4	5	6	7	8
24	1	2	3	4	5	6	7	8
25	1	2	3	4	5	6	7	8
26	1	2	3	4	5	6	7	8
27	1	2	3	4	5	6	7	8
28	1	2	3	4	5	6	7	8
29	1	2	3	4	5	6	7	8
30	1	2	3	4	5	6	7	8
31	1	2	3	4	5	6	7	8
32	1	2	3	4	5	6	7	8
33	1	2	3	4	5	6	7	8
34	1	2	3	4	5	6	7	8
35	1	2	3	4	5	6	7	8
36	1	2	3	4	5	6	7	8
37	1	2	3	4	5	6	7	8
38	1	2	3	4	5	6	7	8
39	1	2	3	4	5	6	7	8
40	1	2	3	4	5	6	7	8
41	1	2	3	4	5	6	7	8
42	1	2	3	4	5	6	7	8
43	1	2	3	4	5	6	7	8
44	1	2	3	4	5	6	7	8
45	1	2	3	4	5	6	7	8
46	1	2	3	4	5	6	7	8
47	1	2	3	4	5	6	7	8
48	1	2	3	4	5	6	7	8
49	1	2	3	4	5	6	7	8
50	1	2	3	4	5	6	7	8
51	1	2	3	4	5	6	7	8
52	1	2	3	4	5	6	7	8

Apply
Cancel

The following table describes the labels in this screen.

Table 41 Queuing Method

LABEL	DESCRIPTION
Method	<p>Select Strictly Priority or Weighted Fair Scheduling.</p> <p>Strictly Priority services queues based on priority only. When the highest priority queue empties, traffic on the next highest-priority queue begins. Q7 has the highest priority and Q0 the lowest.</p> <p>Weighted Fair Scheduling is used to guarantee each queue's minimum bandwidth based on their bandwidth portion (weight) (the number you configure in the Weight field). Queues with larger weights get more guaranteed bandwidth than queues with smaller weights.</p>
FE Port SPQ Enable	<p>This field is applicable only when you select Weighted Fair Scheduling.</p> <p>Select a queue (Q0 to Q7) to have the switch use Strictly Priority to service the subsequent queue(s) after and including the specified queue for the 10/100 Mbps Ethernet ports. For example, if you select Q5, the switch services traffic on Q5, Q6 and Q7 using Strictly Priority.</p> <p>Select None to always use Weighted Fair Scheduling for the 10/100 Mbps Ethernet ports.</p>
Port	This label shows the port you are configuring.
Weight	<p>When you select Weighted Fair Scheduling, enter the queue weight here. Bandwidth is divided across the different traffic queues according to their weights.</p> <p>For Gigabit ports, if you enter 0 for the queue weight, the switch uses Strictly Priority to service the queue.</p>
Apply	Click Apply to save your changes back to the switch.
Cancel	Click Cancel to begin configuring this screen afresh.

CHAPTER 20

Classifier

This chapter introduces and shows you how to configure the packet classifier on the switch.

20.1 About the Classifier and QoS

Quality of Service (QoS) refers to both a network's ability to deliver data with minimum delay, and the networking methods used to control the use of bandwidth. Without QoS, all traffic data is equally likely to be dropped when the network is congested. This can cause a reduction in network performance and make the network inadequate for time-critical application such as video-on-demand.

A classifier groups traffic into data flows according to specific criteria such as the source address, destination address, source port number, destination port number or incoming port number. For example, you can configure a classifier to select traffic from the same protocol port (such as Telnet) to form a flow.

Configure QoS on the switch to group and prioritize application traffic and fine-tune network performance. Setting up QoS involves two separate steps:

- 1 Configure classifiers to sort traffic into different flows.
- 2 Configure policy rules to define actions to be performed for a classified traffic flow (refer to [Chapter 21 on page 149](#) to configure policy rules).

20.2 Configuring the Classifier

Use the **Classifier** screen to define the classifiers. After you define the classifier, you can specify actions (or policy) to act upon the traffic that match the rules. To configure policy rules, refer to [Chapter 21 on page 149](#).

Click **Advanced Application** and **Classifier** in the navigation panel to display the configuration screen as shown.

Figure 69 Classifier

The following table describes the labels in this screen.

Table 42 Classifier

LABEL	DESCRIPTION
Active	Select this option to enable this rule.
Name	Enter a descriptive name for this rule for identifying purposes.
Packet Format	Specify the format of the packet. Choices are All , 802.3 tagged , 802.3 untagged , Ethernet II tagged and Ethernet II untagged . A value of 802.3 indicates that the packets are formatted according to the IEEE 802.3 standards. A value of Ethernet II indicates that the packets are formatted according to RFC 894, Ethernet II encapsulation.
Layer 2	Specify the fields below to configure a layer 2 classifier.

Table 42 Classifier (continued)

LABEL	DESCRIPTION
VLAN	Select Any to classify traffic from any VLAN or select the second option and specify the source VLAN ID in the field provided.
Priority	Select Any to classify traffic from any priority level or select the second option and specify a priority level in the field provided.
Ethernet Type	Select an Ethernet type or select Other and enter the Ethernet type number in hexadecimal value. Refer to Table 44 on page 146 for information.
Source	
MAC Address	Select Any to apply the rule to all MAC addresses. To specify a source, select the second choice and type a MAC address in valid MAC address format (six hexadecimal character pairs).
Port	Select the port to which the rule should be applied. You may choose one port only or all ports (All Ports).
Destination	
MAC Address	Select Any to apply the rule to all MAC addresses. To specify a destination, select the second choice and type a MAC address in valid MAC address format (six hexadecimal character pairs).
Layer 3 Specify the fields below to configure a layer 3 classifier.	
DSCP	Select Any to classify traffic from any DSCP or select the second option and specify a DSCP (DiffServ Code Point) number between 0 and 63 in the field provided.
IP Protocol	Select an IP protocol type or select Other and enter the protocol number in decimal value. Refer to Table 45 on page 147 for more information. You may select Establish Only for TCP protocol type. This means that the switch will pick out the packets that are sent to establish TCP connections.
Source	
IP Address/Address Prefix	Enter a source IP address in dotted decimal notation. Specify the address prefix by entering the number of ones in the subnet mask.
Socket Number	Note: You must select either UDP or TCP in the IP Protocol field before you configure the socket numbers. Select Any to apply the rule to all TCP/UDP protocol port numbers or select the second option and enter a TCP/UDP protocol port number.
Destination	
IP Address/Address Prefix	Enter a destination IP address in dotted decimal notation. Specify the address prefix by entering the number of ones in the subnet mask.
Socket Number	Note: You must select either UDP or TCP in the IP Protocol field before you configure the socket numbers. Select Any to apply the rule to all TCP/UDP protocol port numbers or select the second option and enter a TCP/UDP protocol port number.
Add	Click Add to insert the entry in the summary table below.

Table 42 Classifier (continued)

LABEL	DESCRIPTION
Cancel	Click Cancel to reset the fields back to your previous configuration.
Clear	Click Clear to set the above fields back to the factory defaults.

20.3 Viewing and Editing Classifier Configuration

To view a summary of the classifier configuration, scroll down to the summary table at the bottom of the **Classifier** screen. To change the settings of a rule, click a number in the **Index** field.

Note: When two rules conflict with each other, a higher layer rule has priority over lower layer rule.

Figure 70 Classifier: Summary Table

Index	Active	Name	Rule	Delete
1	Yes	Example	EtherType = IP; SrcMac = 00:50:ba:ad:4f:81; SrcPort = port 2;	<input type="checkbox"/>

Delete Cancel

The following table describes the labels in this screen.

Table 43 Classifier: Summary Table

LABEL	DESCRIPTION
Index	This field displays the index number of the rule. Click an index number to edit the rule.
Active	This field displays Yes when the rule is activated and No when it is deactivated.
Name	This field displays the descriptive name for this rule. This is for identification purpose only.
Rule	This field displays a summary of the classifier rule's settings.
Delete	Click Delete to remove the selected entry from the summary table.
Cancel	Click Cancel to clear the Delete check boxes.

The following table shows some other common Ethernet types and the corresponding protocol number.

Table 44 Common Ethernet Types and Protocol Number

ETHERNET TYPE	PROTOCOL NUMBER
IP ETHII	0800
X.75 Internet	0801
NBS Internet	0802
ECMA Internet	0803

Table 44 Common Ethernet Types and Protocol Number

ETHERNET TYPE	PROTOCOL NUMBER
Chaosnet	0804
X.25 Level 3	0805
XNS Compat	0807
Banyan Systems	0BAD
BBN Simnet	5208
IBM SNA	80D5
AppleTalk AARP	80F3

Some of the most common IP ports are:

Table 45 Common IP Ports

PORT NUMBER	PORT NAME
21	FTP
23	Telnet
25	SMTP
53	DNS
80	HTTP
110	POP3

20.4 Classifier Example

The following figure shows an example where you configure a classifier that identifies all traffic from MAC address 00:50:ba:ad:4f:81 on port 2.

Figure 71 Classifier: Example

Classifier			
Active	<input checked="" type="checkbox"/>		
Name	Example		
Packet Format	All		
Layer 2	VLAN	<input checked="" type="radio"/> Any <input type="radio"/> <input type="text"/>	
	Priority	<input checked="" type="radio"/> Any <input type="radio"/> 0	
	Ethernet Type	<input checked="" type="radio"/> IP <input type="radio"/> Others <input type="text"/> (Hex)	
	Source	MAC Address	<input type="radio"/> Any <input checked="" type="radio"/> MAC 00 : 50 : ba : ad : 4f : 81
		Port	Port 2
	Destination	MAC Address	<input checked="" type="radio"/> Any <input type="radio"/> MAC <input type="text"/> : <input type="text"/> : <input type="text"/> : <input type="text"/> : <input type="text"/> : <input type="text"/>
Layer 3	DSCP	<input checked="" type="radio"/> Any <input type="radio"/> <input type="text"/>	
	IP Protocol		<input checked="" type="radio"/> All <input type="checkbox"/> Establish Only <input type="radio"/> Others <input type="text"/> (Dec)
		Source	IP Address / Address Prefix
	Destination	Socket Number	<input checked="" type="radio"/> Any <input type="radio"/> <input type="text"/>
		IP Address / Address Prefix	0.0.0.0 / <input type="text"/>
		Socket Number	<input checked="" type="radio"/> Any <input type="radio"/> <input type="text"/>
<input type="button" value="Add"/> <input type="button" value="Cancel"/> <input type="button" value="Clear"/>			

CHAPTER 21

Policy Rule

This chapter shows you how to configure policy rules.

21.1 About Policy Rules

A classifier distinguishes traffic into flows based on the configured criteria (refer to [Chapter 20 on page 143](#) for more information). A policy rule ensures that a traffic flow gets the requested treatment in the network.

21.1.1 DiffServ

DiffServ (Differentiated Services) is a class of service (CoS) model that marks packets so that they receive specific per-hop treatment at DiffServ-compliant network devices along the route based on the application types and traffic flow. Packets are marked with DiffServ Code Points (DSCPs) indicating the level of service desired. This allows the intermediary DiffServ-compliant network devices to handle the packets differently depending on the code points without the need to negotiate paths or remember state information for every flow. In addition, applications do not have to request a particular service or give advanced notice of where the traffic is going.

21.1.2 DSCP and Per-Hop Behavior

DiffServ defines a new DS (Differentiated Services) field to replace the Type of Service (TOS) field in the IP header. The DS field contains a 2-bit unused field and a 6-bit DSCP field which can define up to 64 service levels. The following figure illustrates the DS field.

DSCP is backward compatible with the three precedence bits in the ToS octet so that non-DiffServ compliant, ToS-enabled network device will not conflict with the DSCP mapping.

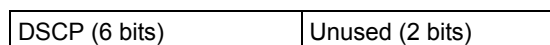

The DSCP value determines the forwarding behavior, the PHB (Per-Hop Behavior), that each packet gets across the DiffServ network. Based on the marking rule, different kinds of traffic can be marked for different kinds of forwarding. Resources can then be allocated according to the DSCP values and the configured policies.

21.2 Configuring Policy Rules

You must first configure a classifier in the Classifier screen. Refer to [Chapter 20 on page 143](#) for more information.

Click **Advanced Applications** and then **Policy Rule** in the navigation panel to display the screen as shown.

Figure 72 Policy

The screenshot shows the 'Policy' configuration interface. At the top, there is a title bar with a 'Policy' label and an orange circle icon. Below this, the form is organized into several sections:

- Active:** A checkbox that is currently unchecked.
- Name:** A text input field.
- Classifier(s):** A larger text input field.
- Parameters:** This section is divided into 'General' and 'Metering' sub-sections.
 - General:** Includes fields for 'VLAN ID' (text input), 'EgressPort' (dropdown menu showing 'Port 1'), 'Outgoing packet format for Egress port' (radio buttons for 'Tag' and 'Untag'), 'Priority' (dropdown menu showing '0'), 'DSCP' (text input), and 'TOS' (dropdown menu showing '0').
 - Metering:** Includes 'Bandwidth' (text input) with 'Kbps' unit, and 'Out-of-Profile DSCP' (text input).
- Action:** This section contains several groups of radio button options:
 - Forwarding:** 'No change' (selected), 'Discard the packet', and 'Do not drop the matching frame previously marked for dropping'.
 - Priority:** 'No change' (selected), 'Set the packet's 802.1 priority', 'Send the packet to priority queue', and 'Replace the 802.1 priority field with the IP TOS value'.
 - Diffserv:** 'No change' (selected), 'Set the packet's TOS field', 'Replace the IP TOS field with the 802.1 priority value', and 'Set the Diffserv Codepoint field in the frame'.
 - Outgoing:** 'Send the packet to the mirror port', 'Send the packet to the egress port', 'Send the matching frames(broadcast or DLF, multicast, marked for dropping or to be sent to the CPU) to the egress port', and 'Set the packet's VLAN ID'.
 - Metering:** 'Enable' checkbox.
 - Out-of-profile action:** 'Drop the packet', 'Change the DSCP value', 'Set Out-Drop Precedence', and 'Do not drop the matching frame previously marked for dropping'.

At the bottom of the form, there are three buttons: 'Add', 'Cancel', and 'Clear'.

The following table describes the labels in this screen.

Table 46 Policy

LABEL	DESCRIPTION
Active	Select this option to enable the policy.
Name	Enter a descriptive name for identification purposes.
Classifier(s)	This field displays the active classifier(s) you configure in the Classifier screen. Select the classifier(s) to which this policy rule applies. To select more than one classifier, press [SHIFT] and select the choices at the same time.
Parameters Set the fields below for this policy. You only have to set the field(s) that is related to the action(s) you configure in the Action field.	
General	
VLAN ID	Specify a VLAN ID number.
Egress Port	Select an outgoing port.
Outgoing packet format for Egress port	Select Tag to add the specified VID to packets on the specified outgoing port. Otherwise, select Untag .
Priority	Specify a priority level.
DSCP	Specify a DSCP (DiffServ Code Point) number between 0 and 63.
TOS	Specify the type of service (TOS) priority level.
Metering	
You can configure the desired bandwidth available to a traffic flow. Traffic that exceeds the maximum bandwidth allocated (in cases where the network is congested) is called out-of-profile traffic.	
Bandwidth	Specify the bandwidth in kilobit per second (Kbps). Enter a number between 1 and 1000000.
Out-of-Profile DSCP	Specify a new DSCP number (between 0 and 63) if you want to replace or remark the DSCP number for out-of-profile traffic.
Action	
Specify the action(s) the switch takes on the associated classified traffic flow.	
Forwarding	
Select No change to forward the packets. Select Discard the packet to drop the packets. Select Do not drop the matching frame previously marked for dropping to retain the frames that were marked to be dropped before.	
Priority	
Select No change to keep the priority setting of the frames. Select Set the packet's 802.1 priority to replace the packet's 802.1 priority field with the value you set in the Priority field. Select Send the packet to priority queue to put the packets in the designated queue. Select Replace the 802.1 priority field with the IP TOS value to replace the packet's 802.1 priority field with the value you set in the TOS field.	

Table 46 Policy (continued)

LABEL	DESCRIPTION
Diffserv	Select No change to keep the TOS and/or DSCP fields in the packets. Select Set the packet's TOS field to set the TOS field with the value you configure in the TOS field. Select Replace the IP TOS with the 802.1 priority value to replace the TOS field with the value you configure in the Priority field. Select Set the Diffserv Codepoint field in the frame to set the DSCP field with the value you configure in the DSCP field.
Outgoing	Select Send the packet to the mirror port to send the packet to the mirror port. Select Send the packet to the egress port to send the packet to the egress port. Select Send the matching frames (broadcast or DLF, multicast, marked for dropping or to be sent to the CPU) to the egress port to send the broadcast, multicast, DLF, marked-to-drop or CPU frames to the egress port. Select Set the packet's VLANID to set the VLAN ID of the packet with the value you configure in the VLANID field.
Metering	Select Enable to activate bandwidth limitation on the traffic flow(s) then set the actions to be taken on out-of-profile packets.
Out-of-profile action	Select the action(s) to be performed for out-of-profile traffic. Select Drop the packet to discard the out-of-profile traffic. Select Change the DSCP value to replace the DSCP field with the value specified in the Out of profile DSCP field. Select Set Out-Drop Precedence to mark out-of-profile traffic and drop it when network is congested. Select Do not drop the matching frame previously marked for dropping to queue the frames that are marked to be dropped.
Add	Click Add to inset the entry to the summary table below.
Cancel	Click Cancel to reset the fields back to your previous configuration.
Clear	Click Clear to set the above fields back to the factory defaults.

21.3 Viewing and Editing Policy Configuration

To view a summary of the classifier configuration, scroll down to the summary table at the bottom of the Policy screen. To change the settings of a rule, click a number in the Index field.

Figure 73 Policy: Summary Table

Index	Active	Name	Classifier(s)	Delete
<u>1</u>	Yes	Test	Example;	<input type="checkbox"/>

The following table describes the labels in this screen.

Table 47 Policy: Summary Table

LABEL	DESCRIPTION
Index	This field displays the policy index number. Click an index number to edit the policy.
Active	This field displays Yes when policy is activated and No when is it deactivated.
Name	This field displays the descriptive name for this policy. This is for identification purposes only.
Classifier(s)	This field displays the name(s) of the classifier to which this policy applies.
Delete	Click Delete to remove the selected entry from the summary table.
Cancel	Click Cancel to clear the Delete check boxes.

21.4 Policy Example

The figure below shows an example **Policy** screen where you configure a policy to limit bandwidth and discard out-of-band traffic on a traffic flow classified using the **Example** classifier (refer to [Section 20.4 on page 147](#)).

Figure 74 Policy Example

Policy																									
Active	<input checked="" type="checkbox"/>																								
Name	Test																								
Classifier(s)	Example																								
Parameters	<table border="0"> <tr> <td>VLAN ID</td> <td><input type="text"/></td> <td>General</td> <td></td> </tr> <tr> <td>EgressPort</td> <td>Port 1</td> <td>Metering</td> <td>Bandwidth <input type="text" value="600"/> Kbps</td> </tr> <tr> <td>Outgoing packet format for Egress port</td> <td><input checked="" type="radio"/> Tag <input type="radio"/> Untag</td> <td></td> <td>Out-of-Profile DSCP <input type="text"/></td> </tr> <tr> <td>Priority</td> <td>0</td> <td></td> <td></td> </tr> <tr> <td>DSCP</td> <td><input type="text"/></td> <td></td> <td></td> </tr> <tr> <td>TOS</td> <td>0</td> <td></td> <td></td> </tr> </table>	VLAN ID	<input type="text"/>	General		EgressPort	Port 1	Metering	Bandwidth <input type="text" value="600"/> Kbps	Outgoing packet format for Egress port	<input checked="" type="radio"/> Tag <input type="radio"/> Untag		Out-of-Profile DSCP <input type="text"/>	Priority	0			DSCP	<input type="text"/>			TOS	0		
	VLAN ID	<input type="text"/>	General																						
	EgressPort	Port 1	Metering	Bandwidth <input type="text" value="600"/> Kbps																					
	Outgoing packet format for Egress port	<input checked="" type="radio"/> Tag <input type="radio"/> Untag		Out-of-Profile DSCP <input type="text"/>																					
	Priority	0																							
	DSCP	<input type="text"/>																							
TOS	0																								
Action	Forwarding <input checked="" type="radio"/> No change <input type="radio"/> Discard the packet <input type="radio"/> Do not drop the matching frame previously marked for dropping																								
	Priority <input checked="" type="radio"/> No change <input type="radio"/> Set the packet's 802.1 priority <input type="radio"/> Send the packet to priority queue <input type="radio"/> Replace the 802.1 priority field with the IP TOS value																								
	Diffserv <input checked="" type="radio"/> No change <input type="radio"/> Set the packet's TOS field <input type="radio"/> Replace the IP TOS field with the 802.1 priority value <input type="radio"/> Set the Diffserv Codepoint field in the frame																								
	Outgoing <input type="checkbox"/> Send the packet to the mirror port <input type="checkbox"/> Send the packet to the egress port <input type="checkbox"/> Send the matching frames(broadcast or DLF, multicast, marked for dropping or to be sent to the CPU) to the egress port <input type="checkbox"/> Set the packet's VLAN ID																								
	Metering <input checked="" type="checkbox"/> Enable																								
	<table border="0"> <tr> <td rowspan="4">Out-of-profile action</td> <td><input checked="" type="checkbox"/> Drop the packet</td> </tr> <tr> <td><input type="checkbox"/> Change the DSCP value</td> </tr> <tr> <td><input type="checkbox"/> Set Out-Drop Precedence</td> </tr> <tr> <td><input type="checkbox"/> Do not drop the matching frame previously marked for dropping</td> </tr> </table>	Out-of-profile action	<input checked="" type="checkbox"/> Drop the packet	<input type="checkbox"/> Change the DSCP value	<input type="checkbox"/> Set Out-Drop Precedence	<input type="checkbox"/> Do not drop the matching frame previously marked for dropping																			
	Out-of-profile action		<input checked="" type="checkbox"/> Drop the packet																						
			<input type="checkbox"/> Change the DSCP value																						
			<input type="checkbox"/> Set Out-Drop Precedence																						
		<input type="checkbox"/> Do not drop the matching frame previously marked for dropping																							
<input type="button" value="Add"/> <input type="button" value="Cancel"/> <input type="button" value="Clear"/>																									

CHAPTER 22

VLAN Stacking

This chapter shows you how to configure VLAN stacking on your switch. See the chapter on VLANs for more background information on Virtual LAN

22.1 Introduction

A service provider can use VLAN stacking to allow it to distinguish multiple customers VLANs, even those with the same (customer-assigned) VLAN ID, within its network.

Use VLAN stacking to add an outer VLAN tag to the inner IEEE 802.1Q tagged frames that enter the network. By tagging the tagged frames (“double-tagged” frames), the service provider can manage up to 4,094 VLAN groups with each group containing up to 4,094 customer VLANs. This allows a service provider to provide different service, based on specific VLANs, for many different customers.

A service provider’s customers may require a range of VLANs to handle multiple applications. A service provider’s customers can assign their own inner VLAN tags on ports for these applications. The service provider can assign an outer VLAN tag for each customer. Therefore, there is no VLAN tag overlap among customers, so traffic from different customers is kept separate.

22.1.1 VLAN Stacking Example

In the following example figure, both A and B are Service Provider’s Network (SPN) customers with VPN tunnels between their head offices and branch offices respectively. Both have an identical VLAN tag for their VLAN group. The service provider can separate these two VLANs within its network by adding tag 37 to distinguish customer A and tag 48 to distinguish customer B at edge device 1 and then stripping those tags at edge device 2 as the data frames leave the network.

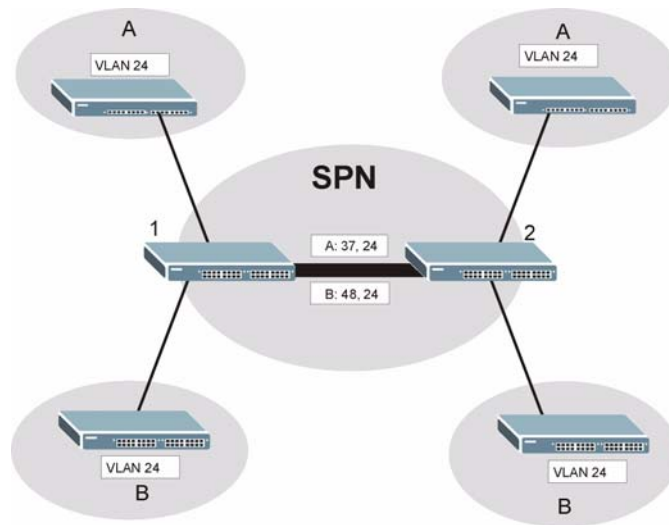
Figure 75 VLAN Stacking Example

22.2 VLAN Stacking Port Roles

Each port can have three VLAN stacking “roles”, **Normal**, **Access Port** and **Tunnel** (the latter is for Gigabit ports only).

- Select **Normal** for “regular” (non-VLAN stacking) IEEE 802.1Q frame switching.
- Select **Access Port** for ingress ports on the service provider's edge devices (1 and 2 in the VLAN stacking example figure). The incoming frame is treated as "untagged", so a second VLAN tag (outer VLAN tag) can be added.

Note: Static VLAN Tx Tagging MUST be disabled on a port where you choose Normal or Access Port.

- Select **Tunnel** (available for Gigabit ports only) for egress ports at the edge of the service provider's network. All VLANs belonging to a customer can be aggregated into a single service provider's VLAN (using the outer VLAN tag defined by SP VID).

Note: Static VLAN Tx Tagging MUST be enabled on a port where you choose Tunnel.

22.3 VLAN Tag Format

A VLAN tag (service provider VLAN stacking or customer IEEE 802.1Q) consists of the following three fields.

Table 48 VLAN Tag Format

Type	Priority	VID
------	----------	-----

Type is a standard Ethernet type code identifying the frame and indicates that whether the frame carries IEEE 802.1Q tag information. **SP TPID** (Service Provider Tag Protocol Identifier) is the service provider VLAN stacking tag type. Many vendors use 0x8100 or 0x9100.

TPID (Tag Protocol Identifier) is the customer IEEE 802.1Q tag.

- If the VLAN stacking port role is **Access Port**, then the switch adds the **SP TPID** tag to all incoming frames on the service provider's edge devices (1 and 2 in the VLAN stacking example figure).
- If the VLAN stacking port role is **Tunnel**, then the switch only adds the **SP TPID** tag to all incoming frames on the service provider's edge devices (1 and 2 in the VLAN stacking example figure) that have an **SP TPID** different to the one configured on the switch. (If an incoming frame's **SP TPID** is the same as the one configured on the switch, then the switch will not add the tag.)

Priority refers to the IEEE 802.1p standard that allows the service provider to prioritize traffic based on the class of service (CoS) the customer has paid for.

- On the switch, configure priority level of inner IEEE 802.1Q tag in the **Port Setup** screen.
- "0" is the lowest priority level and "7" is the highest.

VID is the VLAN ID. **SP VID** is the VID for the second (service provider's) VLAN tag.

22.3.1 Frame Format

The frame format for an untagged Ethernet frame, a single-tagged 802.1Q frame (customer) and a "double-tagged" 802.1Q frame (service provider) is shown next.

Configure the fields as circled in the switch **VLAN Stacking** screen.

Table 49 Single and Double Tagged 802.11Q Frame Format

						DA	SA	Len/Etype	Data	FCS	Untagged Ethernet frame
			DA	SA	TPID	Priority	VID	Len/Etype	Data	FCS	IEEE 802.1Q customer tagged frame
DA	SA	SPTPID	Priority	VID	TPID	Priority	VID	Len/Etype	Data	FCS	Double-tagged frame

Table 50 802.1Q Frame

DA	Destination Address	Priority	802.1p Priority
SA	Source Address	Len/Etype	Length and type of Ethernet frame
(SP)TPID	(Service Provider) Tag Protocol Identifier	Data	Frame data
VID	VLAN ID	FCS	Frame Check Sequence

22.4 Configuring VLAN Stacking

Click **Advanced Applications** and then **VLAN Stacking** in the navigation panel to display the screen as shown.

Figure 76 VLAN Stacking

VLAN Stacking

Active

SP TPID 0x8100 Others (Hex)

Port	Role	SPVID	Priority
1	Access Port	1	0
2	Access Port	1	0
3	Access Port	1	0
4	Access Port	1	0
5	Access Port	1	0
6	Access Port	1	0
7	Access Port	1	0
8	Access Port	1	0
9	Access Port	1	0
10	Access Port	1	0
11	Access Port	1	0
12	Access Port	1	0
13	Access Port	1	0
14	Access Port	1	0
15	Access Port	1	0
16	Access Port	1	0
17	Access Port	1	0
~ ~ ~ ~ ~			
41	Access Port	1	0
42	Access Port	1	0
43	Access Port	1	0
44	Access Port	1	0
45	Access Port	1	0
46	Access Port	1	0
47	Access Port	1	0
48	Access Port	1	0
49	Access Port	1	0
50	Access Port	1	0
51	Access Port	1	0
52	Access Port	1	0

The following table describes the labels in this screen.

Table 51 VLAN Stacking

LABEL	DESCRIPTION
Active	Select this checkbox to enable VLAN stacking on the switch.
SP TPID	SP TPID is a standard Ethernet type code identifying the frame and indicates whether the frame carries IEEE 802.1Q tag information. Choose 0x8100 or 0x9100 from the drop-down list box or select Others and then enter a four-digit hexadecimal number from 0x0000 to 0xFFFF. 0x denotes a hexadecimal number. It does not have to be typed in the Others text field.
Port	The port number identifies the port you are configuring.
Role	<p>Select Normal to have the switch ignore frames received (or transmitted) on this port with VLAN stacking tags. Anything you configure in SPVID and Priority are ignored.</p> <p>Select Access Port to have the switch add the SP TPID tag to all incoming frames received on this port. Select Access Port for ingress ports at the edge of the service provider's network.</p> <p>Select Tunnel (available for Gigabit ports only) for egress ports at the edge of the service provider's network.</p> <p>In order to support VLAN stacking on a port, the port must be able to allow frames of 1526 Bytes (1522 Bytes + 4 Bytes for the second tag) to pass through it.</p>
SPVID	SPVID is the service provider's VLAN ID (the outer VLAN tag). Enter the service provider ID (from 1 to 4094) for frames received on this port. See Chapter 8 on page 77 for more background information on VLAN ID.
Priority	On the switch, configure priority level of inner IEEE 802.1Q tag in the Port Setup screen. "0" is the lowest priority level and "7" is the highest.
Apply	Click Apply to save your changes back to the switch.
Cancel	Click Cancel to begin configuring this screen afresh.

CHAPTER 23

Multicast

This chapter shows you how to configure various multicast features.

23.1 Overview

Traditionally, IP packets are transmitted in one of either two ways - Unicast (1 sender to 1 recipient) or Broadcast (1 sender to everybody on the network). Multicast delivers IP packets to just a group of hosts on the network.

IGMP (Internet Group Multicast Protocol) is a network-layer protocol used to establish membership in a multicast group - it is not used to carry user data. Refer to RFC 1112 and RFC 2236 for information on IGMP versions 1 and 2 respectively.

23.1.1 IP Multicast Addresses

In IPv4, a multicast address allows a device to send packets to a specific group of hosts (multicast group) in a different subnetwork. A multicast IP address represents a traffic receiving group, not individual receiving devices. IP addresses in the Class D range (224.0.0.0 to 239.255.255.255) are used for IP multicasting. Certain IP multicast numbers are reserved by IANA for special purposes (see the IANA web site for more information).

23.1.2 IGMP Filtering

With the IGMP filtering feature, you can control which IGMP groups a subscriber on a port can join. This allows you to control the distribution of multicast services (such as content information distribution) based on service plans and types of subscription.

You can set the switch to filter the multicast group join reports on a per-port basis by configuring an IGMP filtering profile and associating the profile to a port.

23.1.3 IGMP Snooping

A switch can passively snoop on IGMP Query, Report and Leave (IGMP version 2) packets transferred between IP multicast routers/switches and IP multicast hosts to learn the IP multicast group membership. It checks IGMP packets passing through it, picks out the group registration information, and configures multicasting accordingly. IGMP snooping allows the switch to learn multicast groups without you having to manually configure them.

The switch forwards multicast traffic destined for multicast groups (that it has learned from IGMP snooping or that you have manually configured) to ports that are members of that group. IGMP snooping generates no additional network traffic, allowing you to significantly reduce multicast traffic passing through your switch.

23.2 Multicast Status

Click **Advanced Applications** and **Multicast** to display the screen as shown. This screen shows the multicast group information.

Multicast Status			Multicast Setting
Index	VID	Port	Multicast Group
1	1	22	224.0.1.22

The following table describes the labels in this screen.

Table 52 Multicast Status

LABEL	DESCRIPTION
Index	This is the index number of the entry.
VID	This field displays the multicast VLAN ID.
Port	This field displays the port number that belongs to the multicast group.
Multicast Group	This field displays IP multicast group addresses.

23.3 Multicast Setup

Click **Advanced Applications**, **Multicast** and the **Multicast Setting** link to display the screen as shown.

Figure 77 Multicast Setting

Multicast Setting
Multicast Status
IGMP Filtering Profile
MVR

IGMP Snooping Active

IGMP Filtering Active

Unknown Multicast Frame Flooding Drop

Port	Immed. Leave	Group Limited	Max Group Num.	IGMP Filtering Profile
1	<input type="checkbox"/>	<input type="checkbox"/>	0	Default
2	<input type="checkbox"/>	<input type="checkbox"/>	0	Default
3	<input type="checkbox"/>	<input type="checkbox"/>	0	Default
4	<input type="checkbox"/>	<input type="checkbox"/>	0	Default
5	<input type="checkbox"/>	<input type="checkbox"/>	0	Default
6	<input type="checkbox"/>	<input type="checkbox"/>	0	Default
7	<input type="checkbox"/>	<input type="checkbox"/>	0	Default
8	<input type="checkbox"/>	<input type="checkbox"/>	0	Default
9	<input type="checkbox"/>	<input type="checkbox"/>	0	Default
10	<input type="checkbox"/>	<input type="checkbox"/>	0	Default
11	<input type="checkbox"/>	<input type="checkbox"/>	0	Default
12	<input type="checkbox"/>	<input type="checkbox"/>	0	Default
13	<input type="checkbox"/>	<input type="checkbox"/>	0	Default
14	<input type="checkbox"/>	<input type="checkbox"/>	0	Default
15	<input type="checkbox"/>	<input type="checkbox"/>	0	Default
16	<input type="checkbox"/>	<input type="checkbox"/>	0	Default
17	<input type="checkbox"/>	<input type="checkbox"/>	0	Default
18	<input type="checkbox"/>	<input type="checkbox"/>	0	Default
19	<input type="checkbox"/>	<input type="checkbox"/>	0	Default
42	<input type="checkbox"/>	<input type="checkbox"/>	0	Default
43	<input type="checkbox"/>	<input type="checkbox"/>	0	Default
44	<input type="checkbox"/>	<input type="checkbox"/>	0	Default
45	<input type="checkbox"/>	<input type="checkbox"/>	0	Default
46	<input type="checkbox"/>	<input type="checkbox"/>	0	Default
47	<input type="checkbox"/>	<input type="checkbox"/>	0	Default
48	<input type="checkbox"/>	<input type="checkbox"/>	0	Default
49	<input type="checkbox"/>	<input type="checkbox"/>	0	Default
50	<input type="checkbox"/>	<input type="checkbox"/>	0	Default
51	<input type="checkbox"/>	<input type="checkbox"/>	0	Default
52	<input type="checkbox"/>	<input type="checkbox"/>	0	Default

The following table describes the labels in this screen.

Table 53 Multicast Setting

LABEL	DESCRIPTION
IGMP Snooping	Select Active to enable IGMP snooping to forward group multicast traffic only to ports that are members of that group.
IGMP Filtering	Select Active to enable IGMP filtering to control which IGMP groups a subscriber on a port can join.
Unknown Multicast Frame	Specify the action to perform when the switch receives an unknown multicast frame. Select Drop to discard the frame(s). Select Flooding to send the frame(s) to all ports.
Port	This field displays the port number.
Immed. Leave	Select this option to set the switch to remove this port from the multicast tree when an IGMP version 2 leave message is received on this port. Select this option if there is only one host connected to this port.
Group Limited	Select this option to limit the number of multicast groups this port is allowed to join.
Max Group Num.	Enter the number of multicast groups this port is allowed to join. Once a port is registered in the specified number of multicast groups, any new IGMP join report frame(s) is dropped on this port.
IGMP Filtering Profile	Select the name of the IGMP filtering profile to use for this port. Otherwise, select Default to prohibit the port from joining any multicast group.
Apply	Click Apply to save your changes back to the switch.
Cancel	Click Cancel to begin configuring this screen afresh.

23.4 IGMP Filtering Profile

IGMP filter profiles allow you to control access to IGMP multicast groups. This allows you to have a service available to a specific IGMP multicast group. You can configure an IGMP filter profile for an IGMP multicast group that has access to a service (like a SIP server for example). Within a profile, configure an IGMP filter to specify the multicast IP address ranges. Then assign the IGMP filter profile to the ports (in the **Multicast Setting** screen) that are allowed to use the service.

Click **Advanced Applications** and **Multicast** in the navigation panel. Click the **Multicast Setting** link and then the **IGMP Filtering Profile** link to display the screen as shown.

Figure 78 Multicast: IGMP Filtering Profile

The screenshot shows a web interface for configuring an IGMP Filtering Profile. At the top, there's a title bar with 'IGMP Filtering Profile' and 'Multicast Setting'. Below that, the 'Profile Setup' section contains three input fields: 'Profile Name', 'Start Address' (pre-filled with 224.0.0.0), and 'End Address' (pre-filled with 224.0.0.0). Underneath these fields are two buttons: 'Add' and 'Clear'. Below the buttons is a table with the following structure:

Profile Name	Start Address	End Address	Delete Profile	Delete Rule
Default	0.0.0.0	0.0.0.0	<input type="checkbox"/>	<input type="checkbox"/>

At the bottom of the screen, there are two buttons: 'Delete' and 'Cancel'.

The following table describes the labels in this screen.

Table 54 Multicast: IGMP Filtering Profile

LABEL	DESCRIPTION
Profile Name	Enter a descriptive name for the profile for identification purposes. To configure additional rule(s) for a profile that you have already added, enter the profile name and specify a different IP multicast address range.
Start Address	Type the starting multicast IP address for a range of multicast IP addresses that you want to belong to the IGMP filter profile.
End Address	Type the ending multicast IP address for a range of IP addresses that you want to belong to the IGMP filter profile. If you want to add a single multicast IP address, enter it in both the Start Address and End Address fields.
Add	Click Add to save the settings to the switch.
Clear	Click Clear to clear the fields to the factory defaults.
Profile Name	This field displays the descriptive name of the profile.
Start Address	This field displays the start of the multicast address range.
End Address	This field displays the end of the multicast address range.
Delete	To delete the profile(s) and all the accompanying rules, select the profile(s) that you want to remove in the Delete Profile column, then click the Delete button. To delete a rule(s) from a profile, select the rule(s) that you want to remove in the Delete Rule column, then click the Delete button.
Cancel	Click Cancel to clear the Delete Profile/Delete Rule check boxes.

23.5 MVR Overview

Multicast VLAN Registration (MVR) is designed for applications (such as Media-on-Demand (MoD)) that use multicast traffic across an Ethernet ring-based service provider network.

MVR allows one single multicast VLAN to be shared among different subscriber VLANs on the network. While isolated in different subscriber VLANs, connected devices can subscribe to and unsubscribe from the multicast stream in the multicast VLAN. This improves bandwidth utilization with reduced multicast traffic in the subscriber VLANs and simplifies multicast group management.

You must enable IGMP snooping to use MVR. However, MVR only responds to IGMP join and leave control messages from multicast groups that are configured under MVR. Join and leave reports from other multicast groups are managed by IGMP snooping.

The following figure shows a network example. The subscriber VLAN (**1, 2 and 3**) information is hidden from the streaming media server, **S**. In addition, the multicast VLAN information is only visible to the switch and **S**.

Figure 79 MVR Network Example

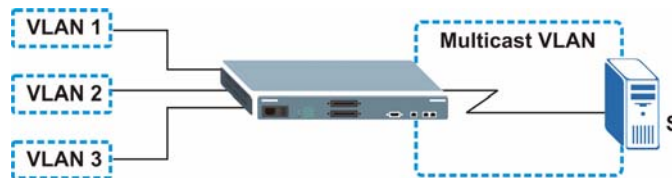

23.5.1 Types of MVR Ports

In MVR, a source port is a port on the switch that can send and receive multicast traffic in a multicast VLAN while a receiver port can only receive multicast data. Once configured, the switch maintains a forwarding table that matches the multicast stream to the associated multicast group.

23.5.2 MVR Modes

You can set your switch to operate in either dynamic or compatible mode.

In dynamic mode, the switch sends IGMP leave and join reports to the other multicast devices (such as multicast routers or servers) in the multicast VLAN. This allows the multicast devices to update the multicast forwarding table to forward or not forward multicast traffic to the receiver ports.

In compatible mode, the switch does not send any IGMP reports. In this case, you must manually configure the forwarding settings on the multicast devices in the multicast VLAN.

23.5.3 How MVR Works

The following figure shows a multicast television example where a subscriber device (such as a computer) in VLAN 1 receives multicast traffic from the streaming media server, **S**, via the switch. Multiple subscriber devices can connect through a port configured as the receiver on the switch.

When the subscriber selects a television channel, computer **A** sends an IGMP report to the switch to join the appropriate multicast group. If the IGMP report matches one of the configured MVR multicast group addresses on the switch, an entry is created in the forwarding table on the switch. This maps the subscriber VLAN to the list of forwarding destinations for the specified multicast traffic.

When the subscriber changes the channel or turns off the computer, an IGMP leave message is sent to the switch to leave the multicast group. The switch sends a query to VLAN 1 on the receiver port (in this case, a DSL port on the switch). If there is another subscriber device connected to this port in the same subscriber VLAN, the receiving port will still be on the list of forwarding destination for the multicast traffic. Otherwise, the switch removes the receiver port from the forwarding table.

Figure 80 MVR Multicast Television Example

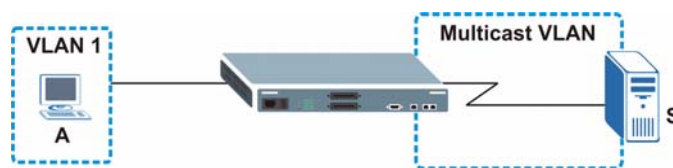

23.6 General MVR Configuration

Use the **MVR** screen to create multicast VLANs and select the receiver port(s) and a source port for each multicast VLAN. Click **Advanced Applications** and **Multicast** in the navigation panel. Click the **Multicast Setting** link and then the **MVR** link to display the screen as shown next.

Note: You can create up to three multicast VLANs and up to 256 multicast rules on the switch.

Your switch automatically creates a static VLAN (with the same VID) when you create a multicast VLAN in this screen.

Figure 81 MVR

MVR
Multicast Setting Group Configuration

Active

Name

Multicast VLAN ID

Mode Dynamic Compatible

Port	Source Port	Receiver Port	None	Tagging
1	<input type="radio"/>	<input type="radio"/>	<input checked="" type="radio"/>	<input type="checkbox"/>
2	<input type="radio"/>	<input type="radio"/>	<input checked="" type="radio"/>	<input type="checkbox"/>
3	<input type="radio"/>	<input type="radio"/>	<input checked="" type="radio"/>	<input type="checkbox"/>
4	<input type="radio"/>	<input type="radio"/>	<input checked="" type="radio"/>	<input type="checkbox"/>
5	<input type="radio"/>	<input type="radio"/>	<input checked="" type="radio"/>	<input type="checkbox"/>
6	<input type="radio"/>	<input type="radio"/>	<input checked="" type="radio"/>	<input type="checkbox"/>
7	<input type="radio"/>	<input type="radio"/>	<input checked="" type="radio"/>	<input type="checkbox"/>
8	<input type="radio"/>	<input type="radio"/>	<input checked="" type="radio"/>	<input type="checkbox"/>
9	<input type="radio"/>	<input type="radio"/>	<input checked="" type="radio"/>	<input type="checkbox"/>
10	<input type="radio"/>	<input type="radio"/>	<input checked="" type="radio"/>	<input type="checkbox"/>
11	<input type="radio"/>	<input type="radio"/>	<input checked="" type="radio"/>	<input type="checkbox"/>
12	<input type="radio"/>	<input type="radio"/>	<input checked="" type="radio"/>	<input type="checkbox"/>
13	<input type="radio"/>	<input type="radio"/>	<input checked="" type="radio"/>	<input type="checkbox"/>
14	<input type="radio"/>	<input type="radio"/>	<input checked="" type="radio"/>	<input type="checkbox"/>
15	<input type="radio"/>	<input type="radio"/>	<input checked="" type="radio"/>	<input type="checkbox"/>
16	<input type="radio"/>	<input type="radio"/>	<input checked="" type="radio"/>	<input type="checkbox"/>
17	<input type="radio"/>	<input type="radio"/>	<input checked="" type="radio"/>	<input type="checkbox"/>
18	<input type="radio"/>	<input type="radio"/>	<input checked="" type="radio"/>	<input type="checkbox"/>
...				
42	<input type="radio"/>	<input type="radio"/>	<input checked="" type="radio"/>	<input type="checkbox"/>
43	<input type="radio"/>	<input type="radio"/>	<input checked="" type="radio"/>	<input type="checkbox"/>
44	<input type="radio"/>	<input type="radio"/>	<input checked="" type="radio"/>	<input type="checkbox"/>
45	<input type="radio"/>	<input type="radio"/>	<input checked="" type="radio"/>	<input type="checkbox"/>
46	<input type="radio"/>	<input type="radio"/>	<input checked="" type="radio"/>	<input type="checkbox"/>
47	<input type="radio"/>	<input type="radio"/>	<input checked="" type="radio"/>	<input type="checkbox"/>
48	<input type="radio"/>	<input type="radio"/>	<input checked="" type="radio"/>	<input type="checkbox"/>
49	<input type="radio"/>	<input type="radio"/>	<input checked="" type="radio"/>	<input type="checkbox"/>
50	<input type="radio"/>	<input type="radio"/>	<input checked="" type="radio"/>	<input type="checkbox"/>
51	<input type="radio"/>	<input type="radio"/>	<input checked="" type="radio"/>	<input type="checkbox"/>
52	<input type="radio"/>	<input type="radio"/>	<input checked="" type="radio"/>	<input type="checkbox"/>

VLAN	Active	Name	Mode	Source Port	Receiver Port	Delete

The following table describes the related labels in this screen.

Table 55 MVR

LABEL	DESCRIPTION
Active	Select this check box to enable MVR to allow one single multicast VLAN to be shared among different subscriber VLANs on the network.
Name	Enter a descriptive name (up to 32 printable ASCII characters) for identification purposes.
Multicast VLAN ID	Enter the VLAN ID (1 to 4094) of the multicast VLAN.
Mode	Specify the MVR mode on the switch. Choices are Dynamic and Compatible . Select Dynamic to send IGMP reports to all MVR source ports in the multicast VLAN. Select Compatible to set the switch not to send IGMP reports.
Port	This field displays the port number on the switch.
Source Port	This field is applicable for Ethernet ports. Select this option to set this port as the MVR source port that sends and receives multicast traffic. All source ports must belong to a single multicast VLAN.
Receiver Port	Select this option to set this port as a receiver port that only receives multicast traffic. A receiver port cannot belong to a multicast VLAN.
None	Select this option to set the port not to participate in MVR. No MVR multicast traffic is sent or received on this port.
Tagging	Select this checkbox if you want the port to tag the VLAN ID in all outgoing frames transmitted.
Add	Click Add to save the settings.
Cancel	Click Cancel to discard all changes.
VLAN	This field displays the multicast VLAN ID.
Active	This field displays whether the multicast group is enabled or not.
Name	This field displays the descriptive name for this setting.
Mode	This field displays the MVR mode.
Source Port	This field displays the source port number(s).
Receiver Port	This field displays the receiver port number(s).
Delete	To delete a multicast VLAN(s), select the rule(s) that you want to remove in the Delete column, then click the Delete button.
Cancel	Click Cancel to clear the Delete check boxes.

23.7 MVR Group Configuration

All source ports and receiver ports belonging to a multicast group can receive multicast data sent to this multicast group.

Configure MVR IP multicast group address(es) in the **Group Configuration** screen. Click **Group Configuration** in the **MVR** screen.

Note: A port can belong to more than one multicast VLAN. However, IP multicast group addresses in different multicast VLANs cannot overlap.

Figure 82 MVR: Group Configuration

The following table describes the labels in this screen.

Table 56 MVR: Group Configuration

LABEL	DESCRIPTION
Multicast VLAN ID	Select a multicast VLAN ID (that you configured in the MVR screen) from the drop-down list box.
Name	Enter a descriptive name for identification purposes.
Start Address	Enter the starting IP multicast address of the multicast group in dotted decimal notation. Refer to Section 23.1.1 on page 161 for more information on IP multicast addresses.
End Address	Enter the ending IP multicast address of the multicast group in dotted decimal notation. Enter the same IP address as the Start Address field if you want to configure only one IP address for a multicast group. Refer to Section 23.1.1 on page 161 for more information on IP multicast addresses.
Add	Click Add to save the settings.
Cancel	Click Cancel to discard all changes.
MVLAN	This field displays the multicast VLAN ID.
Name	This field displays the descriptive name for this setting.
Start Address	This field displays the starting IP address of the multicast group.
End Address	This field displays the ending IP address of the multicast group.
Delete	Select Delete All and click Delete to remove all entries from the table. Select Delete Group and click Delete to remove the selected entry(ies) from the table.
Cancel	Select Cancel to clear the checkbox(es) in the table.

23.7.1 MVR Configuration Example

The following figure shows a network example where ports 1, 2 and 3 on the switch belong to VLAN 1. In addition, port 17 belongs to the multicast group with VID 200 to receive multicast traffic (the **News** and **Movie** channels) from the remote streaming media server, **S**. Computers **A**, **B** and **C** in VLAN are able to receive the traffic.

Figure 83 MVR Configuration Example

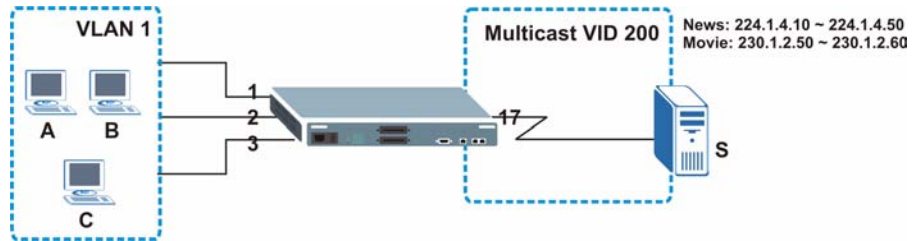

To configure the MVR settings on the switch, create a multicast group in the **MVR** screen and set the receiver and source ports.

Figure 84 MVR Configuration Example

MVR Multicast Setting **Group Configuration**

Active

Name

Multicast VLAN ID

Mode Dynamic Compatible

Port	Source Port	Receiver Port	None	Tagging
1	<input type="radio"/>	<input checked="" type="radio"/>	<input type="radio"/>	<input type="checkbox"/>
2	<input type="radio"/>	<input checked="" type="radio"/>	<input type="radio"/>	<input type="checkbox"/>
3	<input type="radio"/>	<input checked="" type="radio"/>	<input type="radio"/>	<input type="checkbox"/>
4	<input type="radio"/>	<input type="radio"/>	<input checked="" type="radio"/>	<input type="checkbox"/>
5	<input type="radio"/>	<input type="radio"/>	<input checked="" type="radio"/>	<input type="checkbox"/>
6	<input type="radio"/>	<input type="radio"/>	<input checked="" type="radio"/>	<input type="checkbox"/>
7	<input type="radio"/>	<input type="radio"/>	<input checked="" type="radio"/>	<input type="checkbox"/>
8	<input type="radio"/>	<input type="radio"/>	<input checked="" type="radio"/>	<input type="checkbox"/>
9	<input type="radio"/>	<input type="radio"/>	<input checked="" type="radio"/>	<input type="checkbox"/>
10	<input type="radio"/>	<input type="radio"/>	<input checked="" type="radio"/>	<input type="checkbox"/>
11	<input type="radio"/>	<input type="radio"/>	<input checked="" type="radio"/>	<input type="checkbox"/>
12	<input type="radio"/>	<input type="radio"/>	<input checked="" type="radio"/>	<input type="checkbox"/>
13	<input type="radio"/>	<input type="radio"/>	<input checked="" type="radio"/>	<input type="checkbox"/>
14	<input type="radio"/>	<input type="radio"/>	<input checked="" type="radio"/>	<input type="checkbox"/>
15	<input type="radio"/>	<input type="radio"/>	<input checked="" type="radio"/>	<input type="checkbox"/>
16	<input type="radio"/>	<input type="radio"/>	<input checked="" type="radio"/>	<input type="checkbox"/>
17	<input type="radio"/>	<input checked="" type="radio"/>	<input type="radio"/>	<input type="checkbox"/>
18	<input type="radio"/>	<input type="radio"/>	<input checked="" type="radio"/>	<input type="checkbox"/>
42	<input type="radio"/>	<input type="radio"/>	<input checked="" type="radio"/>	<input type="checkbox"/>
43	<input type="radio"/>	<input type="radio"/>	<input checked="" type="radio"/>	<input type="checkbox"/>
44	<input type="radio"/>	<input type="radio"/>	<input checked="" type="radio"/>	<input type="checkbox"/>
45	<input type="radio"/>	<input type="radio"/>	<input checked="" type="radio"/>	<input type="checkbox"/>
46	<input type="radio"/>	<input type="radio"/>	<input checked="" type="radio"/>	<input type="checkbox"/>
47	<input type="radio"/>	<input type="radio"/>	<input checked="" type="radio"/>	<input type="checkbox"/>
48	<input type="radio"/>	<input type="radio"/>	<input checked="" type="radio"/>	<input type="checkbox"/>
49	<input type="radio"/>	<input type="radio"/>	<input checked="" type="radio"/>	<input type="checkbox"/>
50	<input type="radio"/>	<input type="radio"/>	<input checked="" type="radio"/>	<input type="checkbox"/>
51	<input type="radio"/>	<input type="radio"/>	<input checked="" type="radio"/>	<input type="checkbox"/>
52	<input type="radio"/>	<input type="radio"/>	<input checked="" type="radio"/>	<input type="checkbox"/>

Add Cancel

To set the switch to forward the multicast group traffic to the subscribers, configure multicast group settings in the **Group Configuration** screen. The following figure shows an example where two multicast groups (**News** and **Movie**) are configured for the multicast VLAN 200.

Figure 85 MVR Group Configuration Example

Group Configuration MVR

Multicast VLAN ID: 200

Name	Start Address	End Address
News	224.1.4.10	224.1.4.50

Add Cancel

MVLAN	Name	Start Address	End Address	Delete All	Delete Group
200	Movie	230.1.2.50	230.1.2.60	<input type="checkbox"/>	<input type="checkbox"/>

Delete Cancel

Figure 86 MVR Group Configuration Example

Group Configuration MVR

Multicast VLAN ID: 200

Name	Start Address	End Address
	0.0.0.0	0.0.0.0

Add Cancel

MVLAN	Name	Start Address	End Address	Delete All	Delete Group
200	Movie	230.1.2.50	230.1.2.60	<input type="checkbox"/>	<input type="checkbox"/>
	News	224.1.4.10	224.1.4.50	<input type="checkbox"/>	<input type="checkbox"/>

Delete Cancel

CHAPTER 24

DHCP Relay

This chapter shows you how to set up DHCP relay.

24.1 DHCP Relay Overview

DHCP (Dynamic Host Configuration Protocol, RFC 2131 and RFC 2132) allows individual clients to obtain TCP/IP configuration at start-up from a DHCP server. You can configure the switch to relay client DHCP requests to a DHCP server and the server's responses back to the clients.

24.1.1 DHCP Relay Agent Information

The switch can add information to client DHCP requests that it relays to a DHCP server. This helps provide authentication about the source of the requests. You can also specify additional information for the switch to add to the client DHCP requests that it relays to the DHCP server. Please refer to RFC 3046 for more details.

The DHCP relay agent information feature adds an Agent Information field to the option 82 field of the DHCP headers of client TCP/IP configuration request frames that the switch relays to a DHCP server. The following lists the DHCP relay agent option 82 information that the switch sends to the DHCP server:

- Slot ID (1 byte)
- Port ID (1 byte)
- VLAN ID (2 bytes)
- System name (up to 32 bytes, this is optional).

24.2 DHCP Relay Configuration

To configure DHCP relay information and specify the DHCP server(s), click **Advanced Application** and **DHCP Relay** to display the screen as shown next.

Figure 87 DHCP Relay

The screenshot shows the DHCP Relay configuration interface. It includes a title bar, an 'Active' checkbox, three 'Remote DHCP Server' fields (all set to 0.0.0.0), a 'Relay Agent Information' checkbox with 'Option 82' text, an 'Information' checkbox with a text box containing 'ES-3148', and 'Apply' and 'Cancel' buttons at the bottom.

The following table describes the labels in this screen.

Table 57 DHCP Relay

LABEL	DESCRIPTION
Active	Select this check box to enable DHCP relay.
Remote DHCP Server 1 .. 3	Enter the IP address of a DHCP server in dotted decimal notation.
Relay Agent Information	Select the Option 82 check box to have the switch add information (slot number, port number and VLAN ID) to client DHCP requests that it relays to a DHCP server.
Information	This read-only field displays the system name you configure in the General Setup screen. Select the check box for the switch to add the system name to the DHCP client DHCP requests that it relays to a DHCP server.
Apply	Click Apply to save your changes back to the switch.
Cancel	Click Cancel to begin configuring this screen afresh.

CHAPTER 25

Static Route

This chapter shows you how to configure static routes.

25.1 Configuring

Static routes tell the switch how to forward IP traffic when you configure the TCP/IP parameters manually.

Click **IP Application**, **Static Routing** in the navigation panel to display the screen as shown.

Figure 88 Static Routing

The following table describes the related labels you use to create a static route.

Table 58 Static Routing

LABEL	DESCRIPTION
Active	This field allows you to activate/deactivate this static route.
Name	Enter a descriptive name (up to 32 printable ASCII characters) for identification purposes.

Table 58 Static Routing (continued)

LABEL	DESCRIPTION
Destination IP Address	This parameter specifies the IP network address of the final destination. Routing is always based on network number. If you need to specify a route to a single host, use a subnet mask of 255.255.255.255 in the subnet mask field to force the network number to be identical to the host ID.
IP Subnet Mask	Enter the subnet mask for this destination.
Gateway IP Address	Enter the IP address of the gateway. The gateway is an immediate neighbor of your switch that will forward the packet to the destination. The gateway must be a router on the same segment as your switch.
Metric	The metric represents the "cost" of transmission for routing purposes. IP routing uses hop count as the measurement of cost, with a minimum of 1 for directly connected networks. Enter a number that approximates the cost for this link. The number need not be precise, but it must be between 1 and 15. In practice, 2 or 3 is usually a good number.
Add	Click Add to insert a new static route.
Cancel	Click Cancel to reset the above fields to your previous configuration.
Clear	Click Clear to set the above fields back to the factory defaults.
Index	This field displays the index number of the route. Click a number to edit the static route entry.
Active	This field displays Yes when the static route is activated and NO when it is deactivated.
Name	This field displays the descriptive name for this route. This is for identification purpose only.
Destination Address	This field displays the IP network address of the final destination.
Subnet Mask	This field displays the subnet mask for this destination.
Gateway Address	This field displays the IP address of the gateway. The gateway is an immediate neighbor of your switch that will forward the packet to the destination.
Metric	This field displays the cost of transmission for routing purposes.
Delete	Click Delete to remove the selected entry from the summary table.
Cancel	Click Cancel to clear the Delete check boxes.

CHAPTER 26

Maintenance

This chapter explains how to configure the maintenance screens that let you maintain the firmware and configuration files.

26.1 The Maintenance Screen

Click **Management, Maintenance** in the navigation panel to open the following screen.

Figure 89 Maintenance



26.2 Firmware Upgrade

Make sure you have downloaded (and unzipped) the correct model firmware and version to your computer before uploading to the device.

Note: Be sure to upload the correct model firmware as uploading the wrong model firmware may damage your device.

From the **Maintenance** screen, display the **Firmware Upgrade** screen as shown next.

Figure 90 Firmware Upgrade

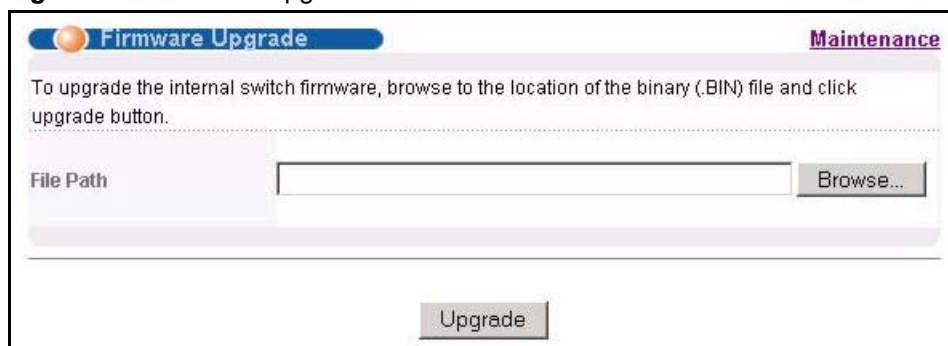

Type the path and file name of the firmware file you wish to upload to the switch in the **File Path** text box or click **Browse** to locate it. After you have specified the file, click **Upgrade**.

After the firmware upgrade process is complete, see the **System Info** screen to verify your current firmware version number.

26.3 Restore a Configuration File

Restore a previously saved configuration from your computer to the switch using the **Restore Configuration** screen.

Figure 91 Restore Configuration

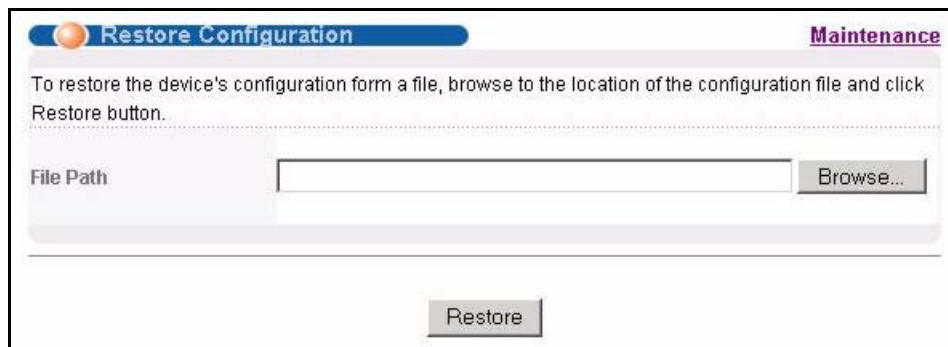

The screenshot shows a web interface for restoring a configuration. At the top, there is a blue header with an orange circle icon, the text 'Restore Configuration', and a 'Maintenance' link. Below the header is a light gray box containing the instruction: 'To restore the device's configuration from a file, browse to the location of the configuration file and click Restore button.' Underneath this instruction is a 'File Path' label followed by a text input field and a 'Browse...' button. At the bottom center of the main content area is a 'Restore' button.

Type the path and file name of the configuration file you wish to restore in the **File Path** text box or click **Browse** to display the **Choose File** screen (below) from which you can locate it. After you have specified the file, click **Restore**. "config" is the name of the configuration file on the switch, so your backup configuration file is automatically renamed when you restore using this screen.

26.4 Backing Up a Configuration File

Backing up your switch configurations allows you to create various “snap shots” of your device from which you may restore at a later date.

Back up your current switch configuration to a computer using the **Backup Configuration** screen.

Figure 92 Backup Configuration

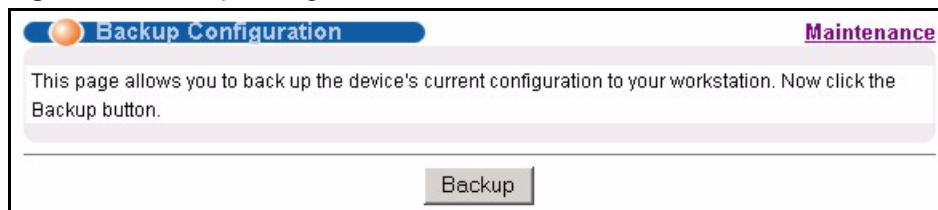

The screenshot shows a web interface for backing up a configuration. At the top, there is a blue header with an orange circle icon, the text 'Backup Configuration', and a 'Maintenance' link. Below the header is a light gray box containing the instruction: 'This page allows you to back up the device's current configuration to your workstation. Now click the Backup button.' At the bottom center of the main content area is a 'Backup' button.

Follow the steps below to back up the current switch configuration to your computer in this screen.

- 1 Click **Backup**.
- 2 Click **Save** to display the **Save As** screen.
- 3 Choose a location to save the file on your computer from the **Save in** drop-down list box and type a descriptive name for it in the **File name** list box. Click **Save** to save the configuration file to your computer.

26.5 Load Factory Defaults

Follow the steps below to reset the switch back to the factory defaults.

- 1 In the **Maintenance** screen, click the **Click Here** button next to **Load Factory Defaults** to clear all switch configuration information you configured and return to the factory defaults. The following message appears.

Figure 93 Load Factory Default: Conformation



- 2 Click **OK** to display the screen shown next.

Figure 94 Load Factory Default: Start

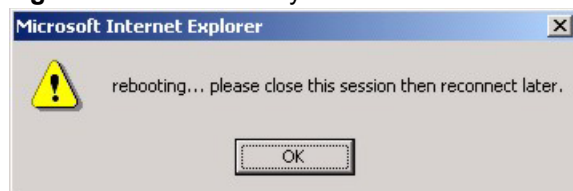

- 3 Click **OK** to begin resetting all switch configurations to the factory defaults and then wait for the switch to restart. This takes up to two minutes. If you want to access the switch web configurator again, you may need to change the IP address of your computer to be in the same subnet as that of the default switch IP address (192.168.1.1).

26.6 Reboot System

Reboot System allows you to restart the switch without physically turning the power off. Follow the steps below to reboot the switch.

- 1 In the **Maintenance** screen, click the **Click Here** button next to **Reboot System** to display the next screen.

Figure 95 Reboot System: Confirmation

2 Click **OK** to display the screen shown next.

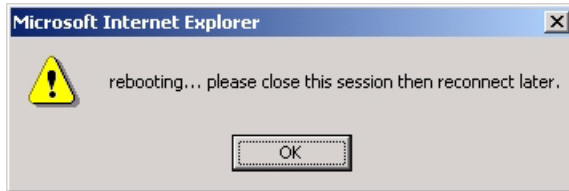
Figure 96 Reboot System: Start

3 Click **OK** again and then wait for the switch to restart. This takes up to two minutes. This does not affect the switch's configuration.

26.7 FTP Command Line

This section shows some examples of uploading to or downloading files from the switch using FTP commands. First, understand the filename conventions.

26.7.1 Filename Conventions

The configuration file (also known as the romfile or ROM) contains the factory default settings in the screens such as password, switch setup, IP Setup, etc.. Once you have customized the switch's settings, they can be saved back to your computer under a filename of your choosing.

ZyNOS (ZyXEL Network Operating System sometimes referred to as the "ras" file) is the system firmware and has a "bin" filename extension.

Table 59 Filename Conventions

FILE TYPE	INTERNAL NAME	EXTERNAL NAME	DESCRIPTION
Configuration File	config		This is the configuration filename on the switch. Uploading the config file replaces the specified configuration file system, including your switch configurations, system-related data (including the default password), the error log and the trace log.
Firmware	Ras	*.bin	This is the generic name for the ZyNOS firmware on the switch.

26.7.1.1 Example FTP Commands

```
ftp> put firmware.bin ras
```

This is a sample FTP session showing the transfer of the computer file "firmware.bin" to the switch.

```
ftp> get config config.cfg
```

This is a sample FTP session saving the current configuration to a file called "config.cfg" on your computer.

If your (T)FTP client does not allow you to have a destination filename different than the source, you will need to rename them as the switch only recognizes "config" and "ras". Be sure you keep unaltered copies of both files for later use.

Note: Be sure to upload the correct model firmware as uploading the wrong model firmware may damage your device.

26.7.2 FTP Command Line Procedure

- 1 Launch the FTP client on your computer.
- 2 Enter `open`, followed by a space and the IP address of your switch.
- 3 Press [ENTER] when prompted for a username.
- 4 Enter your password as requested (the default is "1234").
- 5 Enter `bin` to set transfer mode to binary.
- 6 Use `put` to transfer files from the computer to the switch, for example, `put firmware.bin ras` transfers the firmware on your computer (`firmware.bin`) to the switch and renames it to "ras". Similarly, `put config.cfg config` transfers the configuration file on your computer (`config.cfg`) to the switch and renames it to "config". Likewise `get config config.cfg` transfers the configuration file on the switch to your computer and renames it to "config.cfg". See [Table 59 on page 182](#) for more information on filename conventions.
- 7 Enter `quit` to exit the ftp prompt.

26.7.3 GUI-based FTP Clients

The following table describes some of the commands that you may see in GUI-based FTP clients.

General Commands for GUI-based FTP Clients

COMMAND	DESCRIPTION
Host Address	Enter the address of the host server.
Login Type	Anonymous. This is when a user I.D. and password is automatically supplied to the server for anonymous access. Anonymous logins will work only if your ISP or service administrator has enabled this option. Normal. The server requires a unique User ID and Password to login.
Transfer Type	Transfer files in either ASCII (plain text format) or in binary mode. Configuration and firmware files should be transferred in binary mode.
Initial Remote Directory	Specify the default remote directory (path).
Initial Local Directory	Specify the default local directory (path).

26.7.4 FTP Restrictions

FTP will not work when:

- FTP service is disabled in the **Service Access Control** screen..
- The IP address(es) in the **Remote Management** screen does not match the client IP address. If it does not match, the switch will disconnect the Telnet session immediately.

CHAPTER 27

Diagnostic

This chapter explains the **Diagnostic** screen.

27.1 Diagnostic

Click **Management, Diagnostic** in the navigation panel to open this screen. Use this screen to check system logs, reset the system or ping IP addresses.

Figure 97 Diagnostic

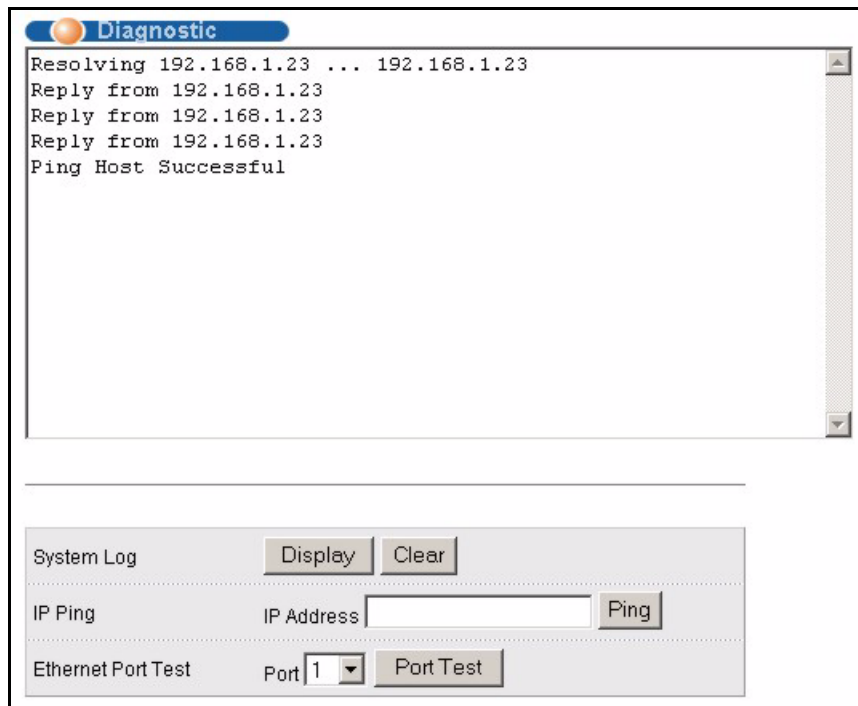

The following table describes the labels in this screen.

Table 60 Diagnostic

LABEL	DESCRIPTION
System Log	Click Display to display a log of events in the multi-line text box. Click Clear to empty the text box and reset the syslog entry.
IP Ping	Type the IP address of a device that you want to ping in order to test a connection. Click Ping to have the switch ping the IP address (in the field to the left).
Ethernet Port Test	From the Port drop-down list box, select a port number and click Port Test to perform internal loopback test.

CHAPTER 28

Cluster Management

This chapter introduces cluster management.

28.1 Overview

Cluster Management allows you to manage switches through one switch, called the cluster manager. The switches must be directly connected and be in the same VLAN group so as to be able to communicate with one another.

Table 61 ZyXEL Clustering Management Specifications

Maximum number of cluster members	24
Cluster Member Models	Must be compatible with ZyXEL cluster management implementation.
Cluster Manager	The switch through which you manage the cluster member switches.
Cluster Members	The switches being managed by the cluster manager switch.

In the following example, switch **A** in the basement is the cluster manager and the other switches on the upper floors of the building are cluster members.

Figure 98 Clustering Application Example

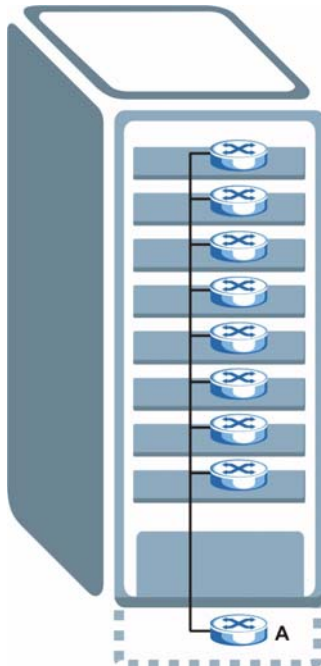

28.2 Cluster Management Status

Click **Management**, **Cluster Management** in the navigation panel to display the following screen.

Note: A cluster can only have one manager.

Figure 99 Cluster Management: Status

Clustering Management Status		Configuration		
Status	Manager			
Manager	00:13:49:00:00:02			
The Number Of Member = 1				
Index	MacAddr	Name	Model	Status
1	00:a0:c5:01:23:46		GS-2024	Online

The following table describes the labels in this screen.

Table 62 Cluster Management: Status

LABEL	DESCRIPTION
Status	This field displays the role of this switch within the cluster. Manager Member (you see this if you access this screen in the cluster member switch directly and not via the cluster manager) None (neither a manager nor a member of a cluster)
Manager	This field displays the cluster manager switch's hardware MAC address.
The Number of Member	This field displays the number of switches that make up this cluster. The following fields describe the cluster member switches.
Index	You can manage cluster member switches via the cluster manager switch. Each number in the Index column is a hyperlink leading to the cluster member switch's web configurator (see Figure 100 on page 189).
MacAddr	This is the cluster member switch's hardware MAC address.
Name	This is the cluster member switch's System Name .
Model	This field displays the model name.
Status	This field displays: Online (the cluster member switch is accessible) Error (for example the cluster member switch password was changed or the switch was set as the manager and so left the member list, etc.) Offline (the switch is disconnected - Offline shows approximately 1.5 minutes after the link between cluster member and manager goes down)

28.2.1 Cluster Member Switch Management

Go to the **Clustering Management Status** screen of the cluster manager switch and then select an **Index** hyperlink from the list of members to go to that cluster member switch's web configurator home page. This cluster member web configurator home page and the home page that you'd see if you accessed it directly are different.

Figure 100 Cluster Management: Cluster Member Web Configurator Screen

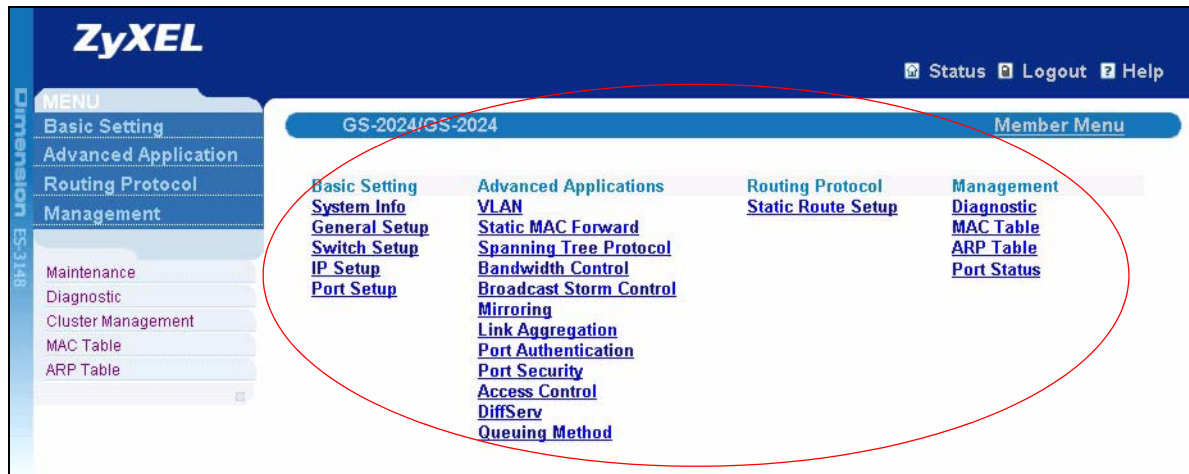

28.2.1.1 Uploading Firmware to a Cluster Member Switch

You can use FTP to upload firmware to a cluster member switch through the cluster manager switch as shown in the following example.

Figure 101 Example: Uploading Firmware to a Cluster Member Switch

```

C:\>ftp 192.168.1.1
Connected to 192.168.1.1.
220 ES-3148 FTP version 1.0 ready at Thu Jan  1 00:58:46 1970
User (192.168.0.1:(none)): admin
331 Enter PASS command
Password:
230 Logged in
ftp> ls
200 Port command okay
150 Opening data connection for LIST
--w--w--w-  1 owner   group      3042210 Jul  01 12:00 ras
-rw-rw-rw-  1 owner   group      393216  Jul  01 12:00 config
--w--w--w-  1 owner   group           0 Jul  01 12:00 fw-00-a0-c5-01-23-46
-rw-rw-rw-  1 owner   group           0 Jul  01 12:00 config-00-a0-c5-01-23-46
226 File sent OK
ftp: 297 bytes received in 0.00Seconds 297000.00Kbytes/sec.
ftp> bin
200 Type I OK
ftp> put 360lt0.bin fw-00-a0-c5-01-23-46
200 Port command okay
150 Opening data connection for STOR fw-00-a0-c5-01-23-46
226 File received OK
ftp: 262144 bytes sent in 0.63Seconds 415.44Kbytes/sec.
ftp>

```

The following table explains some of the FTP parameters.

Table 63 FTP Upload to Cluster Member Example

FTP PARAMETER	DESCRIPTION
User	Enter "admin".
Password	The web configurator password default is 1234.
ls	Enter this command to list the name of cluster member switch's firmware and configuration file.
360lt0.bin	This is the name of the firmware file you want to upload to the cluster member switch.
fw-00-a0-c5-01-23-46	This is the cluster member switch's firmware name as seen in the cluster manager switch.
config-00-a0-c5-01-23-46	This is the cluster member switch's configuration file name as seen in the cluster manager switch.

28.3 Configuring Cluster Management

Click **Configuration** from the **Cluster Management** screen to display the next screen.

Figure 102 Clustering Management Configuration

Clustering Management Configuration
[Status](#)

Clustering Manager:

Active	<input checked="" type="checkbox"/>
Name	<input type="text" value="Master"/>
VID	<input type="text" value="1"/>

Clustering Candidate:

List	<input type="text" value="00:a0:c5:01:23:46/GS-2024/"/>
Password	<input type="text"/>

Index	MacAddr	Name	Model	Remove

The following table describes the labels in this screen.

Table 64 Clustering Management Configuration



LABEL	DESCRIPTION
Clustering Manager	
Active	Select Active to have this switch become the cluster manager switch. A cluster can only have one manager. Other (directly connected) switches that are set to be cluster managers will not be visible in the Clustering Candidates list. If a switch that was previously a cluster member is later set to become a cluster manager, then its Status is displayed as Error in the Cluster Management Status screen and a warning icon () appears in the member summary list below.
Name	Type a name to identify the Clustering Manager . You may use up to 20 printable characters (no spaces are allowed).
VID	This is the VLAN ID and is only applicable if the switch is set to 802.1Q VLAN. All switches must be directly connected and in the same VLAN group to belong to the same cluster. Switches that are not in the same VLAN group are not visible in the Clustering Candidates list. This field is ignored if the Clustering Manager is using Port-based VLAN.

Table 64 Clustering Management Configuration (continued)

LABEL	DESCRIPTION
Apply	Click Apply to save these changes to the switch.
Cancel	Click Cancel to begin configuring this part of the screen afresh.
Clustering Candidate	The following fields relate to the switches that are potential cluster members.
List	A list of suitable candidates found by auto-discovery is shown here. The switches must be directly connected. Directly connected switches that are set to be cluster managers will not be visible in the Clustering Candidate list. Switches that are not in the same management VLAN group will not be visible in the Clustering Candidate list.
Password	Each cluster member's password is its web configurator password. Select a member in the Clustering Candidate list and then enter its web configurator password. If that switch administrator changes the web configurator password afterwards, then it cannot be managed from the Cluster Manager . Its Status is displayed as Error in the Cluster Management Status screen and a warning icon () appears in the member summary list below. If multiple devices have the same password then hold [SHIFT] and click those switches to select them. Then enter their common web configurator password.
Add	Click Add to save this part of the screen to the switch.
Cancel	Click Cancel to begin configuring this part of the screen afresh.
Refresh	Click Refresh to perform auto-discovery again to list potential cluster members.
The next summary table shows the information for the clustering members configured.	
Index	This is the index number of a cluster member switch.
MacAddr	This is the cluster member switch's hardware MAC address.
Name	This is the cluster member switch's System Name .
Model	This is the cluster member switch's model name.
Remove	Select this checkbox and then click the Remove button to remove a cluster member switch from the cluster.
Cancel	Click Cancel to begin configuring this part of the screen afresh.

CHAPTER 29

MAC Table

This chapter introduces the **MAC Table** screen.

29.1 Overview

The **MAC Table** screen (a MAC table is also known as a filtering database) shows how frames are forwarded or filtered across the switch's ports. It shows what device MAC address, belonging to what VLAN group (if any) is forwarded to which port(s) and whether the MAC address is dynamic (learned by the switch) or static (manually entered in the **Static MAC Forwarding** screen).

The switch uses the MAC table to determine how to forward frames. See the following figure.

- 1 The switch examines a received frame and learns the port on which this source MAC address came.
- 2 The switch checks to see if the frame's destination MAC address matches a source MAC address already learned in the MAC table.
 - If the switch has already learned the port for this MAC address, then it forwards the frame to that port.
 - If the switch has not already learned the port for this MAC address, then the frame is flooded to all ports. Too much port flooding leads to network congestion.
 - If the switch has already learned the port for this MAC address, but the destination port is the same as the port it came in on, then it filters the frame.

Figure 103 MAC Table Flowchart

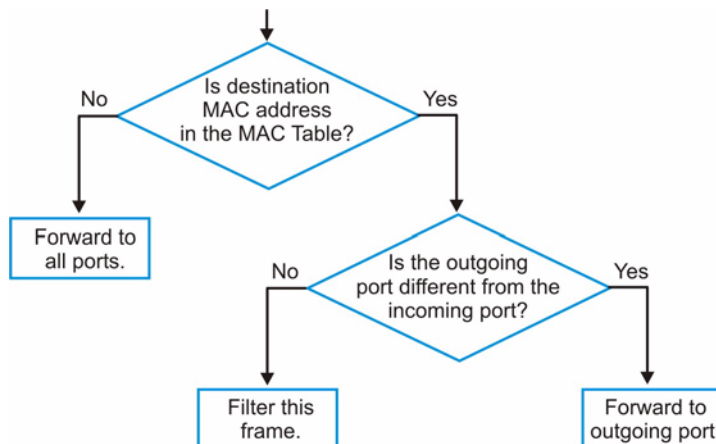

29.2 Viewing the MAC Table

Click **Management**, **MAC Table** in the navigation panel to display the following screen.

Figure 104 MAC Table

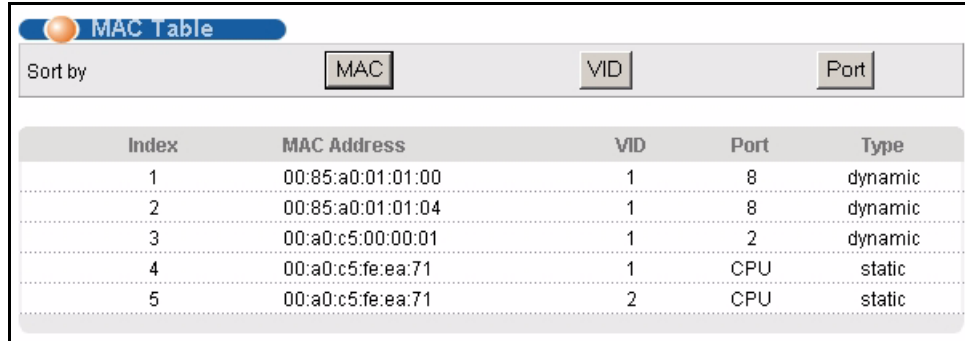

MAC Table					
Sort by					
		MAC	VID	Port	
Index	MAC Address	VID	Port	Type	
1	00:85:a0:01:01:00	1	8	dynamic	
2	00:85:a0:01:01:04	1	8	dynamic	
3	00:a0:c5:00:00:01	1	2	dynamic	
4	00:a0:c5:fe:ea:71	1	CPU	static	
5	00:a0:c5:fe:ea:71	2	CPU	static	

The following table describes the labels in this screen.

Table 65 MAC Table

LABEL	DESCRIPTION
Sort by	Click one of the following buttons to display and arrange the data according to that button type. The information is then displayed in the summary table below.
MAC	Click this button to display and arrange the data according to MAC address.
VID	Click this button to display and arrange the data according to VLAN group.
Port	Click this button to display and arrange the data according to port number.
Index	This is the incoming frame index number.
MAC Address	This is the MAC address of the device from which this incoming frame came.
VID	This is the VLAN group to which this frame belongs.
Port	This is the port from which the above MAC address was learned.
Type	This shows whether the MAC address is dynamic (learned by the switch) or static (manually entered in the Static MAC Forwarding screen).

CHAPTER 30

ARP Table

This chapter introduces ARP Table.

30.1 Overview

Address Resolution Protocol (ARP) is a protocol for mapping an Internet Protocol address (IP address) to a physical machine address, also known as a Media Access Control or MAC address, on the local area network.

An IP (version 4) address is 32 bits long. In an Ethernet LAN, MAC addresses are 48 bits long. The ARP Table maintains an association between each MAC address and its corresponding IP address.

30.1.1 How ARP Works

When an incoming packet destined for a host device on a local area network arrives at the switch, the switch's ARP program looks in the ARP Table and, if it finds the address, sends it to the device.

If no entry is found for the IP address, ARP broadcasts the request to all the devices on the LAN. The switch fills in its own MAC and IP address in the sender address fields, and puts the known IP address of the target in the target IP address field. In addition, the switch puts all ones in the target MAC field (FF.FF.FF.FF.FF.FF is the Ethernet broadcast address). The replying device (which is either the IP address of the device being sought or the router that knows the way) replaces the broadcast address with the target's MAC address, swaps the sender and target pairs, and unicasts the answer directly back to the requesting machine. ARP updates the ARP Table for future reference and then sends the packet to the MAC address that replied.

30.2 Viewing the ARP Table

Click **Management, ARP Table** in the navigation panel to open the following screen. Use the ARP table to view IP-to-MAC address mapping(s).

Figure 105 ARP Table

ARP Table			
Index	IP Address	MAC Address	Type
1	172.21.0.2	00:05:5d:04:30:f1	dynamic
2	172.21.3.16	00:05:1c:15:08:71	dynamic
3	172.21.3.19	00:0b:cd:8c:6d:ed	dynamic
4	172.21.3.40	00:0c:76:07:41:0d	dynamic
5	172.21.3.66	00:50:8d:47:73:4f	dynamic
6	172.21.3.90	00:05:5d:f4:49:20	dynamic
7	172.21.3.91	00:50:ba:ad:56:7c	dynamic
8	172.21.3.95	00:10:b5:ae:56:97	dynamic
9	172.21.3.120	00:10:b5:ae:62:32	dynamic
10	172.21.3.138	00:a0:c5:b2:62:26	dynamic
11	172.21.4.99	00:0c:76:09:cf:88	dynamic
12	172.21.10.11	08:00:20:ad:f6:88	dynamic
13	172.21.100.153	00:90:27:be:a2:8c	dynamic
14	172.21.207.247	00:0c:76:09:17:1a	dynamic
15	192.168.1.1	00:a0:c5:3f:91:56	dynamic
16	192.168.1.5	00:85:a0:01:01:04	dynamic
17	192.168.1.10	00:a0:c5:5e:df:f9	static
18	192.168.1.100	00:85:a0:01:01:00	dynamic

The following table describes the labels in this screen.

Table 66 ARP Table

LABEL	DESCRIPTION
Index	This is the ARP Table entry number.
IP Address	This is the learned IP address of a device connected to a switch port with corresponding MAC address below.
MAC Address	This is the MAC address of the device with corresponding IP address above.
Type	This shows whether the MAC address is dynamic (learned by the switch) or static (manually entered in the Static MAC Forwarding screen).

CHAPTER 31

Introducing the Commands

This chapter introduces the commands and gives a summary of commands available.

31.1 Overview

In addition to the web configurator, you can use line commands to configure the switch. Use line commands for advanced switch diagnosis and troubleshooting. If you have problems with your switch, customer support may request that you issue some of these commands to assist them in troubleshooting.

Note: See the web configurator parts of this User's Guide for background information on features configurable by the web configurator.

31.1.1 Switch Configuration File

When you configure the switch using either the CLI (Command Line Interface) or web configurator, the settings are saved as a series of commands in a configuration file on the switch. You can perform the following with a configuration file:

- Back up switch configuration once the switch is set up to work in your network.
- Restore switch configuration.
- Use the same configuration file to set all switches (of the same model) in your network to the same settings.

Note: You may also edit a configuration file using a text editor.

Make sure you use valid commands. The switch rejects configuration files with invalid or incomplete commands.

31.2 Accessing the CLI

You can use a direct console connection or Telnet to access the CLI on the switch.

Note: The switch automatically logs you out of the management interface after five minutes of inactivity. If this happens to you, simply log back in again.

31.2.1 Access Priority

- You can only access the CLI with the administrator account (the default username is **admin** and password is **1234**).
- By default, only one CLI management session is allowed via either the console port or Telnet. Console port access has higher priority.
- Use the `configure multi-login` command in the configuration mode to allow multiple concurrent logins. However, no more than five concurrent login sessions are allowed.

31.2.2 The Console Port

Connect to the switch's console port using a terminal emulation software configured to the following settings:

- VT100 terminal emulation
- 9600 bps
- No parity
- 8 data bits
- 1 stop bit
- No flow control

31.2.2.1 Initial Screen

When you turn on your switch, it performs several internal tests as well as line initialization. You can view the initialization information using the console port. After the initialization, the login screen displays (refer to [Section 31.3 on page 199](#)).

Figure 106 Initial Console Port Screen

```
Copyright (c) 1994 - 2005 ZyXEL Communications Corp.
initialize mgmt, ethernet address: 00:13:49:00:00:01
initialize switch, ethernet address: 00:13:49:00:00:02
Initializing switch unit 0...
Press ENTER to continue...
```

31.2.3 Telnet

Use the following steps to telnet into your switch.

- 1** For local management, connect your computer to the RJ-45 management port (labeled **MGMT**) on the switch.
- 2** Make sure your computer IP address and the switch IP address are on the same subnet. In Windows, click **Start** (usually in the bottom left corner), **Run** and then type `telnet 192.168.0.1` (the default management IP address) and click **OK**.

- 3 A login screen displays (refer to [Section 31.3 on page 199](#)).

31.3 The Login Screen

After you have successfully established a connection to the switch using a direct console connection or Telnet, a login screen displays as shown below. For your first login, enter the default administrator login username “admin” and password “1234”.

Figure 107 CLI: Login Screen

```
Enter User Name : admin
Enter Password : XXXX
```

31.4 Command Syntax Conventions

The rules of the commands are listed next.

- The command keywords are in `courier new` font.
- The required fields in a command are enclosed in angle brackets `<>`, for instance, `ping <ip>` means that you must specify an IP number for this command.
- The optional fields in a command are enclosed in square brackets `[]`, for instance,

```
configure snmp-server [contact <system contact>] [location
<system location>]
```

means that the `contact` and `location` fields are optional.

- “Command” refers to a command used in the command line interface (CLI command).
- The `|` symbol means “or”.
- The entry `<cr>` in the command lines refers to carriage return. Press [ENTER] or carriage return after a command to execute the command.
- Use the up (↑) or down (↓) arrow key to scroll through the command history list.
- You may enter a unique part of a command and press [TAB] to have the switch automatically display the full command. For example, if you enter “`config`” and press [TAB], the full command of “`configure`” automatically displays.
- Each interface refers to an Ethernet port on the switch. Commands configured after the interface command correspond to those ports.
- Type multiple ports or port ranges separated by a comma. Ranges of port numbers are typed separated by a dash.

31.5 Getting Help

The system includes a help facility to provide you with the following information about the commands:

- List of available commands under a command group.
- Detailed descriptions of the commands.

31.5.1 List of Available Commands

Enter “help” to display a list of available commands and the corresponding sub commands.

Enter “?” to display a list of commands you can use.

Figure 108 CLI Help: List of Commands: Example 1

```
ras> help
  Commands available:

  help
  logout
  exit
  history
  enable
  show ip <cr>
  show hardware-monitor <C|F>
  show system-information
  ping <ip|host-name> <cr>
  ping <ip|host-name> [vlan <vlan-id>][..]
  ping help
  traceroute <ip|host-name> <cr>
  traceroute <ip|host-name> [vlan <vlan-id>][..]
  traceroute help
  ssh <1|2> <[user@]dest-ip> <cr>
  ssh <1|2> <[user@]dest-ip> [command </>]
ras>
```

Figure 109 CLI Help: List of Commands: Example 2

```

ras> ?
  enable                Turn on privileged commands
  exit                  Exit from the EXEC
  help                  Description of the interactive help system
  history               Show a list of previously run commands
  logout                Exit from the EXEC
  ping                  Exec ping
  show                  Show system information
  ssh                   SSH client
  traceroute            Exec traceroute
ras>

```

31.5.2 Detailed Command Information

Enter `<command> help` to display detailed sub command and parameters.

Enter `<command> ?` to display detailed help information about the sub commands and parameters.

Figure 110 CLI Help: Detailed Command Information: Example 1

```

ras> ping help
  Commands available:

  ping <ip|host-name>
    <
      [ in-band|out-of-band|vlan <vlan-id> ]
      [ size <0-1472> ]
      [ -t ]
    >
ras>

```

Figure 111 CLI: Help: Detailed Command Information: Example 2

```

ras> ping ?
  <ip|host-name>      destination ip address
  help                Description of ping help
ras>

```

31.6 Command Modes

There are three CLI command modes: User, Enable and Configure.

When you first log into the CLI, the initial command mode is the User mode. The User mode commands are a subset of the Enable mode commands. The User mode command prompt ends with an angle bracket (>).

To enter Enable (or privileged) mode, type `enable` and enter a password when prompted (the default is 1234). When you enter the Enable mode, the command prompt changes to the pound sign (#).

To enter the configuration mode, type `configure` or `config`. The Configure mode command prompt consists of the word “`config`” and the pound sign (#). There are various sub configuration modes: interface, MVR and VLAN.

- To enter config-vlan mode, type `vlan` followed by a number (between 1 to 4094). For example, `vlan 10` to configure settings for VLAN 10.
- To enter config-interface mode and configure the ports, enter `interface port-channel` followed by a port number. For example, `interface port-channel 10`.
- To enter MVR mode, enter `mvr` followed by a VLAN ID (between 1 and 4094). For example, enter `mvr 2` to configure multicast settings on VLAN 2.

Enter `exit` or `logout` to quit from the current mode or log out from the CLI.

31.7 Using Command History

The switch keeps a list of up to 256 commands(s) you have entered for the current CLI session. You can use any commands in the history again by pressing the up (▲) or down (▼) arrow key to scroll through the previously used commands and press [ENTER]. Use the history command to display the list of commands.

Figure 112 CLI: History Command Example

```
ras> history
  enable
  exit
  show ip
  history
ras>
```

31.8 Saving Your Configuration

After you set the switch settings with the configuration commands, use the `write memory` command to save the changes permanently.

Figure 113 CLI: write memory

```

ras# write memory

```

Note: The `write memory` command is not available in User mode.

You must save your changes after each CLI session. All unsaved configuration changes are lost once you restart the switch.

31.8.1 Logging Out

In User mode, enter the `exit` or `logout` command to log out of the CLI.

31.9 Command Summary

The following sections summarize the commands available in the switch together with a brief description of each command. Commands listed in the tables are in the same order as they are displayed in the CLI. See the related section in the User's Guide for more background information.

31.9.1 User Mode

The following table describes the commands available for User mode.

Table 67 Command Summary: User Mode

COMMAND		DESCRIPTION
help		Displays help information.
logout		Exits from the CLI.
exit		Logs out from the CLI.
history		Displays a list of previously command(s) that you have executed. The switch stores up to 256 commands in history.
enable		Accesses Enable (or privileged) mode. See Section 31.9.2 on page 204 .
show	ip	Displays IP related information.
	hardware-monitor <C F>	Displays current hardware monitor information with the specified temperature unit (Celsius C or Fahrenheit F).
	system-information	Displays general system information.
ping	<IP host-name>	Sends Ping request to an Ethernet device.
	<IP host-name> [vlan <vlan-id>] [size <0-1472>] [-t]	Sends Ping request to an Ethernet device in the specified VLAN(s) with the specified parameters.

Table 67 Command Summary: User Mode (continued)

COMMAND		DESCRIPTION
	help	Displays command help information.
traceroute	<ip host-name>	Determines the path a packet takes to a device.
	<ip host-name> [vlan <vlan-id>] [ttl <1-255>] [wait <1-60>] [queries <1-10>]	Determines the path a packet takes to a device in a VLAN.
	help	Displays command help information.
ssh	<1 2> <[user@]dest-ip>	Connects to an SSH server with the specified SSH version.

31.9.2 Enable Mode

The following table describes the commands available for Enable mode.

Table 68 Command Summary: Enable Mode

COMMAND		DESCRIPTION	
help		Displays help information.	
logout		Exits Enable (or privileged) mode.	
exit		Exits Enable (or privileged) mode.	
history		Displays a list of command(s) that you have previously executed.	
enable		Accesses Enable (or privileged) mode.	
disable		Exits Enable (or privileged) mode.	
configure		Accesses Configuration mode. See Section 31.9.3 on page 208 .	
no	logging	Disables syslog logging.	
	arp	Flushes the ARP (Address Resolution Protocol) table.	
	interface <port-number>	Clears the interface status of the specified port(s).	
show	ip	Displays IP related information.	
		arp	Displays the ARP table.
		route	Displays IP routing information.
		route static	Displays IP static route information.
	hardware-monitor <C F>		Displays current hardware monitor information with the specified temperature unit (Celsius C or Fahrenheit F).
	system-information		Displays general system information.
	vlan1q	gvrp	Displays GVRP settings.
		port-isolation	Displays port isolation settings.

Table 68 Command Summary: Enable Mode (continued)

COMMAND			DESCRIPTION
	spanning-tree	config	Displays Spanning Tree Protocol (STP) settings.
	mac	address-table <all [mac vid port]>	Displays MAC address table. You can sort by MAC address, VID or port.
		address-table static	Displays static MAC address table.
	lacp		Displays LACP (Link Aggregation Control Protocol) settings.
	trunk		Displays link aggregation information.
	radius-server		Displays RADIUS server settings.
	port-access-authenticator		Displays all port authentication settings.
		<port-list>	Displays port authentication settings on the specified port(s).
	port-security		Displays all port security settings.
		<port-list>	Displays port security settings on the specified port(s).
	snmp-server		Displays SNMP settings.
	logins		Displays login account information.
	service-control		Displays service control settings.
	remote-management		Displays all secured client information.
		<index>	Displays the specified secured client information.
	classifier		Displays all classifier related information.
		<name>	Displays the specified classifier related information.
	policy		Displays all policy related information.
		<name>	Displays the specified policy related information.
	interface <port-number>		Displays current interface status.
	interfaces config <port-list>		Displays current interface configuration.
		bandwidth-control	Displays bandwidth control settings.
		egress	Displays outgoing port information.
		bstorm-control	Displays broadcast storm control settings.
		igmp-immediate-leave	Displays IGMP immediate leave settings.
		igmp-filtering	Displays IGMP filter profile settings.

Table 68 Command Summary: Enable Mode (continued)

COMMAND			DESCRIPTION
		igmp-group-limited	Displays IGMP group settings.
		igmp-query-mode	Displays IGMP query mode settings on the port(s).
	vlan		Displays the status of all VLANs.
		<vlan-id>	Displays the status of the specified VLAN.
	running-config		Displays current operating configuration.
	timesync		Displays time server information.
	time		Displays current system time and date.
	garp		Displays GARP information.
	loginPrecedence		Displays login precedence settings.
	logging		Displays system logs.
	vlan-stacking		Displays VLAN stacking configuration.
	ssh		Displays general SSH settings.
		known-hosts	Displays known SSH hosts information.
		key <rsa rsa dsa>	Displays internal SSH public and private key information.
		session	Displays current SSH session(s).
	https		Displays the HTTPS information.
		session	Displays current HTTPS session(s).
		certificate	Displays the HTTPS certificates.
		key <rsa dsa>	Displays the HTTPS key.
		timeout	Displays the HTTPS session timeout.
	multi-login		Displays multi-login information
	plt		Displays Packet Loop Test (PLT).
	mac-aging-time		Displays MAC learning aging time.
	cluster		Displays cluster management status.
		candidates	Displays cluster candidate information.
		member	Displays the MAC address of the cluster member(s).
		member mac <mac-addr>	Displays the status of the cluster member(s).
		members config	Displays the configuration of the cluster member(s).
	igmp-filtering profile		Displays IGMP filter profile settings.
	igmp-snooping		Displays IGMP snooping settings.
	multicast		Displays multicast settings.

Table 68 Command Summary: Enable Mode (continued)

COMMAND		DESCRIPTION
	mvr	Displays all MVR (Multicast VLAN Registration) settings.
		<vlan-id>
		Displays specified MVR information.
igmp-flush		Removes all IGMP information.
mac-flush		Clears the MAC address table.
	<port-num>	Removes all learned MAC address on the specified port(s).
erase	running-config	Resets to the factory default settings.
baudrate	<1 2 3 4 5>	Changes the console port speed. Choices are 1 (9600), 2 (19200), 3(38400), 4 (57600) and 5 (115200).
boot	config <index>	Restarts the system with the specified configuration file.
reload	config <index>	Restarts the system and use the specified configuration file.
write	memory	Saves current configuration to the configuration file the switch is currently using.
		<index>
		Saves current configuration to the specified configuration file on the switch.
copy	tftp flash <ip> <remote-file>	Restores firmware via TFTP.
	tftp config <index> <ip> <remote-file>	Restores configuration with the specified filename from the specified TFTP server.
	running-config tftp <ip> <remote-file>	Backs up running configuration to the specified TFTP server with the specified file name.
ping	<ip host-name>	Sends Ping request to an Ethernet device.
		[vlan <vlan-id>][..]
		Sends Ping request to an Ethernet device in the specified VLAN(s).
	help	Displays command help information.
traceroute	<ip host-name> [in-band out-of-band vlan <vlan-id>][ttl <1-255>] [wait <1-60>] [queries <1-10>]	Determines the path a packet takes to a device.
	help	Displays command help information.
ssh	<1 2> <[user@]dest-ip>	Connects to an SSH server with the specified SSH version.
		[command </>]
		Connects to an SSH server with the specified SSH version and addition commands to be executed on the server.

31.9.3 General Configuration Mode

The following table lists the commands in Configuration (or Config) mode.

Table 69 Command Summary: Configuration Mode

COMMAND		DESCRIPTION	
help		Displays help information.	
logout		Exits from the CLI.	
history		Displays a list of previous command(s) that you have executed.	
exit		Exits from the CLI.	
mode	zynos	Changes the CLI mode to the ZyNOS format.	
password	<password>	Change the password for Enable mode.	
no	ip	Sets the management IP address to the default value.	
		route <ip> <mask>	Removes a specified IP static route.
		route <ip> <mask> inactive	Enables a specified IP static route.
	igmp-filtering		Clears the IGMP filtering settings on the switch.
		profile <name>	Deletes the IGMP filtering profile.
		profile <name> start-address <ip> end-address <ip>	Deletes a rule in the IGMP filtering profile.
	igmp-snooping		Disables IGMP snooping.
	mac-forward	mac <mac-addr> vlan <vlan-id> interface <interface-id>	Removes the specified MAC forwarding entry, belonging to a VLAN group (if any) forwarded through an interface(s).
		mac <mac-addr> vlan <vlan-id> interface <interface-id> inactive	Enables the specified MAC address, belonging to a VLAN group (if any) forwarded through an interface(s).
	mac-filter	mac <mac-addr> vlan <vlan-id> inactive	Enables the specified MAC-filter rule.
		mac <mac-addr> vlan <vlan-id>	Disables the specified MAC filter rule.
	mirror-port		Disables port mirroring on the switch.

Table 69 Command Summary: Configuration Mode (continued)

COMMAND		DESCRIPTION	
	lacp	Disables the link aggregation control protocol (dynamic trunking) on the switch.	
	trunk	<T1 T2 T3 T4 T5 T6>	Disables the specified trunk group.
		<T1 T2 T3 T4 T5 T6> lacp	Disables LACP in the specified trunk group.
		<T1 T2 T3 T4 T5 T6> interface <port-list>	Removes ports from the specified trunk group.
	bcp-transparency		Disables Bridge Control Protocol (BCP) transparency.
	storm-control		Disables broadcast storm control.
	bandwidth-control		Disable bandwidth control on the switch.
	vlanlq	gvrp	Disables GVRP on the switch.
		port-isolation	Disables port isolation.
	spanning-tree		Disables STP.
		<port-list>	Disables STP on listed ports.
	timesync		Disables timeserver settings.
	radius-server		Disables the use of authentication from the RADIUS server.
	port-access-authenticator		Disables port authentication on the switch.
		<port-list>	Disables authentication on the listed ports.
		<port-list> reauthenticate	Disables the re-authentication mechanism on the listed port(s).
	port-security		Disables port security on the switch.
		<port-list>	Disables port security on the specified ports.
		<port-list> learn inactive	Enables MAC address learning on the specified ports.
	snmp-server	trap-destination <ip>	Disables sending of SNMP traps to a station.
	logins	<name>	Disables login access to the specified name.
	service-control	telnet	Disables telnet access to the switch.
		ftp	Disables FTP access to the switch.

Table 69 Command Summary: Configuration Mode (continued)

COMMAND			DESCRIPTION
		http	Disables web browser control to the switch.
		ssh	Disables SSH (Secure Shell) server access to the switch.
		https	Disables secure web browser access to the switch.
		icmp	Disables ICMP access to the switch such as pinging and tracerouting.
		snmp	Disables SNMP management.
	remote-management	<index>	Clears a secure client set entry from the list of secure clients.
		<index> service <[telnet] [ftp] [http] [icmp] [snmp] [ssh] [https]>	Disables a secure client set entry number from using the selected remote management service(s).
	classifier	<name>	Disables the classifier. Each classifier has one rule. If you disable a classifier you cannot use policy rule related information.
		<name> inactive	Enables a classifier.
	policy	<name>	Deletes the policy. A policy sets actions for classifier traffic.
		<name> inactive	Enables a policy.
	vlan	<vlan-id>	Deletes the static VLAN entry.
	dhcp-relay		Disables DHCP relay.
		option	Disables the relay agent information option 82.
		information	System name is not appended to option 82 information field.
	vlan-stacking		Disables VLAN stacking.
	ssh	key <rsa1 rsa dsa>	Disables the secure shell server encryption key. Your switch supports SSH versions 1 and 2 using RSA and DSA authentication.
		known-hosts	Removes all remote hosts.
		known-hosts <host-ip>	Removes the specified remote hosts from the list of all known hosts.
		known-hosts <host-ip> [1024 ssh- rsa ssh-dsa]	Removes remote known hosts with the specified public key (1024-bit RSA1, RSA or DSA).

Table 69 Command Summary: Configuration Mode (continued)

COMMAND			DESCRIPTION
	https	timeout	Resets the session timeout to the default of 300 seconds.
	multi-login		Disables another administrator from logging into Telnet or the CLI.
	cluster		Disables cluster management on the switch.
	cluster member	<mac-address>	Removes the cluster member.
	mvr	<vlan-id>	Disables MVR on the switch.
	wfq fe-spq		Sets the switch to use WFQ to service all queues for the 10/100Mbps Ethernet port.
vlan	<1-4094>		Enters the VLAN configuration mode. See Section 31.9.5 on page 221 for more information.
vlan-type	<802.1q port-based>		Specifies the VLAN type.
igmp-snooping			Enables IGMP snooping.
	unknown-multicast-frame <drop flooding>		Sets how to treat traffic from unknown multicast group.
igmp-filtering			Enables IGMP filtering on the switch.
	profile <name> start-address <ip> end-address <ip>		Sets the range of multicast address(es) in a profile.
interface	port-channel <port-list>		Enables a port or a list of ports for configuration. See Section 31.9.4 on page 218 for more details.
spq			Sets the queuing method to SPQ (Strictly Priority Queuing).
wfq			Sets the queuing method to WFQ (Weighted Fair Queuing).
	fe-spq <Q0-Q7>		Sets the switch to use SPQ to service the subsequent queue(s) after and including the specified queue for the 10/100 Mbps Ethernet ports.
ip	route	<ip> <mask> <next-hop-ip>	Creates a static route.
		<ip> <mask> <next-hop-ip> [metric <metric>] [name <name>] [inactive]	Sets the metric of a static route or deactivates a static route.
	name-server	<ip>	Sets the IP address of a domain name server.

Table 69 Command Summary: Configuration Mode (continued)

COMMAND			DESCRIPTION
	address default-gateway	<ip>	Sets the default gateway's IP address for the out-of-band management port.
	address	<ip> <mask>	Sets the IP address and subnet mask of the out-of-band management port.
mac-forward	name <name> mac <mac-addr> vlan <vlan-id> interface <interface-id>		Configures a static MAC address forwarding rule.
		inactive	Disables a static MAC address forwarding rule.
mac-filter	name <name> mac <mac-addr> vlan <vlan-id> drop <src/dst/both>		Configures a static MAC address port filtering rule.
		inactive	Disables a static MAC address port filtering rule.
mirror-port			Enables port mirroring.
	<port-num>		Sets a monitor port (the port to which traffic is copied for analysis).
lacp			Enables Link Aggregation Control Protocol (LACP).
	system-priority	<1-65535>	Sets the priority of an active port using LACP.
trunk	<T1 T2 T3 T4 T5 T6>		Activates a trunk group.
	<T1 T2 T3 T4 T5 T6> lacp		Enables LACP for a trunk group.
	<T1 T2 T3 T4 T5 T6> interface <port-list>		Adds a port(s) to the specified trunk group.
	interface <port-list> timeout <lacp-timeout>		Defines the port number and LACP timeout period.
cluster	<vlan-id>		Sets the cluster management VLAN ID.
	name <cluster name>		Configures a name to identify the cluster manager.
	member <mac-address> password <password-str>		Sets the cluster member switch's hardware MAC address and password.
	rcommand <mac-address>		Logs into a cluster member switch.

Table 69 Command Summary: Configuration Mode (continued)

COMMAND		DESCRIPTION
classifier	<pre> <name> <[packet-format <802.3untag 802.3tag EtherIIuntag EtherI Itag>] [priority<0-7>] [vlan <vlan-id>] [ethernet-type <ether- num ip ipx arp rarp appletalk decnet sna netbios dlc>] [source-mac <src- mac-addr>] [source-port <port- num>] [destination-mac <dest-mac-addr>] [dscp <0-63>] [ip-protocol <protocol- num tcp udp icmp egp ospf rsvp igmp igp pim ipsec> [establish-only]] [source-ip <src-ip- addr> [mask-bits <mask-bits>]] [source-socket <socket-num>] [destination-ip <dest-ip-addr> [mask-bits <mask- bits>]] [destination-socket <socket-num>] [inactive] > </pre>	Configures a classifier. A classifier groups traffic into data flows according to specific criteria such as the source address, destination address, source port number, destination port number or incoming port number.

Table 69 Command Summary: Configuration Mode (continued)

COMMAND		DESCRIPTION
policy	<pre><name> classifier <classifier-list> < [vlan<vlan-id>] [egress-port <port- num>] [priority <0-7>] [dscp <0-63>] [tos <0-7>] [bandwidth <bandwidth>] [outgoing-packet- format <tagged untagged>] [out-of-profile- dscp <0-63>] [forward-action <drop forward>] [queue-action <prio-set prio- queue prio-replace- tos>] [diffserv-action <diff-set-tos diff- replace- priority diff-set- dscp>] [outgoing-mirror] [outgoing-eport] [outgoing-non- unicast-eport] [outgoing-set-vlan] [metering] [out-of-profile- action <[change- dscp][drop][forward][set-drop- prec]>][inactive] ></pre>	<p>Configures a policy. A classifier distinguishes traffic into flows based on the configured criteria. A policy rule ensures that a traffic flow gets the requested treatment in the network.</p>
radius-server	<pre>host <ip> [acct-port <socket-number>] [key <key-string>]</pre>	<p>Sets the IP address and/or the port number and key of the external RADIUS server.</p>
port-access- authenticator		<p>Enables 802.1x authentication on the switch.</p>
	<port-list>	<p>Enables 802.1x authentication on the specified port(s).</p>
		<pre>reauthenticate</pre> <p>Sets a subscriber to periodically re-enter his or her username and password to stay connected to a specified port.</p>
		<pre>reauth-period <reauth-period></pre> <p>Specifies how often a client has to re-enter the username and password to stay connected to the specified port(s).</p>

Table 69 Command Summary: Configuration Mode (continued)

COMMAND		DESCRIPTION
port-security		Enables port security on the switch.
	<port-list>	Enables the port security feature on the specified port(s).
	learn inactive	Disables MAC address learning on the specified port(s).
	address-limit <number>	Limits the number of (dynamic) MAC addresses that may be learned on a port.
	MAC-freeze	Disables MAC address learning and enables port security. Note: All previously learned dynamic MAC addresses are saved to the static MAC address table.
vlanlq	gvrp	Enables GVRP.
	port-isolation	Enables port-isolation.
garp	join <100-65535> leave <msec> leaveall <msec>	Configures GARP time settings.
spanning-tree		Enables STP on the switch.
	priority <0-61440>	Sets the bridge priority of the switch.
	hello-time <1-10> maximum-age <6-40> forward-delay <4-30>	Sets Hello Time, Maximum Age and Forward Delay.
	<port-list>	Enables STP on a specified port.
	<port-list> path-cost <1-65535>	Sets the STP path cost for a specified port.
	<port-list> priority <0-255>	Sets the priority for a specified port.
	help	Displays help information.
hostname	<name_string>	Sets the switch's name for identification purposes.
time	<Hour:Min:Sec>	Sets the time in hour, minute and second format.
	timezone <-1200 ... 1200>	Selects the time difference between UTC (formerly known as GMT) and your time zone.
	date <month/day/year>	Sets the date in year, month and day format.
	help	Displays help information.

Table 69 Command Summary: Configuration Mode (continued)

COMMAND		DESCRIPTION
timesync	<daytime time ntp>	Sets the time server protocol.
	server <ip>	Sets the IP address of your time server.
loginPrecedence	<LocalOnly LocalRADIUS RADIUSOnly>	Select which database the switch should use (first) to authenticate a user.
bcp-transparency		Enables Bridge Control Protocol (BCP) transparency.
queue	level <0-7> priority <0-7>	Sets the priority level-to-physical queue mapping.
storm-control		Enables broadcast storm control on the switch.
bandwidth-control		Enables bandwidth control.
mac-aging-time	<10-3000>	Sets learned MAC aging time.
snmp-server	get-community <property>	Sets the get community.
	set-community <property>	Sets the set community.
	trap-community <property>	Sets the trap community.
	trap-destination <ip>	Sets the IP addresses of up to four stations to send your SNMP traps to.
	[contact <system contact>] [location <system location>]	Sets the geographic location and the name of the person in charge of this switch.
logins	username <name> password <pwd>	Configures up to four read-only login accounts.
service-control	icmp	Allows ICMP access for services such as Ping.
	snmp	Allows SNMP management.
	http <socket-number> <timeout>	Allows HTTP access on the specified service port and defines the timeout period.
	telnet <socket-number>	Allows Telnet access on the specified service port.
	ftp <socket-number>	Allows FTP access on the specified service port.
	ssh <socket-number>	Allows SSH access on the specified service port.
	https <socket-number>	Allows HTTPS access on the specified service port.
remote-management	<index>	Enables a specified secured client set.

Table 69 Command Summary: Configuration Mode (continued)

COMMAND		DESCRIPTION
	<index> start-addr <ip> end-addr <ip> service <[telnet] [ftp] [http] [icmp] [snmp] [ssh] [https]>	Specifies a group of trusted computer(s) from which an administrator may use a service to manage the switch.
admin-password	<pw-string> <confirm-string>	Changes the administrator password.
vlan-stacking		Enables VLAN stacking on the switch.
	<SPTPID>	Sets the SP TPID (Service Provider Tag Protocol Identifier).
default-management	<in-band out-of-band>	Specifies through which traffic flow the switch is to send packets.
ssh	known-hosts <host-ip> <1024 ssh-rsa ssh-dsa> <key>	Adds a remote host to which the switch can access using SSH service.
https	cert-regeneration <rsa dsa>	Re-generates a certificate.
	timeout <0-65535>	Sets the HTTPS timeout period.
multi-login		Enables multi-login.
mvr <vlan-id>		Enters the MVR (Multicast VLAN Registration) configuration mode. See Section 31.9.6 on page 223 for more information.
dhcp-relay		Enables DHCP relay.
	helper-address <svr_ip> [svr2_ip] [svr3_ip]	Sets the IP addresses of up to 3 DHCP servers.
	option	Allows the switch to add DHCP relay agent information.
	information	Allows the switch to add system name to agent information.

31.9.4 interface port-channel Commands

The following table lists the `interface port-channel` commands in configuration mode. Use these commands to configure the ports.

Table 70 interface port-channel Commands

COMMAND		DESCRIPTION
<code>interface port-channel <port-list></code>		Enables a port or a list of ports for configuration.
	<code>weight <wt1> <wt2> ... <wt8></code>	Sets the interface to use WFQ weighting. A weight value of one to eight is given to each variable from wt 1 to wt 8.
	<code>egress set <port-list></code>	Sets the outgoing traffic port list for a port-based VLAN.
	<code>igmp-immediate-leave</code>	Enables IGMP immediate leave on the port.
	<code>igmp-filtering profile <name></code>	Sets the IGMP filtering profile for this port.
	<code>igmp-group-limited</code>	Limits the number of multicast groups.
	<code>igmp-group-limited number <number></code>	Sets the number of multicast groups this port is allowed to join.
	<code>igmp-querier-mode <auto fixed edge></code>	Sets the IGMP querier mode of a port. Selects <code>auto</code> to treat the IGMP queries normally, <code>fixed</code> to always treat the port as a querier port no matter there is a query or <code>edge</code> to treat the port as a non-querier port which drops any IGMP queries received.
	<code>pvid <1-4094></code>	The default PVID is VLAN 1 for all ports. Sets a PVID in the range 1 to 4094 for the specified interface.
	<code>ingress-check</code>	Enables the device to discard incoming frames for VLANs that are not included in a port member set.
	<code>gvrp</code>	Enables this function to permit VLAN groups beyond the local switch.
	<code>frame-type <all tagged></code>	Choose to accept both tagged and untagged incoming frames or just tagged incoming frames on a port.

Table 70 interface port-channel Commands (continued)

COMMAND		DESCRIPTION	
	name <port-name-string>	Sets a name for the port(s). Enter a descriptive name (up to nine printable ASCII characters).	
	vlan-trunking	Enables VLAN Trunking on ports connected to other switches or routers (but not ports directly connected to end users) to allow frames belonging to unknown VLAN groups to pass through the switch.	
	flow-control	Enables interface flow control. Flow control regulates transmissions to match the bandwidth of the receiving port.	
	bandwidth-limit	Enables bandwidth control on the port(s).	
		ingress <Kbps>	Sets the maximum bandwidth allowed for incoming traffic on the port(s).
		cir <Kbps>	Sets the guaranteed bandwidth allowed for incoming traffic on the port(s).
		pir <Kbps>	Sets the maximum bandwidth allowed for incoming traffic on the port(s).
		egress <Kbps>	Sets the maximum bandwidth allowed for outgoing traffic on the port(s).
	broadcast-limit	Enables broadcast storm control limit on the switch.	
		<pkt/s>	Sets how many broadcast packets the interface receives per second.
	multicast-limit	Enables the interface multicast limit.	
		<pkt/s>	Sets how many multicast packets the interface receives per second.
	dlf-limit	Enables the Destination Lookup Failure (DLF) limit.	
		<pkt/s>	Sets the interface DLF limit in packets per second (pps).
	qos priority	<0 .. 7>	Sets the quality of service priority for an interface.
	mirror		Enables port mirroring in the interface.

Table 70 interface port-channel Commands (continued)

COMMAND		DESCRIPTION
		dir <ingress egress both> Enables port mirroring for incoming, outgoing or both incoming and outgoing traffic. Port mirroring copies traffic from one or all ports to another or all ports for external analysis.
	speed-duplex	<auto 10-half 10-full 100-half 100-full 1000-full> Sets the duplex mode (half or full) and speed (10, 100 or 1000 Mbps) of the connection on the interface. Selecting auto (auto-negotiation) makes one port able to negotiate with a peer automatically to obtain the connection speed and duplex mode that both ends support.
	bpdu-control <peer tunnel discard network>	Sets how Bridge Protocol Data Units (BPDUs) are used in STP port states.
	no	egress set <port-list> Disables the outgoing traffic port list for a port-based VLAN.
		igmp-immediate-leave Disables IGMP immediate leave on the port.
		igmp-filtering profile Disables IGMP filtering on the port.
		igmp-group-limited Disables IGMP group limitation.
		ingress-check Disables ingress checking on the port(s).
		gvrp Disable GVRP on the port(s).
		flow-control Disables flow control on the port(s).
		vlan-trunking Disables VLAN trunking on the port(s).
		mirror Disables port mirroring on the port(s).
		bandwidth-limit Disables bandwidth limit on the port(s).
		broadcast-limit Disables broadcast storm control limit on the switch.
		multicast-limit Disables multicast limit on the switch.
		dlf-limit Disables destination lookup failure (DLF) limit on the switch.
		inactive Enables the port(s) on the switch.
		intrusion-lock Disables intrusion-lock on a port so that a port can be connected again after you disconnected the cable.

Table 70 interface port-channel Commands (continued)

COMMAND		DESCRIPTION
	inactive	Disables the specified port(s) on the switch.
	help	Displays a description of the interface port-channel commands.
	exit	Exits from the interface port-channel command mode.
	vlan-stacking role <normal access tunnel>	Sets the VLAN stacking port roles of the specified interface.
	vlan-stacking SPVID <1-4094>	Sets the service provider VID of the specified interface.
	vlan-stacking priority <0-7>	Sets the priority of the specified interface in VLAN stacking.
	cable_diagnostics	Displays whether a cable is connected to the port (good) or not (open).
	intrusion-lock	Enables intrusion lock on a port and a port cannot be connected again after you disconnected the cable.
	test	Performs an interface loopback test.

31.9.5 config-vlan Commands

The following table lists the `vlan` commands in configuration mode.

Table 71 Command Summary: config-vlan Commands

COMMAND		DESCRIPTION
vlan <1-4094>		Creates a new VLAN group.
	name <name-str>	Specifies a name for identification purposes.
	normal <port-list>	Specifies the port(s) to dynamically join this VLAN group using GVRP
	fixed <port-list>	Specifies the port(s) to be a permanent member of this VLAN group.
	forbidden <port-list>	Specifies the port(s) you want to prohibit from joining this VLAN group.
	untagged <port-list>	Specifies the port(s) you don't want to tag all outgoing frames transmitted with this VLAN Group ID.
	inactive	Disables the specified VLAN.
	help	Displays a list of available VLAN commands.

Table 71 Command Summary: config-vlan Commands (continued)

COMMAND			DESCRIPTION
	no	fixed <port-list>	Sets fixed port(s) to normal port(s).
		forbidden <port-list>	Sets forbidden port(s) to normal port(s).
		untagged <port-list>	Enables VLAN tagging for outgoing traffic on the specified port(s).
		inactive	Enables the specified VLAN.
		ip address inband-default dhcp-bootp	Sets the default in-band interface to use a static IP address in this VLAN. The switch will use the default IP address of 0.0.0.0 if you do not configure a static IP address.
		ip address <ip-address> <mask>	Deletes the IP address and subnet mask from this VLAN.
		ip address default-gateway	Deletes the default gateway from this VLAN.
	exit		Leaves the VLAN configuration mode.
	ip address	inband-default dhcp-bootp	Sets the dynamic in-band IP address
		inband-default dhcp-bootp release	Releases the dynamic in-band IP address.
		inband-default dhcp-bootp renew	Updates the dynamic in-band IP address.
		inband-default <ip-address> <mask>	Sets a static in-band IP address and subnet mask.
		<ip-address> <mask> manageable	Sets the management IP address and subnet mask of the switch in the specified VLAN.
		<ip-address> <mask>	Sets the IP address and subnet mask of the switch in the specified VLAN.
		default-gateway <ip-address>	Sets a default gateway IP address for this VLAN.

31.9.6 mvr Commands

The following table lists the `mvr` commands in configuration mode.

Table 72 mvr Commands

COMMAND		DESCRIPTION
<code>mvr <1-4094></code>		Enters the MVR (Multicast VLAN Registration) configuration mode.
	<code>source-port <port-list></code>	Sets the source port(s). An MVR source port can send and receive multicast traffic in a multicast VLAN.
	<code>receiver-port <port-list></code>	Sets the receiver port(s). An MVR receiver port can only receive multicast traffic in a multicast VLAN.
	<code>inactive</code>	Disables MVR settings.
	<code>mode <dynamic compatible></code>	Sets the MVR mode (dynamic or compatible).
	<code>name <name-str></code>	Sets the MVR name for identification purposes.
	<code>tagged <port-list></code>	Sets the port(s) to tag VLAN tags.
	<code>group <name-str></code> <code>start-address <ip></code> <code>end-address <ip></code>	Sets the multicast group range for the MVR.
	<code>exit</code>	Exist from the MVR configuration mode.
	<code>no source-port <port-list></code>	Disables the source port(s). An MVR source port can send and receive multicast traffic in a multicast VLAN.
	<code>no receiver-port <port-list></code>	Disables the receiver port(s). An MVR receiver port can only receive multicast traffic in a multicast VLAN.
	<code>no tagged <port-list></code>	Sets the port(s) to untag VLAN tags.
	<code>no inactive</code>	Enables MVR.
	<code>no group</code>	Disables all MVR group settings.
	<code>no group <name-str></code>	Disables the specified MVR group setting.

CHAPTER 32

Command Examples

This chapter describes some commands in more detail.

32.1 Overview

These are commands that you may use frequently in maintaining your switch.

32.2 show Commands

These are the commonly used `show` commands.

32.2.1 show system-information

Syntax:

```
show system-information
```

This command shows the general system information (such as the firmware version and system up time).

An example is shown next.

Figure 114 show system-information Command Example

```
ras> show system-information
System Name       : ES-3148
System Contact    :
System Location   :
Ethernet Address  : 00:13:49:00:00:02
ZyNOS F/W Version : V3.60(TZ.0)b0.1 | 05/24/2005
RomRasSize       : 3042210
System up Time    :      0:00:54 (1556 ticks)
Bootbase Version  : V0.6 | 05/02/2005
ZyNOS CODE        : RAS May 24 2005 09:22:08
Product Model     : ES-3148
ras>
```

32.2.2 show ip

Syntax:

```
show ip
```

This command displays the IP related information (such as IP address and subnet mask) on all switch interfaces.

The following figure shows the default interface settings.

Figure 115 show ip Command Example

```
ras> show ip
Out-of-band Management IP Address = 192.168.0.1
Management IP Address
    IP[192.168.0.1], Netmask[255.255.255.0], VID[0]
IP Interface
    IP[192.168.1.1], Netmask[255.255.255.0], VID[1]
ras>
```

32.2.3 show logging

Note: This command is not available in User mode.

Syntax:

```
show logging
```

This command displays the system logs. The following figure shows an example.

Figure 116 show logging Command Example

```
ras# show logging
 1 Thu Jan  1 00:02:08 1970 PP05 -WARN  SNMP TRAP 3: link up
 2 Thu Jan  1 00:03:14 1970      INFO  adjtime task pause 1 day
 3 Thu Jan  1 00:03:16 1970 PP0f -WARN  SNMP TRAP 26: Event On Trap
 4 Thu Jan  1 00:03:16 1970 PINI -WARN  SNMP TRAP 1: warm start
 5 Thu Jan  1 00:03:16 1970 PINI -WARN  SNMP TRAP 3: link up
 6 Thu Jan  1 00:03:16 1970 PINI  INFO  main: init completed
 7 Thu Jan  1 00:00:13 1970 PP26  INFO  adjtime task pause 1 day
 8 Thu Jan  1 00:00:14 1970 PP0f -WARN  SNMP TRAP 26: Event On Trap
 9 Thu Jan  1 00:00:14 1970 PINI -WARN  SNMP TRAP 0: cold start
10 Thu Jan  1 00:00:14 1970 PINI  INFO  main: init completed
11 Thu Jan  1 00:00:04 1970 PP05 -WARN  SNMP TRAP 3: link up
11 Thu Jan  1 00:00:04 1970 PP05 -WARN  SNMP TRAP 3: link up
Clear Error Log (y/n):
```

Note: If you clear a log (by entering `y` at the `Clear Error Log (y/n) :` prompt), you cannot view it again.

32.2.4 show interface

Syntax:

```
show interface [port-number]
```

This command displays statistics of a port. The following example shows that port 2 is up and the related information.

Figure 117 show interface Command Example

```

ras# show interface 2
  Port Info      Port NO.      :2
                Link          :100M/F
                Status       :FORWARDING
                LACP         :Disabled
                TxPkts       :0
                RxPkts       :63
                Errors       :0
                Tx KBs/s     :0.0
                Rx KBs/s     :0.0
                Up Time      :0:02:33
TX Packet      Tx Packets    :0
                Multicast    :0
                Broadcast    :0
                Pause        :0
                Tagged       :0
RX Packet      Rx Packets    :63
                Multicast    :0
                Broadcast    :63
                Pause        :0
                Control      :0
TX Collison    Single         :0
                Multiple     :0
                Excessive    :0
                Late         :0
Error Packet   RX CRC         :0
                Length       :0
                Runt         :0
Distribution   64           :3
                65 to 127    :44
                128 to 255   :14
                256 to 511   :2
                512 to 1023  :0
                1024 to 1518 :0
                Giant        :0
ras#

```

32.2.5 show mac address-table

Syntax:

```
show mac address-table <all <sort>|static>
```

Where

<sort> = Specifies the sorting criteria (MAC, VID or port).

This command displays the MAC address(es) stored in the switch. The following example shows the static MAC address table.

Figure 118 show mac address-table Command Example

```
ras# show mac address-table static
Port      VLAN ID      MAC Address      Type
CPU       1            00:a0:c5:01:23:46  Static
ras#
```

32.3 ping

Syntax:

```
ping <ip|host-name> < [in-band|out-of-band|vlan <vlan-id> ] [
size <0-1472> ] [ -t ]>
```

where

<ip host-name>	=	The IP address or host name of an Ethernet device.
[in-band out-of-band vlan <vlan-id>]	=	Specifies the network interface or the VLAN ID to which the Ethernet device belongs.
		out-of-band refers the management port while in-band means the other ports on the switch.
[size <0-1472>]	=	Specifies the packet size to send.
[-t]	=	Sends Ping packets to the Ethernet device indefinitely. Click [CTRL]+ C to terminate the Ping process.

This command sends Ping packets to an Ethernet device. The following example sends Ping requests to and displays the replies from an Ethernet device with an IP address of 192.168.1.100.

Figure 119 ping Command Example

```

ras# ping 192.168.1.100
  sent  rcvd  rate    rtt     avg     mdev     max     min  reply from
    1     1   100      0      0       0       0       0    192.168.1.100
    2     2   100      0      0       0       0       0    192.168.1.100
    3     3   100      0      0       0       0       0    192.168.1.100
ras#

```

32.4 traceroute

Syntax:

```

traceroute <ip|host-name> [in-band|out-of-band|vlan <vlan-
id>][ttl <1-255>] [wait <1-60>] [queries <1-10>]

```

where

<ip|host-name> = The IP address or host name of an Ethernet device.

[in-band|out-of-band|vlan <vlan-id>] = Specifies the network interface or the VLAN ID to which the Ethernet device belongs.

[ttl <1-255>] = Specifies the Time To Live (TTL) period.

[wait <1-60>] = Specifies the time period to wait.

[quesries <1-10>] = Specifies how many tries the switch performs the traceroute function.

This command displays information about the route to an Ethernet device. The following example displays route information to an Ethernet device with an IP address of 192.168.1.100.

Figure 120 traceroute Command Example

```

ras> traceroute 192.168.1.100
traceroute to 192.168.1.100, 30 hops max, 40 byte packet
 1:192.168.1.100 (10 ms) (10 ms) (0 ms)
traceroute done:
ras>

```

32.5 Enabling RSTP

To enable RSTP on a port. Enter `spanning-tree` followed by the port number and press [ENTER].

An example is shown next.

- Enable RSTP on the switch.
- Enable RSTP on port 10.

Figure 121 Enable RSTP Command Example

```
ras(config)# spanning-tree
ras(config)# spanning-tree 10
```

32.6 Configuration File Maintenance

The following sections shows how to manage the configuration files.

32.6.1 Using a Different Configuration File

You can store up to two configuration files on the switch. Only one configuration file is used at a time. By default the switch uses the first configuration file (with an index number of 1). You can set the switch to use a different configuration file. There are two ways in which you can set the switch to use a different configuration file: restart the switch (cold reboot) and restart the system (warm reboot).

Use the `boot config` command to restart the switch and use a different configuration file (if specified). The following example restarts the switch to use the second configuration file.

Figure 122 CLI: boot config Command Example

```
ras# boot config 2
```

Use the `reload config` command to restart the system and use a different configuration file (if specified). The following example restarts the system to use the second configuration file.

Figure 123 CLI: reload config Command Example

```
ras# reload config 2
```

Note: When you use the `write memory` command without specifying a configuration file index number, the switch saves the changes to the configuration file the switch is currently using.

32.6.2 Resetting to the Factory Default

Follow the steps below to reset the switch back to the factory defaults.

- 1 Enter `erase running config` to reset the current running configuration.

- 2 Enter `write memory` to save the changes to the current configuration file. If you want to reset the second configuration file, use the `write memory` command again with the specified index number.

The following example resets both configuration files to the factory default settings.

Figure 124 CLI: Reset to the Factory Default Example

```
ras# erase running-config
ras# write memory
ras# write memory 2
```

32.7 no Command Examples

These are the commonly used command examples that belong to the `no` group of commands.

32.7.1 no mirror-port

Syntax:

```
no mirror-port
```

Disables port mirroring on the switch.

An example is shown next.

Figure 125 no mirror-port Command Example

```
ras(config)# no mirror-port
```

32.7.2 no https timeout

Syntax:

```
no https timeout
```

Resets the https session timeout to default.

An example is shown next. The session timeout is reset to 300 seconds.

Figure 126 no https timeout Command Example

```
ras(config)# no https timeout
Cache timeout 300
```

32.7.3 no trunk

Syntax:

```
no trunk <T1|T2|T3|T4|T5|T6>
no trunk <T1|T2|T3|T4|T5|T6> lacp
no trunk <T1|T2|T3|T4|T5|T6> interface <port-list>
```

where

<T1 T2 T3 T4 T5 T6>	Disables the trunk group.
<T1 T2 T3 T4 T5 T6> lacp	Disables LACP in the trunk group.
<T1 T2 T3 T4 T5 T6> interface <port-list>	Removes ports from the trunk group.

An example is shown next.

- Disable trunk one (T1).
- Disable LAPC on trunk three (T3).
- Remove ports one, three, four and five from trunk two (T2).

Figure 127 no trunk Command Example

```
ras(config)# no trunk T1
ras(config)# no trunk T3 lacp
ras(config)# no trunk T2 interface 1,3-5
```

32.7.4 no port-access-authenticator

Syntax:

```
no port-access-authenticator
no port-access-authenticator <port-list> reauthenticate
no port-access-authenticator <port-list>
```

where

= Disables port authentication on the switch.

`<port-list>` = Disables the re-authentication mechanism on the listed port(s).
`reauthenticate`

`<port-list>` = Disables authentication on the listed ports.

An example is shown next.

- Disable authentication on the switch.
- Disable re-authentication on ports one, three, four and five.
- Disable authentication on ports one, six and seven.

Figure 128 no port-access-authenticator Command Example

```

ras(config)# no port-access-authenticator
ras(config)# no port-access-authenticator 1,3-5 reauthenticate
ras(config)# no port-access-authenticator 1,6-7

```

32.7.5 no ssh

Syntax:

```

no ssh key <rsa1|rsa|dsa>
no ssh known-hosts <host-ip>
no ssh known-hosts <host-ip> [1024|ssh-rsa|ssh-dsa]

```

where

<code>key <rsa1 rsa dsa></code>	Disables the secure shell server encryption key. Your switch supports SSH versions 1 and 2 using RSA and DSA authentication.
<code>known-hosts <host-ip></code>	Remove specific remote hosts from the list of all known hosts.
<code>known-hosts <host-ip></code> <code>[1024 ssh-rsa ssh-dsa]</code>	Remove remote known hosts with a specified public key (1024-bit RSA1, RSA or DSA).

An example is shown next.

- Disable the secure shell RSA1 encryption key.
- Remove the remote host with IP address 172.165.1.8 from the list of known hosts.
- Remove the remote host with IP address 172.165.1.9 and with an SSH-RSA encryption key from the list of known hosts.

Figure 129 no ssh Command Example

```
ras(config)# no ssh key rsa1
ras(config)# no ssh known-hosts 172.165.1.8
ras(config)# no ssh known-hosts 172.165.1.9 ssh-rsa
```

32.8 interface Commands

These are some commonly used commands that belong to the `interface` group of commands.

32.8.1 interface port-channel

Syntax:

```
interface port-channel <port-list>
```

Use this command to enable the specified ports for configuration. Type multiple ports or port ranges separated by a comma. Ranges of port numbers are typed separated by a dash.

An example is shown next.

- Enter the configuration mode.
- Enable ports one, three, four and five for configuration.
- Begin configuring for those ports.

Figure 130 interface Command Example

```
ras# config
ras(config)# interface port-channel 1,3-5
ras(config-interface)#
```

32.8.2 bpdu-control

Syntax:

```
bpdu-control <peer|tunnel|discard|network>
```

where

`peer|tunnel|discard|network` > = Type `peer` to process any BPDUs received on these ports.

Type `tunnel` to forward BPDUs received on these ports.

Type `discard` to drop any BPDUs received on these ports.

Type `network` to process a BPDU with no VLAN tag and forward a tagged BPDU.

An example is shown next.

- Enable ports one, three, four and five for configuration.
- Set the BPDU control to `tunnel`, to forward BPDUs received on ports one, three, four and five.

Figure 131 interface bpdu-control Command Example

```

ras(config)# interface port-channel 1,3-5
ras(config-interface)# bpdu-control tunnel
ras(config-interface)#

```

32.8.3 broadcast-limit

Syntax:

```

broadcast-limit
broadcast-limit <pkt/s>

```

where

Enables broadcast storm control limit on the switch.

<pkt/s> Limits broadcast packet traffic the interface receives per second.

An example is shown next.

- Enable port one for configuration.
- Enable broadcast control.
- Set the broadband packet traffic the interface receives per second.

Figure 132 broadcast-limit Command Example

```
ras(config)# interface port-channel 1
ras(config-interface)# broadcast-limit
ras(config-interface)# broadcast-limit 21
```

32.8.4 bandwidth-limit

Syntax:

```
bandwidth-limit
bandwidth-limit pir <Kbps>
bandwidth-limit cir <Kbps>
bandwidth-limit egress <Kbps>
```

where

Enables bandwidth control on the switch.

<Kbps> Sets the maximum bandwidth allowed for outgoing traffic (egress) or incoming traffic (ingress) on the switch.

An example is shown next.

- Enable port one for configuration.
- Enable bandwidth control.
- Set the outgoing traffic bandwidth limit to 5000Kbps.
- Set the guaranteed bandwidth allowed for incoming traffic to 4000Kbps.
- Set the maximum bandwidth allowed for incoming traffic to 8000Kbps.

Figure 133 bandwidth-limit Command Example

```
ras(config)# interface port-channel 1
ras(config-interface)# bandwidth-limit
ras(config-interface)# bandwidth-limit egress 5000
ras(config-interface)# bandwidth-limit cir 4000
ras(config-interface)# bandwidth-limit pir 8000
```

32.8.5 mirror

Syntax:

```
mirror
mirror dir <ingress|egress|both>
```

where

Enables port mirroring on the interface.

<ingress|egress|both> = Enables port mirroring for incoming, outgoing or both incoming and outgoing traffic.

Port mirroring copies traffic from one or all ports to another or all ports for external analysis.

An example is shown next.

- Enable port mirroring.
- Enable the monitor port three.
- Enable ports one, four, five and six for configuration.
- Enable port mirroring on the ports.
- Enable port mirroring for outgoing traffic. Traffic is copied from ports one, four, five and six to port three in order to examine it in more detail without interfering with the traffic flow on the original port(s).

Figure 134 mirror Command Example

```

ras(config)# mirror-port
ras(config)# mirror-port 3
ras(config)# interface port-channel 1,4-6
ras(config-interface)# mirror
ras(config-interface)# mirror dir egress

```

32.8.6 gvrp

Syntax:

```
gvrp
```

GVRP (GARP VLAN Registration Protocol) is a registration protocol that defines a way for switches to register necessary VLAN members on ports across the network. Enable this function to permit VLANs groups beyond the local switch.

An example is shown next.

- Enable the IEEE 802.1Q tagged VLAN command to configure tagged VLAN for the switch.
- Enable ports one, three, four and five for configuration.
- Enable GVRP on the interface.

Figure 135 gvrp Command Example

```
ras(config)# vlan1q gvrp
ras(config)# interface port-channel 1,3-5
ras(config-interface)# gvrp
```

32.8.7 ingress-check

Syntax:

```
ingress-check
```

Enables the device to discard incoming frames for VLANs that are not included in a port member set.

An example is shown next.

- Enable ports one, three, four and five for configuration.
- Enable ingress checking on the interface.

Figure 136 ingress-check Command Example

```
ras(config)# interface port-channel 1,3-5
ras(config-interface)# ingress-check
```

32.8.8 frame-type

Syntax:

```
frame-type <all|tagged>
```

where

<all|tagged> Choose to accept both tagged and untagged incoming frames or just tagged incoming frames on a port.

An example is shown next.

- Enable ports one, three, four and five for configuration.
- Enable ingress checking on the ports.
- Enable tagged frame-types on the interface.

Figure 137 frame-type Command Example

```

ras(config)# interface port-channel 1,3-5
ras(config-interface)# ingress-check
ras(config-interface)# frame-type tagged

```

32.8.9 weight

Syntax:

```
weight <wt1> <wt2> ... <wt8>
```

where

<wt1> <wt2> ... <wt8> Sets the interface WFQ weighting. A weight value of one to eight is given to each variable from wt 1 to wt 8.

An example is shown next.

- Enable WFQ queuing on the switch.
- Enable port two and ports six to twelve for configuration.
- Set the queue weights from Q0 to Q7.

Figure 138 weight Command Example

```

ras# configure
ras(config)# wfq
ras(config)# interface port-channel 2,6-12
ras(config-interface)# weight 8 7 6 5 4 3 2 1

```

32.8.10 egress set

Syntax:

```
egress set <port-list>
```

where

<port-list> Sets the outgoing traffic port list for a port-based VLAN.

An example is shown next.

- Enable port-based VLAN tagging on the switch.
- Enable ports one, three, four and five for configuration.
- Set the outgoing traffic ports as the CPU (0), seven (7), eight (8) and nine (9).

Figure 139 egress set Command Example

```
ras(config)# vlan-type port-based
ras(config)# interface port-channel 1,3-5
ras(config-interface)# egress set 0,7-9
```

32.8.11 qos priority

Syntax:

```
qos priority <0 .. 7>
```

where

<0 .. 7> Sets the quality of service priority for a port.

An example is shown next.

- Enable ports one, three, four and five for configuration.
- Set the IEEE 802.1p quality of service priority as four (4).

Figure 140 qos priority Command Example

```
ras(config)# interface port-channel 1,3-5
ras(config-interface)# qos priority 4
```

32.8.12 name

Syntax:

```
name <port-name-string>
```

where

<port-name-string> Sets a name for your port interface(s).

An example is shown next.

- Enable ports one, three, four and five for configuration.
- Set a name for the ports.

Figure 141 name Command Example

```
ras(config)# interface port-channel 1,3-5
ras(config-interface)# name Test
```

32.8.13 speed-duplex

Syntax:

```
speed-duplex <auto|10-half|10-full|100-half|100-full|1000-full>
```

where

<pre><auto 10-half 10- full 100-half 100- full 1000-full></pre>	Sets the duplex mode (half or full) and speed (10, 100 or 1000 Mbps) of the connection on the port. Selecting auto (auto-negotiation) makes one port able to negotiate with a peer automatically to obtain the connection speed and duplex mode that both ends support.
---	---

An example is shown next.

- Enable ports one, three, four and five for configuration.
- Set the speed to 100 Mbps in half duplex mode.

Figure 142 speed-duplex Command Example

```
ras(config)# interface port-channel 1,3-5
ras(config-interface)# speed-duplex 100-half
```

CHAPTER 33

IEEE 802.1Q Tagged VLAN Commands

This chapter describes the IEEE 802.1Q Tagged VLAN and associated commands.

33.1 IEEE 802.1Q Tagged VLAN Overview

See the VLAN chapter for more information on VLANs. There are two kinds of tagging:

1 Explicit Tagging

A VLAN identifier is added to the frame header that identifies the source VLAN.

2 Implicit Tagging

The MAC (Media Access Control) number, the port or other information is used to identify the source of a VLAN frame.

The IEEE 802.1Q Tagged VLAN uses both explicit and implicit tagging.

Whether to tag an outgoing frame depends on the setting of the egress port on a per-LAN, per-port basis (recall that a port can belong to multiple VLANs). If the tagging on the egress port is enabled for the VID of a frame, then the frame is transmitted as a tagged frame; otherwise, it is transmitted as an untagged frame.

33.2 VLAN Databases

A VLAN database stores and organizes VLAN registration information useful for switching frames to and from a switch. A VLAN database consists of a static entries (Static VLAN or SVLAN table) and dynamic entries (Dynamic VLAN or DVLAN table).

33.2.1 Static Entries (SVLAN Table)

Static entry registration information is added, modified and removed by administrators only.

33.2.2 Dynamic Entries (DVLAN Table)

Dynamic entries are learned by the switch and cannot be created or updated by administrators. The switch learns this information by observing what port, source address and VLAN ID (or VID) is associated with a frame. Entries are added and deleted using GARP VLAN Registration Protocol (GVRP), where GARP is the Generic Attribute Registration Protocol.

33.3 Configuring Tagged VLAN

The following procedure shows you how to configure tagged VLAN.

- 1 Use the IEEE 802.1Q tagged VLAN commands to configure tagged VLAN for the switch.
 - Use the `vlan <vlan-id>` command to configure or create a VLAN on the switch. The switch automatically enters the `config-vlan` mode. Use the `inactive` command to deactivate the VLAN(s).
 - Use the `interface port-channel <port-list>` command to enter the `config-interface` mode to set the VLAN settings on a port, then use the `pvid <vlan-id>` command to set the VLAN ID you created for the `port-list` to that specific port in the PVID table.
 - Use the `exit` command when you are finished configuring the VLAN.

Example:

Figure 143 Tagged VLAN Configuration and Activation Example

```
ras (config)# vlan 2000
ras (config-vlan)# name up1
ras (config-vlan)# fixed 10-12
ras (config-vlan)# no untagged 10-12
ras (config-vlan)# exit
ras (config)# interface port-channel 10-12
ras (config-interface)# pvid 2000
ras (config-interface)# exit
```

- 2 Configure your management VLAN.
 - Use the `vlan <vlan-id>` command to create a VLAN (VID 3 in this example) for managing the switch, and the switch will activate the new management VLAN.
 - Use the `inactive` command to disable the new management VLAN.

Example:

Figure 144 CPU VLAN Configuration and Activation Example

```

ras (config)# vlan 3
ras (config-vlan)# inactive

```

33.4 Global VLAN1Q Tagged VLAN Configuration Commands

This section shows you how to configure and monitor the IEEE 802.1Q Tagged VLAN.

33.4.1 GARP Status

Syntax:

```
show garp
```

This command shows the switch's GARP timer settings, including the join, leave and leave all timers.

An example is shown next.

Figure 145 GARP STATUS Command Example

```

ras # show garp
GARP Timer
-----
Join Timer = 200
Leave Timer = 600
Leave All Timer = 10000
ras#

```

33.4.2 GARP Timer

Syntax:

```
garp join <msec> leave <msec> leaveall <msec>
```

where

`join <msec>` = This sets the duration of the Join Period timer for GVRP in milliseconds. Each port has a Join Period timer. The allowed Join Time range is between 100 and 32767 milliseconds; the default is 200 milliseconds.

- `leave <msec>` = This sets the duration of the Leave Period timer for GVRP in milliseconds. Each port has a single Leave Period timer. Leave Time must be two times larger than Join Timer; the default is 600 milliseconds.
- `leaveall <msec>` = This sets the duration of the Leave All Period timer for GVRP in milliseconds. Each port has a single Leave All Period timer. Leave All Timer must be larger than Leave Timer; the default is 10000 milliseconds.

This command sets the switch's GARP timer settings, including the join, leave and leave all timers.

Switches join VLANs by making a declaration. A declaration is made by issuing a Join message using GARP. Declarations are withdrawn by issuing a Leave message. A Leave All message terminates all registrations. GARP timers set declaration timeout values.

The following example sets the Join Timer to 300 milliseconds, the Leave Timer to 800 milliseconds and the Leave All Timer to 11000 milliseconds.

Figure 146 GARP Timer Command Example

```
ras (config)# garp join 300 leave 800 leaveall 11000
```

33.4.3 GVRP Timer

Syntax:

```
show vlan1q gvrp
```

This command shows the switch's GVRP settings.

An example is shown next.

Figure 147 GVRP Status Command Example

```
ras # show vlan1q gvrp
GVRP Support
-----
gvrpEnable = YES
ras #
```

33.4.4 Enable GVRP

Syntax:

```
vlan1q gvrp
```

This command turns on GVRP in order to propagate VLAN information beyond the switch.

33.4.5 Disable GVRP

Syntax:

```
no vlan1q gvrp
```

This command turns off GVRP so that the switch does not propagate VLAN information to other switches.

33.5 Port VLAN Commands

You must configure the switch port VLAN settings in config-interface mode.

33.5.1 Set Port VID

Syntax:

```
pvid <VID>
```

where

<VID> = Specifies the VLAN number between 1 and 4094

This command sets the default VLAN ID on the port(s).

The following example sets the default VID to 200 on ports 1 to 5.

Figure 148 vlan1q port default vid Command Example

```
ras (config)# interface port-channel 1-5
ras (config-interface)# pvid 200
```

33.5.2 Set Acceptable Frame Type

Syntax:

```
frame-type <all|tagged>
```

where

<all|tagged> = Specifies all Ethernet frames (tagged and untagged) or only tagged Ethernet frames.

This command sets the specified port to accept all Ethernet frames or only those with an IEEE 802.1Q VLAN tag.

The following example sets ports 1 to 5 to accept only tagged frames.

Figure 149 frame type Command Example

```
ras (config)# interface port-channel 1-5
ras (config-interface)# frame-type tagged
```

33.5.3 Enable or Disable Port GVRP

Use the `gvrp` command to enable GVRP on the port(s). Use the `no gvrp` command to disable GVRP.

The following example turns off GVRP for ports 1 to 5.

Figure 150 no gvrp Command Example

```
ras (config)# interface port-channel 1-5
ras (config-interface)# no gvrp
```

33.5.4 Modify Static VLAN

Use the following commands in the `config-vlan` mode to configure the static VLAN table.

Syntax:

```
vlan <vlan-id>
fixed <port-list>
forbidden <port-list>
name <name-str>
normal <port-list>
untagged <port-list>
no fixed <port-list>
no forbidden <port-list>
no untagged <port-list>
```

where

<vlan-id> = The VLAN ID [1 – 4094].
<name-str> = A name to identify the SVLAN entry.
<port-list> = This is the switch port list.

- Enter `fixed` to register the <port-list> to the static VLAN table with <vlan-id>.
- Enter `normal` to confirm registration of the <port-list> to the static VLAN table with <vlan-id>.

- Enter `forbidden` to block a `<port-list>` from joining the static VLAN table with `<vlan-id>`.
- Enter `no fixed` or `no forbidden to change` `<port-list>` to normal status.
- Enter `untagged` to send outgoing frames without a tag.
- Enter `no untagged` to tag outgoing frames.

33.5.4.1 Modify a Static VLAN Table Example

The following example configures ports 1 to 5 as fixed and untagged ports in VLAN 2000.

Figure 151 Modifying Static VLAN Example

```

ras (config)# vlan 2000
ras (config-vlan)# fixed 1-5
ras (config-vlan)# untagged 1-5

```

33.5.4.2 Forwarding Process Example

33.5.4.2.1 Tagged Frames

- 1 First the switch checks the VLAN ID (VID) of tagged frames or assigns temporary VIDs to untagged frames.
- 2 The switch then checks the VID in a frame's tag against the SVLAN table.
- 3 The switch notes what the SVLAN table says (that is, the SVLAN tells the switch whether or not to forward a frame and if the forwarded frames should have tags).
- 4 Then the switch applies the port filter to finish the forwarding decision. This means that frames may be dropped even if the SVLAN says to forward them. Frames might also be dropped if they are sent to a CPE (customer premises equipment) DSL device that does not accept tagged frames.

33.5.4.2.2 Untagged Frames

- 1 An untagged frame comes in from the LAN.
- 2 The switch checks the PVID table and assigns a temporary VID of 1.
- 3 The switch ignores the port from which the frame came, because the switch does not send a frame to the port from which it came. The switch also does not forward frames to "forbidden" ports.
- 4 If after looking at the SVLAN, the switch does not have any ports to which it will send the frame, it won't check the port filter.

33.5.5 Delete VLAN ID

Syntax:

```
no vlan <vlan-id>
```

where

<vlan-id> = The VLAN ID [1 – 4094].

This command deletes the specified VLAN ID entry from the static VLAN table. The following example deletes entry 2 in the static VLAN table.

Figure 152 no vlan Command Example

```
ras (config)# no vlan 2
```

33.6 Enable VLAN

Syntax:

```
vlan <vlan-id>
```

This command enables the specified VLAN ID in the SVLAN (Static VLAN) table.

33.7 Disable VLAN

Syntax:

```
vlan <vlan-id> inactive
```

This command disables the specified VLAN ID in the SVLAN (Static VLAN) table.

33.8 Show VLAN Setting

Syntax:

```
show vlan
```

This command shows the IEEE 802.1Q Tagged SVLAN (Static VLAN) table.

An example is shown next.

- For the `AdCtl` section of the last column, “-“ is a port set to normal, “x” is a forbidden port and “F” is a fixed port.
- For the `TagCtl` section of the last column, “T” is a tagged port, “U” is an untagged port.

Figure 153 show vlan Command Example

```
ras# show vlan
802.1Q VLAN Static Entry:
idx. Name          VID  Active  AdCtl / TagCtl
-----
  0             1    1 active  FFFFFFFFFFFFFFFFFF
                1    1 active  UUUUUUUUUUUUUUUUU
  2             test2  2 active  FFXFXFXFXFXFXFXFX
                2    2 active  UUUUUUUUUUUUUUUUU
ras#
```

CHAPTER 34

Troubleshooting

This chapter covers potential problems and possible remedies.

34.1 Problems Starting Up the Switch

Table 73 Troubleshooting the Start-Up of Your Switch

PROBLEM	CORRECTIVE ACTION
None of the LEDs turn on when you turn on the switch.	Check the power connection and make sure the power source is turned on. If the error persists, you may have a hardware problem. In this case, you should contact your vendor.

34.2 Problems Accessing the Switch

Table 74 Troubleshooting Accessing the Switch

PROBLEM	CORRECTIVE ACTION
I cannot access the switch using Telnet.	Make sure the ports are properly connected. You may have exceeded the maximum number of concurrent Telnet sessions. Close other Telnet session(s) or try connecting again later. Check that you have enabled Telnet service access. If you have configured a secured client IP address, your computer's IP address must match it. Refer to the chapter on access control for details.

Table 74 Troubleshooting Accessing the Switch

PROBLEM	CORRECTIVE ACTION
I cannot access the web configurator.	<p>The administrator username is “admin”. The default administrator password is “1234”. The username and password are case-sensitive. Make sure that you enter the correct password and username using the proper casing. If you have changed the password and have now forgotten it, you will need to upload the default configuration file. This restores all of the factory defaults including the password.</p> <p>Check that you have enabled web service access. If you have configured a secured client IP address, your computer's IP address must match it. Refer to the chapter on access control for details.</p> <p>Your computer's and the switch's IP addresses must be on the same subnet.</p> <p>See the following section to check that pop-up windows, JavaScripts and Java permissions are allowed.</p> <hr/> <p>You may also need to clear your Internet browser's cache.</p> <p>In Internet Explorer, click Tools and then Internet Options to open the Internet Options screen.</p> <p>In the General tab, click Delete Files. In the pop-up window, select the Delete all offline content check box and click OK. Click OK in the Internet Options screen to close it.</p> <p>If you disconnect your computer from one device and connect it to another device that has the same IP address, your computer's ARP (Address Resolution Protocol) table may contain an entry that maps the management IP address to the previous device's MAC address).</p> <p>In Windows, use arp -d at the command prompt to delete all entries in your computer's ARP table.</p>

34.2.1 Pop-up Windows, JavaScripts and Java Permissions

In order to use the web configurator you need to allow:

- Web browser pop-up windows from your device.
- JavaScripts (enabled by default).
- Java permissions (enabled by default).

Note: Internet Explorer 6 screens are used here. Screens for other Internet Explorer versions may vary.

34.2.1.1 Internet Explorer Pop-up Blockers

You may have to disable pop-up blocking to log into your device.

Either disable pop-up blocking (enabled by default in Windows XP SP (Service Pack) 2) or allow pop-up blocking and create an exception for your device's IP address.

34.2.1.1.1 Disable pop-up Blockers

- 1 In Internet Explorer, select **Tools, Pop-up Blocker** and then select **Turn Off Pop-up Blocker**.

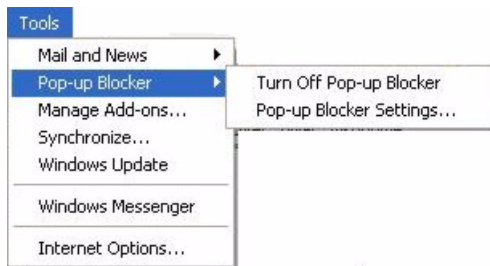
Figure 154 Pop-up Blocker

You can also check if pop-up blocking is disabled in the **Pop-up Blocker** section in the **Privacy** tab.

- 1 In Internet Explorer, select **Tools, Internet Options, Privacy**.
- 2 Clear the **Block pop-ups** check box in the **Pop-up Blocker** section of the screen. This disables any web pop-up blockers you may have enabled.

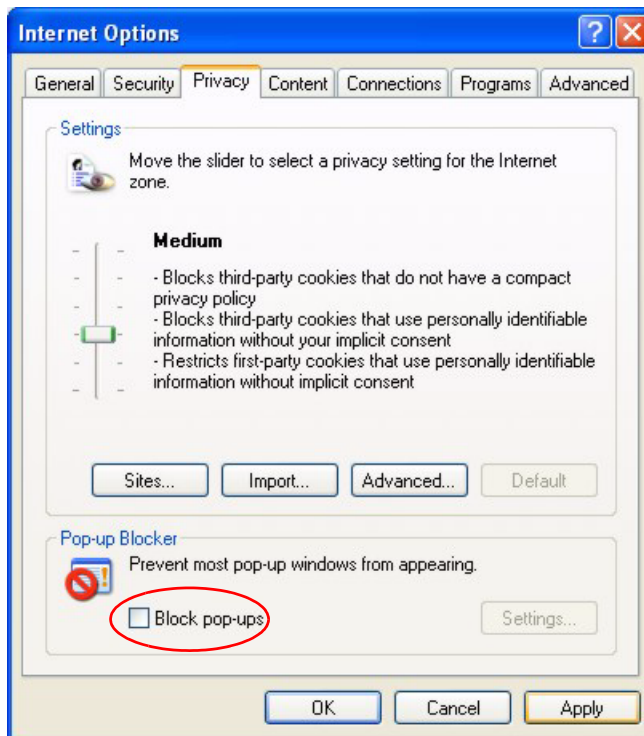
Figure 155 Internet Options

- 3 Click **Apply** to save this setting.

34.2.1.1.2 Enable pop-up Blockers with Exceptions

Alternatively, if you only want to allow pop-up windows from your device, see the following steps.

- 1 In Internet Explorer, select **Tools, Internet Options** and then the **Privacy** tab.
- 2 Select **Settings...** to open the **Pop-up Blocker Settings** screen.

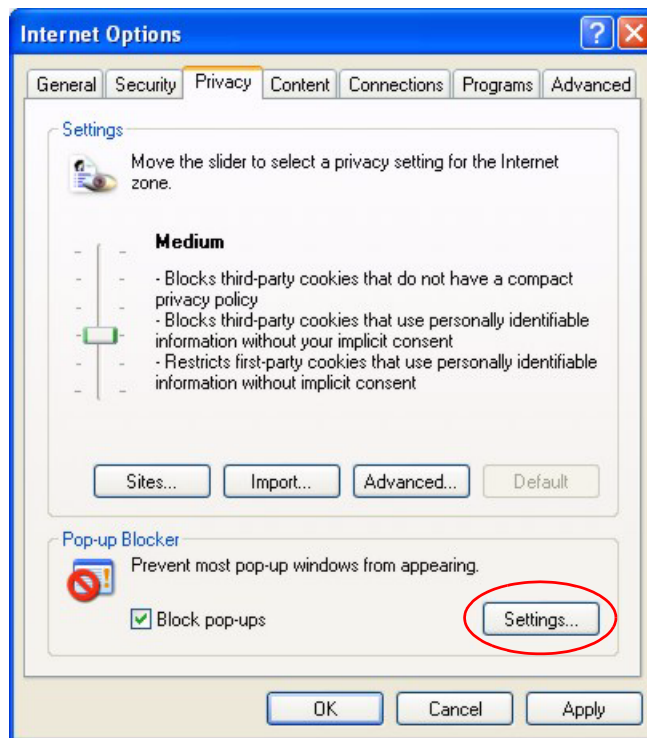
Figure 156 Internet Options

- 3** Type the IP address of your device (the web page that you do not want to have blocked) with the prefix “http://”. For example, http://192.168.1.1.
- 4** Click **Add** to move the IP address to the list of **Allowed sites**.

Figure 157 Pop-up Blocker Settings

5 Click **Close** to return to the **Privacy** screen.

6 Click **Apply** to save this setting.

34.2.1.2 JavaScripts

If pages of the web configurator do not display properly in Internet Explorer, check that JavaScripts are allowed.

1 In Internet Explorer, click **Tools, Internet Options** and then the **Security** tab.

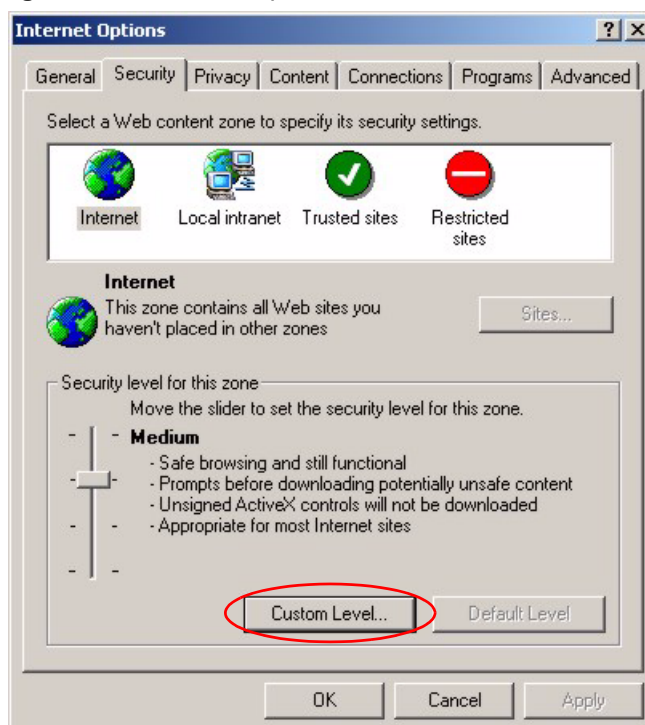
Figure 158 Internet Options

- 2** Click the **Custom Level...** button.
- 3** Scroll down to **Scripting**.
- 4** Under **Active scripting** make sure that **Enable** is selected (the default).
- 5** Under **Scripting of Java applets** make sure that **Enable** is selected (the default).
- 6** Click **OK** to close the window.

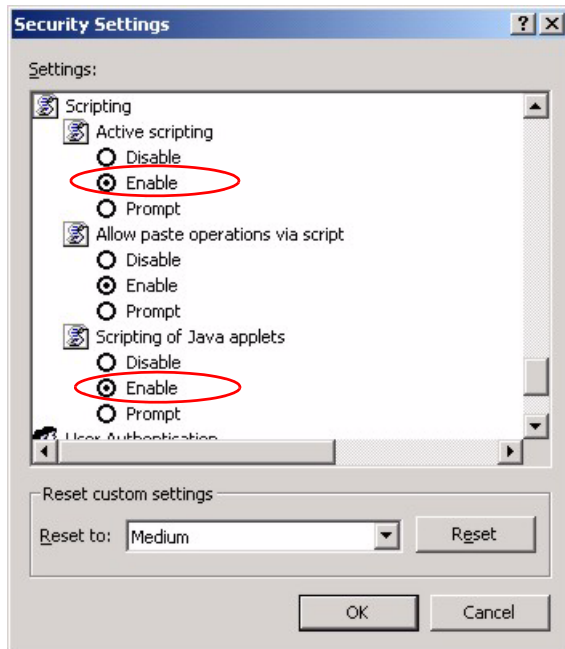
Figure 159 Security Settings - Java Scripting

34.2.1.3 Java Permissions

- 1 From Internet Explorer, click **Tools, Internet Options** and then the **Security** tab.
- 2 Click the **Custom Level...** button.
- 3 Scroll down to **Microsoft VM**.
- 4 Under **Java permissions** make sure that a safety level is selected.
- 5 Click **OK** to close the window.

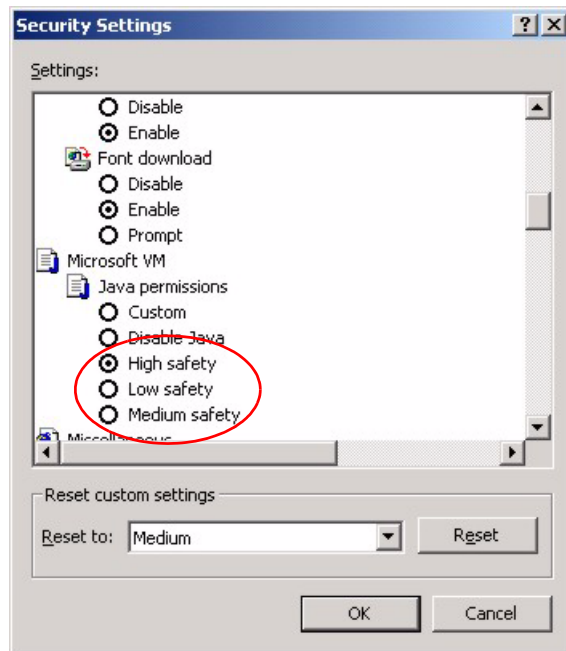
Figure 160 Security Settings - Java

34.2.1.3.1 JAVA (Sun)

- 1 From Internet Explorer, click **Tools, Internet Options** and then the **Advanced** tab.
- 2 make sure that **Use Java 2 for <applet>** under **Java (Sun)** is selected.
- 3 Click **OK** to close the window.

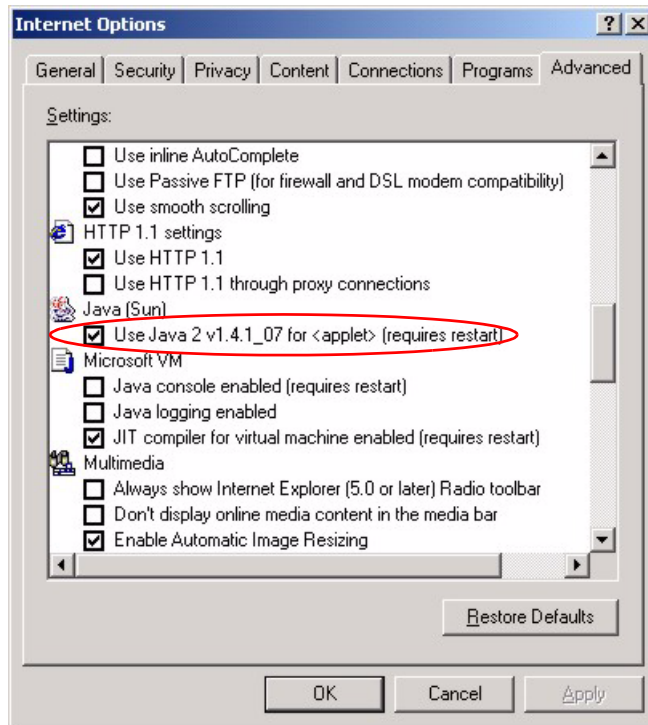
Figure 161 Java (Sun)

34.3 Problems with the Password

Table 75 Troubleshooting the Password

PROBLEM	CORRECTIVE ACTION
Cannot access the switch.	The password field is case sensitive. Make sure that you enter the correct password using the proper casing.
	The administrator username is "admin". The default administrator password is "1234". The username and password are case-sensitive. Make sure that you enter the correct password and username using the proper casing. If you have changed the password and have now forgotten it, you will need to upload the default configuration file. This restores all of the factory defaults including the password.

APPENDIX A

Product Specifications

These are the switch product specifications.

Table 76 General Product Specifications

Ethernet Interface	48 10/100 Base-TX interfaces Auto-negotiation Auto-MDI/MDIX Compliant with IEEE 802.3/3u Back pressure flow control for half duplex Flow control for full duplex (IEEE 802.3x) RJ-45 Ethernet cable connector
Gigabit Interface	Two Gigabit/mini-GBIC combo ports Two Gigabit ports
Bridging	16K MAC addresses Static MAC address filtering (port lock) Broadcast storm control Limited maximum number of MAC addresses per port
Switching	Switching fabric: 17.6Gbps, non-blocking Max. Frame size: 1522 bytes Forwarding frame: IEEE 802.3, IEEE 802.1q, Ethernet II, PPPoE Prevent the forwarding of corrupted packets
STP	IEEE 802.1d spanning tree protocol IEEE 802.1w, rapid reconfiguration to recover network failure
QoS	IEEE 802.1p Four priority queues Supports RFC 2475 DiffServ, DSCP to IEEE 802.1p priority mapping
Security	IEEE 802.1x port-based authentication Static MAC Address Forward
VLAN	Port-based VLAN setting Tag-based (IEEE 802.1Q) VLAN Number of VLAN: 4K (256 static VLANs) Supports GVRP
Link aggregation	Supports IEEE 802.3ad; static and dynamic (LACP) port trunking Up to six groups and each group can aggregate up to eight ports
Port mirroring	All ports support port mirroring
Bandwidth control	Supports rate limiting at 64Kbps increment

Table 77 Management Specifications

System Control	Alarm/Status surveillance LED indication for alarm and system status Performance monitoring Line speed Four RMON groups (history, statistics, alarms, and events) Throughput monitoring CMP packet transmission Port mirroring and aggregation Spanning Tree Protocol IGMP snooping Firmware upgrade and download through FTP/TFTP Login authorization and security levels (read only and read/write) Self diagnostics FLASH memory
Network Management	CLI through console port and telnet Web-based management Clustering: up to 24 switches can be manage by one IP SNMP RMON groups (history, statistics, alarms and events)
MIB	RFC1213 MIB II RFC1493 Bridge MIB RFC1643 Ethernet MIB RFC1757 Four groups of RMON RFC 1155 SMI RFC2674 Bridge MIB extension (for IEEE 802.1Q)

Table 78 Physical and Environmental Specifications

LEDs	Per switch: PWR, SYS, ALM, BPS Per Ethernet port: LNK/ACT, FDX/COL
Dimension	438 mm (W) x 300 mm (D) x 44.45 mm (H) Standard 19" rack mountable
Weight	4.2Kg
Temperature	Operating: 0° C ~ 45° C Storage: -10° C ~ 70° C
Humidity	10 ~ 90% (non-condensing)
Power Supply	Overload protection 100-240VAC, 50/60Hz, 1.5A Max.

Table 78 Physical and Environmental Specifications (continued)

Safety	ANS/UL 60950-1 CSA 60950-1 EN 60950-1 IEC 60950-1
EMC	FCC Part 15 (Class A) CE EMC (Class A)

APPENDIX B

IP Subnetting

IP Addressing

Routers “route” based on the network number. The router that delivers the data packet to the correct destination host uses the host ID.

IP Classes

An IP address is made up of four octets (eight bits), written in dotted decimal notation, for example, 192.168.1.1. IP addresses are categorized into different classes. The class of an address depends on the value of its first octet.

- Class “A” addresses have a 0 in the left most bit. In a class “A” address the first octet is the network number and the remaining three octets make up the host ID.
- Class “B” addresses have a 1 in the left most bit and a 0 in the next left most bit. In a class “B” address the first two octets make up the network number and the two remaining octets make up the host ID.
- Class “C” addresses begin (starting from the left) with 1 1 0. In a class “C” address the first three octets make up the network number and the last octet is the host ID.
- Class “D” addresses begin with 1 1 1 0. Class “D” addresses are used for multicasting. (There is also a class “E” address. It is reserved for future use.)

Table 79 Classes of IP Addresses

IP ADDRESS:		OCTET 1	OCTET 2	OCTET 3	OCTET 4
Class A	0	Network number	Host ID	Host ID	Host ID
Class B	10	Network number	Network number	Host ID	Host ID
Class C	110	Network number	Network number	Network number	Host ID

Note: Host IDs of all zeros or all ones are not allowed.

Therefore:

A class “C” network (8 host bits) can have $2^8 - 2$ or 254 hosts.

A class “B” address (16 host bits) can have $2^{16} - 2$ or 65534 hosts.

A class “A” address (24 host bits) can have $2^{24} - 2$ hosts (approximately 16 million hosts).

Since the first octet of a class “A” IP address must contain a “0”, the first octet of a class “A” address can have a value of 0 to 127.

Similarly the first octet of a class “B” must begin with “10”, therefore the first octet of a class “B” address has a valid range of 128 to 191. The first octet of a class “C” address begins with “110”, and therefore has a range of 192 to 223.

Table 80 Allowed IP Address Range By Class

CLASS	ALLOWED RANGE OF FIRST OCTET (BINARY)	ALLOWED RANGE OF FIRST OCTET (DECIMAL)
Class A	00000000 to 01111111	0 to 127
Class B	10000000 to 10111111	128 to 191
Class C	11000000 to 11011111	192 to 223
Class D	11100000 to 11101111	224 to 239

Subnet Masks

A subnet mask is used to determine which bits are part of the network number, and which bits are part of the host ID (using a logical AND operation). A subnet mask has 32 is a “1” then the corresponding bit in the IP address is part of the network number. If a bit in the subnet mask is “0” then the corresponding bit in the IP address is part of the host ID.

Subnet masks are expressed in dotted decimal notation just as IP addresses are. The “natural” masks for class A, B and C IP addresses are as follows.

Table 81 “Natural” Masks

CLASS	NATURAL MASK
A	255.0.0.0
B	255.255.0.0
C	255.255.255.0

Subnetting

With subnetting, the class arrangement of an IP address is ignored. For example, a class C address no longer has to have 24 bits of network number and 8 bits of host ID. With subnetting, some of the host ID bits are converted into network number bits. By convention, subnet masks always consist of a continuous sequence of ones beginning from the left most bit of the mask, followed by a continuous sequence of zeros, for a total number of 32 bits.

Since the mask is always a continuous number of ones beginning from the left, followed by a continuous number of zeros for the remainder of the 32 bit mask, you can simply specify the number of ones instead of writing the value of each octet. This is usually specified by writing a “/” followed by the number of bits in the mask after the address.

For example, 192.1.1.0 /25 is equivalent to saying 192.1.1.0 with mask 255.255.255.128.

The following table shows all possible subnet masks for a class “C” address using both notations.

Table 82 Alternative Subnet Mask Notation

SUBNET MASK IP ADDRESS	SUBNET MASK “1” BITS	LAST OCTET BIT VALUE
255.255.255.0	/24	0000 0000
255.255.255.128	/25	1000 0000
255.255.255.192	/26	1100 0000
255.255.255.224	/27	1110 0000
255.255.255.240	/28	1111 0000
255.255.255.248	/29	1111 1000
255.255.255.252	/30	1111 1100

The first mask shown is the class “C” natural mask. Normally if no mask is specified it is understood that the natural mask is being used.

Example: Two Subnets

As an example, you have a class “C” address 192.168.1.0 with subnet mask of 255.255.255.0.

Table 83 Two Subnets Example

	NETWORK NUMBER	HOST ID
IP Address	192.168.1.	0
IP Address (Binary)	11000000.10101000.00000001.	00000000
Subnet Mask	255.255.255.	0
Subnet Mask (Binary)	11111111.11111111.11111111.	00000000

The first three octets of the address make up the network number (class “C”). You want to have two separate networks.

Divide the network 192.168.1.0 into two separate subnets by converting one of the host ID bits of the IP address to a network number bit. The “borrowed” host ID bit can be either “0” or “1” thus giving two subnets; 192.168.1.0 with mask 255.255.255.128 and 192.168.1.128 with mask 255.255.255.128.

Note: In the following charts, shaded/bolded last octet bit values indicate host ID bits “borrowed” to form network ID bits. The number of “borrowed” host ID bits determines the number of subnets you can have. The remaining number of host ID bits (after “borrowing”) determines the number of hosts you can have on each subnet.

Table 84 Subnet 1

	NETWORK NUMBER	LAST OCTET BIT VALUE
IP Address	192.168.1.	0
IP Address (Binary)	11000000.10101000.00000001.	00000000
Subnet Mask	255.255.255.	128
Subnet Mask (Binary)	11111111.11111111.11111111.	10000000
Subnet Address: 192.168.1.0	Lowest Host ID: 192.168.1.1	
Broadcast Address: 192.168.1.127	Highest Host ID: 192.168.1.126	

Table 85 Subnet 2

	NETWORK NUMBER	LAST OCTET BIT VALUE
IP Address	192.168.1.	128
IP Address (Binary)	11000000.10101000.00000001.	10000000
Subnet Mask	255.255.255.	128
Subnet Mask (Binary)	11111111.11111111.11111111.	10000000
Subnet Address: 192.168.1.128	Lowest Host ID: 192.168.1.129	
Broadcast Address: 192.168.1.255	Highest Host ID: 192.168.1.254	

The remaining 7 bits determine the number of hosts each subnet can have. Host IDs of all zeros represent the subnet itself and host IDs of all ones are the broadcast address for that subnet, so the actual number of hosts available on each subnet in the example above is $2^7 - 2$ or 126 hosts for each subnet.

192.168.1.0 with mask 255.255.255.128 is the subnet itself, and 192.168.1.127 with mask 255.255.255.128 is the directed broadcast address for the first subnet. Therefore, the lowest IP address that can be assigned to an actual host for the first subnet is 192.168.1.1 and the highest is 192.168.1.126. Similarly the host ID range for the second subnet is 192.168.1.129 to 192.168.1.254.

Example: Four Subnets

The above example illustrated using a 25-bit subnet mask to divide a class “C” address space into two subnets. Similarly to divide a class “C” address into four subnets, you need to “borrow” two host ID bits to give four possible combinations of 00, 01, 10 and 11. The subnet mask is 26 bits (11111111.11111111.11111111.11000000) or 255.255.255.192. Each subnet contains 6 host ID bits, giving 2^6-2 or 62 hosts for each subnet (all 0’s is the subnet itself, all 1’s is the broadcast address on the subnet).

Table 86 Subnet 1

	NETWORK NUMBER	LAST OCTET BIT VALUE
IP Address	192.168.1.	0
IP Address (Binary)	11000000.10101000.00000001.	00000000
Subnet Mask (Binary)	11111111.11111111.11111111.	11000000
Subnet Address: 192.168.1.0	Lowest Host ID: 192.168.1.1	
Broadcast Address: 192.168.1.63	Highest Host ID: 192.168.1.62	

Table 87 Subnet 2

	NETWORK NUMBER	LAST OCTET BIT VALUE
IP Address	192.168.1.	64
IP Address (Binary)	11000000.10101000.00000001.	01000000
Subnet Mask (Binary)	11111111.11111111.11111111.	11000000
Subnet Address: 192.168.1.64	Lowest Host ID: 192.168.1.65	
Broadcast Address: 192.168.1.127	Highest Host ID: 192.168.1.126	

Table 88 Subnet 3

	NETWORK NUMBER	LAST OCTET BIT VALUE
IP Address	192.168.1.	128
IP Address (Binary)	11000000.10101000.00000001.	10000000
Subnet Mask (Binary)	11111111.11111111.11111111.	11000000
Subnet Address: 192.168.1.128	Lowest Host ID: 192.168.1.129	
Broadcast Address: 192.168.1.191	Highest Host ID: 192.168.1.190	

Table 89 Subnet 4

	NETWORK NUMBER	LAST OCTET BIT VALUE
IP Address	192.168.1.	192
IP Address (Binary)	11000000.10101000.00000001.	11000000
Subnet Mask (Binary)	11111111.11111111.11111111.	11000000
Subnet Address: 192.168.1.192	Lowest Host ID: 192.168.1.193	
Broadcast Address: 192.168.1.255	Highest Host ID: 192.168.1.254	

Example Eight Subnets

Similarly use a 27-bit mask to create 8 subnets (001, 010, 011, 100, 101, 110).

The following table shows class C IP address last octet values for each subnet.

Table 90 Eight Subnets

SUBNET	SUBNET ADDRESS	FIRST ADDRESS	LAST ADDRESS	BROADCAST ADDRESS
1	0	1	30	31
2	32	33	62	63
3	64	65	94	95
4	96	97	126	127
5	128	129	158	159
6	160	161	190	191
7	192	193	222	223
8	224	225	254	255

The following table is a summary for class “C” subnet planning.

Table 91 Class C Subnet Planning

NO. “BORROWED” HOST BITS	SUBNET MASK	NO. SUBNETS	NO. HOSTS PER SUBNET
1	255.255.255.128 (/25)	2	126
2	255.255.255.192 (/26)	4	62
3	255.255.255.224 (/27)	8	30
4	255.255.255.240 (/28)	16	14
5	255.255.255.248 (/29)	32	6
6	255.255.255.252 (/30)	64	2
7	255.255.255.254 (/31)	128	1

Subnetting With Class A and Class B Networks.

For class “A” and class “B” addresses the subnet mask also determines which bits are part of the network number and which are part of the host ID.

A class “B” address has two host ID octets available for subnetting and a class “A” address has three host ID octets (see [Table 79 on page 267](#)) available for subnetting.

The following table is a summary for class “B” subnet planning.

Table 92 Class B Subnet Planning

NO. “BORROWED” HOST BITS	SUBNET MASK	NO. SUBNETS	NO. HOSTS PER SUBNET
1	255.255.128.0 (/17)	2	32766
2	255.255.192.0 (/18)	4	16382
3	255.255.224.0 (/19)	8	8190
4	255.255.240.0 (/20)	16	4094
5	255.255.248.0 (/21)	32	2046
6	255.255.252.0 (/22)	64	1022
7	255.255.254.0 (/23)	128	510
8	255.255.255.0 (/24)	256	254
9	255.255.255.128 (/25)	512	126
10	255.255.255.192 (/26)	1024	62
11	255.255.255.224 (/27)	2048	30
12	255.255.255.240 (/28)	4096	14
13	255.255.255.248 (/29)	8192	6
14	255.255.255.252 (/30)	16384	2
15	255.255.255.254 (/31)	32768	1

Index

Symbols

“standby” ports [111](#)

Numerics

110V AC [3](#)
 230V AC [3](#)
 802.1P priority [76](#)

A

AC [3](#)
 Access control [185](#)
 Access priority [125](#)
 Limitation [125](#)
 Login account [128](#)
 Remote management [136](#)
 Service port [135](#)
 SNMP [126](#)
 Accessories [3](#)
 Address Resolution Protocol (ARP) [195](#)
 Administrator password [129](#)
 Aggregator ID [113](#)
 Aging time [70](#)
 Airflow [3](#)
 Alternative Subnet Mask Notation [269](#)
 American Wire Gauge [3](#)
 Application [31](#)
 Backbone [31](#)
 Bridging [32](#)
 IEEE 802.1Q VLAN [33](#)
 Switched workgroup [32](#)
 ARP [195](#)
 How it works [195](#)
 View [195](#)
 Authority [2](#)
 Automatic VLAN registration [78](#)
 AWG [3](#)

B

Basement [3](#)
 Basic setting [65](#)
 BPDUs (Bridge Protocol Data Units) [94](#)
 Bridge Protocol Data Units (BPDUs) [94](#)

C

Cables, Connecting [3](#)
 CFI (Canonical Format Indicator) [77](#)
 Change password [50](#)
 Changes or Modifications [2](#)
 CI Commands [199](#)
 CLI Command
 Configure tagged VLAN example [244](#)
 Static VLAN Table example [249](#)
 Cluster management [29](#), [187](#)
 Cluster manager [187](#), [191](#)
 Cluster member [187](#), [192](#)
 Cluster member firmware upgrade [189](#)
 Network example [187](#)
 Setup [190](#)
 Specification [187](#)
 Status [188](#)
 Switch models [187](#)
 VID [191](#)
 Web configurator [189](#)
 Cluster manager [187](#)
 Cluster member [187](#)
 Command
 Forwarding Process Example [249](#)
 Summary [203](#)
 Syntax conventions [199](#)
 Command Line Interface
 Accessing [197](#)
 Introduction [197](#)
 Configuration file [51](#)
 Backup [180](#)
 Restore [51](#), [180](#)
 Connecting Cables [3](#)
 Console port [31](#)
 Settings [40](#)
 Copyright [1](#)
 Corrosive Liquids [3](#)

Covers [3](#)
CPU management port [86](#)
CRC (Cyclic Redundant Check) [63](#)
Current date [69](#)
Current time [69](#)

D

Damage [3](#)
Dampness [3](#)
Danger [3](#)
DHCP [27](#)
DHCP (Dynamic Host Configuration Protocol) [27](#)
DHCP Relay [175](#)
DHCP Relay Agent Information [175](#)
Diagnostic [185](#)

- Ethernet port test [185](#)
- Ping [185](#)
- System log [185](#)

Double-tagged Frames [155](#)
Dust [3](#)
DVLAN Table [243](#)
Dynamic link aggregation [111](#)

E

Egress port [88](#)
Electric Shock [3](#)
Electrical Pipes [3](#)
Electrocution [3](#)
Ethernet broadcast address [195](#)
Ethernet port test [185](#)
Ethernet ports [40](#)

- Default settings [40](#)

Europe [3](#)
Exposure [3](#)
Extended authentication protocol [117](#)
External authentication server [117](#)

F

FCC
Compliance [2](#)
Feature
Hardware [30](#)

File Transfer using FTP
command example [183](#)
Filename convention [182](#)
Filtering [91](#)
Filtering database [193](#)
Firmware [66](#)

- Upgrade [179](#), [189](#)

Flow control [76](#)

- Back pressure [76](#)
- IEEE802.3x [76](#)

Front panel [39](#)
FTP [182](#)

- File transfer procedure [183](#)
- Restrictions over WAN [184](#)

G

GARP [78](#), [244](#)
GARP (Generic Attribute Registration Protocol) [78](#)
garp status [245](#)
GARP Status Command [245](#)
GARP terminology [78](#)
GARP timer [71](#), [78](#)
Gas Pipes [3](#)
General setup [67](#)
Getting help [53](#)
GMT (Greenwich Mean Time) [69](#)
GVRP [78](#), [85](#), [244](#)
GVRP (GARP VLAN Registration Protocol) [78](#), [237](#)
gvrp disable [247](#)
gvrp enable [246](#)
gvrp status [246](#)

H

Hardware installation [35](#)
Hardware overview [39](#)
High Voltage Points [3](#)
Host IDs [267](#)
How SSH works [130](#)
HTTPS [131](#)
HTTPS Example [132](#)

I

IEEE 802.1p [71](#)
 IEEE 802.1Q Tagged VLAN [243](#)
 IEEE 802.1x [117](#)
 Activate [118](#)
 Note [117](#)
 Reauthentication [120](#)
 IGMP snooping [161](#)
 Ingress port [88](#)
 Installation
 Freestanding [35](#)
 Precautions [36](#)
 Rack-mounting [36](#)
 Introduction [27](#)
 IP Addressing [267](#)
 IP Classes [267](#)
 IP interface [72](#)
 IP setup [71](#)
 iStacking [29](#)

L

LACP [111](#)
 System priority [115](#)
 Timeout [115](#)
 LEDs [43](#)
 Lightning [3](#)
 Limit MAC address learning [123](#)
 Link Aggregate Control Protocol (LACP) [111](#)
 Link aggregation [28](#), [111](#)
 Dynamic [111](#)
 ID information [112](#)
 Setup [113](#)
 Status [113](#)
 Liquids, Corrosive [3](#)
 Lockout [50](#)
 Log [185](#)
 Login [45](#)
 Password [50](#)
 Login account [128](#)
 Administrator [128](#)
 Non-administrator [128](#)
 Number of [128](#)
 Login password [129](#)

M

MAC (Media Access Control) [66](#)
 MAC address [66](#), [195](#)
 Maximum number per port [123](#)
 MAC address learning [28](#), [70](#), [89](#), [123](#)
 Specify limit [123](#)
 MAC table [193](#)
 How it works [193](#)
 View [194](#)
 Maintenance [179](#)
 Management Information Base (MIB) [126](#)
 Management port [88](#)
 MIB [126](#)
 Supported MIBs [127](#)
 Mini GBIC ports [41](#)
 Connection speed [41](#)
 Connector type [41](#)
 Transceiver installation [41](#)
 Transceiver removal [42](#)
 Mirror port [107](#)
 Modifications [2](#)
 Mounting brackets [36](#)
 MSA (MultiSource Agreement) [41](#)
 MTU (Multi-Tenant Unit) [69](#)

N

Network management system (NMS) [126](#)
 North America [3](#)
 NTP (RFC-1305) [69](#)

O

Opening [3](#)

P

Password [50](#), [192](#)
 Ping [185](#)
 Pipes [3](#)
 Pool [3](#)
 Port authentication [117](#)
 IEEE802.1x [118](#)
 RADIUS server [118](#)

- Port Based VLAN Type [70](#)
- Port details [61](#)
- Port isolation [85](#), [88](#)
- Port Mirroring [220](#), [237](#)
- Port mirroring [28](#), [107](#)
- Port redundancy [111](#)
- Port security [28](#)
 - Limit MAC address learning [123](#)
- Port setup [74](#)
- Port speed/duplex [76](#)
- Port status [59](#)
- Port VID
 - Default for all ports [218](#)
- Port VLAN trunking [79](#)
- Port-based VLAN [85](#)
 - All connected [88](#)
 - Port isolation [88](#)
 - Setting Wizard [88](#)
- Power Adaptor [3](#)
- Power Cord [3](#)
- Power Outlet [3](#)
- Power Supply [3](#)
- Power Supply, repair [3](#)
- Priority [71](#)
- Priority level [71](#)
- Priority queue assignment [71](#)
- Product specification [263](#)
- PVID [77](#), [85](#)
- PVID (Priority Frame) [77](#)

Q

- Qualified Service Personnel [3](#)
- Queuing [27](#), [139](#)
- Queuing algorithm [139](#), [141](#)
- Queuing method [139](#), [141](#)

R

- RADIUS [117](#)
- RADIUS (Remote Authentication Dial In User Service) [117](#)
- RADIUS server [117](#)
 - Advantages [117](#)
 - Network example [117](#)
 - Settings [118](#)
- Rapid Spanning Tree Protocol [93](#)

- Related Documentation [25](#)
- Remote management [136](#)
 - Service [137](#)
 - Trusted computers [137](#)
- Removing [3](#)
- Repair [3](#)
- Reset [51](#)
- Reset to factory default settings [181](#)
- Restore configuration [51](#)
- Risk [3](#)
- Risks [3](#)
- RSTP [93](#)
- RSTP (Rapid STP) [28](#)
- Rubber feet [35](#)

S

- Safety Warnings [3](#)
- Service [3](#), [4](#)
- Service access control [135](#)
 - Service port [136](#)
- Service Personnel [3](#)
- Service Provider Tag Protocol Identifier [157](#)
- Service Provider's Network [155](#)
- Shock, Electric [3](#)
- Simple Network Management Protocol (SNMP) [126](#)
- SNMP [126](#)
 - Agent [126](#)
 - Communities [128](#)
 - Management model [126](#)
 - Manager [126](#)
 - MIB [126](#), [127](#)
 - Network components [126](#)
 - Object variables [126](#)
 - Protocol operations [126](#)
 - Setup [127](#)
 - Traps [127](#)
 - Versions supported [126](#)
- SP TPID [157](#)
- Spanning Tree Protocol (STP) [93](#)
- SSH [130](#)
- SSH Implementation [131](#)
- Static MAC address [28](#), [89](#)
- Static MAC forwarding [89](#)
- Static VLAN [81](#)
 - Control [83](#)
 - Tagging [83](#)
- Status [46](#), [59](#)
 - LED [43](#)
 - Link aggregation [113](#)
 - Port [59](#)

- Port details [61](#)
- STP [94](#)
- VLAN [80](#)
- STP [93](#)
 - Bridge ID [95](#)
 - Bridge priority [98](#)
 - Configuration [96](#)
 - Designated bridge [94](#)
 - Forwarding Delay [98](#)
 - Hello BPDU [94](#)
 - Hello Time [95, 98](#)
 - How it works [94](#)
 - Max Age [95, 98](#)
 - Path cost [93, 98](#)
 - Port priority [98](#)
 - Port state [94](#)
 - Root port [94](#)
 - Status [94](#)
 - Terminology [93](#)
- STP (Spanning Tree Protocol) [28](#)
- Subnet Masks [268](#)
- Subnetting [268](#)
- Supply Voltage [3](#)
- SVLAN Table [243](#)
- Swimming Pool [3](#)
- Switch lockout [50](#)
- Switch reset [51](#)
- Switch setup [70](#)
- Syntax Conventions [25](#)
- sys Commands
 - examples [225, 231, 234](#)
- sys log disp [226, 231, 234](#)
- sys sw mac list [227](#)
- System information [65](#)
- System log [185](#)
- System reboot [181](#)
- System up time [60](#)

T

- Tagged VLAN [77](#)
- Telecommunication Line Cord. [3](#)
- Thunderstorm [3](#)
- Time
 - Current [69](#)
 - Time zone [69](#)
 - Timeserver [69](#)
- Time (RFC-868) [69](#)
- Time service protocol [69](#)
 - Time format [69](#)
- Time zone [69](#)

- Timeserver [69](#)
- Transceiver
 - Installation [41](#)
 - Removal [42](#)
- Trap
 - Destination [128](#)
- Traps [127](#)
- Trunk group [111](#)
- Trunking [28, 111](#)

U

- UTC (Universal Time Coordinated) [69](#)

V

- Vendor [3](#)
- Ventilation [35](#)
- Ventilation holes [35](#)
- Ventilation Slots [3](#)
- VID [77, 81, 157](#)
 - Number of possible VIDs [77](#)
 - Priority frame [77](#)
- VID (VLAN Identifier) [77](#)
- VLAN [69, 77](#)
 - Acceptable frame type [85](#)
 - Automatic registration [78](#)
 - Explicit Tagging [243](#)
 - ID [77](#)
 - ID (VID) [244](#)
 - Implicit Tagging [243](#)
 - Ingress filtering [85](#)
 - Introduction [69](#)
 - Number of VLANs [81](#)
 - Port isolation [85](#)
 - Port number [81](#)
 - Port settings [83](#)
 - Port-based VLAN [85](#)
 - Registration Information [243](#)
 - Static VLAN [81](#)
 - Status [80, 81](#)
 - Tagged [77](#)
 - Trunking [79](#)
 - Type [70, 79](#)
- VLAN (Virtual Local Area Network) [27, 69](#)
- VLAN Databases [243](#)
- VLAN Stacking [155](#)
- VLAN trunking [85](#)
- vlan1q port accept [247](#)
- vlan1q port gvrp [248](#)

vlan1q svlan active [250](#)
vlan1q svlan delentry [249](#)
vlan1q svlan inactive [250](#)
vlan1q svlan list [250](#)
vlan1q svlan setentry [248](#)
Voltage Supply [3](#)
Voltage, High [3](#)

W

Wall Mount [3](#)
Warnings [3](#)
Water [3](#)
Water Pipes [3](#)
Web configuration
 Screen summary [47](#)
Web configurator
 Getting help [53](#)
 Home [46](#)
 Login [45](#)
 Logout [53](#)
 Navigation panel [46](#)
Wet Basement [3](#)

Z

ZyNOS (ZyXEL Network Operating System) [182](#)
ZyXEL Limited Warranty
 Note [4](#)