

ES-2108 Series

Ethernet Switch

User's Guide

Version 3.70

10/2006

Edition 2

The logo for ZyXEL, featuring the word "ZyXEL" in a bold, blue, sans-serif font. The "Z" and "y" are lowercase, while "XEL" are uppercase. The letters are closely spaced and have a slight shadow effect.

Copyright

Copyright © 2006 by ZyXEL Communications Corporation.

The contents of this publication may not be reproduced in any part or as a whole, transcribed, stored in a retrieval system, translated into any language, or transmitted in any form or by any means, electronic, mechanical, magnetic, optical, chemical, photocopying, manual, or otherwise, without the prior written permission of ZyXEL Communications Corporation.

Published by ZyXEL Communications Corporation. All rights reserved.

Disclaimer

ZyXEL does not assume any liability arising out of the application or use of any products, or software described herein. Neither does it convey any license under its patent rights nor the patent rights of others. ZyXEL further reserves the right to make changes in any products described herein without notice. This publication is subject to change without notice.

Trademarks

ZyNOS (ZyXEL Network Operating System) is a registered trademark of ZyXEL Communications, Inc. Other trademarks mentioned in this publication are used for identification purposes only and may be properties of their respective owners.

Certifications

Federal Communications Commission (FCC) Interference Statement

This device complies with Part 15 of FCC rules. Operation is subject to the following two conditions:

- This device may not cause harmful interference.
- This device must accept any interference received, including interference that may cause undesired operations.

FCC Warning

This device has been tested and found to comply with the limits for a Class A digital switch, pursuant to Part 15 of the FCC Rules. These limits are designed to provide reasonable protection against harmful interference in a commercial environment. This device generates, uses, and can radiate radio frequency energy and, if not installed and used in accordance with the instruction manual, may cause harmful interference to radio communications. Operation of this device in a residential area is likely to cause harmful interference in which case the user will be required to correct the interference at his own expense.

CE Mark Warning:

This is a class A product. In a domestic environment this product may cause radio interference in which case the user may be required to take adequate measures.

Taiwanese BSMI (Bureau of Standards, Metrology and Inspection) A Warning:

警告使用者
這是甲類的資訊產品，在居住的環境使用時，
可能造成射頻干擾，在這種情況下，
使用者會被要求採取某些適當的對策。

Notices

Changes or modifications not expressly approved by the party responsible for compliance could void the user's authority to operate the equipment.

This Class A digital apparatus complies with Canadian ICES-003.

Cet appareil numérique de la classe A est conforme à la norme NMB-003 du Canada.

Viewing Certifications

- 1 Go to <http://www.zyxel.com>.

- 2** Select your product from the drop-down list box on the ZyXEL home page to go to that product's page.
- 3** Select the certification you wish to view from this page.

Safety Warnings

For your safety, be sure to read and follow all warning notices and instructions.

- Do NOT use this product near water, for example, in a wet basement or near a swimming pool.
- Do NOT expose your device to dampness, dust or corrosive liquids.
- Do NOT store things on the device.
- Do NOT install, use, or service this device during a thunderstorm. There is a remote risk of electric shock from lightning.
- Connect ONLY suitable accessories to the device.
- Do NOT open the device or unit. Opening or removing covers can expose you to dangerous high voltage points or other risks. ONLY qualified service personnel should service or disassemble this device. Please contact your vendor for further information. Make sure to connect the cables to the correct ports.
- Place connecting cables carefully so that no one will step on them or stumble over them.
- Always disconnect all cables from this device before servicing or disassembling.
- Use ONLY an appropriate power adaptor or cord for your device.
- Connect the power adaptor or cord to the right supply voltage (for example, 110V AC in North America or 230V AC in Europe).
- Do NOT allow anything to rest on the power adaptor or cord and do NOT place the product where anyone can walk on the power adaptor or cord.
- Do NOT use the device if the power adaptor or cord is damaged as it might cause electrocution.
- If the power adaptor or cord is damaged, remove it from the power outlet.
- Do NOT attempt to repair the power adaptor or cord. Contact your local vendor to order a new one.
- Do not use the device outside, and make sure all the connections are indoors. There is a remote risk of electric shock from lightning.
- **CAUTION: RISK OF EXPLOSION IF BATTERY (on the motherboard) IS REPLACED BY AN INCORRECT TYPE. DISPOSE OF USED BATTERIES ACCORDING TO THE INSTRUCTIONS.** Dispose them at the applicable collection point for the recycling of electrical and electronic equipment. For detailed information about recycling of this product, please contact your local city office, your household waste disposal service or the store where you purchased the product.
- Do NOT obstruct the device ventilation slots, as insufficient airflow may harm your device.

This product is recyclable. Dispose of it properly.

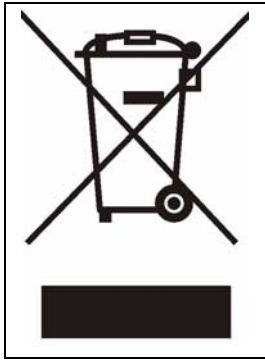

ZyXEL Limited Warranty

ZyXEL warrants to the original end user (purchaser) that this product is free from any defects in materials or workmanship for a period of up to two years from the date of purchase. During the warranty period, and upon proof of purchase, should the product have indications of failure due to faulty workmanship and/or materials, ZyXEL will, at its discretion, repair or replace the defective products or components without charge for either parts or labor, and to whatever extent it shall deem necessary to restore the product or components to proper operating condition. Any replacement will consist of a new or re-manufactured functionally equivalent product of equal or higher value, and will be solely at the discretion of ZyXEL. This warranty shall not apply if the product has been modified, misused, tampered with, damaged by an act of God, or subjected to abnormal working conditions.

Note

Repair or replacement, as provided under this warranty, is the exclusive remedy of the purchaser. This warranty is in lieu of all other warranties, express or implied, including any implied warranty of merchantability or fitness for a particular use or purpose. ZyXEL shall in no event be held liable for indirect or consequential damages of any kind to the purchaser.

To obtain the services of this warranty, contact ZyXEL's Service Center for your Return Material Authorization number (RMA). Products must be returned Postage Prepaid. It is recommended that the unit be insured when shipped. Any returned products without proof of purchase or those with an out-dated warranty will be repaired or replaced (at the discretion of ZyXEL) and the customer will be billed for parts and labor. All repaired or replaced products will be shipped by ZyXEL to the corresponding return address, Postage Paid. This warranty gives you specific legal rights, and you may also have other rights that vary from country to country.

Registration

Register your product online to receive e-mail notices of firmware upgrades and information at www.zyxel.com for global products, or at www.us.zyxel.com for North American products.

Customer Support

Please have the following information ready when you contact customer support.

- Product model and serial number.
- Warranty Information.
- Date that you received your device.
- Brief description of the problem and the steps you took to solve it.

METHOD	SUPPORT E-MAIL	TELEPHONE	WEB SITE	REGULAR MAIL
LOCATION	SALES E-MAIL	FAX	FTP SITE	
CORPORATE HEADQUARTERS (WORLDWIDE)	support@zyxel.com.tw	+886-3-578-3942	www.zyxel.com www.europe.zyxel.com	ZyXEL Communications Corp. 6 Innovation Road II Science Park Hsinchu 300 Taiwan
	sales@zyxel.com.tw	+886-3-578-2439	ftp.zyxel.com ftp.europe.zyxel.com	
COSTA RICA	soporte@zyxel.co.cr	+506-2017878	www.zyxel.co.cr	ZyXEL Costa Rica Plaza Roble Escazú Etapa El Patio, Tercer Piso San José, Costa Rica
	sales@zyxel.co.cr	+506-2015098	ftp.zyxel.co.cr	
CZECH REPUBLIC	info@cz.zyxel.com	+420-241-091-350	www.zyxel.cz	ZyXEL Communications Czech s.r.o. Modranská 621 143 01 Praha 4 - Modrany Ceská Republika
	info@cz.zyxel.com	+420-241-091-359		
DENMARK	support@zyxel.dk	+45-39-55-07-00	www.zyxel.dk	ZyXEL Communications A/S Columbusvej 2860 Soeborg Denmark
	sales@zyxel.dk	+45-39-55-07-07		
FINLAND	support@zyxel.fi	+358-9-4780-8411	www.zyxel.fi	ZyXEL Communications Oy Malminkaari 10 00700 Helsinki Finland
	sales@zyxel.fi	+358-9-4780 8448		
FRANCE	info@zyxel.fr	+33-4-72-52-97-97	www.zyxel.fr	ZyXEL France 1 rue des Vergers Bat. 1 / C 69760 Limonest France
		+33-4-72-52-19-20		
GERMANY	support@zyxel.de	+49-2405-6909-0	www.zyxel.de	ZyXEL Deutschland GmbH. Adenauerstr. 20/A2 D-52146 Wuerselen Germany
	sales@zyxel.de	+49-2405-6909-99		
HUNGARY	support@zyxel.hu	+36-1-3361649	www.zyxel.hu	ZyXEL Hungary 48, Zoldlomb Str. H-1025, Budapest Hungary
	info@zyxel.hu	+36-1-3259100		
KAZAKHSTAN	http://zyxel.kz/support	+7-3272-590-698	www.zyxel.kz	ZyXEL Kazakhstan 43, Dostyk ave., Office 414 Dostyk Business Centre 050010, Almaty Republic of Kazakhstan
	sales@zyxel.kz	+7-3272-590-689		
NORTH AMERICA	support@zyxel.com	1-800-255-4101 +1-714-632-0882	www.us.zyxel.com	ZyXEL Communications Inc. 1130 N. Miller St. Anaheim CA 92806-2001 U.S.A.
	sales@zyxel.com	+1-714-632-0858	ftp.us.zyxel.com	

LOCATION	METHOD	SUPPORT E-MAIL	TELEPHONE	WEB SITE	REGULAR MAIL
		SALES E-MAIL	FAX	FTP SITE	
NORWAY		support@zyxel.no	+47-22-80-61-80	www.zyxel.no	ZyXEL Communications A/S Niils Hansens vei 13 0667 Oslo Norway
		sales@zyxel.no	+47-22-80-61-81		
POLAND		info@pl.zyxel.com	+48 (22) 333 8250	www.pl.zyxel.com	ZyXEL Communications ul. Okrzei 1A 03-715 Warszawa Poland
			+48 (22) 333 8251		
RUSSIA		http://zyxel.ru/support	+7-095-542-89-29	www.zyxel.ru	ZyXEL Russia Ostrovityanova 37a Str. Moscow, 117279 Russia
		sales@zyxel.ru	+7-095-542-89-25		
SPAIN		support@zyxel.es	+34-902-195-420	www.zyxel.es	ZyXEL Communications Arte, 21 5 ^a planta 28033 Madrid Spain
		sales@zyxel.es	+34-913-005-345		
SWEDEN		support@zyxel.se	+46-31-744-7700	www.zyxel.se	ZyXEL Communications A/S Sjöporten 4, 41764 Göteborg Sweden
		sales@zyxel.se	+46-31-744-7701		
UKRAINE		support@ua.zyxel.com	+380-44-247-69-78	www.ua.zyxel.com	ZyXEL Ukraine 13, Pimonenko Str. Kiev, 04050 Ukraine
		sales@ua.zyxel.com	+380-44-494-49-32		
UNITED KINGDOM		support@zyxel.co.uk	+44-1344 303044 08707 555779 (UK only)	www.zyxel.co.uk	ZyXEL Communications UK Ltd., 11 The Courtyard, Eastern Road, Bracknell, Berkshire, RG12 2XB, United Kingdom (UK)
		sales@zyxel.co.uk	+44-1344 303034	ftp.zyxel.co.uk	

+” is the (prefix) number you enter to make an international telephone call.

Table of Contents

Copyright	3
Certifications	4
Safety Warnings	6
ZyXEL Limited Warranty	8
Customer Support	9
Table of Contents	11
List of Figures	21
List of Tables	25
Preface	29
Chapter 1	
Getting to Know Your Switch	31
1.1 Introduction	31
1.2 Software Features	31
1.3 Hardware Features	33
1.4 Applications	34
1.4.1 Backbone Application	34
1.4.2 Bridging Example	35
1.4.3 High Performance Switched Example	35
1.4.4 IEEE 802.1Q VLAN Application Examples	36
1.4.4.1 Tag-based VLAN Example	36
1.4.4.2 VLAN Shared Server Example	37
Chapter 2	
Hardware Installation and Connection	39
2.1 Freestanding Installation	39
2.2 Mounting the Switch on a Rack	40
2.2.1 Rack-mounted Installation Requirements	40
2.2.1.1 Precautions	40
2.2.2 Attaching the Mounting Brackets to the Switch	40
2.2.3 Mounting the Switch on a Rack	40
2.3 Wall-mounting Installation	41

Chapter 3	
Hardware Overview	43
3.1 Front Panel Connection	43
3.1.1 Console Port	45
3.1.2 Ethernet Ports	45
3.1.2.1 Default Ethernet Settings	45
3.1.3 Fast Ethernet SFP Slot	45
3.1.4 Mini-GBIC Slot	46
3.1.4.1 Transceiver Installation	46
3.1.4.2 Transceiver Removal	47
3.1.5 100 Base-FX Fiber-Optic Port	47
3.2 Rear Panel	48
3.2.1 Power Connector	48
3.3 LEDs	48
Chapter 4	
The Web Configurator	51
4.1 Introduction	51
4.2 System Login	51
4.3 The Status Screen	52
4.3.1 Change Your Password	56
4.4 Saving Your Configuration	56
4.5 Switch Lockout	57
4.6 Resetting the Switch	57
4.6.1 Reload the Factory-default Configuration File	57
4.7 Logging Out of the Web Configurator	58
4.8 Help	58
Chapter 5	
Initial Setup Example	59
5.1 Overview	59
5.1.1 Creating a VLAN	59
5.1.2 Setting Port VID	60
5.1.3 Configuring Switch Management IP Address	61
Chapter 6	
System Status and Port Statistics	63
6.1 Port Status Overview	63
6.1.1 Status: Port Details	65
Chapter 7	
Basic Setting	71
7.1 Overview	71

7.2 System Information	71
7.3 General Setup	73
7.4 Introduction to VLANs	75
7.5 Switch Setup Screen	76
7.6 IP Setup	77
7.6.1 Management IP Addresses	78
7.7 Port Setup	80
Chapter 8	
VLAN	83
8.1 Introduction to IEEE 802.1Q Tagged VLAN	83
8.1.1 Forwarding Tagged and Untagged Frames	83
8.2 Automatic VLAN Registration	84
8.2.1 GARP	84
8.2.1.1 GARP Timers	84
8.2.2 GVRP	84
8.3 Port VLAN Trunking	85
8.4 Select the VLAN Type	85
8.5 Static VLAN	86
8.5.1 Static VLAN Status	86
8.5.2 Static VLAN Details	87
8.5.3 Configure a Static VLAN	87
8.5.4 Configure VLAN Port Settings	89
8.6 Port Based VLAN Setup	91
8.6.1 Configure a Port-based VLAN	91
Chapter 9	
Static MAC Forwarding	95
9.1 Overview	95
9.2 Configuring Static MAC Forwarding	95
Chapter 10	
Filtering	99
10.1 Configure a Filtering Rule	99
Chapter 11	
Spanning Tree Protocol	101
11.1 STP/RSTP Overview	101
11.1.1 STP Terminology	101
11.1.2 How STP Works	102
11.1.3 STP Port States	102
11.2 Rapid Spanning Tree Protocol Status	102
11.3 Configure Rapid Spanning Tree Protocol	104

Chapter 12	
Bandwidth Control	107
12.1 Bandwidth Control Setup	107
Chapter 13	
Broadcast Storm Control.....	109
13.1 Broadcast Storm Control Setup	109
Chapter 14	
Mirroring	111
14.1 Port Mirroring Setup	111
Chapter 15	
Link Aggregation.....	113
15.1 Link Aggregation Overview	113
15.2 Dynamic Link Aggregation	113
15.2.1 Link Aggregation ID	114
15.3 Link Aggregation Control Protocol Status	114
15.4 Link Aggregation Setup	115
Chapter 16	
Port Authentication.....	117
16.1 Port Authentication Overview	117
16.1.1 RADIUS	117
16.1.1.1 Vendor Specific Attribute	117
16.1.1.2 Tunnel Protocol Attribute	118
16.2 Port Authentication Configuration	118
16.2.1 Configuring RADIUS Server Settings	119
16.2.2 Activate IEEE 802.1x Security	119
Chapter 17	
Port Security.....	121
17.1 Port Security Overview	121
17.2 Port Security Setup	121
17.3 Port Security Example	123
Chapter 18	
Queuing Method.....	125
18.1 Queuing Method Overview	125
18.1.1 Strict Priority Queuing (SPQ)	125
18.1.2 Weighted Round Robin Scheduling (WRR)	125
18.2 Configuring Queuing Method	126

Chapter 19	
Multicast	127
19.1 Multicast Overview	127
19.1.1 IP Multicast Addresses	127
19.1.2 IGMP Filtering	127
19.1.3 IGMP Snooping	127
19.2 Multicast Status	128
19.3 Multicast Setting	128
19.4 IGMP Filtering Profile	130
19.5 MVR Overview	132
19.5.1 Types of MVR Ports	132
19.5.2 MVR Modes	132
19.5.3 How MVR Works	133
19.6 General MVR Configuration	133
19.7 MVR Group Configuration	135
19.7.1 MVR Configuration Example	137
Chapter 20	
Static Route	139
20.1 Configuring Static Routing	139
Chapter 21	
Differentiated Services	141
21.1 DiffServ Overview	141
21.1.1 DSCP and Per-Hop Behavior	141
21.1.2 DiffServ Network Example	141
21.2 Activating DiffServ	142
21.3 DSCP-to-IEEE802.1p Priority Mapping Settings	143
21.3.1 Configuring DSCP Settings	143
Chapter 22	
Maintenance	145
22.1 The Maintenance Screen	145
22.2 Load Factory Default	146
22.3 Save Configuration	146
22.4 Reboot System	147
22.5 Firmware Upgrade	147
22.6 Restore a Configuration File	147
22.7 Backup Configuration File	148
22.8 FTP Command Line	148
22.8.1 Filename Conventions	149
22.8.1.1 Example FTP Commands	149
22.8.2 FTP Command Line Procedure	149

22.8.3 GUI-based FTP Clients	150
22.8.4 FTP Restrictions	150
Chapter 23	
Access Control.....	151
23.1 Access Control Overview	151
23.2 The Access Control Main Screen	151
23.3 About SNMP	152
23.3.1 Supported MIBs	153
23.3.2 SNMP Traps	153
23.3.3 Configuring SNMP	153
23.4 Setting Up Login Accounts	154
23.5 SSH Overview	155
23.6 How SSH works	156
23.7 SSH Implementation on the Switch	157
23.7.1 Requirements for Using SSH	157
23.7.2 SSH Login Example	157
23.8 Introduction to HTTPS	158
23.9 HTTPS Example	159
23.9.1 Internet Explorer Warning Messages	159
23.9.2 Netscape Navigator Warning Messages	160
23.9.3 The Main Screen	161
23.10 Service Port Access Control	161
23.11 Remote Management	162
Chapter 24	
Diagnostic.....	165
24.1 Diagnostic	165
Chapter 25	
Syslog	167
25.1 Syslog Overview	167
25.2 Syslog Setup	167
25.3 Syslog Server Setup	168
Chapter 26	
Cluster Management.....	171
26.1 Clustering Management Status Overview	171
26.2 Clustering Management Status	172
26.2.1 Cluster Member Switch Management	173
26.2.1.1 Uploading Firmware to a Cluster Member Switch	173
26.3 Clustering Management Configuration	174

Chapter 27	
MAC Table	177
27.1 MAC Table Overview	177
27.2 Viewing the MAC Table	178
Chapter 28	
ARP Table	179
28.1 ARP Table Overview	179
28.1.1 How ARP Works	179
28.2 Viewing the ARP Table	179
Chapter 29	
Configure Clone	181
29.1 Configure Clone Settings	181
Chapter 30	
Introducing Commands	183
30.1 Overview	183
30.2 Accessing the CLI	183
30.2.1 The Console Port	183
30.2.1.1 Initial Screen	184
30.3 The Login Screen	184
30.4 Command Syntax Conventions	184
30.5 Changing the Password	185
30.6 Privilege Levels	185
30.7 Command Modes	186
30.8 Getting Help	187
30.8.1 List of Available Commands	188
30.9 Using Command History	189
30.10 Saving Your Configuration	189
30.10.1 Switch Configuration File	189
30.10.2 Logging Out	190
30.11 Command Summary	190
30.11.1 User Mode	190
30.11.2 Enable Mode	191
30.11.3 General Configuration Mode	196
30.11.4 interface port-channel Commands	206
30.11.5 config-vlan Commands	209
30.11.6 mvr Commands	210
Chapter 31	
User and Enable Mode Commands	213
31.1 Overview	213

31.2 show Commands	213
31.2.1 show system-information	213
31.2.2 show ip	214
31.2.3 show logging	214
31.2.4 show interface	214
31.2.5 show mac address-table	215
31.3 ping	216
31.4 traceroute	216
31.5 Copy Port Attributes	217
31.5.1 Resetting to the Factory Default	218

Chapter 32

Configuration Mode Commands..... 219

32.1 Enabling IGMP Snooping	219
32.2 Configure IGMP Filter	220
32.3 Enabling STP	221
32.4 no Command Examples	222
32.4.1 Disable Commands	222
32.4.2 Resetting Commands	223
32.4.3 Re-enable commands	223
32.4.4 Other Examples of no Commands	223
32.4.4.1 no trunk	224
32.4.4.2 no port-access-authenticator	224
32.4.4.3 no ssh	225
32.5 Queuing Method Commands	225
32.6 Static Route Commands	226
32.7 Enabling MAC Filtering	227
32.8 Enabling Trunking	228
32.9 Enabling Port Authentication	228
32.9.1 RADIUS Server Settings	228
32.9.2 Port Authentication Settings	229

Chapter 33

Interface Commands..... 231

33.1 Overview	231
33.2 Interface Command Examples	231
33.2.1 interface port-channel	231
33.2.2 broadcast/multicast storm control	231
33.2.3 bandwidth-limit	232
33.2.4 mirror	233
33.2.5 gvrp	233
33.2.6 frame-type	234
33.2.7 egress set	234

33.2.8 qos priority	235
33.2.9 name	235
33.2.10 speed-duplex	236
33.2.11 test	236
33.3 Interface no Command Examples	237
33.3.1 no bandwidth-limit	237
Chapter 34	
IEEE 802.1Q Tagged VLAN Commands	239
34.1 Configuring Tagged VLAN	239
34.2 Global VLAN1Q Tagged VLAN Configuration Commands	240
34.2.1 GARP Status	240
34.2.2 GARP Timer	240
34.2.3 GVRP Timer	241
34.2.4 Enable GVRP	241
34.2.5 Disable GVRP	241
34.3 Port VLAN Commands	241
34.3.1 Set Port VID	242
34.3.2 Set Acceptable Frame Type	242
34.3.3 Enable or Disable Port GVRP	242
34.3.4 Modify Static VLAN	243
34.3.4.1 Modify a Static VLAN Table Example	243
34.3.4.2 Forwarding Process Example	243
34.3.5 Delete VLAN ID	244
34.4 Enable VLAN	244
34.5 Disable VLAN	245
34.6 Show VLAN Setting	245
Chapter 35	
Multicast VLAN Registration Commands	247
35.1 Overview	247
35.2 Create Multicast VLAN	247
Chapter 36	
Troubleshooting	249
36.1 Problems Starting Up the Switch	249
36.2 Problems Accessing the Switch	249
36.2.1 Pop-up Windows, JavaScripts and Java Permissions	250
36.2.1.1 Internet Explorer Pop-up Blockers	250
36.2.1.2 JavaScripts	253
36.2.1.3 Java Permissions	254
36.3 Problems with the Password	255

Appendix A	
Product Specifications	257
Appendix B	
IP Addresses and Subnetting	261
Index	271

List of Figures

Figure 1 Backbone Application	35
Figure 2 Bridging Application	35
Figure 3 High Performance Switched Application	36
Figure 4 Tag-based VLAN Application	37
Figure 5 Shared Server Using VLAN Example	37
Figure 6 Attaching Rubber Feet	39
Figure 7 Attaching the Mounting Brackets	40
Figure 8 Mounting the Switch on a Rack	41
Figure 9 Front Panel: ES-2108	43
Figure 10 Front Panel: ES-2108-F	43
Figure 11 Front Panel: ES-2108-G/ES-2108PWR	43
Figure 12 Front Panel: ES-2108-LC	44
Figure 13 Transceiver Installation Example	46
Figure 14 Installed Transceiver	47
Figure 15 Opening the Transceiver's Latch Example	47
Figure 16 Transceiver Removal Example	47
Figure 17 Rear Panel	48
Figure 18 Web Configurator: Login	52
Figure 19 Web Configurator Home Screen (Status)	52
Figure 20 Change Administrator Login Password	56
Figure 21 Resetting the Switch: Via the Console Port	58
Figure 22 Web Configurator: Logout Screen	58
Figure 23 Initial Setup Network Example: VLAN	59
Figure 24 Initial Setup Network Example: Port VID	61
Figure 25 Initial Setup Example: Management IP Address	62
Figure 26 Status (ES-2108PWR)	63
Figure 27 Status (ES-2108-G)	64
Figure 28 Status: Port Details (ES-2108PWR)	66
Figure 29 Status: Port Details (ES-2108-G)	67
Figure 30 System Info (ES-2108PWR)	72
Figure 31 System Info (ES-2108-G)	72
Figure 32 General Setup	74
Figure 33 Switch Setup	76
Figure 34 IP Setup	78
Figure 35 Port Setup (ES-2108PWR)	80
Figure 36 Port Setup (ES-2108-G)	81
Figure 37 Port VLAN Trunking	85
Figure 38 Switch Setup: Select VLAN Type	86

Figure 39 VLAN: VLAN Status	86
Figure 40 Static VLAN Details	87
Figure 41 VLAN: Static VLAN	88
Figure 42 VLAN: VLAN Port Setting	90
Figure 43 Port Based VLAN Setup (All Connected)	92
Figure 44 Port Based VLAN Setup (Port Isolation)	93
Figure 45 Static MAC Forwarding	96
Figure 46 Filtering	99
Figure 47 Spanning Tree Protocol: Status	103
Figure 48 Spanning Tree Protocol: Configuration	104
Figure 49 Bandwidth Control	107
Figure 50 Broadcast Storm Control	109
Figure 51 Mirroring	111
Figure 52 Link Aggregation Control Protocol Status	114
Figure 53 Link Aggregation: Configuration	115
Figure 54 RADIUS Server	117
Figure 55 Port Authentication	119
Figure 56 Port Authentication: RADIUS	119
Figure 57 Port Authentication: 802.1x	120
Figure 58 Port Security	122
Figure 59 Port Security Example	123
Figure 60 Queuing Method	126
Figure 61 Multicast Status.	128
Figure 62 Multicast Setting	129
Figure 63 Multicast: IGMP Filtering Profile	131
Figure 64 MVR Network Example	132
Figure 65 MVR Multicast Television Example	133
Figure 66 MVR	134
Figure 67 MVR: Group Configuration	136
Figure 68 MVR Configuration Example	137
Figure 69 MVR Configuration Example	137
Figure 70 MVR Group Configuration Example	138
Figure 71 MVR Group Configuration Example	138
Figure 72 Static Routing	139
Figure 73 DiffServ: Differentiated Service Field	141
Figure 74 DiffServ Network Example	142
Figure 75 DiffServ	142
Figure 76 DiffServ: DSCP Setting	144
Figure 77 Maintenance	145
Figure 78 Load Factory Default: Confirmation	146
Figure 79 Firmware Upgrade	147
Figure 80 Restore Configuration	148
Figure 81 Backup Configuration	148

Figure 82 Access Control	151
Figure 83 SNMP Management Model	152
Figure 84 Access Control: SNMP	154
Figure 85 Access Control: Logins	155
Figure 86 SSH Communication Example	156
Figure 87 How SSH Works	156
Figure 88 SSH Login Example	158
Figure 89 HTTPS Implementation	159
Figure 90 Security Alert Dialog Box (Internet Explorer)	160
Figure 91 Security Certificate 1 (Netscape)	160
Figure 92 Security Certificate 2 (Netscape)	161
Figure 93 Example: Lock Denoting a Secure Connection	161
Figure 94 Access Control: Service Access Control	162
Figure 95 Access Control: Remote Management	163
Figure 96 Diagnostic	165
Figure 97 Syslog	168
Figure 98 Syslog: Server Setup	169
Figure 99 Clustering Application Example	171
Figure 100 Clustering Management: Status	172
Figure 101 Cluster Management: Cluster Member Web Configurator Screen	173
Figure 102 Example: Uploading Firmware to a Cluster Member Switch	174
Figure 103 Clustering Management Configuration	175
Figure 104 MAC Table Flowchart	177
Figure 105 MAC Table	178
Figure 106 ARP Table	180
Figure 107 Configure Clone	181
Figure 108 no port-access-authenticator Command Example	225
Figure 109 Pop-up Blocker	251
Figure 110 Internet Options	251
Figure 111 Internet Options	252
Figure 112 Pop-up Blocker Settings	252
Figure 113 Internet Options	253
Figure 114 Security Settings - Java Scripting	254
Figure 115 Security Settings - Java	254
Figure 116 Java (Sun)	255
Figure 117 Network Number and Host ID	262
Figure 118 Subnetting Example: Before Subnetting	265
Figure 119 Subnetting Example: After Subnetting	266

List of Tables

Table 1 Model Specific Features	31
Table 2 Front Panel	44
Table 3 LEDs	48
Table 4 Navigation Panel Sub-links Overview	53
Table 5 Web Configurator Screen Sub-links Details	54
Table 6 Navigation Panel Links	54
Table 7 Status	64
Table 8 Status: Port Details	67
Table 9 System Info	72
Table 10 General Setup	74
Table 11 Switch Setup	76
Table 12 IP Setup	78
Table 13 Port Setup	81
Table 14 IEEE 802.1q Terminology	84
Table 15 VLAN: VLAN Status	86
Table 16 Static VLAN Details	87
Table 17 VLAN: Static VLAN	88
Table 18 VLAN: VLAN Port Setting	90
Table 19 Port Based VLAN Setup	93
Table 20 Static MAC Forwarding	96
Table 21 Filtering	99
Table 22 STP Path Costs	101
Table 23 STP Port States	102
Table 24 Spanning Tree Protocol: Status	103
Table 25 Spanning Tree Protocol: Configuration	104
Table 26 Bandwidth Control	107
Table 27 Broadcast Storm Control	109
Table 28 Mirroring	111
Table 29 Link Aggregation ID: Local Switch	114
Table 30 Link Aggregation ID: Peer Switch	114
Table 31 Link Aggregation Control Protocol Status	114
Table 32 Link Aggregation Control Protocol: Configuration	115
Table 33 Supported VSA	118
Table 34 Supported Tunnel Protocol Attribute	118
Table 35 Port Authentication: RADIUS	119
Table 36 Port Authentication: 802.1x	120
Table 37 Port Security	122
Table 38 Port Security Example	123

Table 39 Physical Queue Priority	125
Table 40 Queuing Method	126
Table 41 Multicast Status	128
Table 42 Multicast Setting	129
Table 43 Multicast: IGMP Filtering Profile	131
Table 44 MVR	134
Table 45 MVR: Group Configuration	136
Table 46 Static Routing	139
Table 47 DiffServ	142
Table 48 Default DSCP-IEEE802.1p Mapping	143
Table 49 DiffServ: DSCP Setting	144
Table 50 Maintenance	145
Table 51 Filename Conventions	149
Table 52 General Commands for GUI-based FTP Clients	150
Table 53 Access Control Overview	151
Table 54 SNMP Commands	152
Table 55 SNMP Traps	153
Table 56 Access Control: SNMP	154
Table 57 Access Control: Logins	155
Table 58 Access Control: Service Access Control	162
Table 59 Access Control: Remote Management	163
Table 60 Diagnostic	165
Table 61 Syslog Severity Levels	167
Table 62 Syslog	168
Table 63 Syslog: Server Setup	169
Table 64 ZyXEL Clustering Management Specifications	171
Table 65 Clustering Management: Status	172
Table 66 FTP Upload to Cluster Member Example	174
Table 67 Clustering Management Configuration	175
Table 68 MAC Table	178
Table 69 ARP Table	180
Table 70 Configure Clone	181
Table 71 Command Interpreter Mode Summary	186
Table 72 Command Summary: User Mode	190
Table 73 Command Summary: Enable Mode	191
Table 74 Command Summary: Configuration Mode	196
Table 75 interface port-channel Commands	206
Table 76 Command Summary: config-vlan Commands	209
Table 77 mvr Commands	210
Table 78 Troubleshooting the Start-Up of Your Switch	249
Table 79 Troubleshooting Accessing the Switch	249
Table 80 Troubleshooting the Password	255
Table 81 General Product Specifications	257

Table 82 Management Specifications	258
Table 83 Physical and Environmental Specifications	259
Table 84 Subnet Mask - Identifying Network Number	262
Table 85 Subnet Masks	263
Table 86 Maximum Host Numbers	263
Table 87 Alternative Subnet Mask Notation	264
Table 88 Subnet 1	266
Table 89 Subnet 2	267
Table 90 Subnet 3	267
Table 91 Subnet 4	267
Table 92 Eight Subnets	268
Table 93 24-bit Network Number Subnet Planning	268
Table 94 16-bit Network Number Subnet Planning	269

Preface

Congratulations on your purchase of the ES-2108 Series Ethernet Switch.

This preface introduces you to the ES-2108 Series Ethernet Switch and discusses the conventions of this User's Guide. It also provides information on other related documentation.

About This User's Guide

This manual is designed to guide you through the installation and configuration of your ES-2108 Series for its various applications.

Related Documentation

- Web Configurator Online Help

Embedded web help for descriptions of individual screens and supplementary information.









- ZyXEL Web Site

Please go to <http://www.zyxel.com> for product news, firmware, updated documents, and other support materials.

Syntax Conventions

- “Enter” means for you to type one or more characters. “Select” or “Choose” means for you to use one of the predefined choices.
- Command and arrow keys are enclosed in square brackets. [ENTER] means the Enter, or carriage return key; [ESC] means the Escape key and [SPACE BAR] means the Space Bar.
- Mouse action sequences are denoted using a comma. For example, “In Windows, click **Start**, **Settings** and then **Control Panel**” means first click the **Start** button, then point your mouse pointer to **Settings** and then click **Control Panel**.
- “e.g.,” is a shorthand for “for instance”, and “i.e.,” means “that is” or “in other words”.
- The ES-2108 Series may be referred to as “the ES-2108”, “the switch”, or “the device” in this User's Guide.

Graphics Icons Key

<p>ES-2108 Series</p> 	<p>Computer</p> 	<p>Server</p> 
<p>Computer</p> 	<p>DSLAM</p> 	<p>Gateway</p> 
<p>Central Office/ ISP</p> 	<p>Internet</p> 	<p>Hub/Switch</p> 

User Guide Feedback

Help us help you. E-mail all User Guide-related comments, questions or suggestions for improvement to techwriters@zyxel.com.tw or send regular mail to The Technical Writing Team, ZyXEL Communications Corp., 6 Innovation Road II, Science-Based Industrial Park, Hsinchu, 300, Taiwan. Thank you.

CHAPTER 1

Getting to Know Your Switch

This chapter introduces the main features and applications of the switch.

1.1 Introduction

This user's guide covers the following switch models: ES-2108, ES-2108-F, ES-2108-LC, ES-2108-G and ES-2108PWR. The following table lists features that are specific to the individual models. The other features discussed in this chapter are common to all of the models covered in this User's Guide.

Note: See the product specifications in the appendix for detailed features and standards support.

Table 1 Model Specific Features

FEATURE \ MODEL	ES-2108	ES-2108-F	ES-2108-LC	ES-2108-G	ES-2108PWR
Dual personality interface: a 1000 Base-T copper RJ-45 port and a Small Form-Factor Pluggable (SFP) fiber port, with one port active at a time				X	X
Fast Ethernet SFP Slot		X			
Mini-GBIC Port			X		
100 Base-FX Fiber-Optic Port			X		
IEEE 802.3af Power over Ethernet compliant Ethernet Ports					X
Fan-less design	X	X	X	X	

With its built-in web configurator, managing and configuring the switch is easy. In addition, the switch can also be managed via Telnet, SSH (Secure SHell), any terminal emulator program on the console port, or third-party SNMP management.

1.2 Software Features

This section describes the general software features of the switch.

DHCP Client

DHCP (Dynamic Host Configuration Protocol RFC 2131 and RFC 2132) allows individual computers to obtain TCP/IP configuration at start-up from a server. You can configure the switch as a DHCP client to obtain TCP/IP information (such as the IP address and subnet mask) from a DHCP server. If you disable the DHCP service, you must manually enter the TCP/IP information.

VLAN

A VLAN (Virtual Local Area Network) allows a physical network to be partitioned into multiple logical networks. Devices on a logical network belong to one group. A device can belong to more than one group. With VLAN, a device cannot directly talk to or hear from devices that are not in the same group(s); the traffic must first go through a router.

Differentiated Services (DiffServ)

With DiffServ, the switch marks packets so that they receive specific per-hop treatment at DiffServ-compliant network devices along the route based on the application types and traffic flow.

Queuing

Queuing is used to help solve performance degradation when there is network congestion. Two scheduling services are supported: Strict Priority Queuing (SPQ) and Weighted Round Robin (WRR). This allows the switch to maintain separate queues for packets from each individual source or flow and prevent a source from monopolizing the bandwidth.

Port Mirroring

Port mirroring allows you to copy traffic going from one or all ports to another or all ports in order that you can examine the traffic from the mirror port (the port you copy the traffic to) without interference.

Static Route

Static routes tell the switch how to forward IP traffic when you configure the TCP/IP parameters manually.

IGMP Snooping

The switch supports IGMP snooping enabling group multicast traffic to be only forwarded to ports that are members of that group; thus allowing you to significantly reduce multicast traffic passing through your switch.

STP (Spanning Tree Protocol) / RSTP (Rapid STP)

(R)STP detects and breaks network loops and provides backup links between switches, bridges or routers. It allows a switch to interact with other (R)STP -compliant switches in your network to ensure that only one path exists between any two stations on the network.

Link Aggregation

Link aggregation (trunking) is the grouping of physical ports into one logical higher-capacity link. You may want to trunk ports if for example, it is cheaper to use multiple lower-speed links than to under-utilize a high-speed, but more costly, single-port link.

Port Authentication and Security

For security, the switch allows authentication using IEEE 802.1x with an external RADIUS server and port security that allows only packets with dynamically learned MAC addresses and/or configured static MAC addresses to pass through a port on the switch.

Maintenance and Management Features

- Access Control
You can specify the service(s) and computer IP address(es) to control access to the switch for management.
- Cluster Management
Cluster management (also known as iStacking) allows you to manage switches through one switch, called the cluster manager. The switches must be directly connected and be in the same VLAN group so as to be able to communicate with one another.
- Configuration and Firmware Maintenance
You can backup or restore the switch configuration or upgrade the firmware on the switch.

1.3 Hardware Features

This section describes the ports on the switch.

Ethernet Ports

Connect computers or switches to the 10/100 Mbps auto-negotiating, automatic cable sensing (auto-MDIX) Ethernet RJ-45 ports.

Gigabit Ethernet Port

Available on the ES-2108-G and ES-2108PWR, the port allows the switch to connect to another WAN switch.

Mini-GBIC Slot

Install SPF transceivers in this slot to connect to other Ethernet switches at longer distances than the Ethernet port.

Console Port

Use the console port for local management of the switch.

PoE (Power over Ethernet)

The ES-2108PWR can provide power to a device (that supports PoE) such as an access point or a switch through a 10/100Mbps Ethernet port.

1.4 Applications

This section shows a few examples of using the switch in various network environments.

1.4.1 Backbone Application

In this application, the switch is an ideal solution for small networks where rapid growth can be expected in the near future.

The switch can be used standalone for a group of heavy traffic users. You can connect computers directly to the switch's port or connect other switches to the switch.

In this example, all computers can share high-speed applications on the server. To expand the network, simply add more networking devices such as switches, routers, computers, print servers etc.

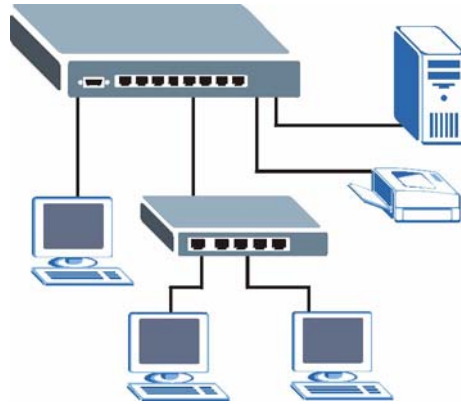
Figure 1 Backbone Application

1.4.2 Bridging Example

In this example application the switch connects different company departments (**RD** and **Sales**) to the corporate backbone. It can alleviate bandwidth contention and eliminate server and network bottlenecks. All users that need high bandwidth can connect to high-speed department servers via the switch.

For ES-2108G, you can provide a super-fast uplink connection by using a Gigabit Ethernet/mini-GBIC port on the switch.

Moreover, the switch eases supervision and maintenance by allowing network managers to centralize multiple servers at a single location.

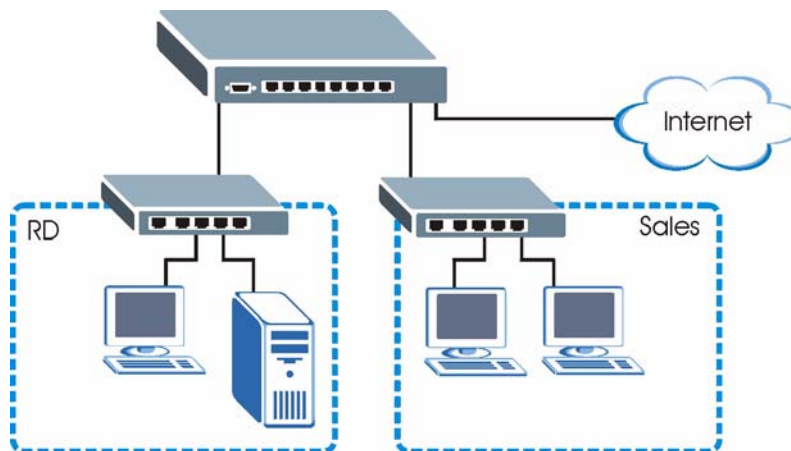
Figure 2 Bridging Application

1.4.3 High Performance Switched Example

The switch is ideal for connecting two networks that need high bandwidth. In the following example, use trunking to connect these two networks.

Switching to higher-speed LANs such as ATM (Asynchronous Transmission Mode) is not feasible for most people due to the expense of replacing all existing Ethernet cables and adapter cards, restructuring your network and complex maintenance. The switch can provide the same bandwidth as ATM at much lower cost while still being able to use existing adapters and switches. Moreover, the current LAN structure can be retained as all ports can freely communicate with each other.

Figure 3 High Performance Switched Application

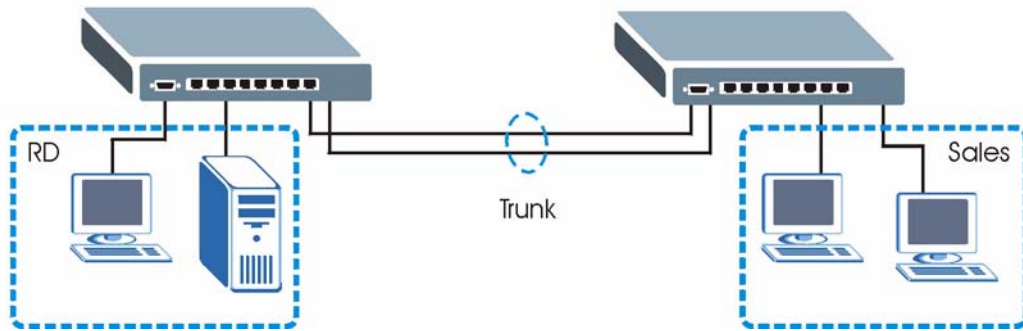

1.4.4 IEEE 802.1Q VLAN Application Examples

This section shows a workgroup and a shared server example using 802.1Q tagged VLANs.

A VLAN (Virtual Local Area Network) allows a physical network to be partitioned into multiple logical networks. Stations on a logical network belong to one group. A station can belong to more than one group. With VLAN, a station cannot directly talk to or hear from stations that are not in the same group(s) unless such traffic first goes through a router.

For more information on VLANs, refer to [Chapter 8, “VLAN” on page 83](#).

1.4.4.1 Tag-based VLAN Example

Ports in the same VLAN group share the same frame broadcast domain thus increase network performance through reduced broadcast traffic. VLAN groups can be modified at any time by adding, moving or changing ports without any re-cabling.

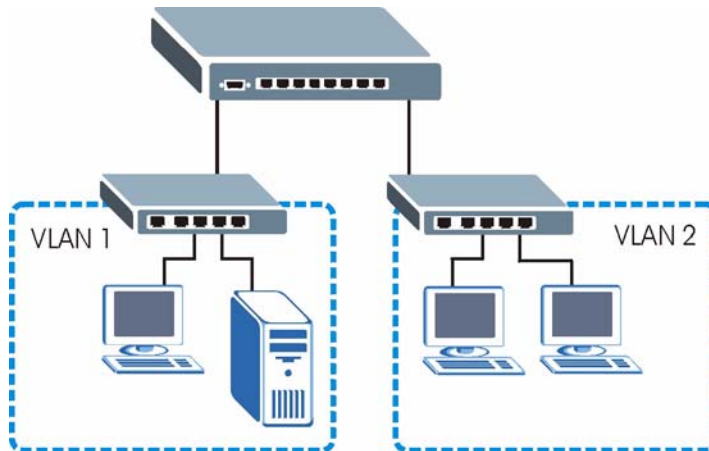
Figure 4 Tag-based VLAN Application

1.4.4.2 VLAN Shared Server Example

Shared resources such as a server can be used by all ports in the same VLAN as the server, as shown in the following example. In this example, only ports that need access to the server need belong to VLAN 1. Ports can belong to other VLAN groups too.

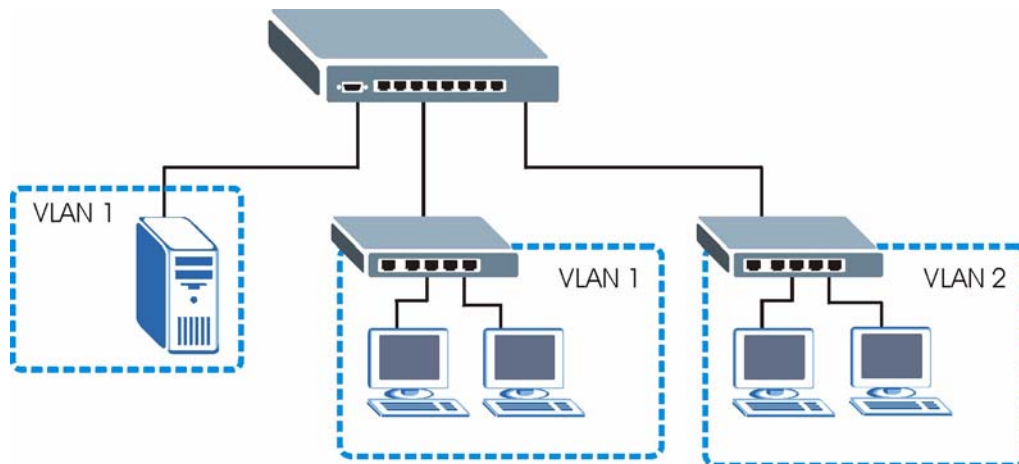
Figure 5 Shared Server Using VLAN Example

CHAPTER 2

Hardware Installation and Connection

This chapter shows you how to install and connect the switch.

2.1 Freestanding Installation

- 1 Make sure the switch is clean and dry.
- 2 Set the switch on a smooth, level surface strong enough to support the weight of the switch and the connected cables. Make sure there is a power outlet nearby.
- 3 Make sure there is enough clearance around the switch to allow air circulation and the attachment of cables and the power cord.
- 4 Remove the adhesive backing from the rubber feet.
- 5 Attach the rubber feet to each corner on the bottom of the switch. These rubber feet help protect the switch from shock or vibration and ensure space between devices when stacking.

Figure 6 Attaching Rubber Feet

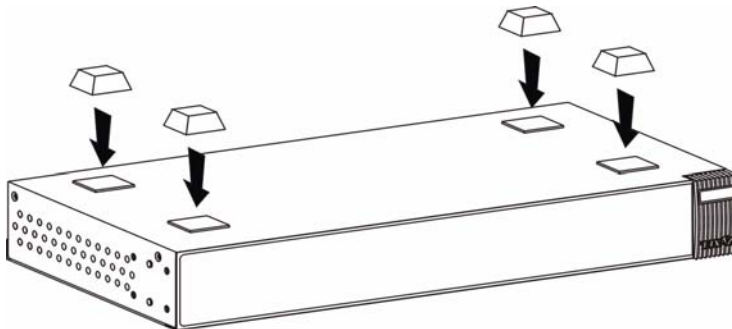

Note: Do NOT block the ventilation holes. Leave space between devices when stacking.

For proper ventilation, allow at least 4 inches (10 cm) of clearance at the front and 3.4 inches (8 cm) at the back of the switch. This is especially important for enclosed rack installations.

2.2 Mounting the Switch on a Rack

This section lists the rack mounting requirements and precautions and describes the installation steps.

2.2.1 Rack-mounted Installation Requirements

- Two mounting brackets.
- Eight M3 flat head screws and a #2 Philips screwdriver.
- Four M5 flat head screws and a #2 Philips screwdriver.

Note: Failure to use the proper screws may damage the unit.

2.2.1.1 Precautions

- Make sure the rack will safely support the combined weight of all the equipment it contains.
- Make sure the position of the switch does not make the rack unstable or top-heavy. Take all necessary precautions to anchor the rack securely before installing the unit.

2.2.2 Attaching the Mounting Brackets to the Switch

- 1 Position a mounting bracket on one side of the switch, lining up the four screw holes on the bracket with the screw holes on the side of the switch.

Figure 7 Attaching the Mounting Brackets

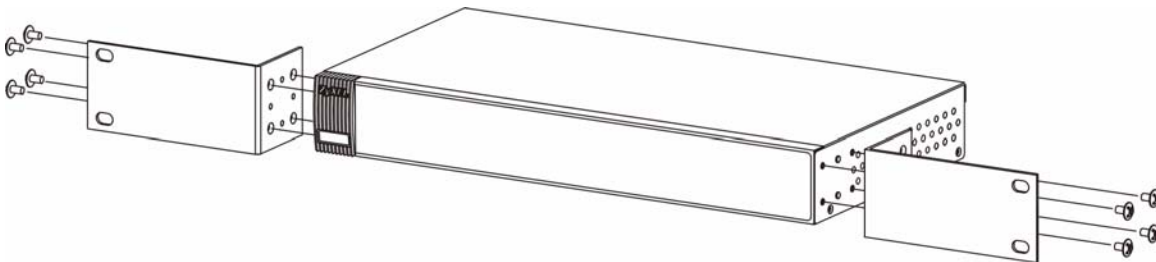

- 2 Using a #2 Philips screwdriver, install the M3 flat head screws through the mounting bracket holes into the switch.
- 3 Repeat steps 1 and 2 to install the second mounting bracket on the other side of the switch.
- 4 You may now mount the switch on a rack. Proceed to the next section.

2.2.3 Mounting the Switch on a Rack

- 1 Position a mounting bracket (that is already attached to the switch) on one side of the rack, lining up the two screw holes on the bracket with the screw holes on the side of the rack.

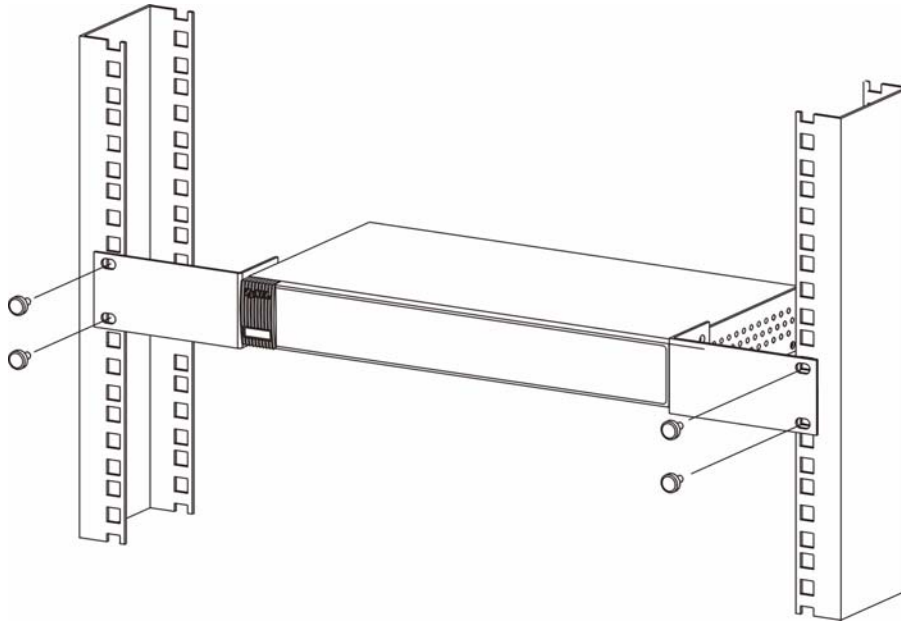
Figure 8 Mounting the Switch on a Rack

- 2** Using a #2 Philips screwdriver, install the M5 flat head screws through the mounting bracket holes into the rack.
- 3** Repeat steps **1** and **2** to attach the second mounting bracket on the other side of the rack.

2.3 Wall-mounting Installation

Do the following to hang your switch on a wall.

Note: See the product specifications appendix for the size of screws (not included) to use and how far apart to place them.

- 1** Locate a high position on wall that is free of obstructions. Use a sturdy wall.
- 2** Drill two holes for the screws (not included). Make sure the distance between the centers of the holes matches what is listed in the product specifications appendix.

Note: Be careful to avoid damaging pipes or cables located inside the wall when drilling holes for the screws.

- 3** Do not screw the screws all the way into the wall. Leave a small gap of about 0.5 cm between the heads of the screws and the wall.
- 4** Make sure the screws are snugly fastened to the wall. They need to hold the weight of the switch with the connection cables.
- 5** Align the holes on the back of the switch with the screws on the wall. Hang the switch on the screws.

CHAPTER 3

Hardware Overview

This chapter describes the front panel and rear panel of the switch and shows you how to make the hardware connections.

3.1 Front Panel Connection

The figure below shows the front panel of the switch.

Figure 9 Front Panel: ES-2108

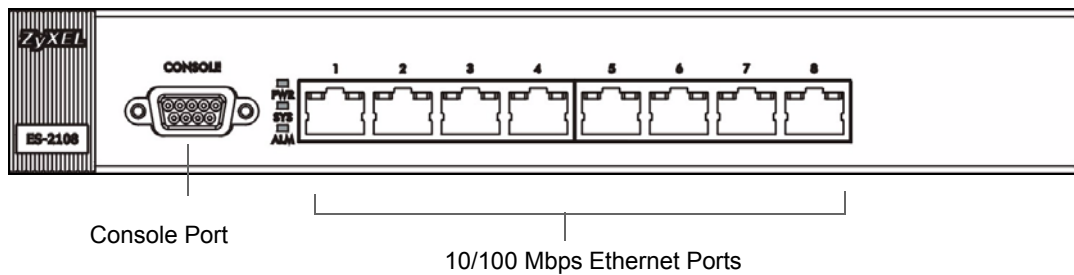

Figure 10 Front Panel: ES-2108-F

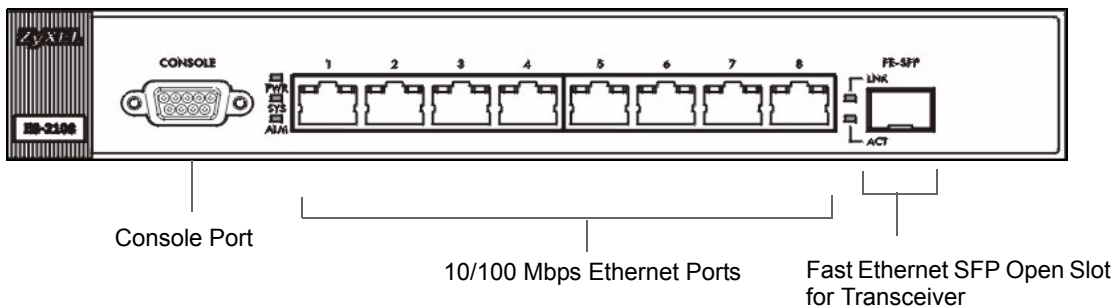

Figure 11 Front Panel: ES-2108-G/ES-2108PWR

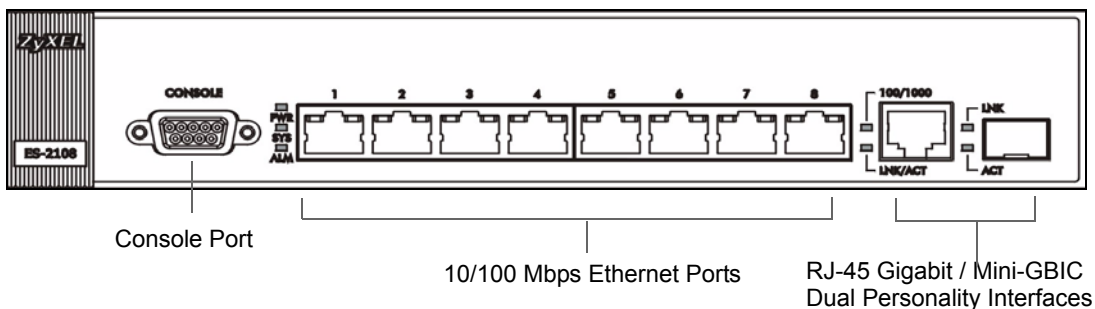
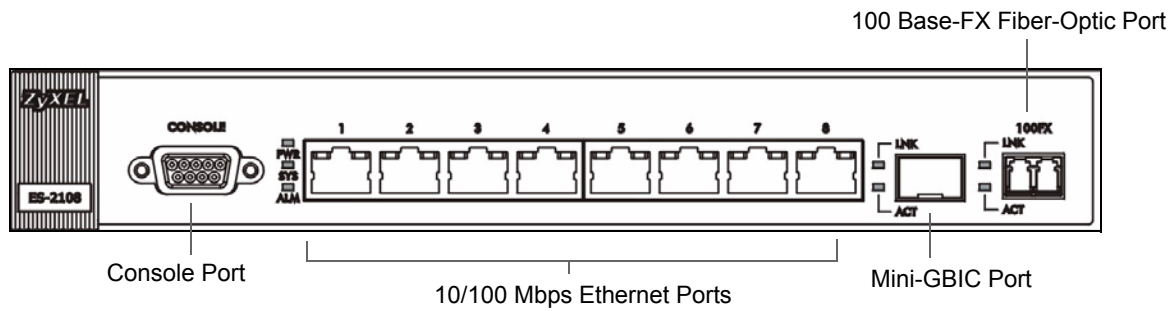

Figure 12 Front Panel: ES-2108-LC

The following table describes the port labels on the front panel.

Table 2 Front Panel

PORT	DESCRIPTION
All Models	
CONSOLE	Only connect this port if you want to configure the switch using the command line interface (CLI) via the console port.
Eight 10/100 Mbps RJ-45 Ethernet Ports	Connect these ports to a computer, a hub, an Ethernet switch or router.
ES-2108-F	
Fast Ethernet SFP Slot	Use a 100-Base FX, 100-Base LX or 100-Base BX Small Form-Factor Pluggable (SFP) transceiver in this slot for fiber-optic connections to backbone Ethernet switches.
ES-2108-LC	
Mini-GBIC Port	Use a mini-GBIC transceiver in this slot for fiber-optic connections to backbone Ethernet switches.
100 Base-FX Fiber-Optic Port	This is a 100-Base FX fiber-optic module and is only available on the ES-2108-LC. Use the fiber optic cable to connect this uplink port to a backbone Ethernet switch.
ES-2108-G / ES-2108PWR	
Dual Personality Interface	This interface has one 1000 Base-T copper RJ-45 port and one Small Form-Factor Pluggable (SFP) fiber port, with one port active at a time.
100/1000 Mbps RJ-45 Gigabit Port	Connect this Gigabit Ethernet port to high-bandwidth backbone network Ethernet switches.
Mini-GBIC Ports	Use mini-GBIC transceivers in these slots for fiber-optic connections to backbone Ethernet switches.
ES-2108PWR	
Power over Ethernet	The 8 10/100 Mbps RJ-45 Ethernet ports are compliant with the IEEE 802.3af power over Ethernet standard.

3.1.1 Console Port

For local management, you can use a computer with terminal emulation software configured to the following parameters:

- VT100 terminal emulation
- 9600 bps
- No parity, 8 data bits, 1 stop bit
- No flow control

Connect the male 9-pin end of the console cable to the console port of the switch. Connect the female end to a serial port (COM1, COM2 or other COM port) of your computer.

3.1.2 Ethernet Ports

The switch has Eight 10/100Mbps auto-negotiating, auto-crossover Ethernet ports. In 10/100Mbps Fast Ethernet, the speed can be 10Mbps or 100Mbps and the duplex mode can be half duplex or full duplex.

The ES-2108-G and ES-2108PWR also come with a Gigabit/mini-GBIC port each. The mini-GBIC port has priority over the Gigabit port. This means that if the mini-GBIC port and the corresponding Gigabit port are connected at the same time, the Gigabit port will be disabled. The speed of the Gigabit Ethernet/mini-GBIC port can be 100Mbps or 1000Mbps and the duplex mode can be half duplex (at 100 Mbps) or full duplex.

An auto-negotiating port can detect and adjust to the optimum Ethernet speed (10/100Mbps) and duplex mode (full duplex or half duplex) of the connected device.

An auto-crossover (auto-MDI/MDI-X) port automatically works with a straight-through or crossover Ethernet cable.

3.1.2.1 Default Ethernet Settings

The factory default negotiation settings for the Ethernet ports on the switch are:

- Speed: Auto
- Duplex: Auto
- Flow control: off

3.1.3 Fast Ethernet SFP Slot

The ES-2108-F comes with a slot for 100-Base FX, 100-Base LX or 100-Base BX Small Form-Factor Pluggable (SFP) transceivers. A transceiver is a single unit that houses a transmitter and a receiver. The switch does not come with transceivers. You must use transceivers that comply with the SFP Transceiver MultiSource Agreement (MSA). See the SFF committee's INF-8074i specification Rev 1.0 for details.

You can change transceivers while the switch is operating. You can use different transceivers to connect to Ethernet switches with different types of fiber-optic connectors.

- Type: SFP connection interface
- Connection speed: 100 Mbps

Note: To avoid possible eye injury, do not look into an operating fiber-optic module's connectors.

See [Section 3.1.4.1 on page 46](#) and [Section 3.1.4.2 on page 47](#) for transceiver installation and removal instructions.

3.1.4 Mini-GBIC Slot

This is a slot for mini-GBIC (Gigabit Interface Converter) transceivers. A transceiver is a single unit that houses a transmitter and a receiver. The switch does not come with transceivers. You must use transceivers that comply with the SFP Transceiver MultiSource Agreement (MSA). See the SFF committee's INF-8074i specification Rev 1.0 for details.

There is one Gigabit Ethernet and mini-GBIC port each. The mini-GBIC port has priority over the Gigabit port. This means that if the mini-GBIC port and the corresponding Gigabit port are connected at the same time, the Gigabit port will be disabled.

You can change transceivers while the switch is operating. You can use different transceivers to connect to Ethernet switches with different types of fiber-optic connectors.

- Type: SFP connection interface
- Connection speed: 1 Gigabit per second (Gbps)

Note: To avoid possible eye injury, do not look into an operating fiber-optic module's connectors.

3.1.4.1 Transceiver Installation

Use the following steps to install a mini GBIC transceiver (SFP module).

- 1 Insert the transceiver into the slot with the exposed section of PCB board facing down.

Figure 13 Transceiver Installation Example

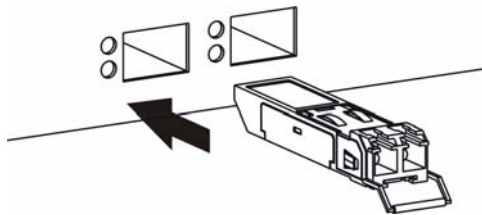

- 2 Press the transceiver firmly until it clicks into place.

- 3 The switch automatically detects the installed transceiver. Check the LEDs to verify that it is functioning properly.

Figure 14 Installed Transceiver

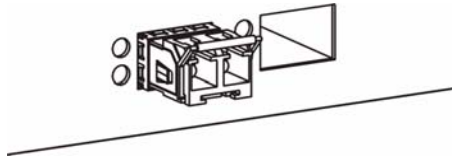

3.1.4.2 Transceiver Removal

Use the following steps to remove a mini GBIC transceiver (SFP module).

- 1 Open the transceiver's latch (latch styles vary).

Figure 15 Opening the Transceiver's Latch Example

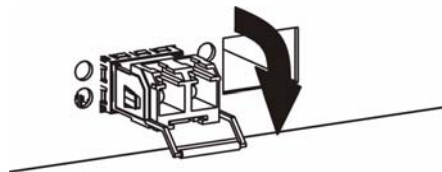

- 2 Pull the transceiver out of the slot.

Figure 16 Transceiver Removal Example

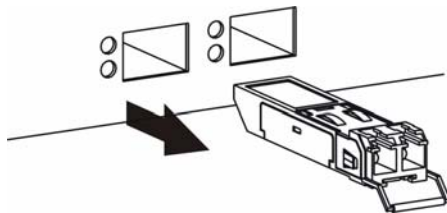

3.1.5 100 Base-FX Fiber-Optic Port

This 100 Base-FX fiber-optic port is only available on the ES-2108-LC.

Note: To avoid possible eye injury, do not look directly into a module's fiber-optic connectors. Keep the dust cover on a fiber-optic module until you connect it.

You may need to clean the fiber-optic cable's connectors with a cotton swab dipped in alcohol.

- Type: Fiber-optic
- Wavelength: 1310 +/- 50 nm
- Multi-mode
- Dual LC connectors
- Connection distance: Up to 2km

3.2 Rear Panel

The following figure shows the rear panel of the switch. The power receptacle is on the rear panel.

Figure 17 Rear Panel

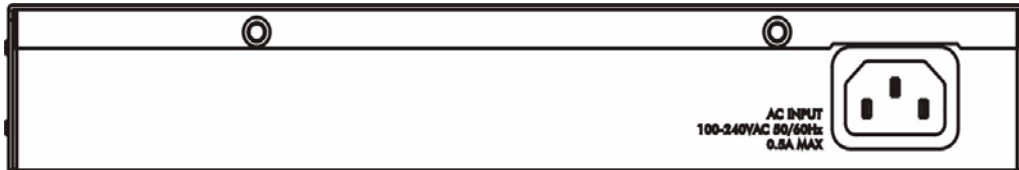

3.2.1 Power Connector

Make sure you are using the correct power source as shown on the panel.

To connect the power to the switch, insert the female end of power cord to the power receptacle on the rear panel. Connect the other end of the supplied power cord to the power source. Make sure that no objects obstruct the airflow of the fans.

3.3 LEDs

The following table describes the LEDs.

Table 3 LEDs

LED	COLOR	STATUS	DESCRIPTION
PWR	Green	On	The system is turned on.
		Off	The system is off.
SYS	Green	Blinking	The system is rebooting and performing self-diagnostic tests.
		On	The system is on and functioning properly.
		Off	The power is off or the system is not ready/malfunctioning.
ALM	Red	On	There is a hardware failure.
		Off	The system is functioning normally.
1 - 8 (Ethernet ports) (ES-2108, ES-2108-F, ES-2108-G and ES-2108-LC)	Green	Blinking	The system is transmitting/receiving to/from a 10 Mbps Ethernet network.
		On	The link to a 10 Mbps Ethernet network is up.
	Amber	Blinking	The system is transmitting/receiving to/from a 100 Mbps Ethernet network.
		On	The link to a 100 Mbps Ethernet network is up.
		Off	The link to an Ethernet network is down.

Table 3 LEDs (continued)

LED	COLOR	STATUS	DESCRIPTION
1 - 8 (Ethernet ports) (ES-2108PWR only)	Green	On	The switch is supplying power to the connected device that supports PoE.
		Off	No device is connected to this port or the switch is not supplying power via the Ethernet cable.
	Amber	Blinking	The system is transmitting/receiving to/from a 10/100 Mbps Ethernet network.
		On	The link to a 10/100 Mbps Ethernet network is up.
		Off	The link to an Ethernet network is down.
100/1000	Green	On	The link to a 1000 Mbps Ethernet network is up.
	Amber	On	The link to a 100 Mbps Ethernet network is up.
		Off	The link to an Ethernet network is down.
LNK/ACT	Green	Blinking	The port is receiving or transmitting data.
		On	The port has a connection to an Ethernet network but not receiving or transmitting data.
		Off	The link to an Ethernet network is down.
LNK (mini-GBIC or Fast Ethernet SFP Slot)	Green	On	The port has a successful connection.
		Off	No Ethernet device is connected to this port.
ACT (mini-GBIC or Fast Ethernet SFP Slot)	Green	Blinking	The port is sending or receiving data.
		Off	The port is not sending or receiving data.
LNK (100 FX)	Green	On	The port has a successful connection.
		Off	No Ethernet device is connected to this port.
ACT (100 FX)	Green	Blinking	The port is sending or receiving data.
		Off	The port is not sending or receiving data.

CHAPTER 4

The Web Configurator

This section introduces the configuration and functions of the web configurator. This guide uses the ES-2108PWR screenshots as an example. The screens may vary slightly for different ES-2108 models. Not all fields are available on all models.

4.1 Introduction

The web configurator is an HTML-based management interface that allows easy switch setup and management via Internet browser. Use Internet Explorer 6.0 and later or Netscape Navigator 7.0 and later versions. The recommended screen resolution is 1024 by 768 pixels.

In order to use the web configurator you need to allow:

- Web browser pop-up windows from your device. Web pop-up blocking is enabled by default in Windows XP SP (Service Pack) 2.
- Java Script (enabled by default).
- Java permissions (enabled by default).

4.2 System Login

- 1 Start your web browser.
- 2 Type “http://” and the IP address of the switch (for example, the default is 192.168.1.1) in the Location or Address field. Press [ENTER].
- 3 The login screen appears. The default username is **admin** and associated default password is **1234**. The date and time display as shown if you have not configured a time server nor manually entered a time and date in the **General Setup** screen.

Figure 18 Web Configurator: Login

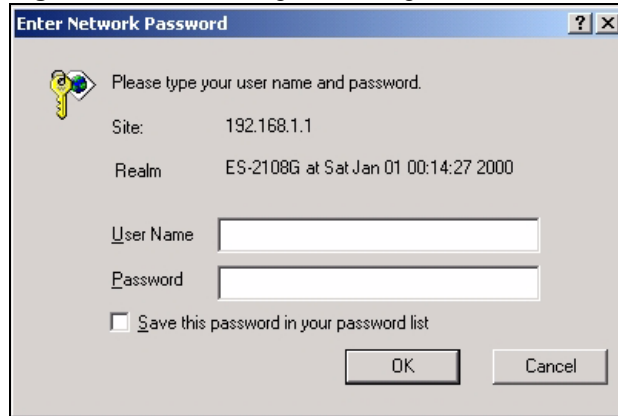

4 Click **OK** to view the first web configurator screen.

4.3 The Status Screen

The **Status** screen is the first screen that displays when you access the web configurator.

The following figure shows the navigating components of a web configurator screen.

Figure 19 Web Configurator Home Screen (Status)



A - Click the menu items to open submenu links, and then click on a submenu link to open the screen in the main window.

B, C, D, E - These are quick links which allow you to perform certain tasks no matter which screen you are currently working in.

B - Click this link to save your configuration into the switch's nonvolatile memory. Nonvolatile memory is the configuration of your switch that stays the same even if the switch's power is turned off.





C - Click this link to go to the status page of the switch.

D - Click this link to logout of the web configurator.

E - Click this link to display web help pages. The help pages provide descriptions for all of the configuration screens.

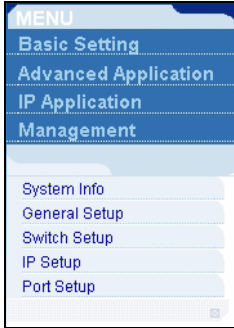
In the navigation panel, click a main link to reveal a list of submenu links.

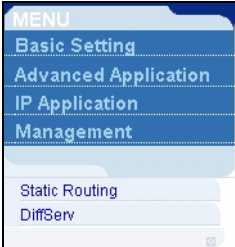
Table 4 Navigation Panel Sub-links Overview

BASIC SETTING	ADVANCED APPLICATION	IP APPLICATION	MANAGEMENT
			

The following table lists the various web configurator screens within the sub-links.

Table 5 Web Configurator Screen Sub-links Details

BASIC SETTING	ADVANCED APPLICATION	IP APPLICATION	MANAGEMENT
System Info General Setup Switch Setup IP Setup Port Setup	VLAN VLAN Status VLAN Port Setting Static VLAN Static MAC Forwarding Filtering Spanning Tree Protocol Status Spanning Tree Protocol Configuration Bandwidth Control Broadcast Storm Control Mirroring Link Aggregation Link Aggregation Control Protocol Status Configuration Port Authentication RADIUS 802.1x Port Security Queuing Method Multicast Multicast Status Multicast Setting IGMP Filtering Profile MVR Group Configuration	Static Routing DiffServ DSCP Setting	Maintenance Firmware Upgrade Restore Configuration Backup Configuration Load Factory Default Save Configuration Reboot System Access Control SNMP Logins Service Access Control Remote Management Diagnostic Syslog Setup Server Setup Cluster Management Status Configuration MAC Table ARP Table Configure Clone

The following table describes the links in the navigation panel.

Table 6 Navigation Panel Links

LINK	DESCRIPTION
Basic Settings	
System Info	This link takes you to a screen that displays general system and hardware monitoring information (on the ES-2108PWR).
General Setup	This link takes you to a screen where you can configure general identification information about the switch.

Table 6 Navigation Panel Links (continued)

LINK	DESCRIPTION
Switch Setup	This link takes you to a screen where you can set up global switch parameters such as VLAN type, MAC address learning, GARP and priority queues.
IP Setup	This link takes you to a screen where you can configure the management IP address, subnet mask (necessary for switch management) and DNS (domain name server).
Port Setup	This link takes you to screens where you can configure settings for individual switch ports.
Advanced Application	
VLAN	This link takes you to screens where you can configure port-based or 802.1Q VLAN (depending on what you configured in the Switch Setup menu).
Static MAC Forwarding	This link takes you to screens where you can configure static MAC addresses for a port. These static MAC addresses do not age out.
Filtering	This link takes you to a screen to set up filtering rules.
Spanning Tree Protocol	This link takes you to screens where you can configure the STP/RSTP to prevent network loops.
Bandwidth Control	This link takes you to screens where you can cap the maximum bandwidth allowed from specified source(s) to specified destination(s).
Broadcast Storm Control	This link takes you to a screen to set up broadcast filters.
Mirroring	This link takes you to screens where you can copy traffic from one port or ports to another port in order that you can examine the traffic from the first port without interference
Link Aggregation	This link takes you to a screen where you can logically aggregate physical links to form one logical, higher-bandwidth link.
Port Authentication	This link takes you to a screen where you can configure RADIUS (Remote Authentication Dial-In User Service), a protocol for user authentication that allows you to use an external server to validate an unlimited number of users.
Port Security	This link takes you to a screen where you can activate MAC address learning and set the maximum number of MAC addresses to learn on a port.
Queuing Method	This link takes you to a screen where you can configure SPQ or WRR with associated queue weights for each port.
Multicast	This link takes you to a screen where you can configure multicast settings, IGMP filters and multicast VLAN groups.
IP Application	
Static Route	This link takes you to screens where you can configure static routes. A static route defines how the switch should forward traffic by configuring the TCP/IP parameters manually.
DiffServ	This link takes you to screens where you can enable DiffServ and set DSCP-to-IEEE802.1p mappings.
Advanced Management	
Maintenance	This link takes you to screens where you can perform firmware and configuration file maintenance as well as reboot the system.
Access Control	This link takes you to screens where you can change the system login password and configure SNMP and remote management.
Diagnostic	This link takes you to screens where you can view system logs and test port(s).

Table 6 Navigation Panel Links (continued)

LINK	DESCRIPTION
Syslog	This link takes you to screens where you can setup system logs and a system log server.
Cluster Management	This link takes you to a screen where you can configure clustering management and view its status.
MAC Table	This link takes you to a screen where you can view the MAC addresses (and types) of devices attached to what ports and VLAN IDs.
ARP Table	This link takes you to a screen where you can view the MAC addresses – IP address resolution table.
Configure Clone	This link takes you to a screen where you can clone port attributes of a port and transfer them to other port(s).

4.3.1 Change Your Password

After you log in for the first time, it is recommended you change the default administrator password. Click **Management**, **Access Control** and then **Logins** to display the next screen.

Figure 20 Change Administrator Login Password

The screenshot shows the 'Logins' configuration page. At the top, there are tabs for 'Logins' (selected) and 'Access Control'. Below the tabs, the 'Administrator' section is highlighted. It contains three input fields: 'Old Password', 'New Password', and 'Retype to confirm'. A red box highlights these three fields. Below the input fields, there is a warning message: 'Please record your new password whenever you change it. The system will lock you out if you have forgotten your password.' Below the warning, there is a section titled 'Edit Logins' which contains a table with four columns: 'Login', 'User Name', 'Password', and 'Retype to confirm'. The table has four rows, numbered 1 to 4. At the bottom of the page, there are 'Apply' and 'Cancel' buttons.

Old Password	New Password	Retype to confirm
<input type="text"/>	<input type="text"/>	<input type="text"/>

Please record your new password whenever you change it. The system will lock you out if you have forgotten your password.

Login	User Name	Password	Retype to confirm
1	<input type="text"/>	<input type="text"/>	<input type="text"/>
2	<input type="text"/>	<input type="text"/>	<input type="text"/>
3	<input type="text"/>	<input type="text"/>	<input type="text"/>
4	<input type="text"/>	<input type="text"/>	<input type="text"/>

Apply Cancel

4.4 Saving Your Configuration

When you are done modifying the settings in a screen, click **Apply** to save your changes back to the run-time memory. Settings in the run-time memory are lost when the switch's power is turned off.

Click the **Save** link in the upper right hand corner of the web configurator to save your configuration to nonvolatile memory. Nonvolatile memory refers to the switch's storage that remains even if the switch's power is turned off.

Note: Use the **Save** link when you are done with a configuration session.

4.5 Switch Lockout

You could block yourself (and all others) from accessing the switch through the web configurator if you do one of the following:

- 1 Deleting the management VLAN (default is VLAN 1).
- 2 Deleting all port-based VLANs with the CPU port as a member. The "CPU port" is the management port of the switch.
- 3 Filtering all traffic to the CPU port.
- 4 Disabling all ports.
- 5 Assigning minimum bandwidth to the CPU port. If you limit bandwidth to the CPU port, you may find that the switch performs sluggishly or not at all.

Note: Be careful not to lock yourself and others out of the switch.

4.6 Resetting the Switch

If you lock yourself (and others) from the switch or forget the switch password, you will need to reload the factory-default configuration file or reset the switch back to the factory defaults.

4.6.1 Reload the Factory-default Configuration File

Uploading the factory-default configuration file replaces the current configuration file with the factory-default configuration file. This means that you will lose all previous configurations and the speed of the console port will be reset to the default of 9600bps with 8 data bit, no parity, one stop bit and flow control set to none. The password will also be reset to "1234" and the IP address to 192.168.1.1.

To upload the factory-default configuration file, do the following:

- 1 Connect to the console port using a computer with terminal emulation software. See [Section 3.1.1 on page 45](#) for details.
- 2 Disconnect and reconnect the switch's power to begin a session. When you reconnect the switch's power, you will see the initial screen.
- 3 When you see the message "Press any key to enter Debug Mode within 3 seconds..." press any key to enter debug mode.

- 4 Type `atlc` after the “Enter Debug Mode” message.
- 5 Wait for the “Starting XMODEM upload” message before activating XMODEM upload on your terminal.
- 6 After the factory-default configuration file upload, type `atgo` to restart the switch.

Figure 21 Resetting the Switch: Via the Console Port

```

Bootbase Version: V1.01 | 01/05/2006 09:19:25
RAM: Size = 32768 Kbytes
DRAM POST: Testing: 32768K   OK
FLASH: AMD 32M *1
ZyNOS Version: V3.70 (ABS.0)b0 | 05/10/2006 18:35:35
Press any key to enter debug mode within 3 seconds.
.....
Enter Debug Mode
ras> atlc
Starting XMODEM upload (CRC mode)....
CCCCCCCCCCCCCCCC
Total 262144 bytes received.
Erasing..
.....
OK
ras> atgo

```

The switch is now re initialized with the factory-default configuration file including the default password of “1234”.

4.7 Logging Out of the Web Configurator

Click **Logout** in a screen to exit the web configurator. You have to log in with your password again after you log out. This is recommended after you finish a management session both for security reasons and so as you don't lock out other switch administrators.

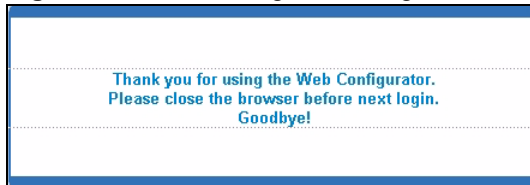
Figure 22 Web Configurator: Logout Screen

4.8 Help

The web configurator's online help has descriptions of individual screens and some supplementary information.

Click the **Help** link from a web configurator screen to view an online help description of that screen.

CHAPTER 5

Initial Setup Example

This chapter shows how to set up the switch for an example network.

5.1 Overview

The following lists the configuration steps for the initial setup:

- Create a VLAN
- Set port VLAN ID
- Configure the switch IP management address

5.1.1 Creating a VLAN

VLANs confine broadcast frames to the VLAN group in which the port(s) belongs. You can do this with port-based VLAN or tagged static VLAN with fixed port members.

In this example, you want to configure port 5 as a member of VLAN 2.

Figure 23 Initial Setup Network Example: VLAN

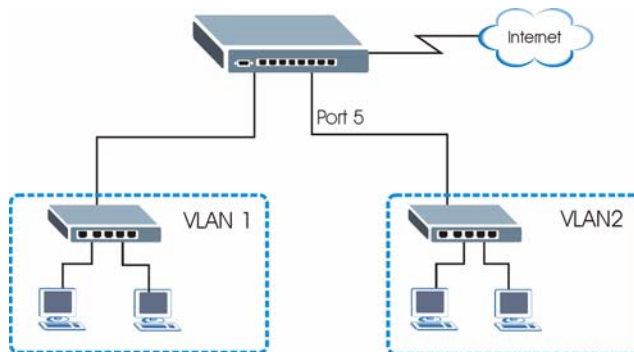

- 1 Click **Advanced Application** and **VLAN** in the navigation panel and click the **Static VLAN** link.

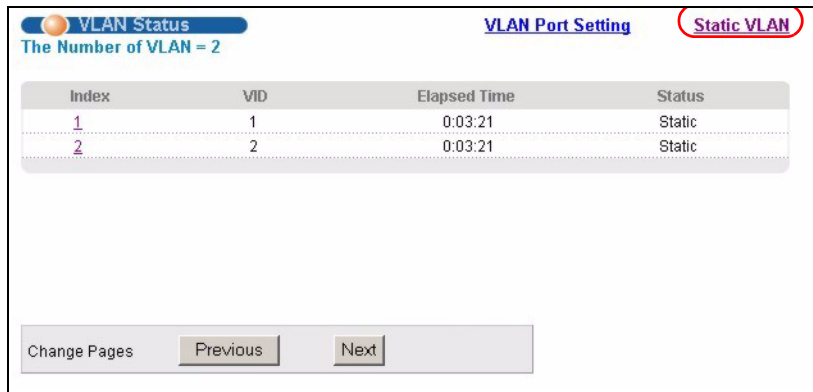

- 2 In the **Static VLAN** screen, select **ACTIVE**, enter a descriptive name in the **Name** field and enter 2 in the **VLAN Group ID** field for the **VLAN2** network.

Note: The **VLAN Group ID** field in this screen and the **VID** field in the **IP Setup** screen refer to the same VLAN ID.

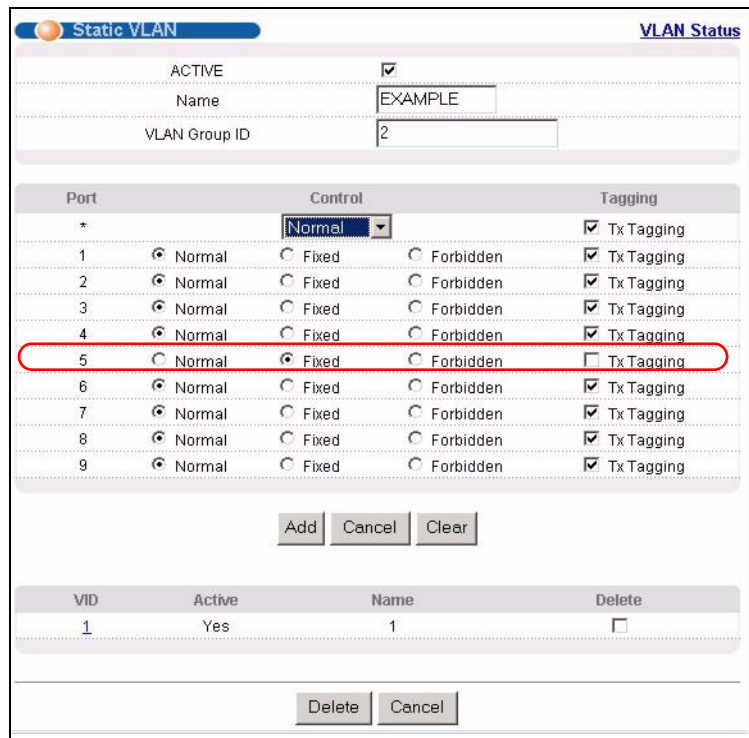

- 3 Since the **VLAN2** network is connected to port 5 on the switch, select **Fixed** to configure port 5 to be a permanent member of the VLAN only.

- 4 To ensure that VLAN-unaware devices (such as computers and hubs) can receive frames properly, clear the **TX Tagging** check box to set the switch to remove VLAN tags before sending.

- 5 Click **Add** to save the settings to the run-time memory. Settings in the run-time memory are lost when the switch's power is turned off.

5.1.2 Setting Port VID

Use PVID to add a tag to incoming untagged frames received on that port so that the frames are forwarded to the VLAN group that the tag defines.

In the example network, configure 2 as the port VID on port 5 so that any untagged frames received on that port get sent to VLAN 2.

Figure 24 Initial Setup Network Example: Port VID

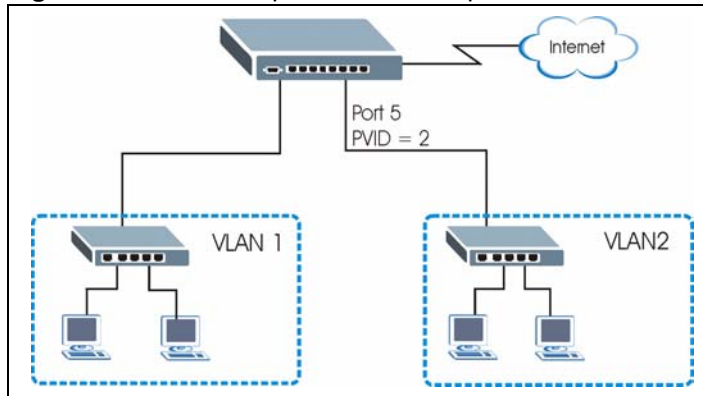

1 Click **Advanced Applications** and **VLAN** in the navigation panel. Then click the **VLAN Port Setting** link.

2 Enter 2 in the **PVID** field for port 5 and click **Apply** to save your changes back to the run-time memory. Settings in the run-time memory are lost when the switch's power is turned off.

VLAN Port Setting VLAN Status

GVRP

Port Isolation

Ingress Check

Port	PVID	GVRP	Acceptable Frame Type	VLAN Trunking
*		<input type="checkbox"/>	All	<input type="checkbox"/>
1	1	<input type="checkbox"/>	All	<input type="checkbox"/>
2	1	<input type="checkbox"/>	All	<input type="checkbox"/>
3	1	<input type="checkbox"/>	All	<input type="checkbox"/>
4	1	<input type="checkbox"/>	All	<input type="checkbox"/>
5	2	<input type="checkbox"/>	All	<input type="checkbox"/>
6	1	<input type="checkbox"/>	All	<input type="checkbox"/>
7	1	<input type="checkbox"/>	All	<input type="checkbox"/>
8	1	<input type="checkbox"/>	All	<input type="checkbox"/>
9	1	<input type="checkbox"/>	All	<input type="checkbox"/>

Apply Cancel

5.1.3 Configuring Switch Management IP Address

The default management IP address of the switch is 192.168.1.1. You can configure another IP address in a different subnet for management purposes. The following figure shows an example.

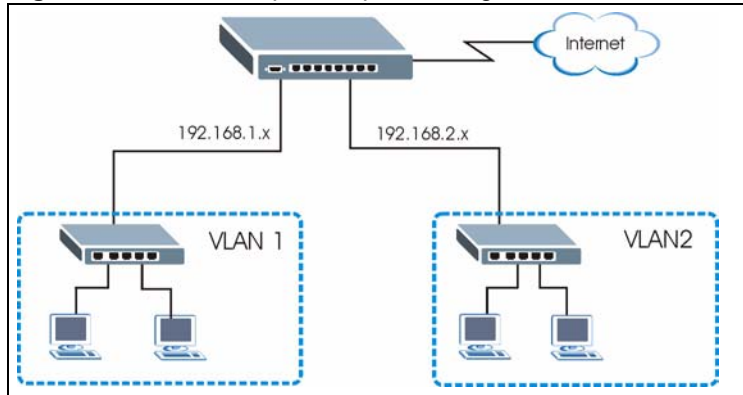
Figure 25 Initial Setup Example: Management IP Address

- 1 Connect your computer to any Ethernet port on the switch. Make sure your computer is in the same subnet as the switch.
- 2 Open your web browser and enter 192.168.1.1 (the default IP address) in the address bar to access the web configurator. See [Section 4.2 on page 51](#) for more information.

3 Click **Basic Setting** and **IP Setup** in the navigation panel.

4 Configure the related fields in the **IP Setup** screen.

For the **VLAN2** network, enter 192.168.2.1 as the IP address and 255.255.255.0 as the subnet mask.

5 In the **VID** field, enter the ID of the VLAN group to which you want this management IP address to belong. This is the same as the VLAN ID you configure in the **Static VLAN** screen.

6 Click **Add** to save your changes back to the run-time memory. Settings in the run-time memory are lost when the switch's power is turned off.

The screenshot shows the IP Setup configuration page. The 'Default Management IP Address' section has 'Static IP Address' selected. The fields are: IP Address: 192.168.1.1, IP Subnet Mask: 255.255.255.0, Default Gateway: 0.0.0.0, and VID: 1. Below this is the 'Management IP Addresses' table, which has a red circle around a new entry: IP Address: 192.168.2.1, IP Subnet Mask: 255.255.255.0, VID: 2, and Default Gateway: 192.168.2.1. The table has columns for Index, IP Address, IP Subnet Mask, VID, Default Gateway, and Delete.

Index	IP Address	IP Subnet Mask	VID	Default Gateway	Delete
	192.168.2.1	255.255.255.0	2	192.168.2.1	

CHAPTER 6

System Status and Port Statistics

This chapter describes the system status (web configurator home page) and port details screens.

6.1 Port Status Overview

The home screen of the web configurator displays a port statistical summary table with links to each port showing statistical details.

To view the port statistics, click **Status** in all web configurator screens to display the **Status** screen as shown next.

Note: The ES-2108PWR screen is different from the other models covered in this UG. The screen from ES-2108-G model is shown for comparison.

Figure 26 Status (ES-2108PWR)

Port	Name	Link	State	PD	LACP	TxPkts	RxPkts	Errors	Tx KB/s	Rx KB/s	Up Time
1	""	100M/F	FORWARDING	Off	Disabled	341	480	0	0.0	0.0	0:13:55
2	""	Down	STOP	Off	Disabled	0	0	0	0.0	0.0	0:00:00
3	""	Down	STOP	Off	Disabled	0	0	0	0.0	0.0	0:00:00
4	""	Down	STOP	Off	Disabled	0	0	0	0.0	0.0	0:00:00
5	""	Down	STOP	Off	Disabled	0	0	0	0.0	0.0	0:00:00
6	""	Down	STOP	Off	Disabled	0	0	0	0.0	0.0	0:00:00
7	""	Down	STOP	Off	Disabled	0	0	0	0.0	0.0	0:00:00
8	""	Down	STOP	Off	Disabled	0	0	0	0.0	0.0	0:00:00
9	""	Down	STOP	-	Disabled	0	0	0	0.0	0.0	0:00:00

Any
 Port

Figure 27 Status (ES-2108-G)

Port Status											
Port	Name	Link	State	LACP	TxPkts	RxPkts	Errors	Tx KB/s	Rx KB/s	Up Time	
1	""	Down	STOP	Disabled	0	0	0	0.0	0.0	0:00:00	
2	""	Down	STOP	Disabled	0	0	0	0.0	0.0	0:00:00	
3	""	Down	STOP	Disabled	0	0	0	0.0	0.0	0:00:00	
4	""	Down	STOP	Disabled	0	0	0	0.0	0.0	0:00:00	
5	""	100M/F	FORWARDING	Disabled	252	325	0	0.338	0.501	0:03:36	
6	""	Down	STOP	Disabled	0	0	0	0.0	0.0	0:00:00	
7	""	Down	STOP	Disabled	0	0	0	0.0	0.0	0:00:00	
8	""	Down	STOP	Disabled	0	0	0	0.0	0.0	0:00:00	
9	""	100M/F Copper	FORWARDING	Disabled	335	8	0	6.869	0.0	0:03:34	

Any
 Port

The following table describes the labels in this screen.

Table 7 Status

LABEL	DESCRIPTION
Port	This identifies the Ethernet port. Click a port number to display the Port Details screen (refer to Figure 28 on page 66).
Name	This field displays the name of the port.
Link	This field displays the speed (either 10M for 10Mbps, 100M for 100Mbps or another value depending on the uplink module being used) and the duplex (F for full duplex or H for half duplex).
State	If STP (Spanning Tree Protocol) is enabled, this field displays the STP state of the port (see Section 11.1.3 on page 102 for more information). If STP is disabled, this field displays FORWARDING if the link is up, otherwise, it displays STOP.
PD (ES-2108PWR Only)	This fields displays whether PoE (Power over Ethernet) is enabled (On) or disabled (Off) on this port.
LACP	This fields displays whether LACP (Link Aggregation Control Protocol) has been enabled on the port.
TxPkts	This field shows the number of transmitted frames on this port.
RxPkts	This field shows the number of received frames on this port.
Errors	This field shows the number of received errors on this port.
Tx KB/s	This field shows the number of kilobytes per second transmitted on this port.
Rx KB/s	This field shows the number of kilobytes per second received on this port.
Up Time	This field shows the total amount of time in hours, minutes and seconds the port has been up.
Clear Counter	Select Port and type a port number or select Any to select all ports then click Clear Counter to erase the recorded statistical information for a port or all ports.

6.1.1 Status: Port Details

Click a number in the **Port** column in the **Status** screen to display individual port statistics. Use this screen to check status and detailed performance data about an individual port on the switch.

Note: The ES-2108PWR screen is different from the other models covered in this UG. The screen from ES-2108-G model is shown for comparison.

Figure 28 Status: Port Details (ES-2108PWR)

Port Details		Port Status
Port Info	Port NO.	1
	Name	""
	Link	100M/F
	Status	FORWARDING
	PD PowerConsumption (mW)	0
	PD MaxCurrent (mA)	0.0
	PD MaxPower (mW)	0
	LACP	Disabled
	TxPkts	372
	RxPkts	550
	Errors	0
	Tx KBs/s	0.0
	Rx KBs/s	0.0
	Up Time	0:25:49
TX Packet	TX Packets	372
	Multicast	0
	Broadcast	2
	Pause	0
RX Packet	RX Packets	550
	Multicast	0
	Broadcast	207
	Pause	0
TX Collision	Single	0
	Multiple	0
	Excessive	0
	Late	0
Error Packet	RX CRC	0
	Runt	0
Distribution	64	30
	65 to 127	67
	128 to 255	6
	256 to 511	14
	512 to 1023	8
	1024 to 1518	0
	Giant	0

Figure 29 Status: Port Details (ES-2108-G)

Port Details		Port Status
Port Info	Port NO.	1
	Name	Port1
	Link	Down
	Status	FORWARDING
	LACP	Disabled
	TxPkts	106
	RxPkts	125
	Errors	0
	Tx KBs/s	0.0
	Rx KBs/s	0.0
	Up Time	0:21:01
TX Packet	TX Packets	106
	Multicast	0
	Broadcast	106
	Pause	0
RX Packet	RX Packets	125
	Multicast	2
	Broadcast	118
	Pause	0
TX Collision	Single	0
	Multiple	0
	Excessive	0
	Late	0
Error Packet	RX CRC	0
	Runt	0
Distribution	64	30
	65 to 127	67
	128 to 255	6
	256 to 511	14
	512 to 1023	8
	1024 to 1518	0
	Giant	0

The following table describes the labels in this screen.

Table 8 Status: Port Details

LABEL	DESCRIPTION
Port Info	
Name	This field shows the name of the port.
Link	This field shows whether the Ethernet connection is down, and the speed/duplex mode.
Status	If STP (Spanning Tree Protocol) is enabled, this field displays the STP state of the port (see Section 11.1.3 on page 102 for more information). If STP is disabled, this field displays FORWARDING if the link is up, otherwise, it displays STOP.
PD PowerConsumption (W) (ES-2108PWR Only)	This field is only available on the ES-2108PWR but not available for the Gigabit and mini-GBIC ports. This field shows the power consumption of the powered device connected to the port.

Table 8 Status: Port Details (continued)

LABEL	DESCRIPTION
PD MaxCurrent (mA) (ES-2108PWR Only)	<p>This field is only available on the ES-2108PWR but not available for the Gigabit and mini-GBIC ports.</p> <p>This field shows the maximum current a powered device can get from the switch. If the powered device's power consumption exceeds the maximum power offered by the switch, the switch stops sending power.</p> <p>The switch can provide up to 351.36mA current to one PD connected to each 10/100Mbps Ethernet port and up to a total of 123.2W power to all PDs connected to the switch.</p>
PD MaxPower (mW) (ES-2108PWR Only)	This field shows the maximum power the switch can provide through this port.
LACP	This field shows if LACP is enabled on this port or not.
TxPkts	This field shows the number of transmitted frames on this port
RxPkts	This field shows the number of received frames on this port
Errors	This field shows the number of received errors on this port.
Tx KB/s	This field shows the number kilobytes per second transmitted on this port.
Rx KB/s	This field shows the number of kilobytes per second received on this port.
Up Time	This field shows the total amount of time the connection has been up.
Tx Packet The following fields display detailed information about packets transmitted.	
TX Packets	This field shows the number of good packets (unicast, multicast and broadcast) transmitted.
Multicast	This field shows the number of good multicast packets transmitted.
Broadcast	This field shows the number of good broadcast packets transmitted.
Pause	This field shows the number of 802.3x Pause packets transmitted.
Rx Packet The following fields display detailed information about packets received.	
RX Packets	This field shows the number of good packets (unicast, multicast and broadcast) received.
Multicast	This field shows the number of good multicast packets received.
Broadcast	This field shows the number of good broadcast packets received.
Pause	This field shows the number of 802.3x Pause packets received.
TX Collision The following fields display information on collisions while transmitting.	
Single	This is a count of successfully transmitted packets for which transmission is inhibited by exactly one collision.
Multiple	This is a count of successfully transmitted packets for which transmission was inhibited by more than one collision.
Excessive	This is a count of packets for which transmission failed due to excessive collisions. Excessive collision is defined as the number of maximum collisions before the retransmission count is reset.
Late	This is the number of times a late collision is detected, that is, after 512 bits of the packets have already been transmitted.

Table 8 Status: Port Details (continued)

LABEL	DESCRIPTION
Error Packet	
RX CRC	This field shows the number of packets received with CRC (Cyclic Redundant Check) error(s).
Runt	This field shows the number of packets received that were too short (shorter than 64 octets), including the ones with CRC errors.
Distribution	
64	This field shows the number of packets (including bad packets) received that were 64 octets in length.
65-127	This field shows the number of packets (including bad packets) received that were between 65 and 127 octets in length.
128-255	This field shows the number of packets (including bad packets) received that were between 128 and 255 octets in length.
256-511	This field shows the number of packets (including bad packets) received that were between 256 and 511 octets in length.
512-1023	This field shows the number of packets (including bad packets) received that were between 512 and 1023 octets in length.
1024-1518	This field shows the number of packets (including bad packets) received that were between 1024 and 1518 octets in length.
Giant	This field shows the number of packets dropped because they were bigger than the maximum frame size.

CHAPTER 7

Basic Setting

This chapter describes how to configure the **System Info**, **General Setup**, **Switch Setup**, **IP Setup** and **Port Setup** screens.

7.1 Overview

The **System Info** screen displays general switch information (such as firmware version number) and hardware polling information (such as fan speeds). The **General Setup** screen allows you to configure general switch identification information. The **General Setup** screen also allows you to set the system time manually or get the current time and date from an external server when you turn on your switch. The real time is then displayed in the switch logs. The **Switch Setup** screen allows you to set up and configure global switch features. The **IP Setup** screen allows you to configure a switch IP address, subnet mask(s) and DNS (domain name server) for management purposes.

7.2 System Information

In the navigation panel, click **Basic Setting** and **System Info** to display the screen as shown. You can check the firmware version number and monitor the switch temperature, fan speeds and voltage (on the ES-2108PWR) in this screen.

Note: The ES-2108PWR screen is different from the other models covered in this UG. The screen from ES-2108-G model is shown for comparison.

Figure 30 System Info (ES-2108PWR)

System Info					
System Name		ES-2108PWR			
ZyNOS FW Version		V3.70(ABS.0)b0 06/14/2006			
Ethernet Address		00:13:49:00:00:01			
PoE Status					
Total Power (W)		200.0			
Consuming Power (W)		0.0			
Remaining Power (W)		200.0			
Hardware Monitor					
Temperature Unit <input type="button" value="C"/>					
Temperature (C)	Current	MAX	MIN	Threshold	Status
CPU	40.0	40.0	38.0	75.0	Normal
MAC	35.0	35.0	33.0	65.0	Normal
LOCAL	35.0	35.0	34.0	65.0	Normal
FAN Speed (RPM)	Current	MAX	MIN	Threshold	Status
FAN1	6467	6467	6293	0	Normal
Voltage (V)	Current	MAX	MIN	Threshold	Status
1.25VIN	1.243	1.243	1.243	+/-6%	Normal
1.8VIN	1.834	1.834	1.820	+/-6%	Normal
3.3VIN	3.311	3.311	3.253	+/-6%	Normal
2.5VIN	2.576	2.576	2.576	+/-6%	Normal

Figure 31 System Info (ES-2108-G)

System Info	
System Name	ES-2108G
ZyNOS FW Version	V3.60(ABL.0)b0 06/27/2005
Ethernet Address	00:13:49:00:00:01

The following table describes the labels in this screen.

Table 9 System Info

LABEL	DESCRIPTION
System Name	This field displays the descriptive name of the switch for identification purposes.
ZyNOS FW Version	This field displays the version number of the switch 's current firmware including the date created.
Ethernet Address	This field refers to the Ethernet MAC (Media Access Control) address of the switch.
PoE Status (This section is only available on the ES-2108PWR model)	
Total Power (W)	This is the total power in Watts the ES-2108PWR can provide over the Ethernet.
Consuming Power (W)	This is the power consumed by PoE compatible devices connected to the ES-2108PWR.
Remaining Power (W)	This is the remaining power in Watts the ES-2108PWR can provide over the Ethernet.

Table 9 System Info (continued)

LABEL	DESCRIPTION
Hardware Monitor (The following hardware monitoring information is only available on the ES-2108PWR.)	
Temperature Unit	The switch has temperature sensors that are capable of detecting and reporting if the temperature rises above the threshold. You may choose the temperature unit (Centigrade or Fahrenheit) in this field.
Temperature	CPU, MAC and LOCAL refer to the location of the temperature sensors on the switch printed circuit board.
Current	This field displays the current temperature measured at this sensor.
MAX	This field displays the maximum temperature measured at this sensor.
MIN	This field displays the minimum temperature measured at this sensor.
Threshold	This field displays the upper temperature limit at this sensor.
Status	This field displays Normal for temperatures below the threshold and Error for those above.
Fan speed (RPM)	A properly functioning fan is an essential component (along with a sufficiently ventilated, cool operating environment) in order for the device to stay within the temperature threshold. Each fan has a sensor that is capable of detecting and reporting if the fan speed falls below the threshold shown.
Current	This field displays this fan's current speed in Revolutions Per Minute (RPM).
MAX	This field displays this fan's maximum speed measured in Revolutions Per Minute (RPM).
MIN	This field displays this fan's minimum speed measured in Revolutions Per Minute (RPM). "<41" is displayed for speeds too small to measure (under 2000 RPM).
Threshold	This field displays the minimum speed at which a normal fan should work.
Status	Normal indicates that this fan is functioning above the minimum speed. Error indicates that this fan is functioning below the minimum speed.
Voltage (V)	The power supply for each voltage has a sensor that is capable of detecting and reporting if the voltage falls out of the tolerance range.
Current	This is the current voltage reading.
MAX	This field displays the maximum voltage measured at this point.
MIN	This field displays the minimum voltage measured at this point.
Threshold	This field displays the minimum voltage at which the switch should work.
Status	Normal indicates that the voltage is within an acceptable operating range at this point; otherwise Error is displayed.

7.3 General Setup

Use this screen to enter administrative details, time settings and login precedence. Click **Basic Setting** and **General Setup** in the navigation panel to display the screen as shown.

Figure 32 General Setup

The following table describes the labels in this screen.

Table 10 General Setup

LABEL	DESCRIPTION
System Name	Choose a descriptive name for identification purposes. This name consists of up to 64 printable characters; spaces are allowed.
Location	Enter the geographic location (up to 32 characters) of your switch.
Contact Person's Name	Enter the name (up to 32 characters) of the person in charge of this switch.
Login Precedence	<p>Use this drop-down list box to select which database the switch should use (first) to authenticate an administrator (user for switch management).</p> <p>Local user accounts can be configured via the Access Control Logins screen or via the commands. The commands allow you to configure different levels of privilege. See Section 30.6 on page 185 for more information on creating accounts via commands.</p> <p>You can also configure user accounts and privileges on a RADIUS server. The RADIUS is an external server. Before you specify the priority, make sure you have set up the corresponding database correctly first.</p> <p>Select Local Only to have the switch just check the administrator accounts configured in the Access Control Logins screen or via commands.</p> <p>Select Local then RADIUS to have the switch check the accounts configured in the Access Control Logins screen or commands. If the user name is not found, the switch then checks the user database on the specified RADIUS server. You need to configure Port Authentication Radius first.</p> <p>Select RADIUS Only to have the switch just check the user database on the specified RADIUS server for a login username, password and privilege level.</p>

Table 10 General Setup (continued)

LABEL	DESCRIPTION
Use Time Server when Bootup	<p>Enter the time service protocol that your timeserver uses. Not all time servers support all protocols, so you may have to use trial and error to find a protocol that works. The main differences between them are the time format.</p> <p>When you select the Daytime (RFC 867) format, the switch displays the day, month, year and time with no time zone adjustment. When you use this format it is recommended that you use a Daytime timeserver within your geographical time zone.</p> <p>Time (RFC-868) format displays a 4-byte integer giving the total number of seconds since 1970/1/1 at 0:0:0.</p> <p>NTP (RFC-1305) is similar to Time (RFC-868).</p> <p>None is the default value. Enter the time manually. Each time you turn on the switch, the time and date will be reset to 2000-1-1 0:0.</p>
Time Server IP Address	Enter the IP address of your timeserver. The switch searches for the timeserver for up to 60 seconds. If you select a timeserver that is unreachable, then this screen will appear locked for 60 seconds. Please wait.
Current Time	This field displays the time you open this menu (or refresh the menu).
New Time (hh:min:ss)	Enter the new time in hour, minute and second format. The new time then appears in the Current Time field after you click Apply .
Current Date	This field displays the date you open this menu.
New Date (yyyy-mm-dd)	Enter the new date in year, month and day format. The new date then appears in the Current Date field after you click Apply .
Time Zone	Select the time difference between UTC (Universal Time Coordinated, formerly known as GMT, Greenwich Mean Time) and your time zone from the drop-down list box.
Apply	Click Apply to save your changes to the switch's run-time memory. The switch loses these changes if it is turned off or loses power, so use the Save link on the top navigation panel to save your changes to the non-volatile memory when you are done configuring.
Cancel	Click Cancel to reset the fields to your previous configuration.

7.4 Introduction to VLANs

A VLAN (Virtual Local Area Network) allows a physical network to be partitioned into multiple logical networks. Devices on a logical network belong to one group. A device can belong to more than one group. With VLAN, a device cannot directly talk to or hear from devices that are not in the same group(s); the traffic must first go through a router.

In MTU (Multi-Tenant Unit) applications, VLAN is vital in providing isolation and security among the subscribers. When properly configured, VLAN prevents one subscriber from accessing the network resources of another on the same LAN, thus a user will not see the printers and hard disks of another user in the same building.

VLAN also increases network performance by limiting broadcasts to a smaller and more manageable logical broadcast domain. In traditional switched environments, all broadcast packets go to each and every individual port. With VLAN, all broadcasts are confined to a specific broadcast domain.

Note: VLAN is unidirectional; it only governs outgoing traffic.

See [Chapter 8 on page 83](#) for information on port-based and 802.1Q tagged VLANs.

7.5 Switch Setup Screen

Click **Basic Setting** and then **Switch Setup** in the navigation panel to display the screen as shown. The VLAN setup screens change depending on whether you choose **802.1Q** or **Port Based** in the **VLAN Type** field in this screen. Refer to the chapter on VLAN.

Figure 33 Switch Setup

The following table describes the labels in this screen.

Table 11 Switch Setup

LABEL	DESCRIPTION
VLAN Type	Choose 802.1Q or Port Based . The VLAN Setup screen changes depending on whether you choose 802.1Q VLAN type or Port Based VLAN type in this screen. See Chapter 8 on page 83 for more information.
MAC Address Learning	MAC address learning reduces outgoing traffic broadcasts. For MAC address learning to occur on a port, the port must be active.
Aging Time	Enter a time from 10 to 3000 seconds. This is how long all dynamically learned MAC addresses remain in the MAC address table before they age out (and must be relearned).
GARP Timer: Switches join VLANs by making a declaration. A declaration is made by issuing a Join message using GARP. Declarations are withdrawn by issuing a Leave message. A Leave All message terminates all registrations. GARP timers set declaration timeout values. See the chapter on VLAN setup for more background information.	

Table 11 Switch Setup (continued)

LABEL	DESCRIPTION
Join Timer	Join Timer sets the duration of the Join Period timer for GVRP in milliseconds. Each port has a Join Period timer. The allowed Join Time range is between 100 and 65535 milliseconds; the default is 200 milliseconds. See the chapter on VLAN setup for more background information.
Leave Timer	Leave Time sets the duration of the Leave Period timer for GVRP in milliseconds. Each port has a single Leave Period timer. Leave Time must be two times larger than Join Timer ; the default is 600 milliseconds.
Leave All Timer	Leave All Timer sets the duration of the Leave All Period timer for GVRP in milliseconds. Each port has a single Leave All Period timer. Leave All Timer must be larger than Leave Timer; the default is 10000 milliseconds.
<p>Priority Queue Assignment</p> <p>IEEE 802.1p defines up to eight separate traffic types by inserting a tag into a MAC-layer frame that contains bits to define class of service. Frames without an explicit priority tag are given the default priority of the ingress port. Use the next two fields to configure the priority level-to-physical queue mapping.</p> <p>The switch has four physical queues that you can map to the 8 priority levels. On the switch, traffic assigned to higher index queues gets through faster while traffic in lower index queues is dropped if the network is congested.</p>	
Priority Level	(The following descriptions are based on the traffic types defined in the IEEE 802.1d standard (which incorporates the 802.1p).
Level 7	Typically used for network control traffic such as router configuration messages.
Level 6	Typically used for voice traffic that is especially sensitive to jitter (jitter is the variations in delay).
Level 5	Typically used for video that consumes high bandwidth and is sensitive to jitter.
Level 4	Typically used for controlled load, latency-sensitive traffic such as SNA (Systems Network Architecture) transactions.
Level 3	Typically used for "excellent effort" or better than best effort and would include important business traffic that can tolerate some delay.
Level 2	This is for "spare bandwidth".
Level 1	This is typically used for non-critical "background" traffic such as bulk transfers that are allowed but that should not affect other applications and users.
Level 0	Typically used for best-effort traffic.
Apply	Click Apply to save your changes to the switch's run-time memory. The switch loses these changes if it is turned off or loses power, so use the Save link on the top navigation panel to save your changes to the non-volatile memory when you are done configuring.
Cancel	Click Cancel to reset the fields to your previous configuration.

7.6 IP Setup

Use the **IP Setup** screen to configure the default gateway device, the default domain name server and add switch IP address.

7.6.1 Management IP Addresses

The switch needs an IP address for it to be managed over the network. The factory default IP address is 192.168.1.1. The subnet mask specifies the network number portion of an IP address. The factory default subnet mask is 255.255.255.0.

You can configure up to 64 IP addresses which are used to access and manage the switch from the ports belonging to the pre-defined VLAN(s).

Note: You must configure a VLAN first.

Figure 34 IP Setup

The following table describes the labels in this screen.

Table 12 IP Setup

LABEL	DESCRIPTION
Domain Name Server	DNS (Domain Name System) is for mapping a domain name to its corresponding IP address and vice versa. Enter a domain name server IP address in order to be able to use a domain name instead of an IP address.
Default Management IP Address	Configure the fields to set the default management IP address.
DHCP Client	Select this option if you have a DHCP server that can assign the switch an IP address and subnet mask, a default gateway IP address and a domain name server IP address.

Table 12 IP Setup (continued)

LABEL	DESCRIPTION
Static IP Address	Select this option if you don't have a DHCP server or if you wish to assign static IP address information to the switch. You need to fill in the following fields when you select this option.
IP Address	Enter the IP address of your switch in dotted decimal notation for example 192.168.1.1.
IP Subnet Mask	Enter the IP subnet mask of your switch in dotted decimal notation for example 255.255.255.0.
Default Gateway	Enter the IP address of the default outgoing gateway in dotted decimal notation, for example 192.168.1.254
VID	Enter the VLAN identification number associated with the switch IP address. This is the VLAN ID of the CPU and is used for management only. The default is "1". All ports, by default, are fixed members of this "management VLAN" in order to manage the device from any port. If a port is not a member of this VLAN, then users on that port cannot access the device. To access the switch make sure the port that you are connected to is a member of Management VLAN.
Apply	Click Apply to save your changes to the switch's run-time memory. The switch loses these changes if it is turned off or loses power, so use the Save link on the top navigation panel to save your changes to the non-volatile memory when you are done configuring.
Cancel	Click Cancel to reset the fields to your previous configuration.
Management IP Addresses	Configure the fields to set additional management IP address.
IP Address	Enter the IP address for managing the switch by the members of the VLAN specified in the VID field below.
IP Subnet Mask	Enter the IP subnet mask in dotted decimal notation. For example, 255.255.255.0.
VID	Enter the VLAN identification number.
Add	Click Add to save your changes to the switch's run-time memory. The switch loses these changes if it is turned off or loses power, so use the Save link on the top navigation panel to save your changes to the non-volatile memory when you are done configuring.
Cancel	Click Cancel to reset the fields to your previous configuration.
Index	This field displays the index number of an entry.
IP Address	This field displays the management IP address of the switch.
IP Subnet Mask	This field displays the subnet mask of the switch.
VID	This field displays the VLAN identification number of the network.
Default Gateway	This field displays the default gateway of the switch.
Delete	Click Delete to remove the selected entry from the summary table.
Cancel	Click Cancel to clear the Delete check boxes.

7.7 Port Setup

Ethernet port connections can be in half-duplex or full-duplex mode. Full-duplex refers to a device's ability to send and receive simultaneously, while half-duplex indicates that traffic can flow in only one direction at a time. The Ethernet port must use the same speed or duplex mode setting as the peer Ethernet port in order to connect.

Full-duplex mode operation only applies to point-to-point access (for example, when attaching the switch to a workstation, server, or another switch). When connecting to hubs, use a standard cascaded connection set at half-duplex operation.

Auto-negotiation regulates the speed and duplex of each port, based on the capability of both devices. When auto-negotiation is turned on, an Ethernet port on the switch negotiates with the peer automatically to determine the connection speed and duplex mode. If the peer Ethernet port does not support auto-negotiation or turns off this feature, the switch determines the connection speed by detecting the signal on the cable and using half duplex mode. When the switch's auto-negotiation is turned off, an Ethernet port uses the preconfigured speed and duplex mode when making a connection, thus requiring you to make sure that the settings of the peer Ethernet port are the same in order to connect.

Use this screen to configure switch port settings. Click **Basic Setting** and then **Port Setup** in the navigation panel to enter the port configuration screen.

Note: The ES-2108PWR screen is different from the other models covered in this UG. The screen from ES-2108-G model is shown for comparison.

Figure 35 Port Setup (ES-2108PWR)

Port	Active	Name	Type	Speed / Duplex	Flow Control	802.1p Priority	PD
*	<input checked="" type="checkbox"/>		-	Auto	<input type="checkbox"/>	0	<input type="checkbox"/>
1	<input checked="" type="checkbox"/>		10/100M	Auto	<input type="checkbox"/>	0	<input checked="" type="checkbox"/>
2	<input checked="" type="checkbox"/>		10/100M	Auto	<input type="checkbox"/>	0	<input checked="" type="checkbox"/>
3	<input checked="" type="checkbox"/>		10/100M	Auto	<input type="checkbox"/>	0	<input checked="" type="checkbox"/>
4	<input checked="" type="checkbox"/>		10/100M	Auto	<input type="checkbox"/>	0	<input checked="" type="checkbox"/>
5	<input checked="" type="checkbox"/>		10/100M	Auto	<input type="checkbox"/>	0	<input checked="" type="checkbox"/>
6	<input checked="" type="checkbox"/>		10/100M	Auto	<input type="checkbox"/>	0	<input checked="" type="checkbox"/>
7	<input checked="" type="checkbox"/>		10/100M	Auto	<input type="checkbox"/>	0	<input checked="" type="checkbox"/>
8	<input checked="" type="checkbox"/>		10/100M	Auto	<input type="checkbox"/>	0	<input checked="" type="checkbox"/>
9	<input checked="" type="checkbox"/>		10/100/1000M	Auto	<input type="checkbox"/>	0	-

Figure 36 Port Setup (ES-2108-G)

Port	Active	Name	Type	Speed / Duplex	Flow Control	802.1p Priority
1	<input checked="" type="checkbox"/>	port01	10/100M	Auto	<input type="checkbox"/>	0
2	<input checked="" type="checkbox"/>	port02	10/100M	Auto	<input type="checkbox"/>	0
3	<input checked="" type="checkbox"/>	port03	10/100M	Auto	<input type="checkbox"/>	0
4	<input checked="" type="checkbox"/>	port04	10/100M	Auto	<input type="checkbox"/>	0
5	<input checked="" type="checkbox"/>	port05	10/100M	Auto	<input type="checkbox"/>	0
6	<input checked="" type="checkbox"/>	port06	10/100M	Auto	<input type="checkbox"/>	0
7	<input checked="" type="checkbox"/>	port07	10/100M	Auto	<input type="checkbox"/>	0
8	<input checked="" type="checkbox"/>	port08	10/100M	Auto	<input type="checkbox"/>	0
9	<input checked="" type="checkbox"/>	port09	10/100/1000M	Auto	<input type="checkbox"/>	0

Apply Cancel

The following table describes the labels in this screen.

Table 13 Port Setup

LABEL	DESCRIPTION
*	Settings in this row apply to all ports. Use this row only if you want to make some settings the same for all ports. Use this row first to set the common settings and then make adjustments on a port-by-port basis. Note: Changes in this row are copied to all the ports as soon as you make them.
Port	This is the port index number.
Active	Select this check box to enable a port. The factory default for all ports is enabled. A port must be enabled for data transmission to occur.
Name	Enter a descriptive name that identifies this port. You can enter up to 64 alpha-numerical characters. Note: Due to space limitation, the port name may be truncated in some web configurator screens.
Type	This field displays 10/100M for an Ethernet connection and 10/100/1000M for the Gigabit Ethernet/mini-GBIC ports and 100M for a 100 base-FX fiber-optic port on the ES-2108-LC or a Fast Ethernet SFP transceiver connection on the ES-2108-F.

Table 13 Port Setup (continued)

LABEL	DESCRIPTION
Speed/Duplex	<p>Select the speed and the duplex mode of the Ethernet connection on this port.</p> <p>For Ethernet ports, select Auto, 10M/Half Duplex, 10M/Full Duplex, 100M/Half Duplex or 100M/Full Duplex.</p> <p>For the Gigabit Ethernet/mini-GBIC port, select Auto, 10M/Half Duplex, 10M/Full Duplex, 100M/Half Duplex, 100M/Full Duplex or 1000M/Full Duplex.</p> <p>For the mini-GBIC port on the ES-2108-LC, select Auto or 1000M/Full Duplex.</p> <p>The port speed and the duplex mode are fixed (100M/Full Duplex) for the 100 Base-FX fiber optic port on the ES-2108-LC and the Fast Ethernet SFP transceiver connection on the ES-2108-F.</p> <p>Selecting Auto (auto-negotiation) allows one port to negotiate with a peer port automatically to obtain the connection speed and duplex mode that both ends support. When auto-negotiation is turned on, a port on the switch negotiates with the peer automatically to determine the connection speed and duplex mode. If the peer port does not support auto-negotiation or turns off this feature, the switch determines the connection speed by detecting the signal on the cable and using half duplex mode. When the switch's auto-negotiation is turned off, a port uses the pre-configured speed and duplex mode when making a connection, thus requiring you to make sure that the settings of the peer port are the same in order to connect.</p>
Flow Control	<p>A concentration of traffic on a port decreases port bandwidth and overflows buffer memory causing packet discards and frame losses. Flow Control is used to regulate transmission of signals to match the bandwidth of the receiving port.</p> <p>The switch uses IEEE802.3x flow control in full duplex mode and back-pressure flow control in half duplex mode.</p> <p>IEEE802.3x flow control is used in full duplex mode to send a pause signal to the sending port, causing it to temporarily stop sending signals when the receiving port memory buffers fill.</p> <p>Back Pressure flow control is typically used in half duplex mode to send a "collision" signal to the sending port (mimicking a state of packet collision) causing the sending port to temporarily stop sending signals and resend later. Select Flow Control to enable it.</p>
802.1P Priority	<p>This priority value is added to incoming frames without a (802.1p) priority queue tag. See Priority Queue Assignment in Table 11 on page 76 for more information.</p>
PD (ES-2108PWR Only)	<p>This field is only available on the ES-2108PWR but not available for the Gigabit or mini-GBIC ports.</p> <p>A powered device (PD) is a device such as an access point or a switch, that supports PoE (Power over Ethernet) so that it can receive power from another device through a 10/100Mbps Ethernet port.</p> <p>Select the check box to allow a powered device (connected to the port) to receive power from the switch.</p>
Apply	<p>Click Apply to save your changes to the switch's run-time memory. The switch loses these changes if it is turned off or loses power, so use the Save link on the top navigation panel to save your changes to the non-volatile memory when you are done configuring.</p>
Cancel	<p>Click Cancel to reset the fields to your previous configuration.</p>

CHAPTER 8

VLAN

The type of screen you see here depends on the **VLAN Type** you selected in the **Switch Setup** screen. This chapter shows you how to configure 802.1Q tagged and port-based VLANs.

8.1 Introduction to IEEE 802.1Q Tagged VLAN

A tagged VLAN uses an explicit tag (VLAN ID) in the MAC header to identify the VLAN membership of a frame across bridges - they are not confined to the switch on which they were created. The VLANs can be created statically by hand or dynamically through GVRP. The VLAN ID associates a frame with a specific VLAN and provides the information that switches need to process the frame across the network. A tagged frame is four bytes longer than an untagged frame and contains two bytes of TPID (Tag Protocol Identifier, residing within the type/length field of the Ethernet frame) and two bytes of TCI (Tag Control Information, starts after the source address field of the Ethernet frame).

The CFI (Canonical Format Indicator) is a single-bit flag, always set to zero for Ethernet switches. If a frame received at an Ethernet port has a CFI set to 1, then that frame should not be forwarded as it is to an untagged port. The remaining twelve bits define the VLAN ID, giving a possible maximum number of 4,096 (2¹²) VLANs. Note that user priority and VLAN ID are independent of each other. A frame with VID (VLAN Identifier) of null (0) is called a priority frame, meaning that only the priority level is significant and the default VID of the ingress port is given as the VID of the frame. Of the 4096 possible VIDs, a VID of 0 is used to identify priority frames and value 4095 (FFF) is reserved, so the maximum possible VLAN configurations are 4,094.

TPID	User Priority	CFI	VLAN ID
2 Bytes	3 Bits	1 Bit	12 bits

8.1.1 Forwarding Tagged and Untagged Frames

Each port on the switch is capable of passing tagged or untagged frames. To forward a frame from an 802.1Q VLAN-aware switch to an 802.1Q VLAN-unaware switch, the switch first decides where to forward the frame and then strips off the VLAN tag. To forward a frame from an 802.1Q VLAN-unaware switch to an 802.1Q VLAN-aware switch, the switch first decides where to forward the frame, and then inserts a VLAN tag reflecting the ingress port's default VID. The default PVID is VLAN 1 for all ports, but this can be changed.

8.2 Automatic VLAN Registration

GARP and GVRP are the protocols used to automatically register VLAN membership across switches.

8.2.1 GARP

GARP (Generic Attribute Registration Protocol) allows network switches to register and de-register attribute values with other GARP participants within a bridged LAN. GARP is a protocol that provides a generic mechanism for protocols that serve a more specific application, for example, GVRP.

8.2.1.1 GARP Timers

Switches join VLANs by making a declaration. A declaration is made by issuing a Join message using GARP. Declarations are withdrawn by issuing a Leave message. A Leave All message terminates all registrations. GARP timers set declaration timeout values.

8.2.2 GVRP

GVRP (GARP VLAN Registration Protocol) is a registration protocol that defines a way for switches to register necessary VLAN members on ports across the network. Enable this function to permit VLANs groups beyond the local switch.

Please refer to the following table for common GARP terminology.

Table 14 IEEE 802.1q Terminology

VLAN PARAMETER	TERM	DESCRIPTION
VLAN Type	Permanent VLAN	This is a static VLAN created manually.
	Dynamic VLAN	This is a VLAN configured by a GVRP registration/deregistration process.
VLAN Administrative Control	Registration Fixed	Fixed registration ports are permanent VLAN members.
	Registration Forbidden	Ports with registration forbidden are forbidden to join the specified VLAN.
	Normal Registration	Ports dynamically join a VLAN using GVRP.
VLAN Tag Control	Tagged	Ports belonging to the specified VLAN tag all outgoing frames transmitted.
	Untagged	Ports belonging to the specified don't tag all outgoing frames transmitted.

Table 14 IEEE 802.1q Terminology (continued)

VLAN PARAMETER	TERM	DESCRIPTION
VLAN Port	Port VID	This is the VLAN ID assigned to untagged frames that this port received.
	Acceptable frame type	You may choose to accept both tagged and untagged incoming frames or just tagged incoming frames on a port.
	Ingress filtering	If set, the switch discards incoming frames for VLANs that do not have this port as a member

8.3 Port VLAN Trunking

Enable **VLAN Trunking** on a port to allow frames belonging to unknown VLAN groups to pass through that port. This is useful if you want to set up VLAN groups on end devices without having to configure the same VLAN groups on intermediary devices.

Refer to the following figure. Suppose you want to create VLAN groups 1 and 2 (V1 and V2) on devices A and B. Without **VLAN Trunking**, you must configure VLAN groups 1 and 2 on all intermediary switches C, D and E; otherwise they will drop frames with unknown VLAN group tags. However, with **VLAN Trunking** enabled on a port(s) in each intermediary switch you only need to create VLAN groups in the end devices (A and B). C, D and E automatically allow frames with VLAN group tags 1 and 2 (VLAN groups that are unknown to those switches) to pass through their VLAN trunking port(s).

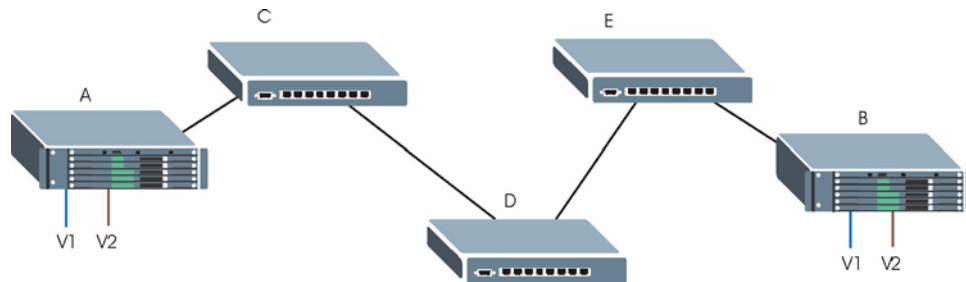
Figure 37 Port VLAN Trunking

8.4 Select the VLAN Type

- 1 Select a VLAN type in the **Switch Setup** screen.

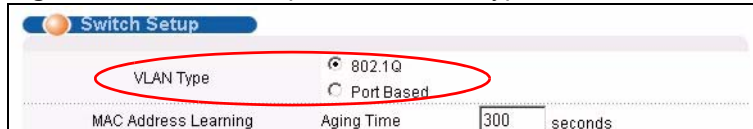
Figure 38 Switch Setup: Select VLAN Type

8.5 Static VLAN

Use a static VLAN to decide whether an incoming frame on a port should be

- sent to a VLAN group as normal depends on its VLAN tag.
- sent to a group whether it has a VLAN tag or not.
- blocked from a VLAN group regardless of its VLAN tag.

You can also tag all outgoing frames (that were previously untagged) from a port with the specified VID.

8.5.1 Static VLAN Status

See [Section 8.1 on page 83](#) for more information on Static VLAN. Click **Advanced Application**, **VLAN** from the navigation panel to display the **VLAN Status** screen as shown next.

Figure 39 VLAN: VLAN Status

Index	VID	Elapsed Time	Status
1	1	0:03:21	Static
2	2	0:03:21	Static

The following table describes the labels in this screen.

Table 15 VLAN: VLAN Status

LABEL	DESCRIPTION
The Number of VLAN	This is the number of VLANs configured on the switch.
Index	This is the VLAN index number. Click on this to view port settings for the specified VLAN.
VID	This is the VLAN identification number that was configured in the Static VLAN screen.

Table 15 VLAN: VLAN Status (continued)

LABEL	DESCRIPTION
Elapsed Time	This field shows how long it has been since a normal VLAN was registered or a static VLAN was set up.
Status	This field shows how this VLAN was added to the switch; dynamic - using GVRP, static - added as a permanent entry or it shows other - added using Multicast VLAN Registration (MVR).
Change Pages	Click Previous or Next to show the previous/next screen if all status information cannot be seen in one screen.

8.5.2 Static VLAN Details

Use this screen to view detailed port settings and status of the VLAN group. See [Section 8.1 on page 83](#) for more information on static VLANs. Click on an index number in the **VLAN Status** screen to display VLAN details.

Figure 40 Static VLAN Details

VID	Port Number					Elapsed Time	Status
	2	4	6	8	1		
1	U	U	U	U	U	0:47:03	Static

The following table describes the labels in this screen.

Table 16 Static VLAN Details

LABEL	DESCRIPTION
VLAN Status	Click this to go to the VLAN Status screen.
VID	This is the VLAN identification number that was configured in the Static VLAN screen.
Port Number	This column displays the ports that are participating in a VLAN. A tagged port is marked as T , an untagged port is marked as U and ports not participating in a VLAN are marked as – .
Elapsed Time	This field shows how long it has been since a normal VLAN was registered or a static VLAN was set up.
Status	This field shows how this VLAN was added to the switch; dynamic - using GVRP, static - added as a permanent entry or it shows other - added using Multicast VLAN Registration (MVR).

8.5.3 Configure a Static VLAN

Use this screen to configure and view 802.1Q VLAN parameters for the switch. See [Section 8.5 on page 86](#) for more information on static VLAN. To configure a static VLAN, click **Static VLAN** in the **VLAN Status** screen to display the screen as shown next.

Figure 41 VLAN: Static VLAN

The following table describes the related labels in this screen.

Table 17 VLAN: Static VLAN

LABEL	DESCRIPTION
ACTIVE	Select this check box to activate the VLAN settings.
Name	Enter a descriptive name for the VLAN group for identification purposes.
VLAN Group ID	Enter the VLAN ID for this static entry; the valid range is between 1 and 4094.
Port	The port number identifies the port you are configuring.
*	Settings in this row apply to all ports. Use this row only if you want to make some settings the same for all ports. Use this row first to set the common settings and then make adjustments on a port-by-port basis. Note: Changes in this row are copied to all the ports as soon as you make them.
Control	Select Normal for the port to dynamically join this VLAN group using GVRP. This is the default selection. Select Fixed for the port to be a permanent member of this VLAN group. Select Forbidden if you want to prohibit the port from joining this VLAN group.
Tagging	Select TX Tagging if you want the port to tag all outgoing frames transmitted with this VLAN Group ID.
Add	Click Add to save your changes to the switch's run-time memory. The switch loses these changes if it is turned off or loses power, so use the Save link on the top navigation panel to save your changes to the non-volatile memory when you are done configuring.

Table 17 VLAN: Static VLAN (continued)

LABEL	DESCRIPTION
Cancel	Click Cancel to reset the fields.
Clear	Click Clear to start configuring the screen again.
VID	This field displays the ID number of the VLAN group. Click the number to edit the VLAN settings.
Active	This field indicates whether the VLAN settings are enabled (Yes) or disabled (No).
Name	This field displays the descriptive name for this VLAN group.
Delete	Click Delete to remove the selected entry from the summary table.
Cancel	Click Cancel to clear the Delete check boxes.

8.5.4 Configure VLAN Port Settings

Use the VLAN Port Setting screen to configure the static VLAN (IEEE 802.1Q) settings on a port. See [Section 8.5 on page 86](#) for more information on static VLAN. Click the **VLAN Port Setting** link in the **VLAN Status** screen.

Figure 42 VLAN: VLAN Port Setting

The following table describes the labels in this screen.

Table 18 VLAN: VLAN Port Setting

LABEL	DESCRIPTION
GVRP	GVRP (GARP VLAN Registration Protocol) is a registration protocol that defines a way for switches to register necessary VLAN members on ports across the network. Select this check box to permit VLAN groups beyond the local switch.
Port Isolation	Port Isolation allows each port to communicate only with the CPU management port and the uplink ports but not communicate with each other. This option is the most limiting but also the most secure.
Ingress Check	Select this check box to activate ingress filtering on the switch. Clear this check box to disable ingress filtering the switch.
Port	This field displays the port number.
*	Settings in this row apply to all ports. Use this row only if you want to make some settings the same for all ports. Use this row first to set the common settings and then make adjustments on a port-by-port basis. Note: Changes in this row are copied to all the ports as soon as you make them.
PVID	Enter a number between 1 and 4094 as the port VLAN ID.
GVRP	Select this check box to allow GVRP on this port.
Acceptable Frame Type	Specify the type of frames allowed on a port. Choices are All and Tag Only . Select All from the drop-down list box to accept all untagged or tagged frames on this port. This is the default setting. Select Tag Only to accept only tagged frames on this port. All untagged frames will be dropped.

Table 18 VLAN: VLAN Port Setting (continued)

LABEL	DESCRIPTION
VLAN Trunking	Enable VLAN Trunking on ports connected to other switches or routers (but not ports directly connected to end users) to allow frames belonging to unknown VLAN groups to pass through the switch.
Apply	Click Apply to save your changes to the switch's run-time memory. The switch loses these changes if it is turned off or loses power, so use the Save link on the top navigation panel to save your changes to the non-volatile memory when you are done configuring.
Cancel	Click Cancel to start configuring the screen again.

8.6 Port Based VLAN Setup

Port-based VLANs are VLANs where the packet forwarding decision is based on the destination MAC address and its associated port.

Port-based VLANs require allowed outgoing ports to be defined for each port. Therefore, if you wish to allow two subscriber ports to talk to each other, for example, between conference rooms in a hotel, you must define the egress (an egress port is an outgoing port, that is, a port through which a data packet leaves) for both ports.

Port-based VLANs are specific only to the switch on which they were created.

Note: When you activate port-based VLAN, the switch uses a default VLAN ID of 1. You cannot change it.

In screens (such as **IP Setup** and **Filtering**) that require a VID, you must enter 1 as the VID.

The port-based VLAN setup screen is shown next. The **CPU** management port forms a VLAN with all Ethernet ports.

8.6.1 Configure a Port-based VLAN

Select **Port Based** as the **VLAN Type** in the **Switch Setup** screen (see [Figure 38 on page 86](#)) and then click **VLAN** from the navigation panel to display the next screen.

Figure 43 Port Based VLAN Setup (All Connected)

● Port Based VLAN Setup

Setting Wizard All connected ▾ Apply

Incoming

	1	2	3	4	5	6	7	8	9	
	<input checked="" type="checkbox"/>	<input checked="" type="checkbox"/>	<input checked="" type="checkbox"/>	<input checked="" type="checkbox"/>	<input checked="" type="checkbox"/>	<input checked="" type="checkbox"/>	<input checked="" type="checkbox"/>	<input checked="" type="checkbox"/>	<input checked="" type="checkbox"/>	1
	<input checked="" type="checkbox"/>	<input checked="" type="checkbox"/>	<input checked="" type="checkbox"/>	<input checked="" type="checkbox"/>	<input checked="" type="checkbox"/>	<input checked="" type="checkbox"/>	<input checked="" type="checkbox"/>	<input checked="" type="checkbox"/>	<input checked="" type="checkbox"/>	2
	<input checked="" type="checkbox"/>	<input checked="" type="checkbox"/>	<input checked="" type="checkbox"/>	<input checked="" type="checkbox"/>	<input checked="" type="checkbox"/>	<input checked="" type="checkbox"/>	<input checked="" type="checkbox"/>	<input checked="" type="checkbox"/>	<input checked="" type="checkbox"/>	3
	<input checked="" type="checkbox"/>	<input checked="" type="checkbox"/>	<input checked="" type="checkbox"/>	<input checked="" type="checkbox"/>	<input checked="" type="checkbox"/>	<input checked="" type="checkbox"/>	<input checked="" type="checkbox"/>	<input checked="" type="checkbox"/>	<input checked="" type="checkbox"/>	4
	<input checked="" type="checkbox"/>	<input checked="" type="checkbox"/>	<input checked="" type="checkbox"/>	<input checked="" type="checkbox"/>	<input checked="" type="checkbox"/>	<input checked="" type="checkbox"/>	<input checked="" type="checkbox"/>	<input checked="" type="checkbox"/>	<input checked="" type="checkbox"/>	5
Outgoing	<input checked="" type="checkbox"/>	<input checked="" type="checkbox"/>	<input checked="" type="checkbox"/>	<input checked="" type="checkbox"/>	<input checked="" type="checkbox"/>	<input checked="" type="checkbox"/>	<input checked="" type="checkbox"/>	<input checked="" type="checkbox"/>	<input checked="" type="checkbox"/>	6
	<input checked="" type="checkbox"/>	<input checked="" type="checkbox"/>	<input checked="" type="checkbox"/>	<input checked="" type="checkbox"/>	<input checked="" type="checkbox"/>	<input checked="" type="checkbox"/>	<input checked="" type="checkbox"/>	<input checked="" type="checkbox"/>	<input checked="" type="checkbox"/>	7
	<input checked="" type="checkbox"/>	<input checked="" type="checkbox"/>	<input checked="" type="checkbox"/>	<input checked="" type="checkbox"/>	<input checked="" type="checkbox"/>	<input checked="" type="checkbox"/>	<input checked="" type="checkbox"/>	<input checked="" type="checkbox"/>	<input checked="" type="checkbox"/>	8
	<input checked="" type="checkbox"/>	<input checked="" type="checkbox"/>	<input checked="" type="checkbox"/>	<input checked="" type="checkbox"/>	<input checked="" type="checkbox"/>	<input checked="" type="checkbox"/>	<input checked="" type="checkbox"/>	<input checked="" type="checkbox"/>	<input checked="" type="checkbox"/>	9
CPU	<input checked="" type="checkbox"/>	<input checked="" type="checkbox"/>	<input checked="" type="checkbox"/>	<input checked="" type="checkbox"/>	<input checked="" type="checkbox"/>	<input checked="" type="checkbox"/>	<input checked="" type="checkbox"/>	<input checked="" type="checkbox"/>	<input checked="" type="checkbox"/>	CPU
	1	2	3	4	5	6	7	8	9	

Apply Cancel

Figure 44 Port Based VLAN Setup (Port Isolation)

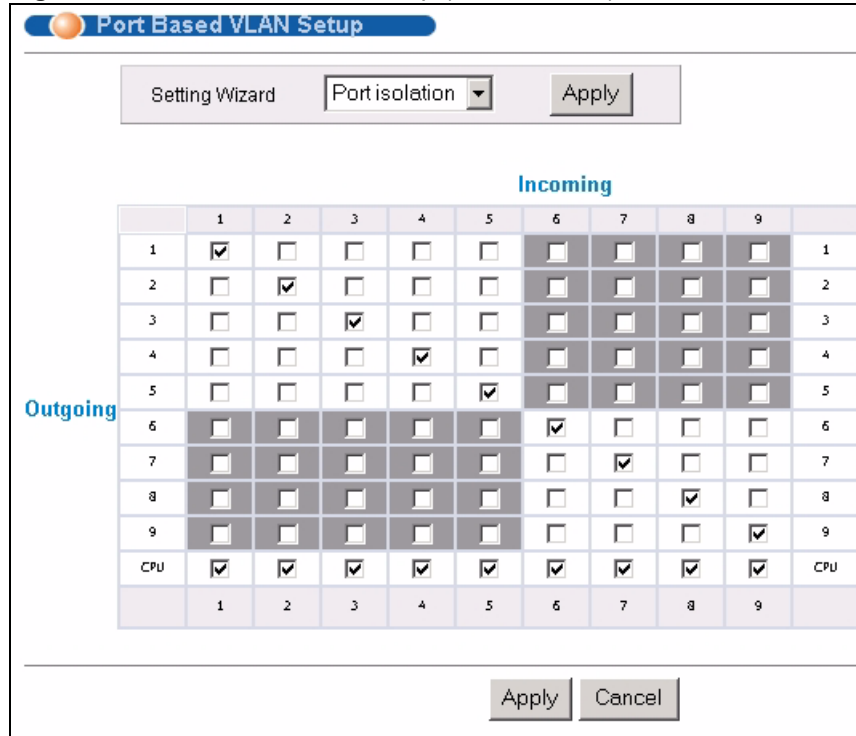

The following table describes the labels in this screen.

Table 19 Port Based VLAN Setup

LABEL	DESCRIPTION
Setting Wizard	<p>Choose All connected or Port isolation.</p> <p>All connected means all ports can communicate with each other, that is, there are no virtual LANs. All incoming and outgoing ports are selected. This option is the most flexible but also the least secure.</p> <p>Port isolation means that each port can only communicate with the CPU management port and cannot communicate with each other. All incoming ports are selected while only the CPU outgoing port is selected. This option is the most limiting but also the most secure.</p> <p>After you make your selection, click Apply (top right of screen) to display the screens as mentioned above. You can still customize these settings by adding/deleting incoming or outgoing ports, but you must also click Apply at the bottom of the screen.</p>
Incoming	<p>These are the ingress ports; an ingress port is an incoming port, that is, a port through which a data packet enters. If you wish to allow two subscriber ports to talk to each other, you must define the ingress port for both ports. The numbers in the top row denote the incoming port for the corresponding port listed on the left (its outgoing port). CPU refers to the switch management port. By default it forms a VLAN with all Ethernet ports. If it does not form a VLAN with a particular port then the switch cannot be managed from that port.</p>
Outgoing	<p>These are the egress ports; an egress port is an outgoing port, that is, a port through which a data packet leaves. If you wish to allow two subscriber ports to talk to each other, you must define the egress port for both ports. CPU refers to the switch management port. By default it forms a VLAN with all Ethernet ports. If it does not form a VLAN with a particular port then the switch cannot be managed from that port.</p>

Table 19 Port Based VLAN Setup (continued)

LABEL	DESCRIPTION
Apply	Click Apply to save your changes to the switch's run-time memory. The switch loses these changes if it is turned off or loses power, so use the Save link on the top navigation panel to save your changes to the non-volatile memory when you are done configuring.
Cancel	Click Cancel to start configuring the screen again.

CHAPTER 9

Static MAC Forwarding

Use these screens to configure static MAC address forwarding.

9.1 Overview

A static MAC address is an address that has been manually entered in the MAC address table. Static MAC addresses do not age out. When you set up static MAC address rules, you are setting static MAC addresses for a port. This may reduce the need for broadcasting.

Static MAC address forwarding together with port security allow only computers in the MAC address table on a port to access the switch. See [Chapter 17 on page 121](#) for more information on port security.

9.2 Configuring Static MAC Forwarding

A static MAC address is an address that has been manually entered in the MAC address table. Static MAC addresses do not age out. When you set up static MAC address rules, you are setting static MAC addresses for a port. This may reduce the need for broadcasting.

Static MAC address forwarding together with port security allow only computers in the MAC address table on a port to access the switch. See [Chapter 17 on page 121](#) for more information on port security.

Click **Advanced Applications, Static MAC Forwarding** in the navigation panel to display the configuration screen as shown.

Figure 45 Static MAC Forwarding

The following table describes the labels in this screen.

Table 20 Static MAC Forwarding

LABEL	DESCRIPTION
Active	Select this check box to activate your rule. You may temporarily deactivate a rule without deleting it by clearing this check box.
Name	Enter a descriptive name for identification purposes for this static MAC address forwarding rule.
MAC Address	Enter the MAC address in valid MAC address format, that is, six hexadecimal character pairs. Note: Static MAC addresses do not age out.
VID	Enter the VLAN identification number.
Port	Type the port number where the MAC address entered in the previous field will be automatically forwarded.
Add	After you set the fields above, click Add to insert a new rule. Clicking Add saves your changes to the switch's run-time memory. The switch loses these changes if it is turned off or loses power, so use the Save link on the top navigation panel to save your changes to the non-volatile memory when you are done configuring.
Cancel	Click Cancel to reset the fields.
Clear	Click Clear to begin configuring this screen afresh.
Index	Click an index number to modify a static MAC address rule for a port.
Active	This field displays whether this static MAC address forwarding rule is active (Yes) or not (No). You may temporarily deactivate a rule without deleting it.
Name	This field displays the descriptive name for identification purposes for this static MAC address-forwarding rule.
MAC Address	This field displays the MAC address that will be forwarded and the VLAN identification number to which the MAC address belongs.
VID	This field displays the VLAN identification number.
Port	This field displays the port where the MAC address shown in the next field will be forwarded.

Table 20 Static MAC Forwarding (continued)

LABEL	DESCRIPTION
Delete	Click Delete to remove the selected entry from the summary table.
Cancel	Click Cancel to clear the Delete check boxes.

CHAPTER 10

Filtering

This chapter discusses MAC address port filtering.

10.1 Configure a Filtering Rule

Filtering means sifting traffic going through the switch based on the source MAC addresses and VLAN group (ID).

Click **Advanced Application** and **Filtering** in the navigation panel to display the screen as shown next.

Figure 46 Filtering

The following table describes the related labels in this screen.

Table 21 Filtering

LABEL	DESCRIPTION
Active	Make sure to select this check box to activate your rule. You may temporarily deactivate a rule without deleting it by deselecting this check box.
Name	Type a descriptive name (up to 32 printable ASCII characters) for this rule. This is for identification purpose only.
MAC	Type a MAC address in valid MAC address format, that is, six hexadecimal character pairs. Packets from this MAC address which also match the VLAN identification number you enter in the VID field are dropped by the switch.
VID	Type the VLAN group identification number. Packets which match the VLAN identification number and the MAC address you enter in the MAC field are dropped by the switch.

Table 21 Filtering (continued)

LABEL	DESCRIPTION
Add	Click Add to save your changes to the switch's run-time memory. The switch loses these changes if it is turned off or loses power, so use the Save link on the top navigation panel to save your changes to the non-volatile memory when you are done configuring.
Cancel	Click Cancel to reset the fields to your previous configuration.
Clear	Click Clear to clear the fields to the factory defaults.
Index	This field displays the index number of the rule. Click an index number to change the settings.
Active	This field displays Yes when the rule is activated and No when is it deactivated.
Name	This field displays the descriptive name for this rule. This is for identification purpose only.
MAC Address	This field displays the source MAC address with the VLAN identification number to which the MAC address belongs.
VID	This field displays the VLAN group identification number.
Delete	Check the rule(s) that you want to remove in the Delete column and then click the Delete button.
Cancel	Click Cancel to clear the selected checkbox(es) in the Delete column.

CHAPTER 11

Spanning Tree Protocol

This chapter introduces the Spanning Tree Protocol (STP).

11.1 STP/RSTP Overview

(R)STP detects and breaks network loops and provides backup links between switches, bridges or routers. It allows a switch to interact with other (R)STP -compliant switches in your network to ensure that only one path exists between any two stations on the network.

The switch uses IEEE 802.1w RSTP (Rapid Spanning Tree Protocol) that allows faster convergence of the spanning tree than STP (while also being backwards compatible with STP-only aware bridges). In RSTP, topology change information is directly propagated throughout the network from the device that generates the topology change. In STP, a longer delay is required as the device that causes a topology change first notifies the root bridge that then notifies the network. Both RSTP and STP flush unwanted learned addresses from the filtering database. In RSTP, the port states are Discarding, Learning, and Forwarding.

Note: In this user's guide, "STP" refers to both STP and RSTP.

11.1.1 STP Terminology

The root bridge is the base of the spanning tree; it is the bridge with the lowest identifier value (MAC address).

Path cost is the cost of transmitting a frame onto a LAN through that port. It is assigned according to the speed of the link to which a port is attached. The slower the media, the higher the cost.

Table 22 STP Path Costs

	LINK SPEED	RECOMMENDED VALUE	RECOMMENDED RANGE	ALLOWED RANGE
Path Cost	4Mbps	250	100 to 1000	1 to 65535
Path Cost	10Mbps	100	50 to 600	1 to 65535
Path Cost	16Mbps	62	40 to 400	1 to 65535
Path Cost	100Mbps	19	10 to 60	1 to 65535
Path Cost	1Gbps	4	3 to 10	1 to 65535
Path Cost	10Gbps	2	1 to 5	1 to 65535

On each bridge, the root port is the port through which this bridge communicates with the root. It is the port on this switch with the lowest path cost to the root (the root path cost). If there is no root port, then this switch has been accepted as the root bridge of the spanning tree network.

For each LAN segment, a designated bridge is selected. This bridge has the lowest cost to the root among the bridges connected to the LAN.

11.1.2 How STP Works

After a bridge determines the lowest cost-spanning tree with STP, it enables the root port and the ports that are the designated ports for connected LANs, and disables all other ports that participate in STP. Network packets are therefore only forwarded between enabled ports, eliminating any possible network loops.

STP-aware switches exchange Bridge Protocol Data Units (BPDUs) periodically. When the bridged LAN topology changes, a new spanning tree is constructed.

Once a stable network topology has been established, all bridges listen for Hello BPDUs (Bridge Protocol Data Units) transmitted from the root bridge. If a bridge does not get a Hello BPDUs after a predefined interval (Max Age), the bridge assumes that the link to the root bridge is down. This bridge then initiates negotiations with other bridges to reconfigure the network to re-establish a valid network topology.

11.1.3 STP Port States

STP assigns five port states to eliminate packet looping. A bridge port is not allowed to go directly from blocking state to forwarding state so as to eliminate transient loops.

Table 23 STP Port States

PORT STATE	DESCRIPTION
Disabled	STP is disabled (default).
Blocking	Only configuration and management BPDUs are received and processed.
Listening	All BPDUs are received and processed.
Learning	All BPDUs are received and processed. Information frames are submitted to the learning process but not forwarded.
Forwarding	All BPDUs are received and processed. All information frames are received and forwarded.

11.2 Rapid Spanning Tree Protocol Status

Use this screen to view RSTP settings, see [Section 11.1 on page 101](#) for more information on RSTP. Click **Spanning Tree Protocol** in the **Advanced Application, Spanning Tree Protocol** screen.

Figure 47 Spanning Tree Protocol: Status

Rapid Spanning Tree Protocol Status		Configuration
Rapid Spanning Tree Protocol: Down		
Bridge	Root	Our Bridge
Bridge ID	0000-000000000000	0000-000000000000
Hello Time (second)	0	0
Max Age (second)	0	0
Forwarding Delay (second)	0	0
Cost to Bridge	0	
Port ID	0x0000	
Topology Changed Times		0
Time Since Last Change		0:00:00

The following table describes the labels in this screen.

Table 24 Spanning Tree Protocol: Status

LABEL	DESCRIPTION
Rapid Spanning Tree Protocol	This field displays Running if STP is activated. Otherwise, it displays Down .
Configuration	Click Configuration to configure STP settings. Refer to Section 11.3 on page 104 .
Bridge	Root refers to the base of the spanning tree (the root bridge). Our Bridge is this switch. This switch may also be the root bridge.
Bridge ID	This is the unique identifier for this bridge, consisting of bridge priority plus MAC address. This ID is the same for Root and Our Bridge if the switch is the root switch.
Hello Time (second)	This is the time interval (in seconds) at which the root switch transmits a configuration message. The root bridge determines Hello Time , Max Age and Forwarding Delay .
Max Age (second)	This is the maximum time (in seconds) a switch can wait without receiving a configuration message before attempting to reconfigure.
Forwarding Delay (second)	This is the time (in seconds) the root switch will wait before changing states (that is, listening to learning to forwarding).
Cost to Bridge	This is the path cost from the root port on this switch to the root switch.
Port ID	This is the priority and number of the port on the switch through which this switch must communicate with the root of the Spanning Tree.
Topology Changed Times	This is the number of times the spanning tree has been reconfigured.
Time Since Last Change	This is the time since the spanning tree was last reconfigured.

11.3 Configure Rapid Spanning Tree Protocol

Use this screen to configure RSTP settings, see [Section 11.1 on page 101](#) for more information on RSTP. Click the **Configuration** link in the **Rapid Spanning Tree Protocol Status** screen as shown next.

Figure 48 Spanning Tree Protocol: Configuration

Port	Active	Priority	Path Cost
*	<input type="checkbox"/>		
1	<input type="checkbox"/>	128	19
2	<input type="checkbox"/>	128	19
3	<input type="checkbox"/>	128	19
4	<input type="checkbox"/>	128	19
5	<input type="checkbox"/>	128	19
6	<input type="checkbox"/>	128	19
7	<input type="checkbox"/>	128	19
8	<input type="checkbox"/>	128	19
9	<input type="checkbox"/>	128	4

The following table describes the labels in this screen.

Table 25 Spanning Tree Protocol: Configuration

LABEL	DESCRIPTION
Status	Click Status to display the Rapid Spanning Tree Protocol Status screen (see Figure 47 on page 103).
Active	Select this check box to activate an STP tree. Clear this checkbox to disable an STP tree.
Bridge Priority	Bridge priority is used in determining the root switch, root port and designated port. The switch with the highest priority (lowest numeric value) becomes the STP root switch. If all switches have the same priority, the switch with the lowest MAC address will then become the root switch. Select a value from the drop-down list box. The lower the numeric value you assign, the higher the priority for this bridge. Bridge Priority determines the root bridge, which in turn determines Hello Time, Max Age and Forwarding Delay.
Hello Time	This is the time interval in seconds between BPDU (Bridge Protocol Data Units) configuration message generations by the root switch. The allowed range is 1 to 10 seconds.

Table 25 Spanning Tree Protocol: Configuration (continued)

LABEL	DESCRIPTION
Max Age	This is the maximum time (in seconds) a switch can wait without receiving a BPDU before attempting to reconfigure. All switch ports (except for designated ports) should receive BPDUs at regular intervals. Any port that ages out STP information (provided in the last BPDU) becomes the designated port for the attached LAN. If it is a root port, a new root port is selected from among the switch ports attached to the network. The allowed range is 6 to 40 seconds.
Forwarding Delay	This is the maximum time (in seconds) a switch will wait before changing states. This delay is required because every switch must receive information about topology changes before it starts to forward frames. In addition, each port needs time to listen for conflicting information that would make it return to a blocking state; otherwise, temporary data loops might result. The allowed range is 4 to 30 seconds. As a general rule: Note: $2 * (\text{Forward Delay} - 1) \geq \text{Max Age} \geq 2 * (\text{Hello Time} + 1)$
Port	This field displays the port number.
*	Settings in this row apply to all ports. Use this row only if you want to make some settings the same for all ports. Use this row first to set the common settings and then make adjustments on a port-by-port basis. Note: Changes in this row are copied to all the ports as soon as you make them.
Active	Select this check box to activate STP on this port.
Priority	Configure the priority for each port here. Priority decides which port should be disabled when more than one port forms a loop in a switch. Ports with a higher priority numeric value are disabled first. The allowed range is between 0 and 255 and the default value is 128.
Path Cost	Path cost is the cost of transmitting a frame on to a LAN through that port. It is assigned according to the speed of the bridge. The slower the media, the higher the cost - see Table 22 on page 101 for more information.
Apply	Click Apply to save your changes to the switch's run-time memory. The switch loses these changes if it is turned off or loses power, so use the Save link on the top navigation panel to save your changes to the non-volatile memory when you are done configuring.
Cancel	Click Cancel to reset the fields.

CHAPTER 12

Bandwidth Control

This chapter shows you how you can cap the maximum bandwidth using the **Bandwidth Control** screen.

12.1 Bandwidth Control Setup

Bandwidth control means defining a maximum allowable bandwidth for incoming and/or outgoing traffic flows on a port.

Click **Advanced Application** and then **Bandwidth Control** in the navigation panel to bring up the screen as shown next.

Figure 49 Bandwidth Control

Port	Active	Ingress Rate	Active	Egress Rate
*	<input type="checkbox"/>	<input type="text"/> Kbps	<input type="checkbox"/>	<input type="text"/> Kbps
1	<input type="checkbox"/>	<input type="text"/> 64 Kbps	<input type="checkbox"/>	<input type="text"/> 64 Kbps
2	<input type="checkbox"/>	<input type="text"/> 64 Kbps	<input type="checkbox"/>	<input type="text"/> 64 Kbps
3	<input type="checkbox"/>	<input type="text"/> 64 Kbps	<input type="checkbox"/>	<input type="text"/> 64 Kbps
4	<input type="checkbox"/>	<input type="text"/> 64 Kbps	<input type="checkbox"/>	<input type="text"/> 64 Kbps
5	<input type="checkbox"/>	<input type="text"/> 64 Kbps	<input type="checkbox"/>	<input type="text"/> 64 Kbps
6	<input type="checkbox"/>	<input type="text"/> 64 Kbps	<input type="checkbox"/>	<input type="text"/> 64 Kbps
7	<input type="checkbox"/>	<input type="text"/> 64 Kbps	<input type="checkbox"/>	<input type="text"/> 64 Kbps
8	<input type="checkbox"/>	<input type="text"/> 64 Kbps	<input type="checkbox"/>	<input type="text"/> 64 Kbps
9	<input type="checkbox"/>	<input type="text"/> 64 Kbps	<input type="checkbox"/>	<input type="text"/> 64 Kbps

Apply Cancel

The following table describes the related labels in this screen.

Table 26 Bandwidth Control

LABEL	DESCRIPTION
Active	Select this check box to enable bandwidth control on the switch.
Port	This field displays the port number.

Table 26 Bandwidth Control (continued)

LABEL	DESCRIPTION
*	<p>Settings in this row apply to all ports.</p> <p>Use this row only if you want to make some settings the same for all ports. Use this row first to set the common settings and then make adjustments on a port-by-port basis.</p> <p>Note: Changes in this row are copied to all the ports as soon as you make them.</p>
Active	Make sure to select this check box to activate ingress limits on a port.
Ingress Rate	<p>Specify the maximum bandwidth allowed in Kilobits per second (Kbps) for the incoming traffic flow on a port.</p> <p>If you enter a number between 64 and 1728, the switch automatically rounds the number down to the nearest multiple of 64.</p> <p>If you enter a number between 1729 and 1999, the rate is fixed at 1792.</p> <p>If you enter a number between 2000 and 103999, the switch rounds the number down to the nearest multiple of 1000.</p> <p>On a Gigabit Ethernet/ Mini-GBIC port, the switch rounds a number down to the nearest multiple of 8000 for a number between 104000 and 1000000.</p>
Active	Make sure to select this check box to activate egress limits on a port.
Egress Rate	<p>Specify the maximum bandwidth allowed in Kilobits per second (Kbps) for the outgoing traffic flow on a port.</p> <p>If you enter a number between 64 and 1728, the switch automatically rounds the number down to the nearest multiple of 64.</p> <p>If you enter a number between 1729 and 1999, the rate is fixed at 1792.</p> <p>If you enter a number between 2000 and 103999, the switch rounds the number down to the nearest multiple of 1000.</p> <p>On a Gigabit Ethernet/ Mini-GBIC port, the switch rounds a number down to the nearest multiple of 8000 for a number between 104000 and 1000000.</p>
Apply	Click Apply to save your changes to the switch's run-time memory. The switch loses these changes if it is turned off or loses power, so use the Save link on the top navigation panel to save your changes to the non-volatile memory when you are done configuring.
Cancel	Click Cancel to reset the fields to your previous configuration.

CHAPTER 13

Broadcast Storm Control

This chapter introduces and shows you how to configure the broadcast storm control feature.

13.1 Broadcast Storm Control Setup

Broadcast storm control limits the number of broadcast frames that can be stored in the switch buffer or sent out from the switch. Broadcast frames that arrive when the buffer is full are discarded. Enable this feature to reduce broadcast traffic coming into your network.

Click **Advanced Application, Broadcast Storm Control** in the navigation panel to display the screen as shown next.

Figure 50 Broadcast Storm Control

Port	Active	Rate
*	<input type="checkbox"/>	<input type="text"/> Kbps
1	<input type="checkbox"/>	64 Kbps
2	<input type="checkbox"/>	64 Kbps
3	<input type="checkbox"/>	64 Kbps
4	<input type="checkbox"/>	64 Kbps
5	<input type="checkbox"/>	64 Kbps
6	<input type="checkbox"/>	64 Kbps
7	<input type="checkbox"/>	64 Kbps
8	<input type="checkbox"/>	64 Kbps
9	<input type="checkbox"/>	64 Kbps

The following table describes the labels in this screen.

Table 27 Broadcast Storm Control

LABEL	DESCRIPTION
Active	Select this check box to enable broadcast storm control on the switch. Clear this check box to disable the feature.
Port	This field displays a port number.

Table 27 Broadcast Storm Control (continued)

LABEL	DESCRIPTION
*	<p>Settings in this row apply to all ports.</p> <p>Use this row only if you want to make some settings the same for all ports. Use this row first to set the common settings and then make adjustments on a port-by-port basis.</p> <p>Note: Changes in this row are copied to all the ports as soon as you make them.</p>
Active	Select this check box to enable broadcast storm control on the port. Clear this check box to disable the feature.
Rate	<p>Specify the traffic a port receives in Kilobits per second (Kbps).</p> <p>If you enter a number between 64 and 1728, the switch automatically rounds the number down to the nearest multiple of 64.</p> <p>If you enter a number between 1729 and 1999, the rate is fixed at 1792.</p> <p>If you enter a number between 2000 and 103999, the switch rounds the number down to the nearest multiple of 1000.</p> <p>On a Gigabit Ethernet/ Mini-GBIC port, the switch rounds a number down to the nearest multiple of 8000 for a number between 104000 and 1000000.</p>
Apply	Click Apply to save your changes to the switch's run-time memory. The switch loses these changes if it is turned off or loses power, so use the Save link on the top navigation panel to save your changes to the non-volatile memory when you are done configuring.
Cancel	Click Cancel to begin configuring this screen afresh.

CHAPTER 14

Mirroring

This chapter discusses the Mirror setup screens.

14.1 Port Mirroring Setup

Port mirroring allows you to copy a traffic flow to a monitor port (the port you copy the traffic to) in order that you can examine the traffic from the mirror port without interference.

Click **Advanced Application, Mirroring** in the navigation panel to display the **Mirroring** screen. Use this screen to select a monitor port and specify the traffic flow to be copied to the monitor port.

Figure 51 Mirroring

Port	Mirrored	Direction
*	<input type="checkbox"/>	Ingress
1	<input type="checkbox"/>	Ingress
2	<input type="checkbox"/>	Ingress
3	<input type="checkbox"/>	Ingress
4	<input type="checkbox"/>	Ingress
5	<input type="checkbox"/>	Ingress
6	<input type="checkbox"/>	Ingress
7	<input type="checkbox"/>	Ingress
8	<input type="checkbox"/>	Ingress
9	<input type="checkbox"/>	Ingress

The following table describes the labels in this screen.

Table 28 Mirroring

LABEL	DESCRIPTION
Active	Clear this check box to deactivate port mirroring on the switch.
Monitor Port	The monitor port is the port you copy the traffic to in order to examine it in more detail without interfering with the traffic flow on the original port(s). Select this port from this drop-down list box.

Table 28 Mirroring (continued)

LABEL	DESCRIPTION
Ingress	<p>You can specify to copy all incoming traffic or traffic to/from a specified MAC address. Select All to copy all incoming traffic from the mirrored port(s).</p> <p>Select Destination MAC to copy incoming traffic to a specified MAC address on the mirrored port(s). Enter the destination MAC address in the fields provided.</p> <p>Select Source MAC to copy incoming traffic from a specified MAC address on the mirrored port(s). Enter the source MAC address in the fields provided.</p>
Egress	<p>You can specify to copy all outgoing traffic or traffic to/from a specified MAC address. Select All to copy all outgoing traffic from the mirrored port(s).</p> <p>Select Destination MAC to copy outgoing traffic to a specified MAC address on the mirrored port(s). Enter the destination MAC address in the fields provided.</p> <p>Select Source MAC to copy outgoing traffic from a specified MAC address on the mirrored port(s). Enter the source MAC address in the fields provided.</p>
Port	This field displays the port number.
*	<p>Settings in this row apply to all ports.</p> <p>Use this row only if you want to make some settings the same for all ports. Use this row first to set the common settings and then make adjustments on a port-by-port basis.</p> <p>Note: Changes in this row are copied to all the ports as soon as you make them.</p>
Mirrored	Select this option to mirror the traffic on a port.
Direction	Specify the direction of the traffic to mirror. Choices are Egress (outgoing), Ingress (incoming) and Both .
Apply	Click Apply to save your changes to the switch's run-time memory. The switch loses these changes if it is turned off or loses power, so use the Save link on the top navigation panel to save your changes to the non-volatile memory when you are done configuring.
Cancel	Click Cancel to start configuring the screen again.

CHAPTER 15

Link Aggregation

This chapter shows you how to logically aggregate physical links to form one logical, higher-bandwidth link.

15.1 Link Aggregation Overview

Link aggregation (trunking) is the grouping of physical ports into one logical higher-capacity link. You may want to trunk ports if for example, it is cheaper to use multiple lower-speed links than to under-utilize a high-speed, but more costly, single-port link.

However, the more ports you aggregate then the fewer available ports you have. A trunk group is one logical link containing multiple ports.

The beginning port of each trunk group must be physically connected to form a trunk group.

15.2 Dynamic Link Aggregation

The switch adheres to the IEEE 802.3ad standard for static and dynamic (LACP) port trunking.

The switch supports the link aggregation IEEE802.3ad standard. This standard describes the Link Aggregate Control Protocol (LACP), which is a protocol that dynamically creates and manages trunk groups.

When you enable LACP link aggregation on a port, the port can automatically negotiate with the ports at the remote end of a link to establish trunk groups. LACP also allows port redundancy, that is, if an operational port fails, then one of the “standby” ports become operational without user intervention. Please note that:

- You must connect all ports point-to-point to the same Ethernet switch and configure the ports for LACP trunking.
- LACP only works on full-duplex links.
- All ports in the same trunk group must have the same media type, speed, duplex mode and flow control settings.

Configure trunk groups or LACP before you connect the Ethernet switch to avoid causing network topology loops.

15.2.1 Link Aggregation ID

LACP aggregation ID consists of the following information¹:

Table 29 Link Aggregation ID: Local Switch

SYSTEM PRIORITY	MAC ADDRESS	KEY	PORT PRIORITY	PORT NUMBER
0000	00-00-00-00-00	0000	00	0000

Table 30 Link Aggregation ID: Peer Switch

SYSTEM PRIORITY	MAC ADDRESS	KEY	PORT PRIORITY	PORT NUMBER
0000	00-00-00-00-00	0000	00	0000

15.3 Link Aggregation Control Protocol Status

Click **Advanced Application**, **Link Aggregation** in the navigation panel. The **Link Aggregation Control Protocol Status** screen displays by default. See [Section 15.1 on page 113](#) for more information.

Figure 52 Link Aggregation Control Protocol Status

Index	Aggregator ID	Enabled Ports	Synchronized Ports
1	[(0000,00-00-00-00-00-00,0000,00,0000)]	-	-
2	[(0000,00-00-00-00-00-00,0000,00,0000)]	-	-

The following table describes the labels in this screen.

Table 31 Link Aggregation Control Protocol Status

LABEL	DESCRIPTION
Index	This field displays the trunk ID to identify a trunk group, that is, one logical link containing multiple ports.
Aggregator ID	Link Aggregator ID consists of system priority, MAC address, key, port priority and port number. Refer to Section 15.2.1 on page 114 for more information on this field.
Enabled Port	These are the ports you have configured in the Link Aggregation screen to be in the trunk group.
Synchronized Ports	These are the ports that are currently transmitting data as one logical link in this trunk group.

1. Port Priority and Port Number are 0 as it is the aggregator ID for the trunk group, not the individual port.

15.4 Link Aggregation Setup

Click **Configuration** in the **Link Aggregation Control Protocol Status** screen to display the screen shown next. See [Section 15.1 on page 113](#) for more information on link aggregation.

Figure 53 Link Aggregation: Configuration

The following table describes the labels in this screen.

Table 32 Link Aggregation Control Protocol: Configuration

LABEL	DESCRIPTION
Link Aggregation Control Protocol	
Active	Select this checkbox to enable Link Aggregation Control Protocol (LACP).
System Priority	LACP system priority is a number between 1 and 65,535. The switch with the lowest system priority (and lowest port number if system priority is the same) becomes the LACP “server”. The LACP “server” controls the operation of LACP setup. Enter a number to set the priority of an active port using Link Aggregate Control Protocol (LACP). The smaller the number, the higher the priority level.
Group ID	The field identifies the link aggregation group, that is, one logical link containing multiple ports
Active	Select this option to activate a trunk group.
Dynamic (LACP)	Select this check box to enable LACP for a trunk.
Port	This field displays the port number.

Table 32 Link Aggregation Control Protocol: Configuration (continued)

LABEL	DESCRIPTION
*	<p>Settings in this row apply to all ports.</p> <p>Use this row only if you want to make some settings the same for all ports. Use this row first to set the common settings and then make adjustments on a port-by-port basis.</p> <p>Note: Changes in this row are copied to all the ports as soon as you make them.</p>
Group	Select the trunk group to which a port belongs.
LACP Timeout	Timeout is the time interval between the individual port exchanges of LACP packets in order to check that the peer port in the trunk group is still up. If a port does not respond after three tries, then it is deemed to be “down” and is removed from the trunk. Set a short timeout (one second) for busy trunked links to ensure that disabled ports are removed from the trunk group as soon as possible. Select either 1 second or 30 seconds.
Apply	Click Apply to save your changes to the switch's run-time memory. The switch loses these changes if it is turned off or loses power, so use the Save link on the top navigation panel to save your changes to the non-volatile memory when you are done configuring.
Cancel	Click Cancel to begin configuring this screen afresh.

CHAPTER 16

Port Authentication

This chapter describes the 802.1x authentication method and RADIUS server connection setup. See [Section 32.9 on page 228](#) for information on how to use the commands to configure additional Radius server settings as well as multiple Radius server configuration.

16.1 Port Authentication Overview

IEEE 802.1x is an extended authentication protocol² that allows support of RADIUS (Remote Authentication Dial In User Service, RFC 2138, 2139) for centralized user profile and accounting management on a network RADIUS server.

16.1.1 RADIUS

RADIUS (Remote Authentication Dial-In User Service) authentication is a popular protocol used to authenticate users by means of an external server instead of (or in addition to) an internal device user database that is limited to the memory capacity of the device. In essence, RADIUS authentication allows you to validate an unlimited number of users from a central location.

Figure 54 RADIUS Server



16.1.1.1 Vendor Specific Attribute

A Vendor Specific Attribute (VSA) is an attribute-value pair that is sent between a RADIUS server and the switch. Configure VSAs on the RADIUS server to set the switch to perform the following actions on an authenticated user:

- Limit bandwidth on incoming or outgoing traffic
- Assign account privilege levels

Note: Refer to the documentation that comes with your RADIUS server on how to configure a VSA.

2. At the time of writing, only Windows XP of the Microsoft operating systems supports it. See the Microsoft web site for information on other Windows operating system support. For other operating systems, see its documentation. If your operating system does not support 802.1x, then you may need to install 802.1x client software.

The following table describes the VSAs supported on the switch.

Table 33 Supported VSA

FUNCTION	ATTRIBUTE
Ingress Bandwidth Assignment	Vendor-Id = 890 (ZyXEL) Vendor-Type = 1 Vendor-data = ingress rate (decimal)
Egress Bandwidth Assignment	Vendor-Id = 890 (ZyXEL) Vendor-Type = 2 Vendor-data = egress rate (decimal)
Privilege Assignment	Vendor-ID = 890 (ZyXEL) Vendor-Type = 3 Vendor-Data = " shell:priv-lvl=N " or Vendor-ID = 9 (CISCO) Vendor-Type = 1 (CISCO-AVPAIR) Vendor-Data = " shell:priv-lvl=N " where N is a privilege level (from 0 to 14). Note: If you set the privilege level of a login account differently on the RADIUS server(s) and the switch, the user is assigned a privilege level from the database (RADIUS or local) the switch uses first for user authentication.

16.1.1.2 Tunnel Protocol Attribute

You can configure tunnel protocol attributes on the RADIUS server to assign a port on the switch to a VLAN (fixed, untagged). This will also set the port's VID. Refer to RFC 3580 for more information.

Table 34 Supported Tunnel Protocol Attribute

FUNCTION	ATTRIBUTE
VLAN Assignment	Tunnel-Type = VLAN (13) Tunnel-Medium-Type = 802 (6) Tunnel-Private-Group-ID = VLAN ID Note: You must also create a VLAN with the specified VID on the switch.

16.2 Port Authentication Configuration

To enable port authentication, first activate IEEE802.1x security (both on the switch and the port(s)) then configure the RADIUS server settings.

Click **Advanced Application, Port Authentication** in the navigation panel to display the screen as shown.

Figure 55 Port Authentication

16.2.1 Configuring RADIUS Server Settings

From the **Port Authentication** screen, click **RADIUS** to display the configuration screen as shown. You can configure two RADIUS servers on the switch. Use this screen to configure the first RADIUS server.

Note: Use the CLI to configure the first or second RADIUS server.

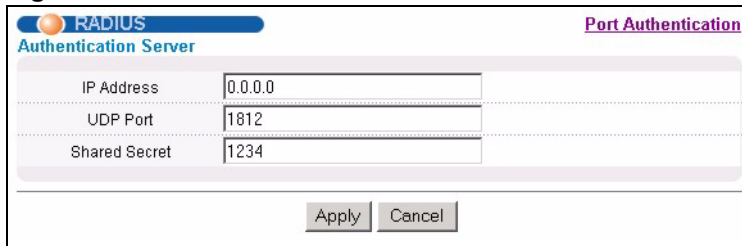
Figure 56 Port Authentication: RADIUS

The following table describes the labels in this screen.

Table 35 Port Authentication: RADIUS

LABEL	DESCRIPTION
Authentication Server	
IP Address	Enter the IP address of the external RADIUS server in dotted decimal notation.
UDP Port	The default port of the RADIUS server for authentication is 1812 . You need not change this value unless your network administrator instructs you to do so.
Shared Secret	Specify a password (up to 32 alphanumeric characters) as the key to be shared between the external RADIUS server and the switch. This key is not sent over the network. This key must be the same on the external RADIUS server and the switch.
Apply	Click Apply to save your changes to the switch's run-time memory. The switch loses these changes if it is turned off or loses power, so use the Save link on the top navigation panel to save your changes to the non-volatile memory when you are done configuring.
Cancel	Click Cancel to begin configuring this screen afresh.

16.2.2 Activate IEEE 802.1x Security

Use this screen to activate IEEE 802.1x security. From the **Port Authentication** screen, display the configuration screen as shown.

Figure 57 Port Authentication: 802.1x

Port	Active	Reauthentication	Reauthentication Timer
*	<input type="checkbox"/>	On	<input type="text"/> seconds
1	<input type="checkbox"/>	On	3600 seconds
2	<input type="checkbox"/>	On	3600 seconds
3	<input type="checkbox"/>	On	3600 seconds
4	<input type="checkbox"/>	On	3600 seconds
5	<input type="checkbox"/>	On	3600 seconds
6	<input type="checkbox"/>	On	3600 seconds
7	<input type="checkbox"/>	On	3600 seconds
8	<input type="checkbox"/>	On	3600 seconds
9	<input type="checkbox"/>	On	3600 seconds

The following table describes the labels in this screen.

Table 36 Port Authentication: 802.1x

LABEL	DESCRIPTION
Active	Select this check box to permit 802.1x authentication on the switch. Note: You must first enable 802.1x authentication on the switch before configuring it on each port.
Port	This field displays a port number.
*	Settings in this row apply to all ports. Use this row only if you want to make some settings the same for all ports. Use this row first to set the common settings and then make adjustments on a port-by-port basis. Note: Changes in this row are copied to all the ports as soon as you make them.
Active	Select this checkbox to permit 802.1x authentication on this port. You must first allow 802.1x authentication on the switch before configuring it on each port.
Reauthentication	Specify if a subscriber has to periodically re-enter his or her username and password to stay connected to the port.
Reauthentication Timer	Specify how often a client has to re-enter his or her username and password to stay connected to the port.
Apply	Click Apply to save your changes to the switch's run-time memory. The switch loses these changes if it is turned off or loses power, so use the Save link on the top navigation panel to save your changes to the non-volatile memory when you are done configuring.
Cancel	Click Cancel to begin configuring this screen afresh.

CHAPTER 17

Port Security

This chapter shows you how to set up port security.

17.1 Port Security Overview

Port security allows only packets with dynamically learned MAC addresses and/or configured static MAC addresses to pass through a port on the switch. See [Chapter 9 on page 95](#) for information on configuring static MAC address forwarding.

For maximum port security, enable this feature, disable MAC address learning and configure static MAC address(es) for a port.

Functionally the switch allows for three possible outcomes with port security. You can configure the ports to:

- Forward all packets and learn all MAC addresses.
- Drop all packets from unknown MAC addresses and do not learn MAC addresses.
- Drop all packets from unknown MAC addresses and learn a limited number of MAC addresses.

Note: The ES-2108 Series supports five possible configurations for port security. See [Section 17.3 on page 123](#) for supported configurations and an example.

17.2 Port Security Setup

Click **Advanced Application, Port Security** in the navigation panel to display the screen as shown.

Figure 58 Port Security

Port	Active	Address Learning	Limited Number of Learned MAC Address
*	<input type="checkbox"/>	<input checked="" type="checkbox"/>	<input type="text"/>
1	<input type="checkbox"/>	<input checked="" type="checkbox"/>	<input type="text" value="0"/>
2	<input type="checkbox"/>	<input checked="" type="checkbox"/>	<input type="text" value="0"/>
3	<input type="checkbox"/>	<input checked="" type="checkbox"/>	<input type="text" value="0"/>
4	<input type="checkbox"/>	<input checked="" type="checkbox"/>	<input type="text" value="0"/>
5	<input type="checkbox"/>	<input checked="" type="checkbox"/>	<input type="text" value="0"/>
6	<input type="checkbox"/>	<input checked="" type="checkbox"/>	<input type="text" value="0"/>
7	<input type="checkbox"/>	<input checked="" type="checkbox"/>	<input type="text" value="0"/>
8	<input type="checkbox"/>	<input checked="" type="checkbox"/>	<input type="text" value="0"/>

The following table describes the labels in this screen.

Table 37 Port Security

LABEL	DESCRIPTION
Active	Select this check box to enable the port security feature on the switch.
Port	This field displays a port number.
*	Settings in this row apply to all ports. Use this row only if you want to make some settings the same for all ports. Use this row first to set the common settings and then make adjustments on a port-by-port basis. Note: Changes in this row are copied to all the ports as soon as you make them.
Active	Select this check box to enable the port security feature on this port. The switch forwards packets whose MAC address(es) is in the MAC address table on this port. Packets with no matching MAC address(es) are dropped. Clear this check box to disable the port security feature. The switch forwards all packets on this port.
Address Learning	MAC address learning reduces outgoing broadcast traffic. For MAC address learning to occur on a port, the port itself must be active (activated in the Basic Settings , Port Setup screen) with address learning enabled.
Limited Number of Learned MAC Address	Use this field to limit the number of (dynamic) MAC addresses that may be learned on a port. For example, if you set this field to "5" on port 2, then only the devices with these five learned MAC addresses may access port 2 at any one time. A sixth device would have to wait until one of the five learned MAC addresses aged out. MAC address aging out time can be set in the Switch Setup screen. The valid range is from "0" to "8192". "0" means that the limiting of learned addresses is disabled.
Apply	Click Apply to save your changes to the switch's run-time memory. The switch loses these changes if it is turned off or loses power, so use the Save link on the top navigation panel to save your changes to the non-volatile memory when you are done configuring.
Cancel	Click Cancel to begin configuring this screen afresh.

17.3 Port Security Example

The following example demonstrates the various settings and results associated with different port security configurations. Ports 1 to 5 are configured to:

- Port 1 - Forward all packets and learn all MAC addresses.
- Port 2 - Forward all packets and learn all MAC addresses.
- Port 3 - Drop all packets from unknown MAC addresses and do not learn MAC addresses.
- Port 4 - Drop all packets from unknown MAC addresses and do not learn MAC addresses.
- Port 5 - Drop all packets from unknown MAC addresses but forward packets from up to 100 learned MAC addresses.

Figure 59 Port Security Example

Port	Active	Address Learning	Limited Number of Learned MAC Address
*	<input type="checkbox"/>	<input checked="" type="checkbox"/>	
1	<input type="checkbox"/>	<input checked="" type="checkbox"/>	0
2	<input checked="" type="checkbox"/>	<input checked="" type="checkbox"/>	0
3	<input checked="" type="checkbox"/>	<input type="checkbox"/>	0
4	<input checked="" type="checkbox"/>	<input type="checkbox"/>	100
5	<input checked="" type="checkbox"/>	<input checked="" type="checkbox"/>	100
6	<input type="checkbox"/>	<input checked="" type="checkbox"/>	0
7	<input type="checkbox"/>	<input checked="" type="checkbox"/>	0
8	<input type="checkbox"/>	<input checked="" type="checkbox"/>	0

The following table is a summary of configuration and results of this example.

Table 38 Port Security Example

PORT	SETTINGS			RESULT
	ACTIVATE PORT SECURITY	ACTIVATE ADDRESS LEARNING	LIMIT NO. OF LEARNED MAC ADDRESSES	
1		X	0 (disables limits)	Forward all packets, learn all MAC addresses.
2	X	X	0 (disables limits)	Forward all packets, learn all MAC addresses.

Table 38 Port Security Example (continued)

PORT	SETTINGS			RESULT
	ACTIVATE PORT SECURITY	ACTIVATE ADDRESS LEARNING	LIMIT NO. OF LEARNED MAC ADDRESSES	
3	X		0 (disables limits)	Drop all packets from unknown MAC addresses, do not learn MAC addresses.
4	X		100	Drop all packets from unknown MAC addresses, do not learn MAC addresses.
5	X	X	100	Drop packets from unknown MAC addresses, learn up to 100 MAC addresses.

CHAPTER 18

Queuing Method

This chapter introduces the queuing methods supported.

18.1 Queuing Method Overview

Queuing is used to help solve performance degradation when there is network congestion. Use the **Queuing Method** screen to configure queuing algorithms for outgoing traffic. See also **Priority Queue Assignment in Switch Setup** and **802.1p Priority in Port Setup** for related information.

Queuing algorithms allow switches to maintain separate queues for packets from each individual source or flow and prevent a source from monopolizing the bandwidth.

Table 39 Physical Queue Priority

QUEUE	PRIORITY
Q3	4 (highest)
Q2	3
Q1	2
Q0	1 (lowest)

18.1.1 Strict Priority Queuing (SPQ)

Strict Priority Queuing (SPQ) services queues based on priority only. As traffic comes into the switch, traffic on the highest priority queue, Q3 is transmitted first. When that queue empties, traffic on the next highest-priority queue, Q2 is transmitted until Q2 empties, and then traffic is transmitted on Q1 and so on. If higher priority queues never empty, then traffic on lower priority queues never gets sent. SPQ does not automatically adapt to changing network requirements.

18.1.2 Weighted Round Robin Scheduling (WRR)

Round Robin Scheduling services queues on a rotating basis and is activated only when a port has more traffic than it can handle. A queue is given an amount of bandwidth irrespective of the incoming traffic on that port. This queue then moves to the back of the list. The next queue is given an equal amount of bandwidth, and then moves to the end of the list; and so on, depending on the number of queues being used. This works in a looping fashion until a queue is empty.

Weighted Round Robin Scheduling (WRR) uses the same algorithm as round robin scheduling, but services queues based on their priority and queue weight (the number you configure in the queue **Weight** field) rather than a fixed amount of bandwidth. WRR is activated only when a port has more traffic than it can handle. Queues with larger weights get more service than queues with smaller weights. This queuing mechanism is highly efficient in that it divides any available bandwidth across the different traffic queues and returns to queues that have not yet emptied.

18.2 Configuring Queuing Method

Click **Advanced Application, Queuing Method** in the navigation panel.

Figure 60 Queuing Method

The following table describes the labels in this screen.

Table 40 Queuing Method

LABEL	DESCRIPTION
Method	Select Strictly Priority or Weighted Round Robin Scheduling . Strict Priority Queuing (SPQ) services queues based on priority only. When the highest priority queue empties, traffic on the next highest-priority queue begins. Q3 has the highest priority and Q0 the lowest. The default queuing method is Strictly Priority . Weighted Round Robin Scheduling (WRR) services queues on a rotating basis based on their queue weight (the number you configure in the queue Weight field). Queues with larger weights get more service than queues with smaller weights. Note: When you select SPQ , it applies to Q3 only (with priority over all other queues). Q0 ~ Q2 will use Weighted Round Robin .
Weight	When you select Weighted Round Robin Scheduling , use the drop-down list boxes to choose queue weights (1-15). Bandwidth is divided across the different traffic queues according to their weights.
Apply	Click Apply to save your changes to the switch's run-time memory. The switch loses these changes if it is turned off or loses power, so use the Save link on the top navigation panel to save your changes to the non-volatile memory when you are done configuring.
Cancel	Click Cancel to begin configuring this screen afresh.

CHAPTER 19

Multicast

This chapter shows you how to configure various multicast features.

19.1 Multicast Overview

Traditionally, IP packets are transmitted in one of either two ways - Unicast (1 sender to 1 recipient) or Broadcast (1 sender to everybody on the network). Multicast delivers IP packets to just a group of hosts on the network.

IGMP (Internet Group Multicast Protocol) is a network-layer protocol used to establish membership in a multicast group - it is not used to carry user data. Refer to RFC 1112 and RFC 2236 for information on IGMP versions 1 and 2 respectively.

19.1.1 IP Multicast Addresses

In IPv4, a multicast address allows a device to send packets to a specific group of hosts (multicast group) in a different subnetwork. A multicast IP address represents a traffic receiving group, not individual receiving devices. IP addresses in the Class D range (224.0.0.0 to 239.255.255.255) are used for IP multicasting. Certain IP multicast numbers are reserved by IANA for special purposes (see the IANA web site for more information).

19.1.2 IGMP Filtering

With the IGMP filtering feature, you can control which IGMP groups a subscriber on a port can join. This allows you to control the distribution of multicast services (such as content information distribution) based on service plans and types of subscription.

You can set the switch to filter the multicast group join reports on a per-port basis by configuring an IGMP filtering profile and associating the profile to a port.

19.1.3 IGMP Snooping

A switch can passively snoop on IGMP Query, Report and Leave (IGMP version 2) packets transferred between IP multicast routers/switches and IP multicast hosts to learn the IP multicast group membership. It checks IGMP packets passing through it, picks out the group registration information, and configures multicasting accordingly. IGMP snooping allows the switch to learn multicast groups without you having to manually configure them.

The switch forwards multicast traffic destined for multicast groups (that it has learned from IGMP snooping or that you have manually configured) to ports that are members of that group. IGMP snooping generates no additional network traffic, allowing you to significantly reduce multicast traffic passing through your switch.

19.2 Multicast Status

Click **Advanced Applications** and **Multicast** to display the screen as shown. This screen shows the multicast group information. See [Section 19.1 on page 127](#) for more information on multicasting.

Figure 61 Multicast Status.



Multicast Status			Multicast Setting
Index	VID	Port	Multicast Group
1	1	2	224.0.1.22

The following table describes the labels in this screen.

Table 41 Multicast Status

LABEL	DESCRIPTION
Index	This is the index number of the entry.
VID	This field displays the multicast VLAN ID.
Port	This field displays the port number that belongs to the multicast group.
Multicast Group	This field displays IP multicast group addresses.

19.3 Multicast Setting

Click **Advanced Applications**, **Multicast** and the **Multicast Setting** link to display the screen as shown. See [Section 19.1 on page 127](#) for more information on multicasting.

Figure 62 Multicast Setting

Multicast Setting		Multicast Status	IGMP Filtering Profile	MVR	
IGMP Snooping		Active <input type="checkbox"/>	Host Timeout <input type="text" value="260"/>	Leave Timeout <input type="text" value="2"/>	
IGMP Filtering		Active <input type="checkbox"/>	802.1p Priority <input type="text" value="No-Change"/>		
Unknown Multicast Frame		<input checked="" type="radio"/> Flooding <input type="radio"/> Drop			
Port	Immed. Leave	Group Limited	Max Group Num.	IGMP Filtering Profile	IGMP Querier Mode
*	<input type="checkbox"/>	<input type="checkbox"/>	<input type="text" value=""/>	Default	Auto
1	<input type="checkbox"/>	<input type="checkbox"/>	<input type="text" value="0"/>	Default	Auto
2	<input type="checkbox"/>	<input type="checkbox"/>	<input type="text" value="0"/>	Default	Auto
3	<input type="checkbox"/>	<input type="checkbox"/>	<input type="text" value="0"/>	Default	Auto
4	<input type="checkbox"/>	<input type="checkbox"/>	<input type="text" value="0"/>	Default	Auto
5	<input type="checkbox"/>	<input type="checkbox"/>	<input type="text" value="0"/>	Default	Auto
6	<input type="checkbox"/>	<input type="checkbox"/>	<input type="text" value="0"/>	Default	Auto
7	<input type="checkbox"/>	<input type="checkbox"/>	<input type="text" value="0"/>	Default	Auto
8	<input type="checkbox"/>	<input type="checkbox"/>	<input type="text" value="0"/>	Default	Auto
9	<input type="checkbox"/>	<input type="checkbox"/>	<input type="text" value="0"/>	Default	Auto

The following table describes the labels in this screen.

Table 42 Multicast Setting

LABEL	DESCRIPTION
IGMP Snooping	Use this settings to configure IGMP Snooping.
Active	Select Active to enable IGMP Snooping to forward group multicast traffic only to ports that are members of that group.
Host Timeout	Specify the time (from 1 to 16,711,450) in seconds that elapses before the switch removes an IGMP group membership entry if it does not receive report messages from the port.
Leave Timeout	Enter an IGMP leave timeout value (from 1 to 16,711,450) in seconds. This defines how many seconds the switch waits for an IGMP report before removing an IGMP snooping membership entry when an IGMP leave message is received from a host.
802.1p Priority	Select a priority level (0-7) to which the switch changes the priority in outgoing IGMP control packets. Otherwise, select No-Change to not replace the priority.
IGMP Filtering	Select Active to enable IGMP filtering to control which IGMP groups a subscriber on a port can join.
Unknown Multicast Frame	Specify the action to perform when the switch receives an unknown multicast frame. Select Drop to discard the frame(s). Select Flooding to send the frame(s) to all ports.
Port	This field displays the port number.

Table 42 Multicast Setting (continued)

LABEL	DESCRIPTION
*	<p>Settings in this row apply to all ports.</p> <p>Use this row only if you want to make some settings the same for all ports. Use this row first to set the common settings and then make adjustments on a port-by-port basis.</p> <p>Note: Changes in this row are copied to all the ports as soon as you make them.</p>
Immed. Leave	<p>Select this option to set the switch to remove this port from the multicast tree when an IGMP version 2 leave message is received on this port.</p> <p>Select this option if there is only one host connected to this port.</p>
Group Limited	Select this option to limit the number of multicast groups this port is allowed to join.
Max Group Num.	Enter the number of multicast groups this port is allowed to join. Once a port is registered in the specified number of multicast groups, any new IGMP join report frame(s) is dropped on this port.
IGMP Filtering Profile	Select the name of the IGMP filtering profile to use for this port. Otherwise, select Default to prohibit the port from joining any multicast group.
IGMP Querier Mode	<p>The switch treats an IGMP query port as being connected to an IGMP multicast router (or server). The switch forwards IGMP join or leave packets to an IGMP query port.</p> <p>Select Auto to have the switch use the port as an IGMP query port if the port receives IGMP query packets.</p> <p>Select Fixed to have the switch always use the port as an IGMP query port. Select this when you connect an IGMP multicast server to the port.</p> <p>Select Edge to stop the switch from using the port as an IGMP query port. The switch will not keep any record of an IGMP router being connected to this port. The switch does not forward IGMP join or leave packets to this port.</p>
Apply	Click Apply to save your changes to the switch's run-time memory. The switch loses these changes if it is turned off or loses power, so use the Save link on the top navigation panel to save your changes to the non-volatile memory when you are done configuring.
Cancel	Click Cancel to reset the fields.

19.4 IGMP Filtering Profile

IGMP filter profiles allow you to control access to IGMP multicast groups. This allows you to have a service available to a specific IGMP multicast group. You can configure an IGMP filter profile for an IGMP multicast group that has access to a service (like a SIP server for example). Within a profile, configure an IGMP filter to specify the multicast IP address ranges. Then assign the IGMP filter profile to the ports (in the **Multicast Setting** screen) that are allowed to use the service.

Click **Advanced Applications** and **Multicast** in the navigation panel. Click the **Multicast Setting** link and then the **IGMP Filtering Profile** link to display the screen as shown.

Figure 63 Multicast: IGMP Filtering Profile

The screenshot shows the 'IGMP Filtering Profile' configuration interface. At the top, there is a title bar with 'IGMP Filtering Profile' and a 'Multicast Setting' link. Below this is the 'Profile Setup' section, which contains three input fields: 'Profile Name', 'Start Address' (with the value '224.0.0.0'), and 'End Address' (with the value '224.0.0.0'). Underneath these fields are 'Add' and 'Clear' buttons. A table below displays a 'Default' profile with 'Start Address' and 'End Address' both set to '0.0.0.0', and checkboxes for 'Delete Profile' and 'Delete Rule'. At the bottom of the page are 'Delete' and 'Cancel' buttons.

The following table describes the labels in this screen.

Table 43 Multicast: IGMP Filtering Profile

LABEL	DESCRIPTION
Profile Name	Enter a descriptive name for the profile for identification purposes. To configure additional rule(s) for a profile that you have already added, enter the profile name and specify a different IP multicast address range.
Start Address	Type the starting multicast IP address for a range of multicast IP addresses that you want to belong to the IGMP filter profile.
End Address	Type the ending multicast IP address for a range of IP addresses that you want to belong to the IGMP filter profile. If you want to add a single multicast IP address, enter it in both the Start Address and End Address fields.
Add	Click Add to save your changes to the switch's run-time memory. The switch loses these changes if it is turned off or loses power, so use the Save link on the top navigation panel to save your changes to the non-volatile memory when you are done configuring.
Clear	Click Clear to clear the fields to the factory defaults.
Profile Name	This field displays the descriptive name of the profile.
Start Address	This field displays the start of the multicast address range.
End Address	This field displays the end of the multicast address range.
Delete	To delete the profile(s) and all the accompanying rules, select the profile(s) that you want to remove in the Delete Profile column, then click the Delete button. To delete a rule(s) from a profile, select the rule(s) that you want to remove in the Delete Rule column, then click the Delete button.
Cancel	Click Cancel to clear the Delete Profile/Delete Rule check boxes.

19.5 MVR Overview

Multicast VLAN Registration (MVR) is designed for applications (such as Media-on-Demand (MoD)) that use multicast traffic across an Ethernet ring-based service provider network.

MVR allows one single multicast VLAN to be shared among different subscriber VLANs on the network. While isolated in different subscriber VLANs, connected devices can subscribe to and unsubscribe from the multicast stream in the multicast VLAN. This improves bandwidth utilization with reduced multicast traffic in the subscriber VLANs and simplifies multicast group management.

You must enable IGMP snooping to use MVR. However, MVR only responds to IGMP join and leave control messages from multicast groups that are configured under MVR. Join and leave reports from other multicast groups are managed by IGMP snooping.

The following figure shows a network example. The subscriber VLAN (**1, 2 and 3**) information is hidden from the streaming media server, **S**. In addition, the multicast VLAN information is only visible to the switch and **S**.

Figure 64 MVR Network Example



19.5.1 Types of MVR Ports

In MVR, a source port is a port on the switch that can send and receive multicast traffic in a multicast VLAN while a receiver port can only receive multicast data. Once configured, the switch maintains a forwarding table that matches the multicast stream to the associated multicast group.

19.5.2 MVR Modes

You can set your switch to operate in either dynamic or compatible mode.

In dynamic mode, the switch sends IGMP leave and join reports to the other multicast devices (such as multicast routers or servers) in the multicast VLAN. This allows the multicast devices to update the multicast forwarding table to forward or not forward multicast traffic to the receiver ports.

In compatible mode, the switch does not send any IGMP reports. In this case, you must manually configure the forwarding settings on the multicast devices in the multicast VLAN.

19.5.3 How MVR Works

The following figure shows a multicast television example where a subscriber device (such as a computer) in VLAN 1 receives multicast traffic from the streaming media server, S, via the switch. Multiple subscriber devices can connect through a port configured as the receiver on the switch.

When the subscriber selects a television channel, computer A sends an IGMP report to the switch to join the appropriate multicast group. If the IGMP report matches one of the configured MVR multicast group addresses on the switch, an entry is created in the forwarding table on the switch. This maps the subscriber VLAN to the list of forwarding destinations for the specified multicast traffic.

When the subscriber changes the channel or turns off the computer, an IGMP leave message is sent to the switch to leave the multicast group. The switch sends a query to VLAN 1 on the receiver port (in this case, a DSL port on the switch). If there is another subscriber device connected to this port in the same subscriber VLAN, the receiving port will still be on the list of forwarding destination for the multicast traffic. Otherwise, the switch removes the receiver port from the forwarding table.

Figure 65 MVR Multicast Television Example

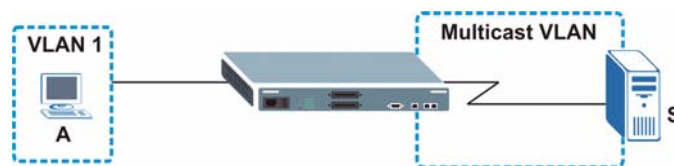

19.6 General MVR Configuration

Use the **MVR** screen to create multicast VLANs and select the receiver port(s) and a source port for each multicast VLAN. Click **Advanced Applications** and **Multicast** in the navigation panel. Click the **Multicast Setting** link and then the **MVR** link to display the screen as shown next.

Note: You can create up to three multicast VLANs and up to 256 multicast rules on the switch.

Your switch automatically creates a static VLAN (with the same VID) when you create a multicast VLAN in this screen.

Figure 66 MVR

The screenshot shows the MVR configuration page. At the top, there are tabs for 'Multicast Setting' and 'Group Configuration'. The configuration fields include:

- Active:** A checkbox that is currently unchecked.
- Name:** An empty text input field.
- Multicast VLAN ID:** An empty text input field.
- 802.1p Priority:** A dropdown menu with '0' selected.
- Mode:** Two radio buttons, 'Dynamic' (selected) and 'Compatible'.

 Below these fields is a table with the following structure:

Port	Source Port	Receiver Port	None	Tagging
*		None		<input type="checkbox"/>
1	<input type="radio"/>	<input type="radio"/>	<input checked="" type="radio"/>	<input type="checkbox"/>
2	<input type="radio"/>	<input type="radio"/>	<input checked="" type="radio"/>	<input type="checkbox"/>
3	<input type="radio"/>	<input type="radio"/>	<input checked="" type="radio"/>	<input type="checkbox"/>
4	<input type="radio"/>	<input type="radio"/>	<input checked="" type="radio"/>	<input type="checkbox"/>
5	<input type="radio"/>	<input type="radio"/>	<input checked="" type="radio"/>	<input type="checkbox"/>
6	<input type="radio"/>	<input type="radio"/>	<input checked="" type="radio"/>	<input type="checkbox"/>
7	<input type="radio"/>	<input type="radio"/>	<input checked="" type="radio"/>	<input type="checkbox"/>
8	<input type="radio"/>	<input type="radio"/>	<input checked="" type="radio"/>	<input type="checkbox"/>
9	<input type="radio"/>	<input type="radio"/>	<input checked="" type="radio"/>	<input type="checkbox"/>

 Below the table are 'Add' and 'Cancel' buttons. At the bottom of the page, there is a summary table:

VLAN	Active	Name	Mode	Source Port	Receiver Port	802.1p	Delete

 Below this summary table are 'Delete' and 'Cancel' buttons.

The following table describes the related labels in this screen.

Table 44 MVR

LABEL	DESCRIPTION
Active	Select this check box to enable MVR to allow one single multicast VLAN to be shared among different subscriber VLANs on the network.
Name	Enter a descriptive name (up to 32 printable ASCII characters) for identification purposes.
Multicast VLAN ID	Enter the VLAN ID (1 to 4094) of the multicast VLAN.
802.1p Priority	Select a priority level (0-7) with which the switch replaces the priority in outgoing IGMP control packets (belonging to this multicast VLAN).
Mode	Specify the MVR mode on the switch. Choices are Dynamic and Compatible . Select Dynamic to send IGMP reports to all MVR source ports in the multicast VLAN. Select Compatible to set the switch not to send IGMP reports.
Port	This field displays the port number on the switch.

Table 44 MVR (continued)

LABEL	DESCRIPTION
*	Settings in this row apply to all ports. Use this row only if you want to make some settings the same for all ports. Use this row first to set the common settings and then make adjustments on a port-by-port basis. Note: Changes in this row are copied to all the ports as soon as you make them.
Source Port	Select this option to set this port as the MVR source port that sends and receives multicast traffic. All source ports must belong to a single multicast VLAN.
Receiver Port	Select this option to set this port as a receiver port that only receives multicast traffic.
None	Select this option to set the port not to participate in MVR. No MVR multicast traffic is sent or received on this port.
Tagging	Select this checkbox if you want the port to tag the VLAN ID in all outgoing frames transmitted.
Add	Click Add to save your changes to the switch's run-time memory. The switch loses these changes if it is turned off or loses power, so use the Save link on the top navigation panel to save your changes to the non-volatile memory when you are done configuring.
Cancel	Click Cancel to reset the fields.
VLAN	This field displays the multicast VLAN ID.
Active	This field displays whether the multicast group is enabled or not.
Name	This field displays the descriptive name for this setting.
Mode	This field displays the MVR mode.
Source Port	This field displays the source port number(s).
Receiver Port	This field displays the receiver port number(s).
802.1p	This field displays the IEEE 802.1p priority level assigned to this VLAN.
Delete	To delete a multicast VLAN(s), select the rule(s) that you want to remove in the Delete column, then click the Delete button.
Cancel	Click Cancel to clear the Delete check boxes.

19.7 MVR Group Configuration

All source ports and receiver ports belonging to a multicast group can receive multicast data sent to this multicast group.

Configure MVR IP multicast group address(es) in the **Group Configuration** screen. Click **Group Configuration** in the **MVR** screen.

Note: A port can belong to more than one multicast VLAN. However, IP multicast group addresses in different multicast VLANs cannot overlap.

Figure 67 MVR: Group Configuration

The following table describes the labels in this screen.

Table 45 MVR: Group Configuration

LABEL	DESCRIPTION
Multicast VLAN ID	Select a multicast VLAN ID (that you configured in the MVR screen) from the drop-down list box.
Name	Enter a descriptive name for identification purposes.
Start Address	Enter the starting IP multicast address of the multicast group in dotted decimal notation. Refer to Section 19.1.1 on page 127 for more information on IP multicast addresses.
End Address	Enter the ending IP multicast address of the multicast group in dotted decimal notation. Enter the same IP address as the Start Address field if you want to configure only one IP address for a multicast group. Refer to Section 19.1.1 on page 127 for more information on IP multicast addresses.
Add	Click Add to save your changes to the switch's run-time memory. The switch loses these changes if it is turned off or loses power, so use the Save link on the top navigation panel to save your changes to the non-volatile memory when you are done configuring.
Cancel	Click Cancel to reset the fields.
MVLAN	This field displays the multicast VLAN ID.
Name	This field displays the descriptive name for this setting.
Start Address	This field displays the starting IP address of the multicast group.
End Address	This field displays the ending IP address of the multicast group.
Delete ALL	Select Delete All and click Delete to remove all entries from the table.
Delete	Select Delete Group and click Delete to remove the selected entry(ies) from the table.
Cancel	Select Cancel to clear the checkbox(es) in the table.

19.7.1 MVR Configuration Example

The following figure shows a network example where ports 1, 2 and 3 on the switch belong to VLAN 1. In addition, port 7 belongs to the multicast group with VID 200 to receive multicast traffic (the **News** and **Movie** channels) from the remote streaming media server, **S**. Computers **A**, **B** and **C** in VLAN 1 are able to receive the traffic.

Figure 68 MVR Configuration Example

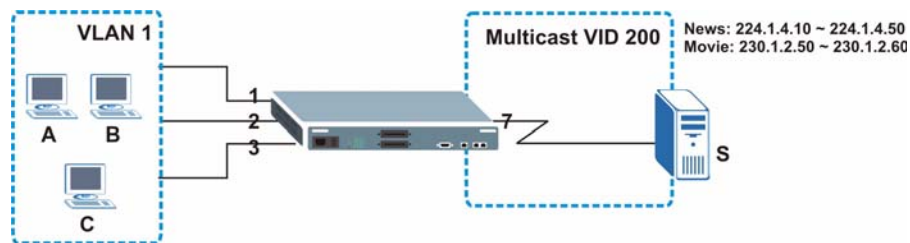

To configure the MVR settings on the switch, create a multicast group in the **MVR** screen and set the receiver and source ports.

Figure 69 MVR Configuration Example

The screenshot shows the MVR configuration interface. The 'Multicast Setting' tab is active. The 'Active' checkbox is checked. The 'Name' field is set to 'Premium', 'Multicast VLAN ID' is '200', and '802.1p Priority' is '0'. The 'Mode' is set to 'Dynamic'. Below this, a table shows port configurations. Red circles highlight the 'Receiver Port' dropdown for port 1 (set to 'None') and port 7 (set to 'None').

Port	Source Port	Receiver Port	None	Tagging
*		None		<input type="checkbox"/>
1	<input type="radio"/>	<input checked="" type="radio"/>	<input type="radio"/>	<input type="checkbox"/>
2	<input type="radio"/>	<input checked="" type="radio"/>	<input type="radio"/>	<input type="checkbox"/>
3	<input type="radio"/>	<input checked="" type="radio"/>	<input type="radio"/>	<input type="checkbox"/>
4	<input type="radio"/>	<input type="radio"/>	<input checked="" type="radio"/>	<input type="checkbox"/>
5	<input type="radio"/>	<input type="radio"/>	<input checked="" type="radio"/>	<input type="checkbox"/>
6	<input type="radio"/>	<input type="radio"/>	<input checked="" type="radio"/>	<input type="checkbox"/>
7	<input checked="" type="radio"/>	<input type="radio"/>	<input type="radio"/>	<input type="checkbox"/>
8	<input type="radio"/>	<input type="radio"/>	<input checked="" type="radio"/>	<input type="checkbox"/>
9	<input type="radio"/>	<input type="radio"/>	<input checked="" type="radio"/>	<input type="checkbox"/>

At the bottom, there are 'Add' and 'Cancel' buttons. Below the table, there is a summary table with columns: VLAN, Active, Name, Mode, Source Port, Receiver Port, 802.1p, and Delete. At the very bottom, there are 'Delete' and 'Cancel' buttons.

To set the switch to forward the multicast group traffic to the subscribers, configure multicast group settings in the **Group Configuration** screen. The following figure shows an example where two multicast groups (**News** and **Movie**) are configured for the multicast VLAN 200.

Figure 70 MVR Group Configuration Example

Group Configuration MVR

Multicast VLAN ID: 200

Name	Start Address	End Address
News	224.1.4.10	224.1.4.50

Add Cancel

MVLAN	Name	Start Address	End Address	Delete All	Delete Group
200	Movie	230.1.2.50	230.1.2.60	<input type="checkbox"/>	<input type="checkbox"/>

Delete Cancel

Figure 71 MVR Group Configuration Example

Group Configuration MVR

Multicast VLAN ID: 200

Name	Start Address	End Address
	0.0.0.0	0.0.0.0

Add Cancel

MVLAN	Name	Start Address	End Address	Delete All	Delete Group
200	Movie	230.1.2.50	230.1.2.60	<input type="checkbox"/>	<input type="checkbox"/>
	News	224.1.4.10	224.1.4.50	<input type="checkbox"/>	<input type="checkbox"/>

Delete Cancel

CHAPTER 20

Static Route

This chapter shows you how to configure static routes.

20.1 Configuring Static Routing

Static routes tell the switch how to forward IP traffic when you configure the TCP/IP parameters manually.

Click **IP Application**, **Static Routing** in the navigation panel to display the screen as shown.

Figure 72 Static Routing

Index	Active	Name	Destination Address	Subnet Mask	Gateway Address	Metric	Delete
1	Yes	Example	172.21.1.1	255.255.0.0	192.168.1.2	2	<input type="checkbox"/>

The following table describes the labels in this screen.

Table 46 Static Routing

LABEL	DESCRIPTION
Active	This field allows you to activate/deactivate this static route.
Name	Enter a descriptive name (up to 10 printable characters) for identification purposes.
Destination IP Address	This parameter specifies the IP network address of the final destination. Routing is always based on network number. If you need to specify a route to a single host, use a subnet mask of 255.255.255.255 in the subnet mask field to force the network number to be identical to the host ID.
IP Subnet Mask	Enter the subnet mask for this destination.
Gateway IP Address	Enter the IP address of the gateway. The gateway is an immediate neighbor of your switch that will forward the packet to the destination. The gateway must be a router on the same segment as your switch.

Table 46 Static Routing (continued)

LABEL	DESCRIPTION
Metric	The metric represents the “cost” of transmission for routing purposes. IP routing uses hop count as the measurement of cost, with a minimum of 1 for directly connected networks. Enter a number that approximates the cost for this link. The number need not be precise, but it must be between 1 and 15. In practice, 2 or 3 is usually a good number.
Add	Click Add to insert a new static route. Clicking Add saves your changes to the switch’s run-time memory. The switch loses these changes if it is turned off or loses power, so use the Save link on the top navigation panel to save your changes to the non-volatile memory when you are done configuring.
Cancel	Click Cancel to reset the above fields to your previous configuration.
Clear	Click Clear to set the above fields back to the factory defaults.
Index	This field displays the index number of the route. Click a number to edit the static route entry.
Active	This field displays Yes when the static route is activated and NO when it is deactivated.
Name	This field displays the descriptive name for this route. This is for identification purpose only.
Destination Address	This field displays the IP network address of the final destination.
Subnet Mask	This field displays the subnet mask for this destination.
Gateway Address	This field displays the IP address of the gateway. The gateway is an immediate neighbor of your switch that will forward the packet to the destination.
Metric	This field displays the cost of transmission for routing purposes.
Delete	Click Delete to remove the selected entry from the summary table.
Cancel	Click Cancel to clear the Delete check boxes.

CHAPTER 21

Differentiated Services

This chapter shows you how to configure Differentiated Services (DiffServ) on the switch.

21.1 DiffServ Overview

Quality of Service (QoS) is used to prioritize source-to-destination traffic flows. All packets in the flow are given the same priority. You can use CoS (class of service) to give different priorities to different packet types.

DiffServ is a class of service (CoS) model that marks packets so that they receive specific per-hop treatment at DiffServ-compliant network devices along the route based on the application types and traffic flow. Packets are marked with DiffServ Code Points (DSCPs) indicating the level of service desired. This allows the intermediary DiffServ-compliant network devices to handle the packets differently depending on the code points without the need to negotiate paths or remember state information for every flow. In addition, applications do not have to request a particular service or give advanced notice of where the traffic is going.

21.1.1 DSCP and Per-Hop Behavior

DiffServ defines a new DS (Differentiated Services) field to replace the Type of Service (ToS) field in the IP header. The DS field contains a 2-bit unused field and a 6-bit DSCP field which can define up to 64 service levels. The following figure illustrates the DS field.

DSCP is backward compatible with the three precedence bits in the ToS octet so that non-DiffServ compliant, ToS-enabled network device will not conflict with the DSCP mapping.

Figure 73 DiffServ: Differentiated Service Field

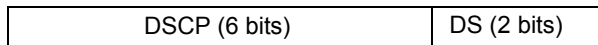

The DSCP value determines the forwarding behavior, the PHB (Per-Hop Behavior), that each packet gets across the DiffServ network. Based on the marking rule different kinds of traffic can be marked for different priorities of forwarding. Resources can then be allocated according to the DSCP values and the configured policies.

21.1.2 DiffServ Network Example

The following figure depicts a simple DiffServ network consisting of a group of contiguous DiffServ-compliant network devices.

Figure 74 DiffServ Network Example

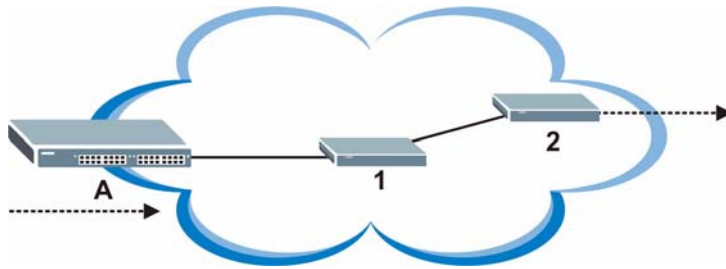

Switch **A** marks traffic flowing into the network based on the configured marking rules. Intermediary network devices **1** and **2** allocate network resources (such as bandwidth) by mapping the DSCP values and the associated policies.

21.2 Activating DiffServ

Activate DiffServ to allow the switch to enable DiffServ on the selected port(s).

Click **IP Application**, **DiffServ** in the navigation panel to display the screen as shown.

Figure 75 DiffServ

Port	Active
*	<input type="checkbox"/>
1	<input type="checkbox"/>
2	<input type="checkbox"/>
3	<input type="checkbox"/>
4	<input type="checkbox"/>
5	<input type="checkbox"/>
6	<input type="checkbox"/>
7	<input type="checkbox"/>
8	<input type="checkbox"/>
9	<input type="checkbox"/>

The following table describes the labels in this screen.

Table 47 DiffServ

LABEL	DESCRIPTION
Active	Select this option to enable DiffServ on the switch.
Port	This field displays the index number of a port on the switch.

Table 47 DiffServ (continued)

LABEL	DESCRIPTION
*	Settings in this row apply to all ports. Use this row only if you want to make some settings the same for all ports. Use this row first to set the common settings and then make adjustments on a port-by-port basis. Note: Changes in this row are copied to all the ports as soon as you make them.
Active	Select this option to enable DiffServ on the port.
Apply	Click Apply to save your changes to the switch's run-time memory. The switch loses these changes if it is turned off or loses power, so use the Save link on the top navigation panel to save your changes to the non-volatile memory when you are done configuring.
Cancel	Click Cancel to start configuring this screen again.

21.3 DSCP-to-IEEE802.1p Priority Mapping Settings

You can configure the DSCP to IEEE802.1p mapping to allow the switch to prioritize all traffic based on the incoming DSCP value according to the DiffServ to IEEE802.1p mapping table.

The following table shows the default DSCP-to-IEEE802.1P mapping.

Table 48 Default DSCP-IEEE802.1p Mapping

DSCP VALUE	0 – 7	8 – 15	16 – 23	24 – 31	32 – 39	40 – 47	48 – 55	56 – 63
IEEE802.1P	0	1	2	3	4	5	6	7

21.3.1 Configuring DSCP Settings

Use this screen to change the DSCP-IEEE 802.1p mapping click the **DSCP Setting** link in the **DiffServ** screen to display the screen as shown next.

Figure 76 DiffServ: DSCP Setting

The following table describes the labels in this screen.

Table 49 DiffServ: DSCP Setting

LABEL	DESCRIPTION
0 ... 63	This is the DSCP classification identification number. To set the IEEE802.1p priority mapping, select the priority level from the drop-down list box.
Apply	Click Apply to save your changes to the switch's run-time memory. The switch loses these changes if it is turned off or loses power, so use the Save link on the top navigation panel to save your changes to the non-volatile memory when you are done configuring.
Cancel	Click Cancel to discard all changes and start configuring the screen again.

CHAPTER 22

Maintenance

This chapter explains how to configure the maintenance screens that let you maintain the firmware and configuration files.

22.1 The Maintenance Screen

Click **Management, Maintenance** in the navigation panel to open the following screen.

Figure 77 Maintenance



The following table describes the labels in this screen.

Table 50 Maintenance

LABEL	DESCRIPTION
Current	This field displays the configuration file (Configuration 1) the switch is currently using.
Firmware Upgrade	Access this screen to upload new firmware.
Restore Configuration	Access this screen to upload a previously saved configuration file to the switch.
Backup Configuration	Access this screen to back up the current switch configuration.
Load Factory Default	Click the button to clear all switch configuration information you configured and return to the factory defaults. Note: All custom configuration will be lost. If you want to access the switch web configurator again, you may need to change the IP address of your computer to be in the same subnet as that of the default switch IP address (192.168.1.1).

Table 50 Maintenance

LABEL	DESCRIPTION
Save Configuration	Click Config 1 to save the switch's current configuration to non-volatile memory.
Reboot System	Click Config 1 to restart the switch without physically turning the power off. Note: Make sure to click the Save button in any screen to save your settings to the current configuration on the switch.

22.2 Load Factory Default

Follow the steps below to reset the switch back to the factory defaults.

- 1 In the **Maintenance** screen, click the **Click Here** button next to **Load Factory Default** to clear all switch configuration information you configured and return to the factory defaults. The following message appears.

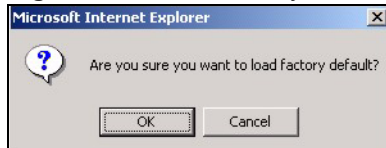
Figure 78 Load Factory Default: Confirmation

- 2 Click **OK** to begin resetting all switch configurations to the factory defaults and then wait for the switch to restart.
- 3 In the web configurator, click the **Save** button to make the changes take effect. If you want to access the switch web configurator again, you may need to change the IP address of your computer to be in the same subnet as that of the default switch IP address (192.168.1.1).

22.3 Save Configuration

Save Configuration allows you to save your settings to the switch's non-volatile memory.

Note: Whenever you make configuration changes to the switch and hit **Apply** or **Add**, the switch saves the settings to its run-time memory. These settings are lost when you restart the switch.

In the **Maintenance** screen, click the **Config 1** button next to **Save Configuration** to save your settings to the switch's non-volatile memory. These settings are not lost when you restart the switch. Alternatively, you can click the **Save** button on the top right corner of the web configurator to save your settings to the switch's non-volatile memory.

22.4 Reboot System

Reboot System allows you to restart the switch without physically turning the power off. Follow the steps below to reboot the switch.

- 1 In the **Maintenance** screen, click the **Config 1** button next to **Reboot System** to restart the switch.
- 2 Click **OK** again and then wait for the switch to restart. This does not affect the switch's configuration.

22.5 Firmware Upgrade

Make sure you have downloaded (and unzipped) the correct model firmware and version to your computer before uploading to the device.

Note: Be sure to upload the correct model firmware as uploading the wrong model firmware may damage your device.

From the **Maintenance** screen, display the **Firmware Upgrade** screen as shown next.

Figure 79 Firmware Upgrade

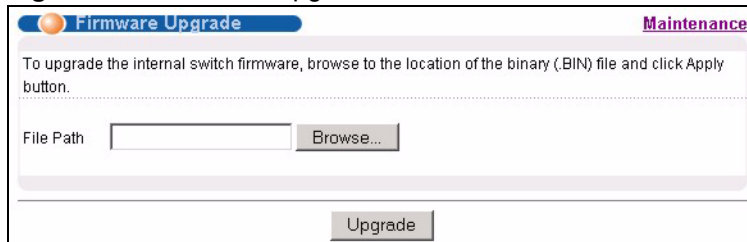

The screenshot shows a web interface for firmware upgrade. At the top, there is a blue header with a gear icon and the text "Firmware Upgrade". To the right of the header is a purple link labeled "Maintenance". Below the header, there is a light gray box containing the text: "To upgrade the internal switch firmware, browse to the location of the binary (.BIN) file and click Apply button." Below this text is a horizontal dotted line. Underneath the dotted line, there is a label "File Path" followed by a text input field and a "Browse..." button. At the bottom of the light gray box, there is an "Upgrade" button.

Type the path and file name of the firmware file you wish to upload to the switch in the **File Path** text box or click **Browse** to locate it. After you have specified the file, click **Upgrade**.

After the firmware upgrade process is complete, see the **System Info** screen to verify your current firmware version number.

22.6 Restore a Configuration File

Use this screen to restore a previously saved configuration from your computer to the switch.

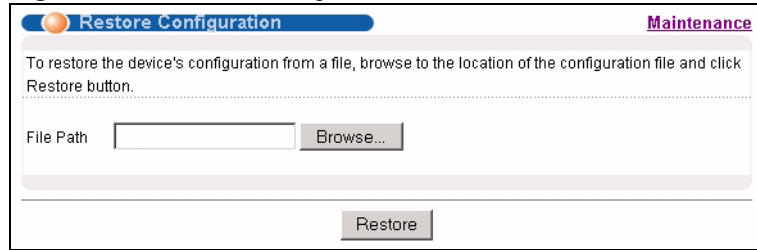
Figure 80 Restore Configuration

Restore Configuration Maintenance

To restore the device's configuration from a file, browse to the location of the configuration file and click Restore button.

File Path

Type the path and file name of the configuration file you wish to restore in the **File Path** text box or click **Browse** to display the **Choose File** screen (below) from which you can locate it. After you have specified the file, click **Restore**. "config" is the name of the configuration file on the switch, so your backup configuration file is automatically renamed when you restore using this screen.

22.7 Backup Configuration File

Backing up your switch configurations allows you to create various “snap shots” of your device from which you may restore at a later date.

Back up your current switch configuration to a computer using the **Backup Configuration** screen.

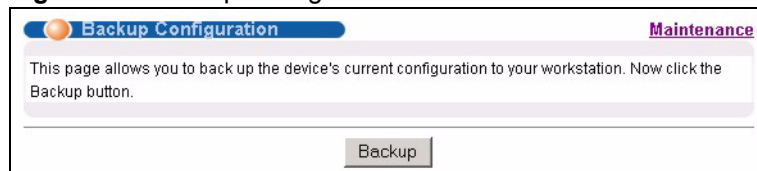
Figure 81 Backup Configuration

Backup Configuration Maintenance

This page allows you to back up the device's current configuration to your workstation. Now click the Backup button.

Follow the steps below to back up the current switch configuration to your computer in this screen.

- 1 Click **Backup**.
- 2 Click **Save** to display the **Save As** screen.
- 3 Choose a location to save the file on your computer from the **Save in** drop-down list box and type a descriptive name for it in the **File name** list box. Click **Save** to save the configuration file to your computer.

22.8 FTP Command Line

This section shows some examples of uploading to or downloading files from the switch using FTP commands. First, understand the filename conventions.

22.8.1 Filename Conventions

The configuration file contains the settings in the screens such as password, switch setup, IP Setup, etc. Once you have customized the switch's settings, they can be saved (as a plain text file) back to your computer under a filename of your choosing.

ZyNOS (ZyXEL Network Operating System sometimes referred to as the “ras” file) is the system firmware and has a “bin” filename extension.

Table 51 Filename Conventions

FILE TYPE	INTERNAL NAME	EXTERNAL NAME	DESCRIPTION
Configuration File	config		This is the configuration filename on the switch. Uploading the config file replaces the specified configuration file system, including your switch configurations, system-related data (including the default password), the error log and the trace log.
Firmware	ras	*.bin	This is the generic name for the ZyNOS firmware on the switch.

22.8.1.1 Example FTP Commands

```
ftp> put firmware.bin ras
```

This is a sample FTP session showing the transfer of the computer file "firmware.bin" to the switch.

```
ftp> get config config.cfg
```

This is a sample FTP session saving the current configuration to a file called “config.cfg” on your computer.

If your (T)FTP client does not allow you to have a destination filename different than the source, you will need to rename them as the switch only recognizes “config” and “ras”. Be sure you keep unaltered copies of both files for later use.

Note: Be sure to upload the correct model firmware as uploading the wrong model firmware may damage your device.

22.8.2 FTP Command Line Procedure

- 1 Launch the FTP client on your computer.
- 2 Enter `open`, followed by a space and the IP address of your switch.
- 3 Enter the username when prompted (for example “admin”).
- 4 Enter your password as requested (the default is “1234”).
- 5 Enter `bin` to set transfer mode to binary.

- 6 Use `put` to transfer files from the computer to the switch, for example, `put firmware.bin ras` transfers the firmware on your computer (`firmware.bin`) to the switch and renames it to “`ras`”. Similarly, `put config.cfg config` transfers the configuration file on your computer (`config.cfg`) to the switch and renames it to “`config`”. Likewise `get config config.cfg` transfers the configuration file on the switch to your computer and renames it to “`config.cfg`”. See [Table 51 on page 149](#) for more information on filename conventions.
- 7 Enter `quit` to exit the ftp prompt.

22.8.3 GUI-based FTP Clients

The following table describes some of the commands that you may see in GUI-based FTP clients.

Table 52 General Commands for GUI-based FTP Clients

COMMAND	DESCRIPTION
Host Address	Enter the address of the host server.
Login Type	Anonymous. This is when a user I.D. and password is automatically supplied to the server for anonymous access. Anonymous logins will work only if your ISP or service administrator has enabled this option. Normal. The server requires a unique User ID and Password to login.
Transfer Type	Transfer files in either ASCII (plain text format) or in binary mode. Configuration and firmware files should be transferred in binary mode.
Initial Remote Directory	Specify the default remote directory (path).
Initial Local Directory	Specify the default local directory (path).

22.8.4 FTP Restrictions

FTP will not work when:

- FTP service is disabled in the **Access Control** screen.
- The IP address(es) in the **Secured Client Set** in the **Remote Management** screen does not match the client IP address. If it does not match, the switch will disconnect the Telnet session immediately.

CHAPTER 23

Access Control

This chapter describes how to control access to the switch.

23.1 Access Control Overview

A console port and FTP are allowed one session each, Telnet and SSH share four sessions, up to five Web sessions (five different usernames and passwords) and/or limitless SNMP access control sessions are allowed.

Table 53 Access Control Overview

Console Port	SSH	Telnet	FTP	Web	SNMP
One session	Share up to four sessions		One session	Up to five accounts	No limit

A console port access control session and Telnet access control session cannot coexist when multi-login is disabled. See [Section 30.11.2 on page 191](#) for more information on disabling multi-login.

23.2 The Access Control Main Screen

Click **Management, Access Control** in the navigation panel to display the main screen as shown.

Figure 82 Access Control



Use these links to configure remote management options and create user accounts on the switch.

23.3 About SNMP

Simple Network Management Protocol (SNMP) is an application layer protocol used to manage and monitor TCP/IP-based devices. SNMP is used to exchange management information between the network management system (NMS) and a network element (NE). A manager station can manage and monitor the switch through the network via SNMP version one (SNMPv1) and/or SNMP version 2c. The next figure illustrates an SNMP management operation. SNMP is only available if TCP/IP is configured.

Figure 83 SNMP Management Model

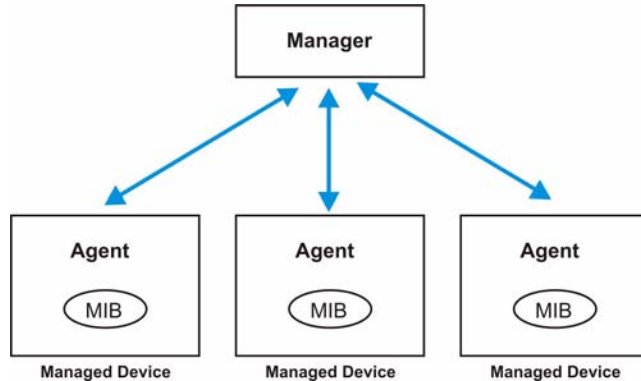

An SNMP managed network consists of two main components: agents and a manager.

An agent is a management software module that resides in a managed switch (the switch). An agent translates the local management information from the managed switch into a form compatible with SNMP. The manager is the console through which network administrators perform network management functions. It executes applications that control and monitor managed devices.

The managed devices contain object variables/managed objects that define each piece of information to be collected about a switch. Examples of variables include such as number of packets received, node port status etc. A Management Information Base (MIB) is a collection of managed objects. SNMP allows a manager and agents to communicate for the purpose of accessing these objects.

SNMP itself is a simple request/response protocol based on the manager/agent model. The manager issues a request and the agent returns responses using the following protocol operations:

Table 54 SNMP Commands

COMMAND	DESCRIPTION
Get	Allows the manager to retrieve an object variable from the agent.
Get Next	Allows the manager to retrieve the next object variable from a table or list within an agent. In SNMPv1, when a manager wants to retrieve all elements of a table from an agent, it initiates a Get operation, followed by a series of Get Next operations.

Table 54 SNMP Commands

COMMAND	DESCRIPTION
Set	Allows the manager to set values for object variables within an agent.
Trap	Used by the agent to inform the manager of some events.

23.3.1 Supported MIBs

MIBs let administrators collect statistics and monitor status and performance.

The switch supports the following MIBs:

- SNMP MIB II (RFC 1213)
- RFC 1157 SNMP v1
- RFC 1493 Bridge MIBs
- RFC 1643 Ethernet MIBs
- RFC 1155 SMI
- RFC 2674 SNMPv2, SNMPv2c
- RFC 1757 RMON
- Private MIBs

23.3.2 SNMP Traps

The switch sends traps to an SNMP manager when an event occurs. SNMP traps supported are outlined in the following table.

Table 55 SNMP Traps

OBJECT LABEL	OBJECT ID	DESCRIPTION
SNMPv2 Traps		
Cold Start	1.3.6.1.6.3.1.1.5.1	This trap is sent when the switch is turned on.
WarmStart	1.3.6.1.6.3.1.1.5.2	This trap is sent when the switch restarts.
linkDown	1.3.6.1.6.3.1.1.5.3	This trap is sent when the Ethernet link is down.
linkUp	1.3.6.1.6.3.1.1.5.4	This trap is sent when the Ethernet link is up.
authenticationFailure	1.3.6.1.6.3.1.1.5.5	This trap is sent when an SNMP request comes from non-authenticated hosts.
RFC 1493 Traps		
newRoot	1.3.6.1.2.1.17.0.1	This trap is sent when the STP topology changes.
topology change	1.3.6.1.2.1.17.0.2	This trap is sent when the STP root switch changes.

23.3.3 Configuring SNMP

From the **Access Control** screen, display the **SNMP** screen. You can click **Access Control** to go back to the **Access Control** screen.

Figure 84 Access Control: SNMP

The following table describes the labels in this screen.

Table 56 Access Control: SNMP

LABEL	DESCRIPTION
Get Community	Enter the get community, which is the password for the incoming Get- and GetNext-requests from the management station.
Set Community	Enter the set community, which is the password for incoming Set- requests from the management station.
Trap Community	Enter the trap community, which is the password sent with each trap to the SNMP manager.
Trap Destination	Enter the IP addresses of up to four stations to send your SNMP traps to.
Apply	Click Apply to save your changes to the switch's run-time memory. The switch loses these changes if it is turned off or loses power, so use the Save link on the top navigation panel to save your changes to the non-volatile memory when you are done configuring.
Cancel	Click Cancel to begin configuring this screen afresh.

23.4 Setting Up Login Accounts

Up to five people (one administrator and four non-administrators) may access the switch via web configurator at any one time.

- An administrator is someone who can both view and configure switch changes. The username for the Administrator is always **admin**. The default administrator password is **1234**.

Note: It is highly recommended that you change the default administrator password (**1234**).

- A non-administrator (username is something other than **admin**) is someone who can view but not configure switch settings.

Click **Access Control** from the navigation panel and then click **Logins** from this screen.

Figure 85 Access Control: Logins

The following table describes the labels in this screen.

Table 57 Access Control: Logins

LABEL	DESCRIPTION
Administrator	This is the default administrator account with the “admin” user name. You cannot change the default administrator user name. Only the administrator has read/write access.
Old Password	Type the existing system password (1234 is the default password when shipped).
New Password	Enter your new system password.
Retype to confirm	Retype your new system password for confirmation
Edit Logins	You may configure passwords for up to four users. These people have read-only access.
User Name	Set a user name (up to 30 characters long).
Password	Enter your new system password.
Retype to confirm	Retype your new system password for confirmation
Apply	Click Apply to save your changes to the switch’s run-time memory. The switch loses these changes if it is turned off or loses power, so use the Save link on the top navigation panel to save your changes to the non-volatile memory when you are done configuring.
Cancel	Click Cancel to begin configuring this screen afresh.

23.5 SSH Overview

Unlike Telnet or FTP, which transmit data in clear text, SSH (Secure Shell) is a secure communication protocol that combines authentication and data encryption to provide secure encrypted communication between two hosts over an unsecured network.

Figure 86 SSH Communication Example

23.6 How SSH works

The following table summarizes how a secure connection is established between two remote hosts.

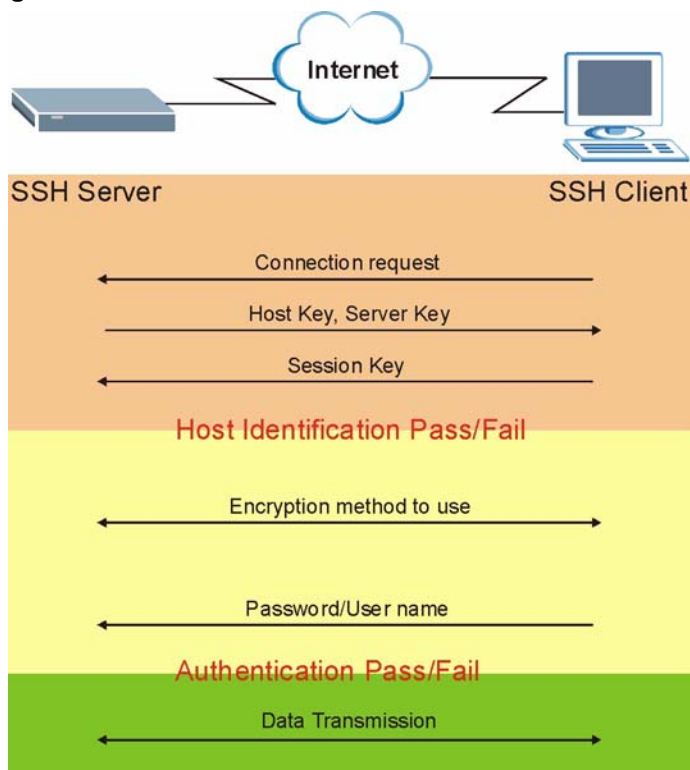
Figure 87 How SSH Works

1 Host Identification

The SSH client sends a connection request to the SSH server. The server identifies itself with a host key. The client encrypts a randomly generated session key with the host key and server key and sends the result back to the server.

The client automatically saves any new server public keys. In subsequent connections, the server public key is checked against the saved version on the client computer.

2 Encryption Method

Once the identification is verified, both the client and server must agree on the type of encryption method to use.

3 Authentication and Data Transmission

After the identification is verified and data encryption activated, a secure tunnel is established between the client and the server. The client then sends its authentication information (user name and password) to the server to log in to the server.

23.7 SSH Implementation on the Switch

Your switch supports SSH version 2 using RSA authentication and three encryption methods (DES, 3DES and Blowfish). The SSH server is implemented on the switch for remote management and file transfer on port 22. Only one SSH connection is allowed at a time.

23.7.1 Requirements for Using SSH

You must install an SSH client program on a client computer (Windows or Linux operating system) that is used to connect to the switch over SSH.

23.7.2 SSH Login Example

You can use an SSH client program to access the switch. The following figure shows an example using a text-based SSH client program. Refer to the documentation that comes with your SSH program for information on using it.

Figure 88 SSH Login Example

```
C:\>ssh2 admin@192.168.1.1
@@@@@@@@@@@@@@@@@@@@@@@@@@@@@@@@@@@@@@@@@@@@@@@@@@@@@@@@@@@@@@@@@@@@@@@@@@@@@@@@@@@@
@           WARNING: HOST IDENTIFICATION HAS CHANGED!           @
@@@@@@@@@@@@@@@@@@@@@@@@@@@@@@@@@@@@@@@@@@@@@@@@@@@@@@@@@@@@@@@@@@@@@@@@@@@@@@@@@@@@
IT IS POSSIBLE THAT SOMEONE IS DOING SOMETHING NASTY!
Someone could be eavesdropping on you right now (man-in-the-middle attack)!
It is also possible that the host key has just been changed.
Please contact your system administrator.
Add correct host key to "C:/Documents and Settings/Administrator/Application
Data/SSH/hostkeys/key_22_192.168.1.1.pub" to get rid of this message.
Received server key's fingerprint: xigil-gidot-homug-duzab-tocyh-pamyb-
ronep-tisaf-hebip-gokeb-goxix You can get a public key's fingerprint by
running % ssh-keygen -F publickey.pub
on the keyfile. Agent forwarding is disabled to avoid attacks by corrupted
servers. X11 forwarding is disabled to avoid attacks by corrupted servers.
Are you sure you want to continue connecting (yes/no)? yes

Do you want to change the host key on disk (yes/no)? yes

Agent forwarding re-enabled.
X11 forwarding re-enabled.
Host key saved to C:/Documents and Settings/Administrator/Application Data/
SSH/hostkeys/key_22_192.168.1.1.pub host key for 192.168.1.1, accepted by
Administrator Thu May 12 2005 09:52:21
admin's password:
Authentication successful.
Copyright (c) 1994 - 2006 ZyXEL Communications Corp.
ras>
```

23.8 Introduction to HTTPS

HTTPS (Hyper Text Transfer Protocol over Secure Socket Layer, or HTTP over SSL) is a web protocol that encrypts and decrypts web pages. Secure Socket Layer (SSL) is an application-level protocol that enables secure transactions of data by ensuring confidentiality (an unauthorized party cannot read the transferred data), authentication (one party can identify the other party) and data integrity (you know if data has been changed).

It relies upon certificates, public keys, and private keys.

HTTPS on the switch is used so that you may securely access the switch using the web configurator. The SSL protocol specifies that the SSL server (the switch) must always authenticate itself to the SSL client (the computer which requests the HTTPS connection with the switch), whereas the SSL client only should authenticate itself when the SSL server requires it to do so. Authenticating client certificates is optional and if selected means the SSL-client must send the switch a certificate. You must apply for a certificate for the browser from a CA that is a trusted CA on the switch.

Please refer to the following figure.

- 1 HTTPS connection requests from an SSL-aware web browser go to port 443 (by default) on the switch's WS (web server).
- 2 HTTP connection requests from a web browser go to port 80 (by default) on the switch's WS (web server).

Figure 89 HTTPS Implementation

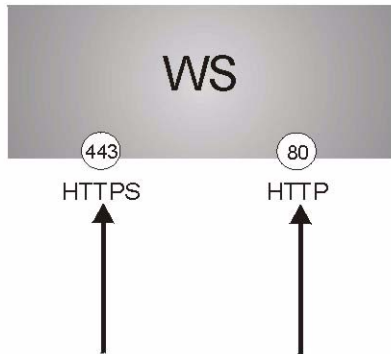

Note: If you disable **HTTP** in the **Service Access Control** screen, then the switch blocks all HTTP connection attempts.

23.9 HTTPS Example

If you haven't changed the default HTTPS port on the switch, then in your browser enter "https://switch IP Address/" as the web site address where "switch IP Address" is the IP address or domain name of the switch you wish to access.

23.9.1 Internet Explorer Warning Messages

When you attempt to access the switch HTTPS server, a Windows dialog box pops up asking if you trust the server certificate. Click **View Certificate** if you want to verify that the certificate is from the switch.

You see the following **Security Alert** screen in Internet Explorer. Select **Yes** to proceed to the web configurator login screen; if you select **No**, then web configurator access is blocked.

Figure 90 Security Alert Dialog Box (Internet Explorer)

23.9.2 Netscape Navigator Warning Messages

When you attempt to access the switch HTTPS server, a **Website Certified by an Unknown Authority** screen pops up asking if you trust the server certificate. Click **Examine Certificate** if you want to verify that the certificate is from the switch.

If **Accept this certificate temporarily for this session** is selected, then click **OK** to continue in Netscape.

Select **Accept this certificate permanently** to import the switch's certificate into the SSL client.

Figure 91 Security Certificate 1 (Netscape)

Figure 92 Security Certificate 2 (Netscape)

23.9.3 The Main Screen

After you accept the certificate and enter the login username and password, the switch main screen appears. The lock displayed in the bottom right of the browser status bar denotes a secure connection.

Figure 93 Example: Lock Denoting a Secure Connection

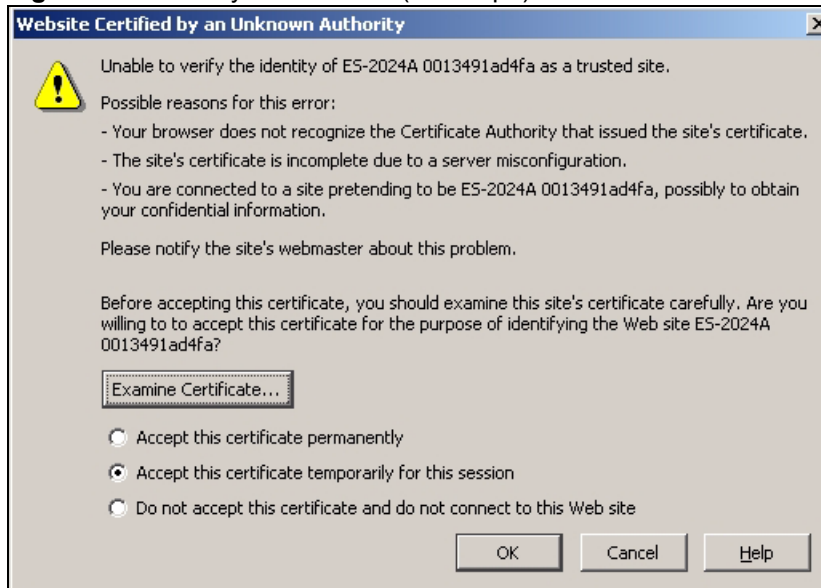
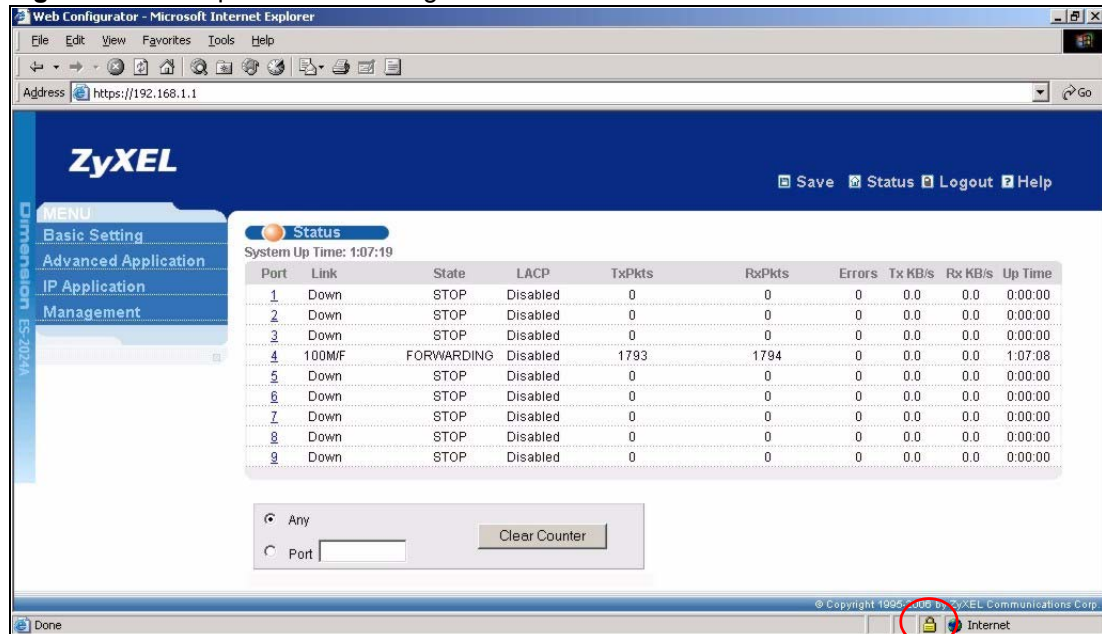
23.10 Service Port Access Control

Service Access Control allows you to decide what services you may use to access the switch. You may also change the default service port and configure “trusted computer(s)” for each service in the **Remote Management** screen (discussed later). Click **Access Control** to go back to the main **Access Control** screen.

Figure 94 Access Control: Service Access Control

Services	Active	Service Port	Timeout
Telnet	<input checked="" type="checkbox"/>	23	
SSH	<input checked="" type="checkbox"/>	22	
FTP	<input checked="" type="checkbox"/>	21	
HTTP	<input checked="" type="checkbox"/>	80	3 Minutes
HTTPS	<input checked="" type="checkbox"/>	443	
ICMP	<input checked="" type="checkbox"/>		
SNMP	<input checked="" type="checkbox"/>		

The following table describes the fields in this screen.

Table 58 Access Control: Service Access Control

LABEL	DESCRIPTION
Services	Services you may use to access the switch are listed here.
Active	Select this option for the corresponding services that you want to allow to access the switch.
Service Port	For Telnet, SSH, FTP, HTTP or HTTPS services, you may change the default service port by typing the new port number in the Server Port field. If you change the default port number then you will have to let people (who wish to use the service) know the new port number for that service.
Timeout	Type how many minutes a management session (via the web configurator) can be left idle before the session times out. After it times out you have to log in with your password again. Very long idle time-outs may have security risks.
Apply	Click Apply to save your changes to the switch's run-time memory. The switch loses these changes if it is turned off or loses power, so use the Save link on the top navigation panel to save your changes to the non-volatile memory when you are done configuring.
Cancel	Click Cancel to begin configuring this screen afresh.

23.11 Remote Management

From the **Access Control** screen, display the **Remote Management** screen as shown next.

You can specify a group of one or more “trusted computers” from which an administrator may use a service to manage the switch. Click **Access Control** to return to the **Access Control** screen.

Figure 95 Access Control: Remote Management

Entry	Active	Start Address	End Address	Telnet	FTP	HTTP	ICMP	SNMP	SSH	HTTPS
1	<input checked="" type="checkbox"/>	0.0.0.0	0.0.0.0	<input checked="" type="checkbox"/>	<input checked="" type="checkbox"/>	<input checked="" type="checkbox"/>	<input checked="" type="checkbox"/>	<input checked="" type="checkbox"/>	<input checked="" type="checkbox"/>	<input checked="" type="checkbox"/>
2	<input type="checkbox"/>	0.0.0.0	0.0.0.0	<input type="checkbox"/>	<input type="checkbox"/>	<input type="checkbox"/>	<input type="checkbox"/>	<input type="checkbox"/>	<input type="checkbox"/>	<input type="checkbox"/>
3	<input type="checkbox"/>	0.0.0.0	0.0.0.0	<input type="checkbox"/>	<input type="checkbox"/>	<input type="checkbox"/>	<input type="checkbox"/>	<input type="checkbox"/>	<input type="checkbox"/>	<input type="checkbox"/>
4	<input type="checkbox"/>	0.0.0.0	0.0.0.0	<input type="checkbox"/>	<input type="checkbox"/>	<input type="checkbox"/>	<input type="checkbox"/>	<input type="checkbox"/>	<input type="checkbox"/>	<input type="checkbox"/>

Apply Cancel

The following table describes the labels in this screen.

Table 59 Access Control: Remote Management

LABEL	DESCRIPTION
Entry	This is the client set index number. A “client set” is a group of one or more “trusted computers” from which an administrator may use a service to manage the switch.
Active	Select this check box to activate this secured client set. Clear the check box if you wish to temporarily disable the set without deleting it.
Start Address End Address	Configure the IP address range of trusted computers from which you can manage this switch. The switch checks if the client IP address of a computer requesting a service or protocol matches the range set here. The switch immediately disconnects the session if it does not match.
Telnet/FTP/ HTTP/ICMP/ SNMP/SSH/ HTTPS	Select services that may be used for managing the switch from the specified trusted computers.
Apply	Click Apply to save your changes to the switch’s run-time memory. The switch loses these changes if it is turned off or loses power, so use the Save link on the top navigation panel to save your changes to the non-volatile memory when you are done configuring.
Cancel	Click Cancel to begin configuring this screen afresh.

CHAPTER 24

Diagnostic

This chapter explains the **Diagnostic** screen.

24.1 Diagnostic

Click **Management, Diagnostic** in the navigation panel to open this screen. Use this screen to check system logs, ping IP addresses or perform port tests.

Figure 96 Diagnostic

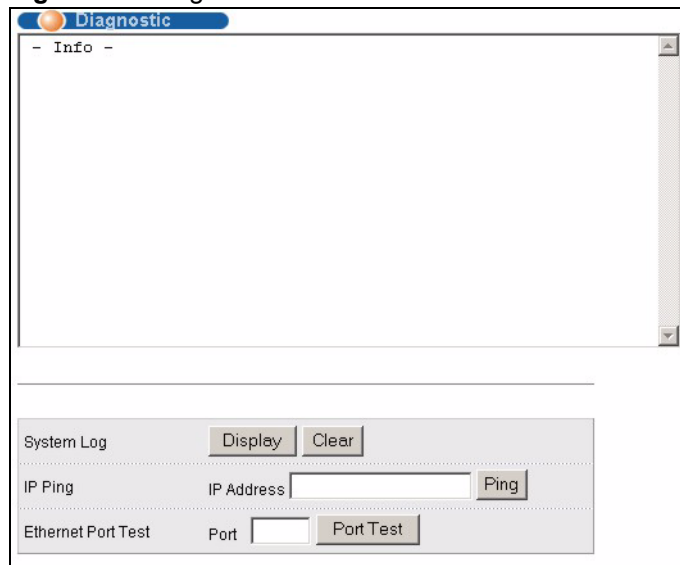

The following table describes the labels in this screen.

Table 60 Diagnostic

LABEL	DESCRIPTION
System Log	Click Display to display a log of events in the multi-line text box. Click Clear to empty the text box and reset the syslog entry.
IP Ping	Type the IP address of a device that you want to ping in order to test a connection. Click Ping to have the switch ping the IP address (in the field to the left).
Ethernet Port Test	Type a port number and click Port Test to perform internal loopback test.

CHAPTER 25

Syslog

This chapter explains the syslog screens.

25.1 Syslog Overview

The syslog protocol allows devices to send event notification messages across an IP network to syslog servers that collect the event messages. A syslog-enabled device can generate a syslog message and send it to a syslog server.

Syslog is defined in RFC 3164. The RFC defines the packet format, content and system log related information of syslog messages. Each syslog message has a facility and severity level. The syslog facility identifies a file in the syslog server. Refer to the documentation of your syslog program for details. The following table describes the syslog severity levels.

Table 61 Syslog Severity Levels

CODE	SEVERITY
0	Emergency: The system is unusable.
1	Alert: Action must be taken immediately.
2	Critical: The system condition is critical.
3	Error: There is an error condition on the system.
4	Warning: There is a warning condition on the system.
5	Notice: There is a normal but significant condition on the system.
6	Informational: The syslog contains an informational message.
7	Debug: The message is intended for debug-level purposes.

25.2 Syslog Setup

Click **Management** and then **Syslog** in the navigation panel to display this screen. The syslog feature sends logs to an external syslog server. Use this screen to configure the device's system logging settings.

Figure 97 Syslog

Logging type	Active	Facility
System	<input type="checkbox"/>	local use 0
Interface	<input type="checkbox"/>	local use 0
Switch	<input type="checkbox"/>	local use 0
Authentication	<input type="checkbox"/>	local use 0
IP	<input type="checkbox"/>	local use 0

The following table describes the labels in this screen.

Table 62 Syslog

LABEL	DESCRIPTION
Syslog	Select Active to turn on syslog (system logging) and then configure the syslog setting
Logging Type	This column displays the names of the categories of logs that the device can generate.
Active	Select this option to set the device to generate logs for the corresponding category.
Facility	The log facility allows you to send logs to different files in the syslog server. Refer to the documentation of your syslog program for more details.
Apply	Click Apply to save your changes to the switch's run-time memory. The switch loses these changes if it is turned off or loses power, so use the Save link on the top navigation panel to save your changes to the non-volatile memory when you are done configuring.
Cancel	Click Cancel to reset the fields.

25.3 Syslog Server Setup

Click **Management** and then **Syslog** in the navigation panel to display the **Syslog Setup** screen. Click the **Syslog Server Setup** link to open the following screen. Use this screen to configure a list of external syslog servers.

Figure 98 Syslog: Server Setup

The following table describes the labels in this screen.

Table 63 Syslog: Server Setup

LABEL	DESCRIPTION
Active	Select this check box to have the device send logs to this syslog server. Clear the check box if you want to create a syslog server entry but not have the device send logs to it (you can edit the entry later).
Server Address	Enter the IP address of the syslog server.
Log Level	Select the severity level(s) of the logs that you want the device to send to this syslog server. The lower the number, the more critical the logs are.
Add	Click Add to save your changes to the switch's run-time memory. The switch loses these changes if it is turned off or loses power, so use the Save link on the top navigation panel to save your changes to the non-volatile memory when you are done configuring.
Cancel	Click Cancel to reset the fields.
Clear	Click Clear to return the fields to the factory defaults.
Index	This is the index number of a syslog server entry. Click this number to edit the entry.
Active	This field displays Yes if the device is to send logs to the syslog server. No displays if the device is not to send logs to the syslog server.
IP Address	This field displays the IP address of the syslog server.
Log Level	This field displays the severity level of the logs that the device is to send to this syslog server.
Delete	Select an entry's Delete check box and click Delete to remove the entry.
Cancel	Click Cancel to reset the fields.

CHAPTER 26

Cluster Management

This chapter introduces cluster management.

26.1 Clustering Management Status Overview

Cluster Management allows you to manage switches through one switch, called the cluster manager. The switches must be directly connected and be in the same VLAN group so as to be able to communicate with one another.

Table 64 ZyXEL Clustering Management Specifications

Maximum number of cluster members	24
Cluster Member Models	Must be compatible with ZyXEL cluster management implementation.
Cluster Manager	The switch through which you manage the cluster member switches.
Cluster Members	The switches being managed by the cluster manager switch.

In the following example, switch **A** in the basement is the cluster manager and the other switches on the upper floors of the building are cluster members.

Figure 99 Clustering Application Example

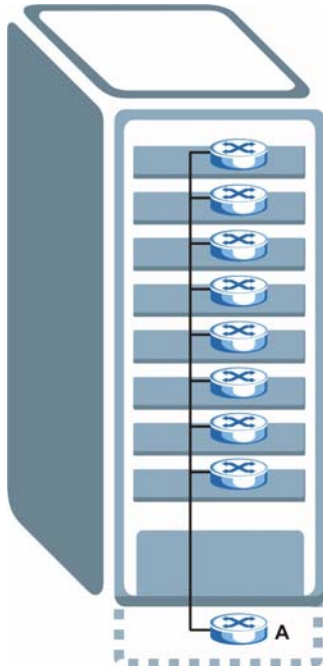

26.2 Clustering Management Status

Click **Management**, **Cluster Management** in the navigation panel to display the following screen.

Note: A cluster can only have one manager.

Figure 100 Clustering Management: Status

Clustering Management Status		Configuration		
Status	Manager			
Manager	00:a0:c5:d4:88:bf			
The Number Of Member = 2				
Index	MacAddr	Name	Model	Status
1	00:a0:c5:01:23:45	ES-4024A	ES-4024A	Online
2	00:a0:c5:5f:a2:b9	ES-3024	ES-3024	Online

The following table describes the labels in this screen.

Table 65 Clustering Management: Status

LABEL	DESCRIPTION
Status	This field displays the role of this switch within the cluster. Manager Member (you see this if you access this screen in the cluster member switch directly and not via the cluster manager) None (neither a manager nor a member of a cluster)
Manager	This field displays the cluster manager switch's hardware MAC address.
The Number of Member	This field displays the number of switches that make up this cluster. The following fields describe the cluster member switches.
Index	You can manage cluster member switches via the cluster manager switch. Each number in the Index column is a hyperlink leading to the cluster member switch's web configurator (see Figure 101 on page 173).
MacAddr	This is the cluster member switch's hardware MAC address.
Name	This is the cluster member switch's System Name .
Model	This field displays the model name.
Status	This field displays: Online (the cluster member switch is accessible) Error (for example the cluster member switch password was changed or the switch was set as the manager and so left the member list, etc.) Offline (the switch is disconnected - Offline shows approximately 1.5 minutes after the link between cluster member and manager goes down)

26.2.1 Cluster Member Switch Management

Go to the **Clustering Management Status** screen of the cluster manager switch and then select an **Index** hyperlink from the list of members to go to that cluster member switch's web configurator home page. This cluster member web configurator home page and the home page that you'd see if you accessed it directly are different.

Figure 101 Cluster Management: Cluster Member Web Configurator Screen



26.2.1.1 Uploading Firmware to a Cluster Member Switch

You can use FTP to upload firmware to a cluster member switch through the cluster manager switch as shown in the following example.

Figure 102 Example: Uploading Firmware to a Cluster Member Switch

```

C:\>ftp 192.168.1.1
Connected to 192.168.1.1.
220 FTP version 1.0 ready at Thu Jan  1 00:47:52 1970
User (192.168.1.1:(none)): admin
331 Enter PASS command
Password:
230 Logged in
ftp> ls
200 Port command okay
150 Opening data connection for LIST
--w--w--w-  1 owner   group      3209434 Jul  01 12:00 ras
-rw-rw-rw-  1 owner   group      393216  Jul  01 12:00 config
--w--w--w-  1 owner   group           0 Jul  01 12:00 fw-00-a0-c5-d4-88-bf
-rw-rw-rw-  1 owner   group           0 Jul  01 12:00 config-00-a0-c5-d4-88-bf
226 File sent OK
ftp: 463 bytes received in 0.00Seconds 463000.00Kbytes/sec.
ftp> bin
200 Type I OK
ftp> put 350du1.bin fw-00-a0-c5-d4-88-bf
200 Port command okay
150 Opening data connection for STOR fw-00-a0-c5-d4-88-bf
226 File received OK
ftp: 262144 bytes sent in 0.63Seconds 415.44Kbytes/sec.
ftp>

```

The following table explains some of the FTP parameters.

Table 66 FTP Upload to Cluster Member Example

FTP PARAMETER	DESCRIPTION
User	Enter "admin".
Password	The web configurator password default is 1234.
ls	Enter this command to list the name of cluster member switch's firmware and configuration file.
350du1.bin	This is the name of the firmware file you want to upload to the cluster member switch.
fw-00-a0-c5-d4-88-bf	This is the cluster member switch's firmware name as seen in the cluster manager switch.
config-00-a0-c5-d4-88-bf	This is the cluster member switch's configuration file name as seen in the cluster manager switch.

26.3 Clustering Management Configuration

Click **Configuration** from the **Cluster Management** screen to display the next screen. Use this screen to configure cluster management.

Figure 103 Clustering Management Configuration

The following table describes the labels in this screen.

Table 67 Clustering Management Configuration



LABEL	DESCRIPTION
Clustering Manager	
Active	Select Active to have this switch become the cluster manager switch. A cluster can only have one manager. Other (directly connected) switches that are set to be cluster managers will not be visible in the Clustering Candidates list. If a switch that was previously a cluster member is later set to become a cluster manager, then its Status is displayed as Error in the Cluster Management Status screen and a warning icon () appears in the member summary list below.
Name	Type a name to identify the Clustering Manager . You may use up to 32 printable characters (spaces are allowed).
VID	This is the VLAN ID and is only applicable if the switch is set to 802.1Q VLAN. All switches must be directly connected and in the same VLAN group to belong to the same cluster. Switches that are not in the same VLAN group are not visible in the Clustering Candidates list. This field is ignored if the Clustering Manager is using Port-based VLAN.
Apply	Click Apply to save your changes to the switch's run-time memory. The switch loses these changes if it is turned off or loses power, so use the Save link on the top navigation panel to save your changes to the non-volatile memory when you are done configuring.
Cancel	Click Cancel to begin configuring this part of the screen afresh.
Clustering Candidate	The following fields relate to the switches that are potential cluster members.

Table 67 Clustering Management Configuration (continued)

LABEL	DESCRIPTION
List	A list of suitable candidates found by auto-discovery is shown here. The switches must be directly connected. Directly connected switches that are set to be cluster managers will not be visible in the Clustering Candidate list. Switches that are not in the same management VLAN group will not be visible in the Clustering Candidate list.
Password	Each cluster member's password is its web configurator password. Select a member in the Clustering Candidate list and then enter its web configurator password. If that switch administrator changes the web configurator password afterwards, then it cannot be managed from the Cluster Manager . Its Status is displayed as Error in the Cluster Management Status screen and a warning icon () appears in the member summary list below. If multiple devices have the same password then hold [SHIFT] and click those switches to select them. Then enter their common web configurator password.
Add	Click Add to save your settings to the switch's run-time memory. The switch loses these changes if it is turned off or loses power, so use the Save link on the top navigation panel to save your changes to the non-volatile memory when you are done configuring.
Cancel	Click Cancel to begin configuring this part of the screen afresh.
Refresh	Click Refresh to perform auto-discovery again to list potential cluster members.
The next summary table shows the information for the clustering members configured.	
Index	This is the index number of a cluster member switch.
MacAddr	This is the cluster member switch's hardware MAC address.
Name	This is the cluster member switch's System Name .
Model	This is the cluster member switch's model name.
Remove	Select this checkbox and then click the Remove button to remove a cluster member switch from the cluster.
Cancel	Click Cancel to begin configuring this part of the screen afresh.

CHAPTER 27

MAC Table

This chapter introduces the **MAC Table** screen.

27.1 MAC Table Overview

The **MAC Table** screen (a MAC table is also known as a filtering database) shows how frames are forwarded or filtered across the switch's ports. It shows what device MAC address, belonging to what VLAN group (if any) is forwarded to which port(s) and whether the MAC address is dynamic (learned by the switch) or static (manually entered in the **Static MAC Forwarding** screen).

The switch uses the MAC table to determine how to forward frames. See the following figure.

- 1 The switch examines a received frame and learns the port on which this source MAC address came.
- 2 The switch checks to see if the frame's destination MAC address matches a source MAC address already learned in the MAC table.
 - If the switch has already learned the port for this MAC address, then it forwards the frame to that port.
 - If the switch has not already learned the port for this MAC address, then the frame is flooded to all ports. Too much port flooding leads to network congestion.
 - If the switch has already learned the port for this MAC address, but the destination port is the same as the port it came in on, then it filters the frame.

Figure 104 MAC Table Flowchart

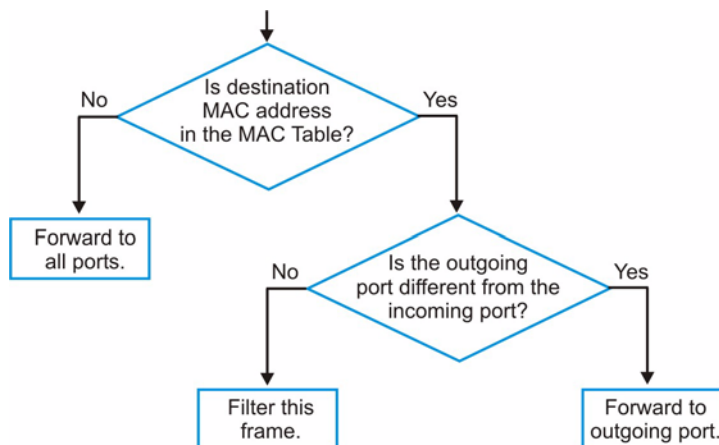

27.2 Viewing the MAC Table

Note: Click MAC, VID or Port in the Sort by field to display the MAC address entries.

Click **Management, MAC Table** in the navigation panel to display the following screen.

Figure 105 MAC Table

Index	MAC Address	VID	Port	Type
1	00:85:a0:01:01:00	1	8	dynamic
2	00:85:a0:01:01:04	1	8	dynamic
3	00:a0:c5:00:00:01	1	2	dynamic
4	00:a0:c5:fe:ea:71	1	CPU	static
5	00:a0:c5:fe:ea:71	2	CPU	static

The following table describes the labels in this screen.

Table 68 MAC Table

LABEL	DESCRIPTION
Sort by	Click one of the following buttons to display and arrange the data according to that button type. The information is then displayed in the summary table below.
MAC	Click this button to display and arrange the data according to MAC address.
VID	Click this button to display and arrange the data according to VLAN group.
Port	Click this button to display and arrange the data according to port number. This field displays Drop if you configure a filtering rule to drop the traffic from the MAC address.
Index	This is the incoming frame index number.
MAC Address	This is the MAC address of the device from which this incoming frame came.
VID	This is the VLAN group to which this frame belongs.
Port	This is the port from which the above MAC address was learned. This field displays drop if you configure a filter rule for the MAC address in the Filtering screen.
Type	This shows whether the MAC address is dynamic (learned by the switch) or static (manually entered in the Static MAC Forwarding screen).

CHAPTER 28

ARP Table

This chapter introduces ARP Table.

28.1 ARP Table Overview

Address Resolution Protocol (ARP) is a protocol for mapping an Internet Protocol address (IP address) to a physical machine address, also known as a Media Access Control or MAC address, on the local area network.

An IP (version 4) address is 32 bits long. In an Ethernet LAN, MAC addresses are 48 bits long. The ARP Table maintains an association between each MAC address and its corresponding IP address.

28.1.1 How ARP Works

When an incoming packet destined for a host device on a local area network arrives at the switch, the switch's ARP program looks in the ARP Table and, if it finds the address, sends it to the device.

If no entry is found for the IP address, ARP broadcasts the request to all the devices on the LAN. The switch fills in its own MAC and IP address in the sender address fields, and puts the known IP address of the target in the target IP address field. In addition, the switch puts all ones in the target MAC field (FF.FF.FF.FF.FF.FF is the Ethernet broadcast address). The replying device (which is either the IP address of the device being sought or the router that knows the way) replaces the broadcast address with the target's MAC address, swaps the sender and target pairs, and unicasts the answer directly back to the requesting machine. ARP updates the ARP Table for future reference and then sends the packet to the MAC address that replied.

28.2 Viewing the ARP Table

Click **Management, ARP Table** in the navigation panel to open the following screen. Use the ARP table to view IP-to-MAC address mapping(s).

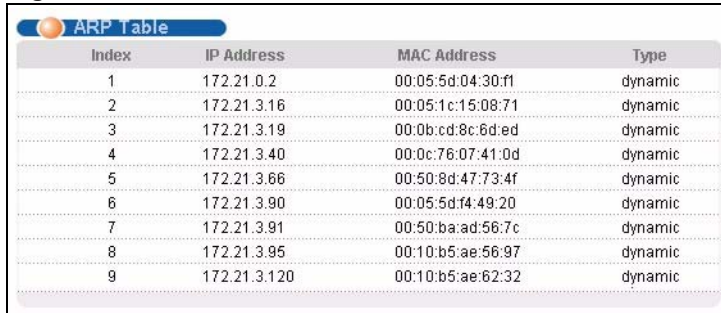
Figure 106 ARP Table

Index	IP Address	MAC Address	Type
1	172.21.0.2	00:05:5d:04:30:f1	dynamic
2	172.21.3.16	00:05:1c:15:08:71	dynamic
3	172.21.3.19	00:0b:cd:8c:6d:ed	dynamic
4	172.21.3.40	00:0c:76:07:41:0d	dynamic
5	172.21.3.66	00:50:8d:47:73:4f	dynamic
6	172.21.3.90	00:05:5d:f4:49:20	dynamic
7	172.21.3.91	00:50:ba:ad:56:7c	dynamic
8	172.21.3.95	00:10:b5:ae:56:97	dynamic
9	172.21.3.120	00:10:b5:ae:62:32	dynamic

The following table describes the labels in this screen.

Table 69 ARP Table

LABEL	DESCRIPTION
Index	This is the ARP Table entry number.
IP Address	This is the learned IP address of a device connected to a switch port with corresponding MAC address below.
MAC Address	This is the MAC address of the device with corresponding IP address above.
Type	This shows whether the MAC address is dynamic (learned by the switch) or static (manually entered in the Static MAC Forwarding screen).

Configure Clone

This chapter shows you how you can copy the settings of one port onto other ports.

29.1 Configure Clone Settings

Cloning allows you to copy the basic and advanced settings from a source port to a destination port or ports. Click **Management, Configure Clone** to open the following screen.

Figure 107 Configure Clone

The screenshot shows the 'Configure Clone' web interface. At the top, there is a title bar with the text 'Configure Clone' and a small logo. Below the title bar, there are two input fields: 'Source Port' and 'Destination'. Underneath these fields is a section titled 'Port Features'. This section is divided into two sub-sections: 'Basic Setting' and 'Advanced Application'. Each sub-section contains a list of checkboxes for various port settings. At the bottom of the interface are 'Apply' and 'Cancel' buttons.

Section	Settings
Basic Setting	<input type="checkbox"/> Active <input type="checkbox"/> Name <input type="checkbox"/> Speed / Duplex <input type="checkbox"/> Flow Control <input type="checkbox"/> Intrusion Lock
Advanced Application	<input type="checkbox"/> VLAN1q <input type="checkbox"/> VLAN1q Member <input type="checkbox"/> Bandwidth Control <input type="checkbox"/> Port Security <input type="checkbox"/> Broadcast Storm Control <input type="checkbox"/> Mirroring <input type="checkbox"/> Port Authentication <input type="checkbox"/> IGMP Filtering <input type="checkbox"/> Spanning Tree Protocol <input type="checkbox"/> Port-based VLAN

The following table describes the labels in this screen.

Table 70 Configure Clone

LABEL	DESCRIPTION
Source/ Destination Port	Enter the source port under the Source label. This port's attributes are copied. Enter the destination port or ports under the Destination label. These are the ports which are going to have the same attributes as the source port. You can enter individual ports separated by a comma or a range of ports by using a dash. Example: <ul style="list-style-type: none"> • 2, 4, 6 indicates that ports 2, 4 and 6 are the destination ports. • 2-6 indicates that ports 2 through 6 are the destination ports.
Basic Setting	Select which port settings (you configured in the Basic Setting menus) should be copied to the destination port(s).
Advanced Application	Select which port settings (you configured in the Advanced Application menus) should be copied to the destination ports.

Table 70 Configure Clone (continued)

LABEL	DESCRIPTION
Apply	Click Apply to save your changes to the switch's run-time memory. The switch loses these changes if it is turned off or loses power, so use the Save link on the top navigation panel to save your changes to the non-volatile memory when you are done configuring.
Cancel	Click Cancel to reset the fields.

CHAPTER 30

Introducing Commands

This chapter introduces commands and gives a summary of commands available.

30.1 Overview

In addition to the web configurator, you can use commands to configure the switch. Use commands for advanced switch diagnosis and troubleshooting. If you have problems with your switch, customer support may request that you issue some of these commands to assist them in troubleshooting.

Note: See the web configurator parts of this User's Guide for background information on features configurable by the web configurator.

30.2 Accessing the CLI

You can use a direct console connection or Telnet to access the command interpreter on the switch.

Note: The switch automatically logs you out of the management interface after five minutes of inactivity. If this happens to you, simply log back in again.

- By default, multiple command interpreter management sessions are allowed via either the console port or Telnet.
- Use the `configure no multi-login` command in the configuration mode to limit concurrent logins to only one.

30.2.1 The Console Port

Connect to the switch's console port using a terminal emulation software configured to the following settings:

- VT100 terminal emulation
- 9600 bps
- No parity
- 8 data bits
- 1 stop bit
- No flow control

30.2.1.1 Initial Screen

When you turn on your switch, it performs several internal tests as well as line initialization. You can view the initialization information using the console port. After the initialization, the login screen displays (refer to [Section 30.3 on page 184](#)).

```
Copyright (c) 1994 - 2006 ZyXEL Communications Corp.
initialize mgmt, ethernet address: 00:13:49:00:00:01
initialize switch, ethernet address: 00:13:49:00:00:02
Initializing switch unit 0...
Initializing VLAN Database...
Initializing IP Interface...
Initializing Advanced Applications...
Initializing Command Line Interface...
Initializing Web Interface...
Press ENTER to continue...
```

Use the following steps to telnet into your switch.

- 1 Make sure your computer IP address and the switch IP address are on the same subnet.
- 2 In Windows, click **Start** (usually in the bottom left corner), **Run** and then type `telnet 192.168.0.1` (the default management IP address) and click **OK**.
- 3 A login screen displays (refer to [Section 30.3 on page 184](#)).

30.3 The Login Screen

After you have successfully established a connection to the switch using a direct console connection or Telnet, a login screen displays as shown below. For your first login, enter the default administrator login username “admin” and password “1234”.

```
Enter User Name : admin
Enter Password : XXXX
```

30.4 Command Syntax Conventions

The rules of the commands are listed next.

- The command keywords are in `courier new` font.
- The required fields in a command are enclosed in angle brackets `<>`, for instance, `ping <ip>` means that you must specify an IP number for this command.
- The optional fields in a command are enclosed in square brackets `[]`, for instance, `configure snmp-server [contact <system contact>] [location <system location>]`

means that the contact and location fields are optional.

- “Command” refers to a command used in the command line interface (CLI command).
- The | symbol means “or”.
- The entry <cr> in the command lines refers to carriage return. Press [ENTER] or carriage return after a command to execute the command.
- Use the up or down arrow key to scroll through the command history list.
- You may enter a unique part of a command and press [TAB] to have the switch automatically display the full command. For example, if you enter “config” and press [TAB], the full command of “configure” automatically displays.
- Each interface refers to an Ethernet port on the switch. Commands configured after the interface command correspond to those ports.
- Type multiple ports or port ranges separated by a comma. Ranges of port numbers are typed separated by a dash.

30.5 Changing the Password

This command is used to change the password for Enable mode. By default the same password is used to enter the command line interface (CLI) and Enable and Config modes of the CLI.

The password you change with this command is required to enter Enable and Config modes of the CLI.

Syntax:

```
password <password>
```

where

```
password <password> = Specifies the new password (up to 32 alphanumeric characters)  
users have to type in to enter Enable and Config modes.
```

30.6 Privilege Levels

You can use a command whose privilege level is equal to or less than that of your login account. For example, if your login account has a privilege level of 12, you can use all commands with privilege levels from 0 to 12. 0 privilege level commands are available to all login accounts.

Note: If you use an external RADIUS server to authenticate users, you can use a VSA (Vendor Specific Attribute) to configure a privilege level for an account on the RADIUS server. See [Section 16.1.1.1 on page 117](#) for more information.

Use the following commands to specify privilege levels for login accounts.

Syntax:

```
logins username <username> password <password>
logins username <username> privilege <0-14>
```

where

`username <username>` = Specifies a new user (up to 32 alphanumeric characters). Enter a user name to change the settings of an existing account.

`password <password>` = Specifies the new password (up to 32 alphanumeric characters) for this user.

`privilege <0-14>` = Assigns a privilege level for the user.

30.7 Command Modes

There are three command modes: **User**, **Enable** and **Configure**. The modes (and commands) available to you depend on what level of privilege your account has. See [Section 30.6 on page 185](#) for more information on setting up privilege levels.

When you first log into the command interpreter with a read-only account (having a privilege of 0 to 12), the initial mode is the User mode. The User mode commands are a subset of Enable mode commands. The User mode command prompt ends with an angle bracket (>).

To enter Enable mode, type `enable` and enter the administrator password when prompted (the default is 1234). When you enter Enable mode, the command prompt changes to the pound sign (#). If you log into the command interpreter as an administrator you automatically enter Enable mode.

The following table describes command interpreter modes and how to access them.

Table 71 Command Interpreter Mode Summary

MODE	DESCRIPTION	HOW TO LOGIN/ ACCESS	PROMPT
User	Commands available in this mode are a subset of enable mode. You can perform basic tests and display general system information.	Default login level for a read-only account.	<code>sysname></code> The first part of the prompt is the system name. In the CLI examples in this User's Guide, the system name is always "sysname".
Enable	Commands available in this mode allow you to save configuration settings, reset configuration settings as well as display further system information. This mode also contains the <code>configure</code> command which takes you to config mode.	Default login level for accounts with a privilege of 13 or 14. Read-only accounts (with a privilege of 0-12) need to type the <code>enable</code> command and enter enable mode password.	<code>sysname#</code>

Table 71 Command Interpreter Mode Summary (continued)

MODE	DESCRIPTION	HOW TO LOGIN/ ACCESS	PROMPT
Config	Commands available in this mode allow you to configure settings that affect the switch globally.	Type <code>config</code> in enable mode.	<code>sysname(config)#</code>
Command modes that follow are sub-modes of the config mode and can only be accessed from within the config mode.			
Config-vlan	This is a sub-mode of the config mode and allows you to configure VLAN settings.	Type <code>vlan</code> followed by a number (between 1 to 4094). For example, <code>vlan 10</code> to configure settings for VLAN 10.	<code>sysname(config-vlan)#</code>
Config-interface	This is a sub-mode of the config mode and allows you to configure port related settings.	Type <code>interface port-channel</code> followed by a port number. For example, <code>interface port-channel 8</code> to configure port 8 on the switch.	<code>sysname(config-interface)#</code>
Config-mvr	This is a sub-mode of the config mode and allows you to configure multicast VLAN settings.	To enter MVR mode, enter <code>mvr</code> followed by a VLAN ID (between 1 and 4094). For example, enter <code>mvr 2</code> to configure multicast settings on VLAN 2.	<code>sysname(config-mvr)#</code>

Enter `exit` to quit from the current mode or enter `logout` to exit the command interpreter.

30.8 Getting Help

The system includes a help facility to provide you with the following information about the commands:

- List of available commands under a command group.
- Detailed descriptions of the commands.

30.8.1 List of Available Commands

Enter “help” to display a list of available commands and the corresponding sub commands.

```
sysname> help
  Commands available:

  help
  logout
  exit
  history
  enable
  show ip <cr>
  show hardware-monitor <C|F>
  show system-information
  ping <ip|host-name> <cr>
  ping <ip|host-name> [vlan <vlan-id>][..]
  ping help
  traceroute <ip|host-name> <cr>
  traceroute <ip|host-name> [vlan <vlan-id>][..]
  traceroute help
  ssh <1|2> <[user@]dest-ip> <cr>
  ssh <1|2> <[user@]dest-ip> [command </>]
sysname>
```

Enter “?” to display a list of commands you can use.

```
sysname> ?
  enable          Turn on privileged commands
  exit            Exit from the EXEC
  help            Description of the interactive help system
  history         Show a list of previously run commands
  logout          Exit from the EXEC
  ping            Exec ping
  show            Show system information
  ssh             SSH client
  traceroute      Exec traceroute
sysname>
```

Enter <command> help to display detailed sub commands and parameters.

```
sysname> ping help
  Commands available:

  ping <ip|host-name>
  <
  [ in-band|out-of-band|vlan <vlan-id> ]
  [ size <0-1472> ]
  [ -t ]
  >
sysname>
```

Enter `<command> ?` to display detailed help information about the sub commands and parameters.

```
sysname> ping ?
  <ip|host-name>      destination ip address
  help                Description of ping help
sysname>
```

30.9 Using Command History

The switch keeps a list of recently used commands available to you for reuse. You can use any commands in the history again by pressing the up (▲) or down (▼) arrow key to scroll through the previously used commands and press [ENTER]. Use the history command to display the list of commands.

```
sysname> history
  enable
  exit
  show ip
  history
sysname>
```

30.10 Saving Your Configuration

After you set the switch settings with the configuration commands, use the `write memory` command to save the changes permanently.

Note: The `write memory` command is not available in User mode.

You must save your changes after each CLI session. All unsaved configuration changes are lost once you restart the switch.

```
sysname# write memory
```

30.10.1 Switch Configuration File

When you configure the switch using either the CLI (Command Line Interface) or web configurator, the settings are saved as a series of commands in a configuration file on the switch. You can perform the following with a configuration file:

- Back up switch configuration once the switch is set up to work in your network.
- Restore switch configuration.

- Use the same configuration file to set all switches (of the same model) in your network to the same settings.

Note: You may also edit a configuration file using a text editor.

Make sure you use valid commands. The switch rejects configuration files with invalid or incomplete commands.

30.10.2 Logging Out

In User or Enable mode, enter the `exit` or `logout` command to log out of the CLI. In Config mode entering `exit` takes you out of the Config mode and into Enable mode and entering `logout` logs you out of the CLI.

30.11 Command Summary

The following sections summarize the commands available in the switch together with a brief description and privilege level of each command. Commands listed in the tables are in the same order as they are displayed in the CLI. See the related section in the User's Guide for more background information.

30.11.1 User Mode

The following table describes the commands available for User mode.

Table 72 Command Summary: User Mode

COMMAND		DESCRIPTION	PRIVILEGE
help		Displays help information.	0
logout		Exits from the CLI.	0
exit		Logs out from the CLI.	0
history		Displays a list of previously command(s) that you have executed. The switch stores up to 256 commands in history.	0
enable		Accesses Enable (or privileged) mode. See Section 30.11.2 on page 191 .	0
show	ip	Displays IP related information.	0
	hardware-monitor <C F>	Displays current hardware monitor information with the specified temperature unit (Celsius C or Fahrenheit F).	0
	system-information	Displays general system information.	0
ping	<IP host-name>	Sends Ping request to an Ethernet device.	0

Table 72 Command Summary: User Mode (continued)

COMMAND		DESCRIPTION	PRIVILEGE
	<IP host-name> [vlan <vlan-id>] [size <0-1472>] [-t]	Sends Ping request to an Ethernet device in the specified VLAN(s) with the specified parameters.	0
	help	Displays command help information.	0
traceroute	<ip host-name>	Determines the path a packet takes to a device.	0
	<ip host-name> [vlan <vlan-id>] [ttl <1-255>] [wait <1-60>] [queries <1-10>]	Determines the path a packet takes to a device in a VLAN.	0
	help	Displays command help information.	0
ssh	<1 2> <[user@]dest-ip>	Connects to an SSH server with the specified SSH version.	0

30.11.2 Enable Mode

The following table describes the commands available for Enable mode.

Table 73 Command Summary: Enable Mode

COMMAND		DESCRIPTION	LEVEL	
help		Displays help information.	13	
logout		Exits Enable (or privileged) mode.	13	
exit		Exits Enable (or privileged) mode.	13	
history		Displays a list of command(s) that you have previously executed.	13	
enable		Accesses Enable (or privileged) mode.	13	
disable		Exits Enable (or privileged) mode.	13	
configure		Accesses Configuration mode. See Section 30.11.3 on page 196 .	13	
no	logging	Clears system logs.	13	
	arp	Flushes the ARP (Address Resolution Protocol) table.	13	
	interface <port-number>	Clears the interface status of the specified port(s).	13	
show	ip	Displays IP related information.	13	
		arp	Displays the ARP table.	13
		tcp	Displays TCP related information.	13
		udp	Displays UDP related information.	13
		route	Displays IP routing information.	13

Table 73 Command Summary: Enable Mode (continued)

COMMAND		DESCRIPTION	LEVEL	
		<code>route static</code>	Displays IP static route information.	13
	<code>hardware-monitor</code> <code><C F></code>		Displays current hardware monitor information with the specified temperature unit (Celsius C or Fahrenheit F).	13
	<code>system-information</code>		Displays general system information.	13
	<code>vlan1q</code>	<code>gvrp</code>	Displays GVRP settings.	13
		<code>port-isolation</code>	Displays port isolation settings.	13
	<code>spanning-tree</code>	<code>config</code>	Displays Spanning Tree Protocol (STP) settings.	13
	<code>mac</code>	<code>address-table</code> <code><all</code> <code>[mac vid port]></code>	Displays MAC address table. You can sort by MAC address, VID or port.	13
		<code>address-table</code> <code>static</code>	Displays static MAC address table.	13
		<code>address-table</code> <code>count</code>	Displays the number of static MAC address tables.	13
	<code>lacp</code>		Displays LACP (Link Aggregation Control Protocol) settings.	13
	<code>trunk</code>		Displays link aggregation information.	13
	<code>radius-server</code>		Displays RADIUS server settings.	13
	<code>port-access-authenticator</code>		Displays all port authentication settings.	13
		<code><port-list></code>	Displays port authentication settings on the specified port(s).	13
	<code>port-security</code>		Displays all port security settings.	13
		<code><port-list></code>	Displays port security settings on the specified port(s).	13
	<code>snmp-server</code>		Displays SNMP settings.	13
	<code>logins</code>		Displays login account information.	13
	<code>service-control</code>		Displays service control settings.	13
	<code>remote-management</code>		Displays all secured client information.	13
		<code><index></code>	Displays the specified secured client information.	13
	<code>interface <port-list></code>		Displays current interface status.	13
	<code>interfaces</code> <code>config <port-list></code>		Displays current interface configuration on the port(s).	13

Table 73 Command Summary: Enable Mode (continued)

COMMAND		DESCRIPTION	LEVEL	
		bandwidth-control	Displays bandwidth control settings on the port(s).	13
		egress	Displays outgoing port information on the port(s).	13
		bstorm-control	Displays broadcast storm control settings on the port(s).	13
		igmp-immediate-leave	Displays IGMP immediate leave settings on the port(s).	13
		igmp-filtering	Displays IGMP filter profile settings on the port(s).	13
		igmp-group-limited	Displays IGMP group settings on the port(s).	13
		igmp-query-mode	Displays IGMP query mode settings on the port(s).	13
	vlan		Displays the status of all VLANs.	13
		<vlan-id>	Displays the status of the specified VLAN.	13
	running-config		Displays current operating configuration.	13
		help	Displays detailed information and parameters for this command.	13
		interface port-channel <port-list> [bandwidth-limit...]	Displays current operating configuration on a port by port basis. Optionally specifies which settings are displayed.	13
	timesync		Displays time server information.	13
	time		Displays current system time and date.	13
	garp		Displays GARP information.	13
	loginPrecedence		Displays login precedence settings.	13
	logging		Displays system logs.	13
	ssh		Displays general SSH settings.	13
		known-hosts	Displays known SSH hosts information.	13
		key <rsa rsa dsa>	Displays internal SSH public and private key information.	13
		session	Displays current SSH session(s).	13
	https		Displays the HTTPS information.	13
		session	Displays current HTTPS session(s).	13
		certificate	Displays the HTTPS certificates.	13
		key <rsa dsa>	Displays the HTTPS key.	13

Table 73 Command Summary: Enable Mode (continued)

COMMAND		DESCRIPTION	LEVEL	
		timeout	Displays the HTTPS session timeout.	13
	multi-login		Displays multi-login information	13
	plt		Displays Packet Loop Test (PLT).	13
	mac-aging-time		Displays MAC learning aging time.	13
	cluster		Displays cluster management status.	13
		candidates	Displays cluster candidate information.	13
		member	Displays the MAC address of the cluster member(s).	13
		member mac <mac-addr>	Displays the status of the cluster member(s).	13
		members config	Displays the configuration of the cluster member(s).	13
	igmp-filtering profile		Displays IGMP filter profile settings.	13
	igmp-snooping		Displays IGMP snooping settings.	13
	multicast		Displays multicast settings.	13
	mvr		Displays all MVR (Multicast VLAN Registration) settings.	13
		<vlan-id>	Displays specified MVR information.	13
	diffserv		Displays DiffServ settings on the switch.	13
	pwr		Displays PoE (Power over Ethernet settings on the switch). Only available on the ES-2108PWR model).	13
igmp-flush			Removes all IGMP information.	13
kick tcp	<Session ID>		Resets a TCP connection. Use the show ip tcp command to get the Session ID.	13
mac-flush			Clears the MAC address table.	13
	<port-num>		Removes all learned MAC address on the specified port(s).	13
erase	running-config		Resets to the factory default settings.	13
		interface port- channel <port- list> [bandwidth- limit...]	Resets to the factory default settings on a per port basis and optionally on a per feature configuration basis.	13

Table 73 Command Summary: Enable Mode (continued)

COMMAND		DESCRIPTION	LEVEL	
baudrate	<1 2 3 4 5>	Changes the console port speed. Choices are 1 (9600), 2 (19200), 3(38400), 4 (57600) and 5 (115200).	13	
boot	config <index>	Restarts the system with the specified configuration file.	13	
reload	config <index>	Restarts the system and use the specified configuration file.	13	
write	memory	Saves current configuration to the configuration file the switch is currently using.	13	
		<index>	Saves current configuration to the specified configuration file on the switch.	13
copy	tftp flash <ip> <remote-file>	Restores firmware via TFTP.	13	
	tftp config <index> <ip> <remote-file>	Restores configuration with the specified filename from the specified TFTP server.	13	
	running-config tftp <ip> <remote-file>	Backs up running configuration to the specified TFTP server with the specified file name.	13	
	running-config interface port- channel <port> <port-list>	Clones (copies) the attributes from the specified port to other ports.	13	
	running-config interface port- channel <port> <port-list>	[bandwidth- limit]	Copies the specified attributes from one port to other ports.	13
cable- diagnostic s	<port-list>	Performs a basic connectivity test on the ports. Displays "OK" if connector is inserted in the port, "Open" if no connector is inserted in the port or "Unknown" if this test cannot determine the status.	13	
ping	<ip host-name>	Sends Ping request to an Ethernet device.	13	
		[vlan <vlan- id>] [...]	Sends Ping request to an Ethernet device in the specified VLAN(s).	13
	help	Displays command help information.	13	

Table 73 Command Summary: Enable Mode (continued)

COMMAND		DESCRIPTION	LEVEL
traceroute	<ip host-name> [in-band out-of-band vlan <vlan-id>][ttl <1-255>] [wait <1-60>] [queries <1-10>]	Determines the path a packet takes to a device.	13
	help	Displays command help information.	13
ssh	<1 2> <[user@]dest-ip>	Connects to an SSH server with the specified SSH version.	13
		[command </>]	13
		Connects to an SSH server with the specified SSH version and addition commands to be executed on the server.	13

30.11.3 General Configuration Mode

The following table lists the commands in Configuration (or Config) mode.

Table 74 Command Summary: Configuration Mode

COMMAND		DESCRIPTION	PRIVILEGE	
help		Displays help information.	13	
logout		Exits from the CLI.	13	
history		Displays a list of previous command(s) that you have executed.	13	
exit		Exits from Config mode into Enable mode.	13	
mode	zynos	Changes the CLI mode to the Zynos format.	13	
password	<password>	Change the password for accessing Enable mode.	14	
no	ip	Sets the management IP address to the default value.	13	
		route <ip> <mask>	Removes a specified IP static route.	13
		route <ip> <mask> inactive	Enables a specified IP static route.	13
	igmp-filtering		Clears the IGMP filtering settings on the switch.	13
		profile <name>	Deletes the IGMP filtering profile.	13

Table 74 Command Summary: Configuration Mode (continued)

COMMAND			DESCRIPTION	PRIVILEGE
		profile <name> start-address <ip> end- address <ip>	Deletes a rule in the IGMP filtering profile.	13
	igmp-snooping		Disables IGMP snooping.	13
	mac-forward	mac <mac-addr> vlan <vlan-id> interface <interface-id>	Removes the specified MAC forwarding entry, belonging to a VLAN group (if any) forwarded through an interface(s).	13
		mac <mac-addr> vlan <vlan-id> interface <interface-id> inactive	Enables the specified MAC address, belonging to a VLAN group (if any) forwarded through an interface(s).	13
	mac-filter	mac <mac-addr> vlan <vlan-id> inactive	Enables the specified MAC-filter rule.	13
		mac <mac-addr> vlan <vlan-id>	Disables the specified MAC filter rule.	13
	mirror-port		Disables port mirroring on the switch.	13
	lacp		Disables the link aggregation control protocol (dynamic trunking) on the switch.	13
	trunk	<T1 T2>	Disables the specified trunk group.	13
		<T1 T2> lacp	Disables LACP in the specified trunk group.	13
		<T1 T2> interface <port-list>	Removes ports from the specified trunk group.	13
	storm-control		Disables storm control on the switch.	13
	bandwidth-control		Disable bandwidth control on the switch.	13
	vlanlq	gvrp	Disables GVRP on the switch.	13
		port-isolation	Disables port isolation.	13
		ingress-check	Disable ingress checking on the switch.	13
	spanning-tree		Disables STP.	13
		<port-list>	Disables STP on listed ports.	13
	timesync			13

Table 74 Command Summary: Configuration Mode (continued)

COMMAND			DESCRIPTION	PRIVILEGE
	radius-server	<index>	Disables the use of authentication from the specified RADIUS server.	13
	port-access-authenticator		Disables port authentication on the switch.	13
		<port-list>	Disables authentication on the listed ports.	13
		<port-list> reauthenticate	Disables the re-authentication mechanism on the listed port(s).	13
	port-security		Disables port security on the switch.	13
		<port-list>	Disables port security on the specified ports.	13
		<port-list> learn inactive	Enables MAC address learning on the specified ports.	13
	snmp-server	trap-destination <ip>	Disables sending of SNMP traps to a station.	13
	logins	username <name>	Disables login access to the specified name.	14
	service-control	telnet	Disables telnet access to the switch.	13
		ftp	Disables FTP access to the switch.	13
		http	Disables web browser control to the switch.	13
		ssh	Disables SSH (Secure Shell) server access to the switch.	13
		https	Disables secure web browser access to the switch.	13
		icmp	Disables ICMP access to the switch such as pinging and tracerouting.	13
		snmp	Disables SNMP management.	13
	remote-management	<index>	Clears a secure client set entry from the list of secure clients.	13
		<index> service <[telnet] [ftp] [http] [icmp] [snmp] [ssh] [https]>	Disables a secure client set entry number from using the selected remote management service(s).	13
	vlan	<vlan-id>	Deletes the static VLAN entry.	13

Table 74 Command Summary: Configuration Mode (continued)

COMMAND			DESCRIPTION	PRIVILEGE
	ssh	key <rsa1 rsa dsa>	Disables the secure shell server encryption key. Your switch supports SSH versions 1 and 2 using RSA and DSA authentication.	13
		known-hosts	Removes all remote hosts.	13
		known-hosts <host-ip>	Removes the specified remote host from the list of all known hosts.	13
		known-hosts <host-ip> [1024 ssh- rsa ssh-dsa]	Removes remote known hosts with the specified public key (1024-bit RSA1, RSA or DSA).	13
	https	timeout	Resets the session timeout to the default of 300 seconds.	13
	multi-login		Disables another administrator from logging into Telnet.	14
	cluster		Disables cluster management on the switch.	13
	cluster member	<mac-address>	Removes the cluster member.	13
	mvr	<vlan-id>	Disables MVR on the switch.	13
	syslog		Disables syslog logging.	13
		server <ip- address>	Disables syslog logging to the specified syslog server.	13
		server <ip- address> inactive	Enables syslog logging to the specified syslog server.	13
		type [type]	Disables syslog logging for the specified log type (<i>sys</i> , <i>link</i> , <i>config</i> , <i>error</i> or <i>report</i>).	13
	pwr interface <port-list>		Disable PoE on the specified ports. (ES-2108PWR only)	13
	pwr mibtrap		Disables mibtraps. (ES-2108PWR only)	13
vlan	<1-4094>		Enters the VLAN configuration mode. See Section 30.11.5 on page 209 for more information.	
vlan-type	<802.1q port- based>		Specifies the VLAN type.	13
igmp- snooping			Enables IGMP snooping.	13
	8021p-priority <0-7>		Sets the IEEE 802.1p priority values for IGMP control traffic.	13
	host-timeout	<1-16711450>	Sets the host timeout value.	13

Table 74 Command Summary: Configuration Mode (continued)

COMMAND			DESCRIPTION	PRIVILEGE
	leave-timeout	<1-16711450>	Sets the leave timeout value	13
	unknown-multicast-frame <drop flooding>		Sets how to treat traffic from unknown multicast group.	13
igmp-filtering			Enables IGMP filtering on the switch.	13
	profile <name> start-address <ip> end-address <ip>		Sets the range of multicast address(es) in a profile.	13
interface	port-channel <port-list>		Enables a port or a list of ports for configuration. See Section 30.11.4 on page 206 for more details.	13
spq			Sets the queuing method to SPQ (Strictly Priority Queuing).	13
wrr			Sets the queuing method to WRR (Weighted Round Robin).	13
	<wt1> <wt2> <wt3> <wt4>		Sets the weight value from 1 to 8 to each variable. These values are used in WRR queuing.	13
ip	route	<ip> <mask> <next-hop-ip>	Creates a static route.	13
		<ip> <mask> <next-hop-ip> [metric <metric>] [name <name>] [inactive]	Sets the metric of a static route or deactivates a static route.	13
	name-server	<ip>	Sets the IP address of a domain name server.	13
	address default-gateway	<ip>	Sets the default gateway's IP address for the out-of-band management port.	13
	address	<ip> <mask>	Sets the IP address and subnet mask of the out-of-band management port.	13
mac-forward	name <name> mac <mac-addr> vlan <vlan-id> interface <interface-id>		Configures a static MAC address forwarding rule.	13
		inactive	Disables a static MAC address forwarding rule.	13

Table 74 Command Summary: Configuration Mode (continued)

COMMAND			DESCRIPTION	PRIVILEGE
mac-filter	name <name> mac <mac-addr> vlan <vlan-id> drop <src/dst/both>		Configures a static MAC address port filtering rule.	13
		inactive	Disables a static MAC address port filtering rule.	13
mirror-port			Enables port mirroring.	13
	<port-num>		Sets a monitor port (the port to which traffic is copied for analysis).	13
mirror-filter	ingress	type <all dest src>	Specifies whether all incoming traffic is copied from the mirrored port or whether traffic going to or coming from a specific MAC address is copied.	13
		mac <mac-addr>	Specifies the destination MAC address or the source MAC address of the device which traffic will be copied.	13
	egress	type <all des src>	Specifies whether all outgoing traffic is copied from the mirrored port or whether traffic going to or coming from a specific MAC address is copied.	13
		mac <mac-addr>	Specifies the destination MAC address or the source MAC address of the device which traffic will be copied.	13
lacp			Enables Link Aggregation Control Protocol (LACP).	13
	system-priority	<1-65535>	Sets the priority of an active port using LACP.	13
trunk	<T1 T2>		Activates a trunk group.	13
	<T1 T2> lacp		Enables LACP for a trunk group.	13
	<T1 T2> interface <port-list>		Adds a port(s) to the specified trunk group.	13
	interface <port-list> timeout <lacp-timeout>		Defines the port number and LACP timeout period.	13
cluster	<vlan-id>		Sets the cluster management VLAN ID.	13
	name <cluster name>		Configures a name to identify the cluster manager.	13

Table 74 Command Summary: Configuration Mode (continued)

COMMAND		DESCRIPTION	PRIVILEGE	
	member <mac-address> password <password-str>		Sets the cluster member switch's hardware MAC address and password.	13
	rcommand <mac-address>		Logs into a cluster member switch.	13
radius-server	host <index> <ip>		Specifies the IP address of RADIUS server 1 or RADIUS server 2 (index =1 or index =2).	13
		[auth-port <socket-number>] [key <key-string>]	Sets the port number and key of the external RADIUS server.	13
	timeout <1-1000>		Specifies the RADIUS server timeout value.	13
	mode	<priority round-robin>	Specifies the mode for RADIUS server selection.	13
port-access-authenticator			Enables 802.1x authentication on the switch.	13
	<port-list>		Enables 802.1x authentication on the specified port(s).	13
		reauthenticate	Sets a subscriber to periodically re-enter his or her username and password to stay connected to a specified port.	13
		reauth-period <reauth-period>	Specifies how often a client has to re-enter the username and password to stay connected to the specified port(s).	13
port-security			Enables port security on the switch.	13
	<port-list>		Enables the port security feature on the specified port(s).	13
		learn inactive	Disables MAC address learning on the specified port(s).	13
		address-limit <number>	Limits the number of (dynamic) MAC addresses that may be learned on a port.	13

Table 74 Command Summary: Configuration Mode (continued)

COMMAND		DESCRIPTION	PRIVILEGE
	MAC-freeze	Disables MAC address learning and enables port security. Note: All previously learned dynamic MAC addresses are saved to the static MAC address table.	13
vlan1q	gvrp	Enables GVRP.	13
	port-isolation	Enables port-isolation.	13
	ingress-check	Enables ingress checking on the switch.	13
garp	join <100-65535> leave <msec> leaveall <msec>	Configures GARP time settings.	13
spanning-tree		Enables STP on the switch.	13
	priority <0-61440>	Sets the bridge priority of the switch.	13
	hello-time <1-10> maximum-age <6-40> forward-delay <4-30>	Sets Hello Time, Maximum Age and Forward Delay.	13
	<port-list>	Enables STP on a specified port.	13
	<port-list> path-cost <1-65535>	Sets the STP path cost for a specified port.	13
	<port-list> priority <0-255>	Sets the priority for a specified port.	13
	help	Displays help information.	13
hostname	<name_string>	Sets the switch's name for identification purposes.	13
time	<Hour:Min:Sec>	Sets the time in hour, minute and second format.	13
	timezone <-1200 ... 1200>	Selects the time difference between UTC (formerly known as GMT) and your time zone.	13
	date <month/day/year>	Sets the date in year, month and day format.	13
	help	Displays help information.	13

Table 74 Command Summary: Configuration Mode (continued)

COMMAND		DESCRIPTION	PRIVILEGE	
timesync	<daytime time ntp>	Sets the time server protocol.	13	
	server <ip>	Sets the IP address of your time server.	13	
loginPrecedence	<LocalOnly LocalRADIUS RADIUSOnly>	Select which database the switch should use (first) to authenticate a user.	14	
queue	priority <0-7> level <0-3>	Sets the priority level-to-physical queue mapping.	13	
storm-control		Enables broadcast storm control on the switch.	13	
bandwidth-control		Enables bandwidth control.	13	
mac-aging-time	<10-3000>	Sets learned MAC aging time.	13	
snmp-server	get-community <property>	Sets the get community.	13	
	set-community <property>	Sets the set community.	13	
	trap-community <property>	Sets the trap community.	13	
	trap-destination <ip>	Sets the IP addresses of up to four stations to send your SNMP traps to.	13	
	[contact <system contact>] [location <system location>]	Sets the geographic location and the name of the person in charge of this switch.	13	
logins	username <name> password <pwd>	Configures a default (read-only) account.	14	
	username <name>	privilege <0-14>	Assigns a privilege level to user accounts.	14
service-control	icmp	Allows ICMP access for services such as Ping.	13	
	snmp	Allows SNMP management.	13	
	http <socket- number> <timeout>	Allows HTTP access on the specified service port and defines the timeout period.	13	
	telnet <socket- number>	Allows Telnet access on the specified service port.	13	
	ftp <socket- number>	Allows FTP access on the specified service port.	13	

Table 74 Command Summary: Configuration Mode (continued)

COMMAND			DESCRIPTION	PRIVILEGE
	ssh <socket-number>		Allows SSH access on the specified service port.	13
	https <socket-number>		Allows HTTPS access on the specified service port.	13
remote-management	<index>		Enables a specified secured client set.	13
	<index> start-addr <ip> end-addr <ip> service <[telnet] [ftp] [http] [icmp] [snmp] [ssh] [https]>		Specifies a group of trusted computer(s) from which an administrator may use a service to manage the switch.	13
admin-password	<pw-string> <confirm-string>		Changes the administrator password.	14
syslog			Enables syslog logging on the switch.	13
	server <ip-address>		Enables syslog logging on the specified syslog server.	
	server <ip-address>	inactive	Disables syslog logging to the specified syslog server.	13
		level [0 ~ 7]	Sets the IP address of the syslog server and the severity level.	13
	type <type> facility [local 1 ..7]		Sets the log type and the file location on the syslog server.	13
ssh	known-hosts <host-ip> <1024 ssh-rsa ssh-dsa> <key>		Adds a remote host to which the switch can access using SSH service.	13
https	cert-regeneration <rsa dsa>		Re-generates a certificate.	13
	timeout <0-65535>		Sets the HTTPS timeout period.	13
multi-login			Enables multi-login.	14
mvr <vlan-id>			Enters the MVR (Multicast VLAN Registration) configuration mode. See Section 30.11.6 on page 210 for more information.	13
diffserv			Enables DiffServ on the switch.	13

Table 74 Command Summary: Configuration Mode (continued)

COMMAND			DESCRIPTION	PRIVILEGE
	dscp <0-63>	priority <0-7>	Maps DSCP value with an 802.1p value.	13
pwr	interface <port-list>		Enables PoE (Power over Ethernet) on the specified ports.	13
	usagethreshold <1-99>		Sets the percentage of power usage which initiates mib traps.	13
	mibtrap		Enables mib traps on the switch. Traps are initiated when the usage reaches the limit set up by the usagethreshold command.	13

30.11.4 interface port-channel Commands

The following table lists the `interface port-channel` commands in configuration mode. Use these commands to configure the ports.

Table 75 interface port-channel Commands

COMMAND			DESCRIPTION	PRIVILEGE
interface port-channel <port-list>			Enables a port or a list of ports for configuration.	13
	egress set <port-list>		Sets the outgoing traffic port list for a port-based VLAN.	13
	igmp-immediate-leave		Enables IGMP immediate leave on the port.	13
	igmp-filtering profile <name>		Sets the IGMP filtering profile for this port.	13
	igmp-group-limited		Limits the number of multicast groups.	13
	igmp-group-limited number <number>		Sets the number of multicast groups this port is allowed to join.	13
	igmp-querier-mode <auto fixed edge>		Sets the IGMP querier mode of a port. Selects <code>auto</code> to treat the IGMP queries normally, <code>fixed</code> to always treat the port as a querier port no matter there is a query or <code>edge</code> to treat the port as a non-querier port which drops any IGMP queries received.	13

Table 75 interface port-channel Commands (continued)

COMMAND		DESCRIPTION	PRIVILEGE	
	pvid <1-4094>	The default PVID is VLAN 1 for all ports. Sets a PVID in the range 1 to 4094 for the specified interface.	13	
	gvrp	Enables this function to permit VLAN groups beyond the local switch.	13	
	frame-type <all tagged>	Choose to accept both tagged and untagged incoming frames or just tagged incoming frames on a port.	13	
	name <port-name-string>	Sets a name for the port(s). Enter a descriptive name (up to nine printable ASCII characters).	13	
	vlan-trunking	Enables VLAN Trunking on ports connected to other switches or routers (but not ports directly connected to end users) to allow frames belonging to unknown VLAN groups to pass through the switch.	13	
	flow-control	Enables interface flow control. Flow control regulates transmissions to match the bandwidth of the receiving port.	13	
	bandwidth-limit	Enables ingress (pir), cir and egress limits on the port(s).	13	
		ingress	Enables limits for incoming traffic on the port(s).	13
		ingress <Kbps>	Sets the maximum bandwidth allowed for incoming traffic on the port(s).	13
		egress	Enables bandwidth limits allowed for outgoing traffic on the port(s).	13
		egress <Kbps>	Sets the maximum bandwidth allowed for outgoing traffic on the port(s).	13
	bmstorm-limit	Enables broadcast storm limits on the switch.	13	
		<Kbps>	Specifies the maximum amount of bandwidth allowed for broadcast traffic.	13
	diffserv	Enables DiffServ on the port(s).	13	
	qos priority	<0 .. 7>	Sets the quality of service priority for an interface.	13
	mirror		Enables port mirroring in the interface.	13
		dir <ingress egress both>	Enables port mirroring for incoming, outgoing or both incoming and outgoing traffic. Port mirroring copies traffic from one or all ports to another or all ports for external analysis.	13

Table 75 interface port-channel Commands (continued)

COMMAND		DESCRIPTION	PRIVILEGE
	speed-duplex	<auto 10-half 10-full 100-half 100-full 1000-full>	13
	no	egress set <port-list>	13
		igmp-immediate-leave	13
		igmp-filtering profile	13
		igmp-group-limited	13
		gvrp	13
		flow-control	13
		vlan-trunking	13
		mirror	13
		diffserv	13
		bandwidth-limit	13
		bmstorm-limit	13
		inactive	13
		intrusion-lock	13
	inactive		13
	help		13
	exit		13
	intrusion-lock		13
	test		13

30.11.5 config-vlan Commands

The following table lists the `vlan` commands in configuration mode.

Table 76 Command Summary: config-vlan Commands

COMMAND			DESCRIPTION	PRIVILEGE
<code>vlan <1-4094></code>			Creates a new VLAN group.	13
	<code>name <name-str></code>		Specifies a name for identification purposes.	13
	<code>normal <port-list></code>		Specifies the port(s) to dynamically join this VLAN group using GVRP	13
	<code>fixed <port-list></code>		Specifies the port(s) to be a permanent member of this VLAN group.	13
	<code>forbidden <port-list></code>		Specifies the port(s) you want to prohibit from joining this VLAN group.	13
	<code>untagged <port-list></code>		Specifies the port(s) you don't want to tag all outgoing frames transmitted with this VLAN Group ID.	13
	<code>inactive</code>		Disables the specified VLAN.	13
	<code>help</code>		Displays a list of available VLAN commands.	13
	<code>no</code>	<code>fixed <port-list></code>	Sets fixed port(s) to normal port(s).	13
		<code>forbidden <port-list></code>	Sets forbidden port(s) to normal port(s).	13
		<code>untagged <port-list></code>	Enables VLAN tagging for outgoing traffic on the specified port(s).	13
		<code>inactive</code>	Enables the specified VLAN.	13
		<code>ip address default-management dhcp-bootp</code>	Sets the default in-band interface to use a static IP address in this VLAN. The switch will use the default IP address of 0.0.0.0 if you do not configure a static IP address.	13
		<code>ip address <ip-address> <mask></code>	Deletes the IP address and subnet mask from this VLAN.	13
		<code>ip address default-gateway</code>	Deletes the default gateway from this VLAN.	13
	<code>exit</code>		Leaves the VLAN configuration mode.	13
	<code>ip address</code>	<code>default-management dhcp-bootp</code>	Sets the dynamic in-band IP address	13

Table 76 Command Summary: config-vlan Commands (continued)

COMMAND		DESCRIPTION	PRIVILEGE
	default-management dhcp-bootp release	Releases the dynamic in-band IP address.	13
	default-management dhcp-bootp renew	Updates the dynamic in-band IP address.	13
	default-management <ip-address> <mask>	Sets a static in-band IP address and subnet mask.	13
	<ip-address> <mask> manageable	Sets the management IP address and subnet mask of the switch in the specified VLAN.	13
	<ip-address> <mask>	Sets the IP address and subnet mask of the switch in the specified VLAN.	13
	default-gateway <ip-address>	Sets a default gateway IP address for this VLAN.	13

30.11.6 mvr Commands

The following table lists the `mvr` commands in configuration mode.

Table 77 mvr Commands

COMMAND		DESCRIPTION	PRIVILEGE
mvr <1-4094>		Enters the MVR (Multicast VLAN Registration) configuration mode.	13
	source-port <port-list>	Sets the source port(s). An MVR source port can send and receive multicast traffic in a multicast VLAN.	13
	receiver-port <port-list>	Sets the receiver port(s). An MVR receiver port can only receive multicast traffic in a multicast VLAN.	13
	inactive	Disables MVR settings.	13
	mode <dynamic compatible>	Sets the MVR mode (dynamic or compatible).	13
	name <name-str>	Sets the MVR name for identification purposes.	13
	tagged <port-list>	Sets the port(s) to tag VLAN tags.	13

Table 77 mvr Commands (continued)

COMMAND		DESCRIPTION	PRIVILEGE
	group <name-str> start-address <ip> end-address <ip>	Sets the multicast group range for the MVR.	13
	exit	Exit from the MVR configuration mode.	13
	8021p-priority <0-7>	Sets a priority level (0-7) to which the switch changes the priority in outgoing IGMP control packets.	13
	no source-port <port-list>	Disables the source port(s). An MVR source port can send and receive multicast traffic in a multicast VLAN.	13
	no receiver-port <port-list>	Disables the receiver port(s). An MVR receiver port can only receive multicast traffic in a multicast VLAN.	13
	no tagged <port-list>	Sets the port(s) to untag VLAN tags.	13
	no inactive	Enables MVR.	13
	no group	Disables all MVR group settings.	13
	no group <name-str>	Disables the specified MVR group setting.	13

CHAPTER 31

User and Enable Mode Commands

This chapter describes some commands which you can perform in the User and Enable modes.

31.1 Overview

The following command examples show how you can use User and Enable modes to diagnose and manage your switch.

31.2 show Commands

These are the commonly used `show` commands.

31.2.1 show system-information

Syntax:

```
show system-information
```

This command shows the general system information (such as the firmware version and system up time).

An example is shown next.

```
sysname# show system-information
System Name           : ES-2108-G
System Contact        :
System Location       :
Ethernet Address      : 00:13:49:00:00:01
ZyNOS F/W Version     : V3.70 (ABL.0)b0 | 05/29/2006
RomRasSize           : 1457964
System up Time        : 1:43:26 (9784d ticks)
Bootbase Version      : V1.01 | 09/02/2005
ZyNOS CODE            : RAS May 29 2006 19:16:36
Product Model         : ES-2108-G
```

31.2.2 show ip

Syntax:

```
show ip
```

This command displays the IP related information (such as IP address and subnet mask) on all switch interfaces.

The following figure shows the default interface settings.

```
sysname> show ip
IP Interface
   IP[192.168.1.1], Netmask[255.255.255.0], VID[1]
sysname>
```

31.2.3 show logging

Syntax:

```
show logging
```

This command displays the system logs. The following figure shows an example.

```
sysname# show logging
 1 Thu Jan  1 00:02:08 1970 PP05 -WARN  SNMP TRAP 3: link up
 2 Thu Jan  1 00:03:14 1970          INFO  adjtime task pause 1 day
 3 Thu Jan  1 00:03:16 1970 PP0f -WARN  SNMP TRAP 26: Event On Trap
 4 Thu Jan  1 00:03:16 1970 PINI -WARN  SNMP TRAP 1: warm start
 5 Thu Jan  1 00:03:16 1970 PINI -WARN  SNMP TRAP 3: link up
 6 Thu Jan  1 00:03:16 1970 PINI  INFO  main: init completed
 7 Thu Jan  1 00:00:13 1970 PP26  INFO  adjtime task pause 1 day
 8 Thu Jan  1 00:00:14 1970 PP0f -WARN  SNMP TRAP 26: Event On Trap
 9 Thu Jan  1 00:00:14 1970 PINI -WARN  SNMP TRAP 0: cold start
10 Thu Jan  1 00:00:14 1970 PINI  INFO  main: init completed
11 Thu Jan  1 00:00:04 1970 PP05 -WARN  SNMP TRAP 3: link up
11 Thu Jan  1 00:00:04 1970 PP05 -WARN  SNMP TRAP 3: link up
Clear Error Log (y/n):
```

Note: If you clear a log (by entering `y` at the `Clear Error Log (y/n) :` prompt), you cannot view it again.

31.2.4 show interface

Syntax:

```
show interface [port-number]
```

This command displays statistics of a port. The following example shows that port 2 is up and the related information.

```

sysname# show interface 2
  Port Info      Port NO.      :2
                Link          :100M/F
                Status       :FORWARDING
                LACP         :Disabled
                TxPkts       :0
                RxPkts       :63
                Errors       :0
                Tx KBs/s     :0.0
                Rx KBs/s     :0.0
                Up Time      :0:02:33
TX Packet      Tx Packets    :0
                Multicast    :0
                Broadcast    :0
                Pause        :0
                Tagged       :0
RX Packet      Rx Packets    :63
                Multicast    :0
                Broadcast    :63
                Pause        :0
TX Collison    Single         :0
                Multiple     :0
                Excessive    :0
                Late         :0
Error Packet   RX CRC        :0
                Runt         :0
Distribution   64           :3
                65 to 127   :44
                128 to 255  :14
                256 to 511  :2
                512 to 1023 :0
                1024 to 1518 :0
                Giant       :0
sysname#

```

31.2.5 show mac address-table

Syntax:

```
show mac address-table <all <sort>|static>
```

Where

<sort> = Specifies the sorting criteria (MAC, VID or port).

This command displays the MAC address(es) stored in the switch. The following example shows the static MAC address table.

```
sysname# show mac address-table static
Port      VLAN ID      MAC Address      Type
CPU       1            00:a0:c5:01:23:46  Static
sysname#
```

31.3 ping

Syntax:

```
ping <ip|host-name> <vlan <vlan-id> [ size <0-1472> ] [ -t ]>
```

where

<ip|host-name> = The IP address or host name of an Ethernet device.
vlan <vlan-id> = Specifies the network interface or the VLAN ID to which the Ethernet device belongs.

This command sends Ping packets to an Ethernet device. The following example sends Ping requests to and displays the replies from an Ethernet device with an IP address of 192.168.1.100.

```
sysname# ping 192.168.1.100
sent rcvd rate rtt avg mdev max min reply from
  1   1  100   0   0   0   0   0 192.168.1.100
  2   2  100   0   0   0   0   0 192.168.1.100
  3   3  100   0   0   0   0   0 192.168.1.100
sysname#
```

31.4 traceroute

Syntax:

```
traceroute <ip|host-name> vlan <vlan-id>
```

where

<ip|host-name> = The IP address or host name of an Ethernet device.
vlan <vlan-id> = Specifies the network interface or the VLAN ID to which the Ethernet device belongs.

This command displays information about the route to an Ethernet device. The following example displays route information to an Ethernet device with an IP address of 192.168.1.100.

```
sysname> traceroute 192.168.1.100
traceroute to 192.168.1.100, 30 hops max, 40 byte packet
 1:192.168.1.100 (10 ms) (10 ms) (0 ms)
traceroute done:
sysname>
```

31.5 Copy Port Attributes

Use the `copy running-config` command to copy attributes of one port to another port or ports.

Syntax:

```
copy running-config interface port-channel <port> <port-list>
copy running-config interface port-channel <port> <port-list>
-> [active] [name] [speed-duplex] [bpdu-control] [flow-control]
-> [intrusion-lock] [vlanlq] [vlanlq-member] [bandwidth-limit]
-> [bmstorm-control] [mirroring] [port-access-authenticator]
-> [queuing-method] [igmp-filtering] [spanning-tree] [port-based-vlan]
```

where

```
copy running-config interface port-channel <port> <port-list> = Copies all of the possible attributes from one port to another port or ports.
copy running-config interface port-channel <port> <port-list> [active] = Copies only the specified port attributes from one port to another port or ports.
... ]
```

An example is shown next.

- Copy all attributes of port 1 to port 2
- Copy selected attributes (active, bandwidth limit and STP settings) to ports 5-8

```
sysname# copy running-config interface port-channel 1 2
sysname# copy running-config interface port-channel 1 5-8 active
-> bandwidth-limit spanning-tree
```

31.5.1 Resetting to the Factory Default

Follow the steps below to reset the switch back to the factory defaults.

- 1 Enter `erase running config` to reset the current running configuration.
- 2 Enter `write memory` to save the changes to the current configuration file.

The following example resets the configuration file to the factory default settings.

```
sysname# erase running-config
sysname# write memory
```

CHAPTER 32

Configuration Mode Commands

This chapter describes how to enable and configure your switch's features using commands. For more background information, see the feature specific chapters which proceed the commands chapters.

32.1 Enabling IGMP Snooping

To enable IGMP snooping on the switch. Enter `igmp-snooping` and press [ENTER]. You can also set how to treat traffic from an unknown multicast group by typing the `unknown-multicast-frame` parameter.

Syntax:

```
igmp-snooping
igmp-snooping host-timeout <1-16711450>
igmp-snooping leave-timeout <1-16711450>
igmp-snooping unknown multicast-frame <drop|flooding>
```

where

<code>igmp-snooping</code>	=	Enables IGMP snooping on the switch.
<code>host-timeout <1-16711450></code>	=	Specifies the time out period of the switch with respect to IGMP report queries. If an IGMP report for a multicast group was not received for a host-timeout period, from a specific port, this port is deleted from the member list of that multicast group.
<code>leave-timeout <1-16711450></code>	=	Specifies the time that the switch will wait for multicast members to respond to a leave report. If no response happens in the timeout period, the switch deletes the port from the multicast group.
<code>igmp-snooping unknown multicast-frame <drop flooding></code>	=	Specifies whether you want to discard packets from unknown multicast groups or whether you want to forward them to all ports.

An example is shown next.

- Enable IGMP snooping on the switch.
- Set the `host-timeout` and `leave-timeout` values to 30 seconds

- Set the switch to drop packets from unknown multicast groups.

```
sysname(config)# igmp-snooping
sysname(config)# igmp-snooping host-timeout 30
sysname(config)# igmp-snooping leave-timeout 30
sysname(config)# igmp-snooping unknown-multicast-frame drop
```

32.2 Configure IGMP Filter

Use the following commands in the config mode to configure IGMP filtering profiles.

Syntax:

```
igmp-filtering
igmp-filtering profile <name> start-address <ip> end-address <ip>
```

where

`igmp-filtering` = Enables IGMP filtering on the switch

`profile <name>` = Specifies a name (up to 32 alphanumeric characters) for this IGMP profile. If you want to edit an existing IGMP profile enter the existing profile name followed by `start-address` and `end-address` parameters.

`start-address` = Specifies the starting multicast IP address for a range of multicast IP addresses that you want to belong to the IGMP filter profile. IP address in the range 224.0.0.0 to 239.255.255.255 are used for IP multicasting.

`end-address` = Specifies the ending multicast IP address for a range of multicast IP addresses that you want to belong to the IGMP filter profile. IP address in the range 224.0.0.0 to 239.255.255.255 are used for IP multicasting.

An example is shown next.

- Enable IGMP filtering on the switch.
- Create an IGMP filtering profile **filter1** and specify the multicast IP addresses in the range **224.255.255.0** to **225.255.255.255** to belong to this profile.

```
sysname(config)# igmp-filtering
sysname(config)# igmp-filtering profile filter1 start-address
224.255.255.0 -> end-address 225.255.255.255
```

32.3 Enabling STP

Use the `spanning-tree` commands to enable and configure STP on the switch.

Syntax:

```
spanning-tree
spanning-tree priority <0-61440>
spanning-tree hello-time <1-10> maximum-age <6-40> forward-delay <4-30>
spanning-tree <port-list> path-cost <1-65535>
spanning-tree <port-list> priority <0-255>
```

where

`spanning-tree` = Enables STP on the switch.

`priority <0-61440>` = Specifies the bridge priority for the switch. The lower the numeric value you assign, the higher the priority for this bridge.

Bridge priority is used in determining the root switch, root port and designated port. The switch with the highest priority (lowest numeric value) becomes the STP root switch. If all switches have the same priority, the switch with the lowest MAC address will then become the root switch.

Bridge Priority determines the root bridge, which in turn determines Hello Time, Max Age and Forwarding Delay.

`hello-time <1-10>` = Specifies the time interval in seconds between BPDU (Bridge Protocol Data Units) configuration message generations by the root switch.

`maximum-age <6-40>` = Specifies the maximum time (in seconds) a switch can wait without receiving a BPDU before attempting to reconfigure. All switch ports (except for designated ports) should receive BPDUs at regular intervals. Any port that ages out STP information (provided in the last BPDU) becomes the designated port for the attached LAN. If it is a root port, a new root port is selected from among the switch ports attached to the network.

`forward-delay <4-30>` = Specifies the maximum time (in seconds) a switch will wait before changing states. This delay is required because every switch must receive information about topology changes before it starts to forward frames. In addition, each port needs time to listen for conflicting information that would make it return to a blocking state; otherwise, temporary data loops might result.

<code><port-list> path-cost <1-65535></code>	=	Enables STP on the specified ports.
		Specifies the cost of transmitting a frame on to a LAN through that port. It is assigned according to the speed of the bridge.
<code><port-list> priority <0-255></code>	=	Specifies the priority for each port.
		Priority decides which port should be disabled when more than one port forms a loop in a switch. Ports with a higher priority numeric value are disabled first.

An example using `spanning-tree` command is shown next.

- Enable STP on the switch.
- Set the bridge priority of the switch to 0.
- Set the Hello Time to 4, Maximum Age to 20 and Forward Delay to 15 on the switch.
- Enable STP on port 8 with a path cost of 150.
- Set the priority for port 8 to 20.

```
sysname(config)# spanning-tree priority 0
sysname(config)# spanning-tree hello-time 4 maximum-age 20 forward-delay 15
sysname(config)# spanning-tree 8 path-cost 150
sysname(config)# spanning-tree 8 priority 20
```

32.4 no Command Examples

These are the commonly used command examples that belong to the `no` group of commands. The `no` group commands are commands which are preceded by keyword `no`. This command negates the intended action of the command. In most cases the `no` command disables, resets or clears settings. There are cases, however, where the `no` command can activate features. This section shows some uses of these commands.

32.4.1 Disable Commands

Use the `no` command to disable features on the switch.

Syntax:

```
no spanning-tree
no mirror-port
```

Disables STP on the switch.

Disables port mirroring on the switch.

32.4.2 Resetting Commands

Use the `no` command to reset switch settings to their default values.

Syntax:

```
no https timeout
```

Resets the https session timeout to default.

An example is shown next. The session timeout is reset to 300 seconds.

```
sysname(config)# no https timeout
Cache timeout 300
```

32.4.3 Re-enable commands

The `no` command can also be used to re-enable features which have been disabled.

Syntax:

```
no ip route <ip> <mask> inactive
```

where

`<ip> <mask> inactive` = Re-enables an ip route with the specified IP address and subnet mask.

An example is shown next.

- Enable the IP route with the IP address of 192.168.11.1 and subnet mask of 255.255.255.0. This ip route must have already been created and made inactive prior to re-enable command being applied.

```
sysname(config)# no ip route 192.168.11.1 255.255.255.0 inactive
```

32.4.4 Other Examples of no Commands

In some cases the `no` command can disable a feature, disable an option of a feature or disable a feature on a port by port basis.

32.4.4.1 no trunk

Syntax:

```
no trunk <T1|T2>
no trunk <T1|T2> lacp
no trunk <T1|T2> interface <port-list>
```

where

<T1 T2>	=	Disables the trunk group.
<T1 T2> lacp	=	Disables LACP in the trunk group.
<T1 T2> interface <port-list>	=	Removes ports from the trunk group.

An example is shown next.

- Disable trunk one (T1).
- Disable LACP on trunk two (T2).
- Remove ports one, three, four and five from trunk two (T2).

```
sysname(config)# no trunk T1
sysname(config)# no trunk T2 lacp
sysname(config)# no trunk T2 interface 1,3-5
```

32.4.4.2 no port-access-authenticator

Syntax:

```
no port-access-authenticator
no port-access-authenticator <port-list> reauthenticate
no port-access-authenticator <port-list>
```

where

	=	Disables port authentication on the switch.
<port-list> reauthenticate	=	Disables the re-authentication mechanism on the listed port(s).
<port-list>	=	Disables authentication on the listed ports.

An example is shown next.

- Disable authentication on the switch.
- Disable re-authentication on ports one, three, four and five.
- Disable authentication on ports one, six and seven.

Figure 108 no port-access-authenticator Command Example

```

sysname(config)# no port-access-authenticator
sysname(config)# no port-access-authenticator 1,3-5 reauthenticate
sysname(config)# no port-access-authenticator 1,6-7

```

32.4.4.3 no ssh

Syntax:

```

no ssh key <rsa1|rsa|dsa>
no ssh known-hosts <host-ip>
no ssh known-hosts <host-ip> [1024|ssh-rsa|ssh-dsa]

```

where

key <rsa1 rsa dsa>	=	Disables the secure shell server encryption key. Your switch supports SSH versions 1 and 2 using RSA and DSA authentication.
known-hosts <host-ip>	=	Removes a specific remote host from the list of all known hosts.
known-hosts <host-ip> [1024 ssh-rsa ssh-dsa]	=	Removes remote known hosts with a specified public key type (1024-bit RSA1, RSA or DSA).

An example is shown next.

- Disable the secure shell RSA1 encryption key.
- Remove the remote host with IP address 172.165.1.8 from the list of known hosts.
- Remove the remote host with IP address 172.165.1.9 and with an SSH-RSA encryption key from the list of known hosts.

```

sysname(config)# no ssh key rsa1
sysname(config)# no ssh known-hosts 172.165.1.8
sysname(config)# no ssh known-hosts 172.165.1.9 ssh-rsa

```

32.5 Queuing Method Commands

You can use the queuing method commands to configure queuing for outgoing traffic on the switch. You can only select one queuing method for the switch.

Syntax:

```

spq

wrr
wrr <wt1> <wt2> <wt3> <wt4>

```

where

<code>spq</code>	=	Sets the queuing method to SPQ (Strictly Priority Queuing).
<code>wrr</code>	=	Sets the queuing method to WRR (Weighted Round Robin).
<code>wrr <wt1> <wt2> <wt3> <wt4></code>	=	Sets the weights for the queues 1 to 4. Weight can be from 1-15.

An example is shown next.

- Set the queuing method to WRR.
- Set the weights for queues 1 to 4 with the values 10, 8, 6 and 4 respectively.

```
sysname(config)# wrr  
sysname(config)# wrr 10 8 6 4
```

32.6 Static Route Commands

You can create and configure static routes on the switch by using the `ip route` command.

Syntax:

```
ip route <ip> <mask> <next-hop-ip>  
ip route <ip> <mask> <next-hop-ip> [metric <metric>] [name <name>]  
-> [inactive]
```

where

<code><ip></code>	=	Specifies the network IP address of the final destination.
<code><mask></code>	=	Specifies the subnet mask of this destination.
<code><next-hop-ip></code>	=	Specifies the IP address of the gateway. The gateway is an immediate neighbor of your switch that will forward the packet to the destination. The gateway must be a router on the same segment as your switch.
<code>[metric <metric>]</code>	=	The metric represents the “cost” of transmission for routing purposes. IP routing uses hop count as the measurement of cost, with a minimum of 1 for directly connected networks. Enter a number that approximates the cost for this link. The number need not be precise, but it must be between 1 and 15. In practice, 2 or 3 is usually a good number.
<code>[name <name>]</code>	=	Specifies a descriptive name (up to 32 printable ASCII characters) for identification purposes.
<code>[inactive]</code>	=	Deactivates a static route

An example is shown next.

- Create a static route with the destination IP address of 172.21.1.104, subnet mask of 255.255.0.0 and the gateway IP address of 192.168.1.2.
- Assigns a metric value of 2 to the static route and the name “route1” to the static route.

```
sysname(config)# ip route 172.21.1.104 255.255.0.0 192.168.1.2
sysname(config)# ip route 172.21.1.104 255.255.0.0 192.168.1.2 metric 2 name
-> route1
```

32.7 Enabling MAC Filtering

You can create a filter to drop packets based on the MAC address of the source or the destination.

Syntax:

```
mac-filter name <name> mac <mac-addr> vlan <vlan-id> drop <src/dst/both>
```

where

name <name>	=	Names the filtering rule.
mac <mac-addr>	=	Specifies the MAC address you want to filter.
vlan <vlan-id>	=	Specifies which VLAN this rule applies to.
drop <src/dst/both>	=	Selects the behavior of the rule.

- src - drop packets coming from the specified MAC address
- dst- drop packets going to the specified MAC address
- both - drop packets coming from or going to the specified MAC address

An example is shown next.

- Create a filtering rule called “filter1” and drop packets coming from and going to MAC address 00:12:00:12:00:12 on VLAN 1.

```
sysname(config)# mac-filter name filter 1 mac 00:12:00:12:00:12 vlan 1 drop
both
```

32.8 Enabling Trunking

To create and enable a trunk, enter `trunk` followed by the ports which you want to group and press [ENTER].

Syntax:

```
trunk <T1|T2>
trunk <T1|T2> interface <port-list>
trunk <T1|T2> lacp
```

where

<code><T1 T2></code>	=	Enables the trunk.
<code><T1 T2> interface <port-list></code>	=	Places ports in the trunk.
<code><T1 T2> lacp</code>	=	Enables LACP in the trunk.

An example is shown next.

- Create trunk 1 on the switch.
- Place ports 5-8 in trunk 1.
- Enable dynamic link aggregation (LACP) on trunk 1.

```
sysname(config)# trunk t1
sysname(config)# trunk t1 interface 5-8
sysname(config)# trunk t1 lacp
```

32.9 Enabling Port Authentication

To enable a port authentication, you need to specify your RADIUS server details and select the ports which require external authentication. You can set up multiple RADIUS servers and specify how the switch will process authentication requests.

32.9.1 RADIUS Server Settings

Configuring multiple RADIUS servers is only available via the command interpreter mode. Use the `radius-server` command to set up your RADIUS server settings.

Syntax:

```
radius-server host <index> <ip>
radius-server host <index> <ip> [acct-port <socket-number>] [key <key-string>]
radius-server timeout <1-1000>
radius-server mode <priority|round-robin>
```

where

<code>radius-server host <index> <ip></code>	=	Specifies the IP address of the RADIUS server.
<code>[acct-port <socket-number>]</code>	=	Changes the UDP port of the RADIUS server from the default (1812).
<code>[key <key-string>]</code>	=	Specifies a password (up to 32 alphanumeric characters) as the key to be shared between the RADIUS server and the switch.
<code>radius-server timeout <1-1000></code>	=	Specifies the timeout period (in seconds) the switch will wait for a response from a RADIUS server. If 2 RADIUS servers are configured, this is the total time the switch will wait for a response from either server.
<code>mode <priority round-robin></code>	=	Specifies the way the switch will process requests from the clients to the RADIUS server. (Only applicable with multiple RADIUS servers configured.)

`priority` - When a client sends an authentication request through the switch to the RADIUS server. The switch will forward the request to the RADIUS server. If no response within half the timeout period, it will forward the request to the second RADIUS server.

`round-robin` - When a client sends an authentication request through the switch to the RADIUS server. The switch will forward the request to the first RADIUS server. If there is no response within the timeout period, the request times out. The client sends an authentication request again and the switch forwards the request to the second RADIUS server.

See [Section 32.9.2 on page 229](#) for an example.

32.9.2 Port Authentication Settings

Use the `port-access-authenticator` command to configure port security on the switch.

Syntax:

```
port-access-authenticator
port-access-authenticator <port-list>
port-access-authenticator <port-list> reauthenticate
port-access-authenticator <port-list> reauth-period <reauth-period>
```

where

<code>port-access-authenticator</code>	=	Enables port authentication on the switch.
<code>port-access-authenticator <port-list></code>	=	Specifies which ports require authentication.
<code>reauthenticate</code>	=	Enables reauthentication on the port.
<code>reauth-period <reauth-period></code>	=	Specifies how often a client has to re-enter his or her username and password to stay connected to the port.

An example is shown next.

- Specify RADIUS server 1 with IP address 10.10.10.1, port 1890 and the string `secretKey` as the password. See [Section 32.9.1 on page 228](#) for more information on RADIUS server commands.
- Specify the timeout period of 30 seconds that the switch will wait for a response from the RADIUS server.
- Enable port authentication on ports 4 to 8.
- Activate reauthentication on the ports.
- Specify 1800 seconds as the interval for client reauthentication.

```
sysname(config)# radius-server host 1 10.10.10.1 acct-port 1890 key
secretKey
sysname(config)# radius-server timeout 30
sysname(config)# port-access-authenticator
sysname(config)# port-access-authenticator 4-8
sysname(config)# port-access-authenticator 4-8 reauthenticate
sysname(config)# port-access-authenticator 8 reauth-period 1800
```

CHAPTER 33

Interface Commands

These are some commonly used configuration commands that belong to the `interface` group of commands.

33.1 Overview

The interface commands allow you to configure the switch on a port by port basis.

33.2 Interface Command Examples

This section provides examples of some frequently used interface commands.

33.2.1 interface port-channel

Use this command to enable the specified ports for configuration. Indicate multiple, non-sequential ports separated by a comma. Use a dash to specify a port range.

Syntax:

```
interface port-channel <port-list>
```

An example is shown next.

- Enter the configuration mode.
- Enable ports 1, 3, 4 and 5 for configuration.
- Begin configuring for those ports.

```
sysname# config
sysname(config)# interface port-channel 1,3-5
sysname(config-interface)#
```

33.2.2 broadcast/multicast storm control

Syntax:

```
bmstorm-limit
bmstorm-limit <Kbps>
```

where

<code>bmstorm-limit</code>	=	Enables broadcast/multicast storm control limit on the switch.
<code><Kbps></code>	=	Limits how much broadcast/multicast traffic the interface receives in kilobytes per second.

An example is shown next.

- Enable port one for configuration.
- Enable broadcast control.
- Set how many broadband packets the interface receives per second.

```
sysname(config)# interface port-channel 1
sysname(config-interface)# bmstorm-limit
sysname(config-interface)# bmstorm-limit 64
```

33.2.3 bandwidth-limit

The `bandwidth-limit` command enables bandwidth control on the switch.

Syntax:

```
bandwidth-limit
bandwidth-limit ingress
bandwidth-limit ingress <Kbps>
bandwidth-limit egress
bandwidth-limit egress <Kbps>
```

where

<code>ingress</code>	=	Activates bandwidth limits for incoming traffic (<code>ingress</code>) on the port.
<code>ingress <Kbps></code>	=	Sets the maximum bandwidth allowed for incoming traffic (<code>ingress</code>) on the port.
<code>egress</code>	=	Activates bandwidth limits for outgoing traffic (<code>egress</code>) on the port.
<code>egress <Kbps></code>	=	Sets the maximum bandwidth allowed for outgoing traffic (<code>egress</code>) on the port.

An example is shown next.

- Enable port one for configuration.
- Enable bandwidth limits for outgoing traffic on port 1.

- Set the outgoing traffic bandwidth limit to 5000Kbps..

```
sysname(config)# interface port-channel 1
sysname(config-interface)# bandwidth-limit egress
sysname(config-interface)# bandwidth-limit egress 5000
```

33.2.4 mirror

The `mirror` command enables port mirroring on the interface.

Syntax:

```
mirror
mirror dir <ingress|egress|both>
```

where

`dir`
`<ingress|egress|both>` = Enables port mirroring for incoming, outgoing or both incoming and outgoing traffic.

Port mirroring copies traffic from one or all ports to another or all ports for external analysis.

An example is shown next.

- Enable port mirroring.
- Enable the monitor port 3.
- Enable ports 1, 4, 5 and 6 for configuration.
- Enable port mirroring on the ports.
- Enable port mirroring for outgoing traffic. Traffic is copied from ports 1, 4, 5 and 6 to port three in order to examine it in more detail without interfering with the traffic flow on the original ports.

```
sysname(config)# mirror-port
sysname(config)# mirror-port 3
sysname(config)# interface port-channel 1,4-6
sysname(config-interface)# mirror
sysname(config-interface)# mirror dir egress
```

33.2.5 gvrp

Syntax:

```
gvrp
```

GVRP (GARP VLAN Registration Protocol) is a registration protocol that defines a way for switches to register necessary VLAN members on ports across the network. Enable this function to permit VLAN groups beyond the local switch.

An example is shown next.

- Enable the IEEE 802.1Q tagged VLAN command to configure tagged VLAN for the switch.
- Enable ports one, three, four and five for configuration.
- Enable GVRP on the interface.

```
sysname(config)# vlan1q gvrp
sysname(config)# interface port-channel 1,3-5
sysname(config-interface)# gvrp
```

33.2.6 frame-type

Syntax:

```
frame-type <all|tagged>
```

where

<all|tagged> = Choose to accept both tagged and untagged incoming frames, just tagged incoming frames or just untagged incoming frames on a port.

An example is shown next.

- Enable ports one, three, four and five for configuration.
- Enable tagged frame-types on the interface.

```
sysname(config)# interface port-channel 1,3-5
sysname(config-interface)# frame-type tagged
```

33.2.7 egress set

Syntax:

```
egress set <port-list>
```

where

<port-list> = Sets the outgoing traffic port list for a port-based VLAN.

An example is shown next.

- Enable port-based VLAN tagging on the switch.
- Enable ports one, three, four and five for configuration.
- Set the outgoing traffic ports as the CPU (0), seven (7) and eight (8).

```
sysname(config)# vlan-type port-based
sysname(config)# interface port-channel 1,3-5
sysname(config-interface)# egress set 0,7,9
```

33.2.8 qos priority

Syntax:

```
qos priority <0 .. 7>
```

where

<0 .. 7> = Sets the quality of service priority for a port.

An example is shown next.

- Enable ports one, three, four and five for configuration.
- Set the IEEE 802.1p quality of service priority as four (4).

```
sysname(config)# interface port-channel 1,3-5
sysname(config-interface)# qos priority 4
```

33.2.9 name

Syntax:

```
name <port-name-string>
```

where

<port-name-string> = Sets a name for your port interface(s).

An example is shown next.

- Enable ports one for configuration.
- Sets a name for the port.

```
sysname(config)# interface port-channel 1
sysname(config-interface)# name Test
```

33.2.10 speed-duplex

Syntax:

```
speed-duplex <auto|10-half|10-full|100-half|100-full|1000-full>
```

where

<pre><auto 10-half 10- full 100-half 100- full 1000-full></pre>	<p>= Sets the duplex mode (half or full) and speed (10, 100 or 1000 Mbps) of the connection on the port. Selecting auto (auto-negotiation) makes one port able to negotiate with a peer automatically to obtain the connection speed and duplex mode that both ends support.</p>
---	--

An example is shown next.

- Enable ports one, three, four and five for configuration.
- Set the speed to 100 Mbps in half duplex mode.

```
sysname(config)# interface port-channel 1,3-5  
sysname(config-interface)# speed-duplex 100-half
```

33.2.11 test

You can perform an interface loopback test on specified ports. The test returns `Passed!` or `Failed!`

An example is shown next.

- Select ports 3-6 for internal loopback test.
- Execute the test command.
- View the results.

```
sysname(config)# interface port-channel 3-6  
sysname(config-interface)# test 3-6  
Testing internal loopback on port 3 :Passed!  
  Ethernet Port 3 Test ok.  
Testing internal loopback on port 4 :Passed!  
  Ethernet Port 4 Test ok.  
Testing internal loopback on port 5 :Passed!  
  Ethernet Port 5 Test ok.  
Testing internal loopback on port 6 :Passed!  
  Ethernet Port 6 Test ok.
```

33.3 Interface no Command Examples

Similar to the no commands in the Enable and Config modes, the no commands for the Interface sub mode also disable certain features. In this mode, however, this takes place on a port by port basis.

33.3.1 no bandwidth-limit

You can disable bandwidth limit on port 1 simply by placing the no command in front of the bandwidth-limit command.

Syntax:

```
no bandwidth-limit ingress
no bandwidth-limit egress
```

An example is shown next:

- Disable bandwidth limits for incoming traffic on port 1.

```
sysname(config)# interface port-channel 1
sysname(config-interface)# no bandwidth-limit ingress
```

CHAPTER 34

IEEE 802.1Q Tagged VLAN Commands

This chapter describes the IEEE 802.1Q Tagged VLAN and associated commands.

34.1 Configuring Tagged VLAN

The following procedure shows you how to configure tagged VLAN.

- 1 Use the IEEE 802.1Q tagged VLAN commands to configure tagged VLAN for the switch.
 - Use the `vlan <vlan-id>` command to configure or create a VLAN on the switch. The switch automatically enters the `config-vlan` mode. Use the `inactive` command to deactivate the VLAN(s).
 - Use the `interface port-channel <port-list>` command to enter the config-interface mode to set the VLAN settings on a port, then use the `pvid <vlan-id>` command to set the VLAN ID you created for the port-list to that specific port in the PVID table.
 - Use the `exit` command when you are finished configuring the VLAN.

```
sysname (config)# vlan 2000
sysname (config-vlan)# name up1
sysname (config-vlan)# fixed 4-6
sysname (config-vlan)# no untagged 4-6
sysname (config-vlan)# exit
sysname (config)# interface port-channel 4-6
sysname (config-interface)# pvid 2000
sysname (config-interface)# exit
```

- 2 Configure your management VLAN.

- Use the `vlan <vlan-id>` command to create a VLAN (VID 3 in this example) for managing the switch, and the switch will activate the new management VLAN.
- Use the `inactive` command to disable the new management VLAN.

```
sysname (config)# vlan 3
sysname (config-vlan)# inactive
```

34.2 Global VLAN1Q Tagged VLAN Configuration Commands

This section shows you how to configure and monitor the IEEE 802.1Q Tagged VLAN.

34.2.1 GARP Status

Syntax:

```
show garp
```

This command shows the switch's GARP timer settings, including the join, leave and leave all timers.

An example is shown next.

```
sysname# show garp
GARP Timer
-----
Join Timer           = 200
Leave Timer           = 600
Leave All Timer       = 10000
sysname#
```

34.2.2 GARP Timer

Syntax:

```
garp join <msec> leave <msec> leaveall <msec>
```

where

- `join <msec>` = This sets the duration of the Join Period timer for GVRP in milliseconds. Each port has a Join Period timer. The allowed Join Time range is between 100 and 32767 milliseconds; the default is 200 milliseconds.
- `leave <msec>` = This sets the duration of the Leave Period timer for GVRP in milliseconds. Each port has a single Leave Period timer. Leave Time must be two times larger than Join Timer; the default is 600 milliseconds.
- `leaveall <msec>` = This sets the duration of the Leave All Period timer for GVRP in milliseconds. Each port has a single Leave All Period timer. Leave All Timer must be larger than Leave Timer; the default is 10000 milliseconds.

This command sets the switch's GARP timer settings, including the join, leave and leave all timers.

Switches join VLANs by making a declaration. A declaration is made by issuing a Join message using GARP. Declarations are withdrawn by issuing a Leave message. A Leave All message terminates all registrations. GARP timers set declaration timeout values.

The following example sets the Join Timer to 300 milliseconds, the Leave Timer to 800 milliseconds and the Leave All Timer to 11000 milliseconds.

```
sysname(config)# garp join 300 leave 800 leaveall 11000
```

34.2.3 GVRP Timer

Syntax:

```
show vlan1q gvrp
```

This command shows the switch's GVRP settings.

An example is shown next.

```
sysname# show vlan1q gvrp
GVRP Support
-----
gvrpEnable = YES
sysname#
```

34.2.4 Enable GVRP

Syntax:

```
vlan1q gvrp
```

This command turns on GVRP in order to propagate VLAN information beyond the switch.

34.2.5 Disable GVRP

Syntax:

```
no vlan1q gvrp
```

This command turns off GVRP so that the switch does not propagate VLAN information to other switches.

34.3 Port VLAN Commands

You must configure the switch port VLAN settings in config-interface mode.

34.3.1 Set Port VID

Syntax:

```
pvid <VID>
```

where

<VID> = Specifies the VLAN number between 1 and 4094.

This command sets the default VLAN ID on the port(s).

The following example sets the default VID to 200 on ports 1 to 5.

```
sysname(config)# interface port-channel 1-5
sysname(config-interface)# pvid 200
```

34.3.2 Set Acceptable Frame Type

Syntax:

```
frame-type <all|tagged>
```

where

<all|tagged> = Specifies all Ethernet frames (tagged and untagged), only tagged Ethernet frames or only untagged Ethernet frames.

This command sets the specified port to accept all Ethernet frames or only those with an IEEE 802.1Q VLAN tag.

The following example sets ports 1 to 5 to accept only tagged frames.

```
sysname(config)# interface port-channel 1-5
sysname(config-interface)# frame-type tagged
```

34.3.3 Enable or Disable Port GVRP

Use the `gvrp` command to enable GVRP on the port(s). Use the `no gvrp` command to disable GVRP.

The following example turns off GVRP for ports 1 to 5.

```
sysname(config)# interface port-channel 1-5
sysname(config-interface)# no gvrp
```

34.3.4 Modify Static VLAN

Use the following commands in the config-vlan mode to configure the static VLAN table.

Syntax:

```
vlan <vlan-id>
fixed <port-list>
forbidden <port-list>
name <name-str>
normal <port-list>
untagged <port-list>
no fixed <port-list>
no forbidden <port-list>
no untagged <port-list>
```

where

<vlan-id> = The VLAN ID [1 – 4094].
 <name-str> = A name to identify the SVLAN entry.
 <port-list> = This is the switch port list.

- Enter `fixed` to register the <port-list> to the static VLAN table with <vlan-id>.
- Enter `normal` to confirm registration of the <port-list> to the static VLAN table with <vlan-id>.
- Enter `forbidden` to block a <port-list> from joining the static VLAN table with <vlan-id>.
- Enter `no fixed` or `no forbidden` to change <port-list> to normal status.
- Enter `untagged` to send outgoing frames without a tag.
- Enter `no untagged` to tag outgoing frames.

34.3.4.1 Modify a Static VLAN Table Example

The following example configures ports 1 to 5 as fixed and untagged ports in VLAN 2000.

```
sysname(config)# vlan 2000
sysname(config-vlan)# fixed 1-5
sysname(config-vlan)# untagged 1-5
```

34.3.4.2 Forwarding Process Example

34.3.4.2.1 Tagged Frames

- 1 First the switch checks the VLAN ID (VID) of tagged frames or assigns temporary VIDs to untagged frames.
- 2 The switch then checks the VID in a frame's tag against the SVLAN table.

- 3 The switch notes what the SVLAN table says (that is, the SVLAN tells the switch whether or not to forward a frame and if the forwarded frames should have tags).
- 4 Then the switch applies the port filter to finish the forwarding decision. This means that frames may be dropped even if the SVLAN says to forward them. Frames might also be dropped if they are sent to a CPE (customer premises equipment) DSL device that does not accept tagged frames.

34.3.4.2.2 Untagged Frames

- 1 An untagged frame comes in from the LAN.
- 2 The switch checks the PVID table and assigns a temporary VID of 1.
- 3 The switch ignores the port from which the frame came, because the switch does not send a frame to the port from which it came. The switch also does not forward frames to “forbidden” ports.
- 4 If after looking at the SVLAN, the switch does not have any ports to which it will send the frame, it won't check the port filter.

34.3.5 Delete VLAN ID

Syntax:

```
no vlan <vlan-id>
```

where

<vlan-id> = The VLAN ID [1 – 4094].

This command deletes the specified VLAN ID entry from the static VLAN table. The following example deletes entry 2 in the static VLAN table.

```
sysname(config)# no vlan 2
```

34.4 Enable VLAN

Syntax:

```
vlan <vlan-id>
```

This command enables the specified VLAN ID in the SVLAN (Static VLAN) table.

34.5 Disable VLAN

Syntax:

```
vlan <vlan-id> inactive
```

This command disables the specified VLAN ID in the SVLAN (Static VLAN) table.

34.6 Show VLAN Setting

Syntax:

```
show vlan
```

This command shows the IEEE 802.1Q Tagged SVLAN (Static VLAN) table.

An example is shown next.

- VID is the VLAN identification number.
- Status shows whether the VLAN is static or active.
- Elap-Time is the time since the VLAN was created on the switch.
- The TagCtl section of the last column shows which ports are tagged and which are untagged.

```
sysname# show vlan
The Number of VLAN: 3
Idx. VID  Status  Elap-Time  TagCtl
-----
1   1     Static   0:12:13   Untagged :1-5
                        Tagged   :
1  100    Static   0:00:17   Untagged :
                        Tagged   :1-4
1  200    Static   0:00:07   Untagged :1-2
                        Tagged   :3-8
```

CHAPTER 35

Multicast VLAN Registration Commands

This chapter shows you how to use Multicast VLAN Registration (mvr) commands.

35.1 Overview

Use the mvr commands in the configuration mode to create and configure multicast VLANs.

Note: If you want to enable IGMP snooping see [Section 32.1 on page 219](#).

35.2 Create Multicast VLAN

Use the following commands in the config-mvr mode to configure a multicast VLAN group.

Syntax:

```
mvr <vlan-id>
mvr <vlan-id> source-port <port-list>
mvr <vlan-id> receiver-port <port-list>
mvr <vlan-id> inactive
mvr <vlan-id> mode <dynamic|compatible>
mvr <vlan-id> name <name-str>
mvr <vlan-id> tagged <port-list>
mvr <vlan-id> group <name-str> start-address <ip> end-address <ip>
mvr <vlan-id> exit
```

where

<vlan-id>	=	The VLAN ID [1 – 4094].
source-port <port-list>	=	Specifies the MVR source ports which send and receive multicast traffic.
receiver-port <port-list>	=	Specifies the MVR receiving ports which only receive multicast traffic.
name <name-str>	=	A name to identify the multicast VLAN group.
mode <dynamic compatible>	=	Specifies dynamic (sends IGMP reports to all source ports in the multicast VLAN) or compatible (does not send IGMP reports).

`group name` = A name to identify the MVR IP multicast group.
`<name-str>`

`start-address` = Specifies the starting IP multicast address of the multicast group in dotted decimal notation.
`<ip>`

`end-address <ip>` = Specifies the ending IP multicast address of the multicast group in dotted decimal notation. Enter the same IP address as the start-address if you want to configure only one IP address for the multicast group.

- Enter MVR mode. Create a multicast VLAN with the name `multivlan` and the VLAN ID of 3.
- Specify source ports 2, 3, 5 and receiver ports 6-8.
- Specify dynamic mode for the multicast group.
- Configure MVR multicast group addresses by the name of `ipgroup`.
- Exit MVR mode.

See the following example.

```
sysname(config)# mvr 3
sysname(config-mvr)# source-port 2,3,5
sysname(config-mvr)# receiver-port 6-8
sysname(config-mvr)# mode dynamic
sysname(config-mvr)# group ipgroup start-address 224.0.0.1 end-address
224.0.0.255
sysname(config-mvr)# name multivlan
sysname(config-mvr)# exit
```

CHAPTER 36

Troubleshooting

This chapter covers potential problems and possible remedies.

36.1 Problems Starting Up the Switch

Table 78 Troubleshooting the Start-Up of Your Switch

PROBLEM	CORRECTIVE ACTION
None of the LEDs turn on when you turn on the switch.	Check the power connection and make sure the power source is turned on.
	If the error persists, you may have a hardware problem. In this case, you should contact your vendor.

36.2 Problems Accessing the Switch

Table 79 Troubleshooting Accessing the Switch

PROBLEM	CORRECTIVE ACTION
I cannot access the switch using Telnet.	Make sure the ports are properly connected. You may have exceeded the maximum number of concurrent Telnet sessions. Close other Telnet session(s) or try connecting again later. Check that you have enabled Telnet service access. If you have configured a secured client IP address, your computer's IP address must match it. Refer to the chapter on access control for details.

Table 79 Troubleshooting Accessing the Switch

PROBLEM	CORRECTIVE ACTION
I cannot access the web configurator.	<p>The administrator username is “admin”. The default administrator password is “1234”. The username and password are case-sensitive. Make sure that you enter the correct password and username using the proper casing. If you have changed the password and have now forgotten it, you will need to upload the default configuration file. This restores all of the factory defaults including the password.</p> <p>Check that you have enabled web service access. If you have configured a secured client IP address, your computer's IP address must match it. Refer to the chapter on access control for details.</p> <p>Your computer's and the switch's IP addresses must be on the same subnet.</p> <p>See the following section to check that pop-up windows, JavaScripts and Java permissions are allowed.</p>
I cannot access the web configurator.	<p>You may also need to clear your Internet browser's cache.</p> <p>In Internet Explorer, click Tools and then Internet Options to open the Internet Options screen.</p> <p>In the General tab, click Delete Files. In the pop-up window, select the Delete all offline content check box and click OK. Click OK in the Internet Options screen to close it.</p> <p>If you disconnect your computer from one device and connect it to another device that has the same IP address, your computer's ARP (Address Resolution Protocol) table may contain an entry that maps the management IP address to the previous device's MAC address).</p> <p>In Windows, use arp -d at the command prompt to delete all entries in your computer's ARP table.</p>

36.2.1 Pop-up Windows, JavaScripts and Java Permissions

In order to use the web configurator you need to allow:

- Web browser pop-up windows from your device.
- JavaScripts (enabled by default).
- Java permissions (enabled by default).

Note: Internet Explorer 6 screens are used here. Screens for other Internet Explorer versions may vary.

36.2.1.1 Internet Explorer Pop-up Blockers

You may have to disable pop-up blocking to log into your device.

Either disable pop-up blocking (enabled by default in Windows XP SP (Service Pack) 2) or allow pop-up blocking and create an exception for your device's IP address.

36.2.1.1.1 Disable pop-up Blockers

- 1** In Internet Explorer, select **Tools, Pop-up Blocker** and then select **Turn Off Pop-up Blocker**.

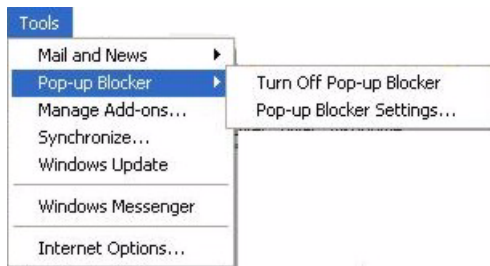
Figure 109 Pop-up Blocker

You can also check if pop-up blocking is disabled in the **Pop-up Blocker** section in the **Privacy** tab.

- 1 In Internet Explorer, select **Tools, Internet Options, Privacy**.
- 2 Clear the **Block pop-ups** check box in the **Pop-up Blocker** section of the screen. This disables any web pop-up blockers you may have enabled.

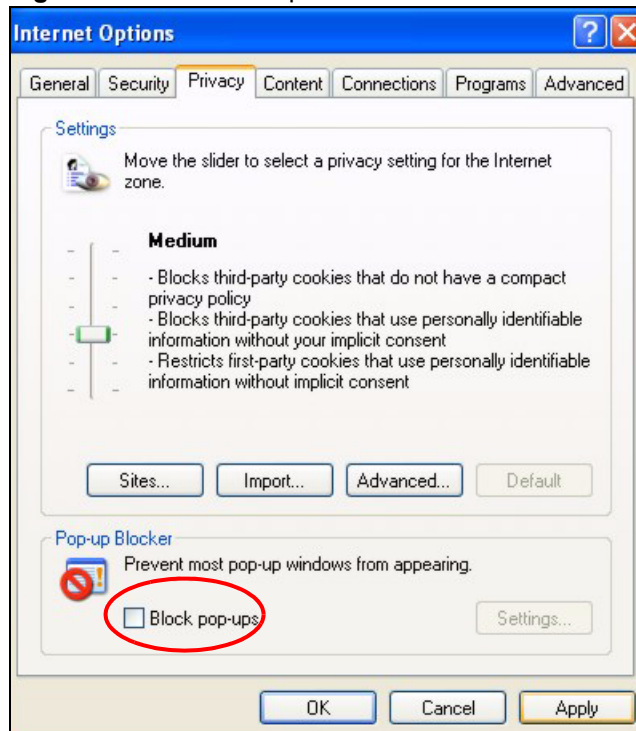
Figure 110 Internet Options

- 3 Click **Apply** to save this setting.

36.2.1.1.2 Enable pop-up Blockers with Exceptions

Alternatively, if you only want to allow pop-up windows from your device, see the following steps.

- 1 In Internet Explorer, select **Tools, Internet Options** and then the **Privacy** tab.
- 2 Select **Settings...** to open the **Pop-up Blocker Settings** screen.

Figure 111 Internet Options

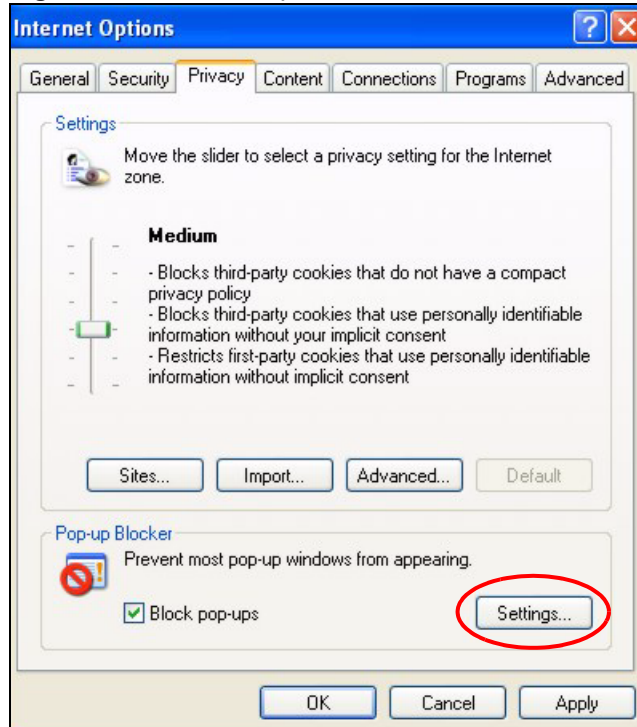

- 3 Type the IP address of your device (the web page that you do not want to have blocked) with the prefix “http://”. For example, http://192.168.1.1.
- 4 Click **Add** to move the IP address to the list of **Allowed sites**.

Figure 112 Pop-up Blocker Settings

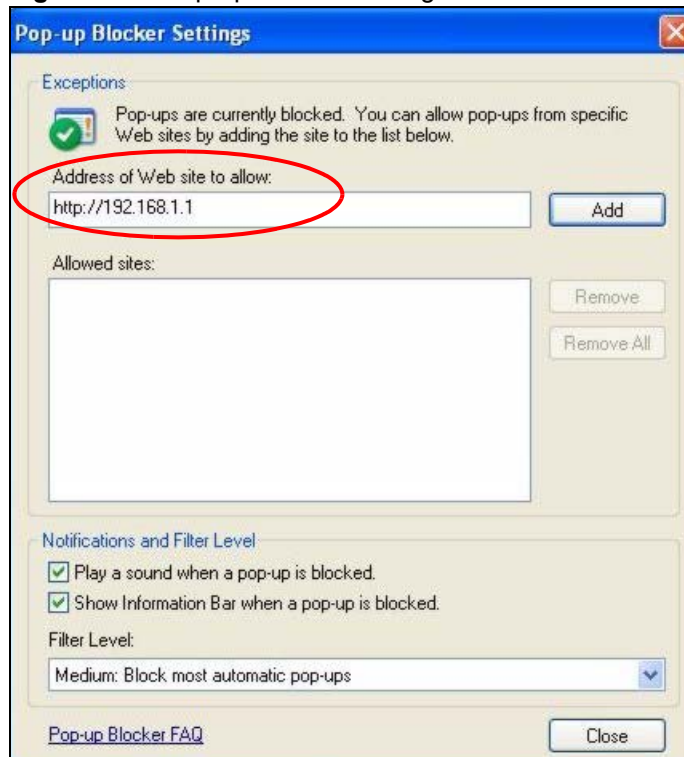

5 Click **Close** to return to the **Privacy** screen.

6 Click **Apply** to save this setting.

36.2.1.2 JavaScripts

If pages of the web configurator do not display properly in Internet Explorer, check that JavaScripts are allowed.

1 In Internet Explorer, click **Tools, Internet Options** and then the **Security** tab.

Figure 113 Internet Options

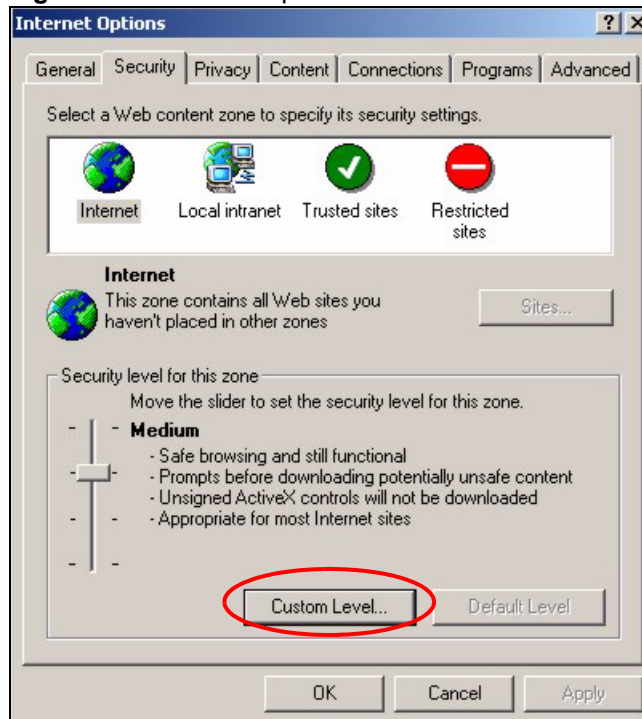

2 Click the **Custom Level...** button.

3 Scroll down to **Scripting**.

4 Under **Active scripting** make sure that **Enable** is selected (the default).

5 Under **Scripting of Java applets** make sure that **Enable** is selected (the default).

6 Click **OK** to close the window.

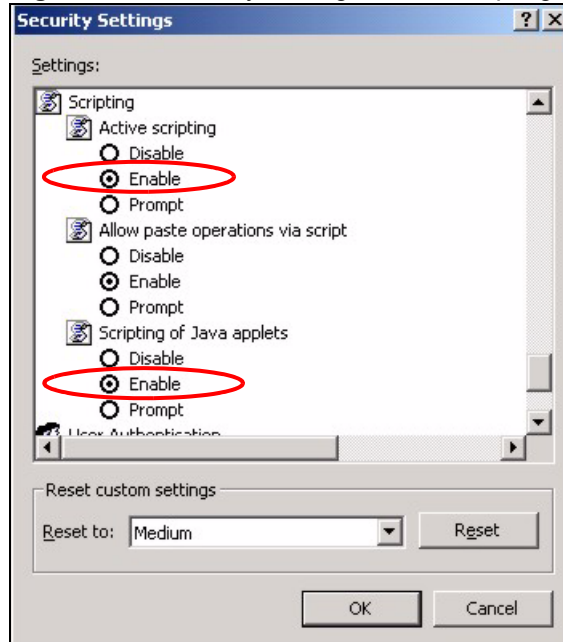
Figure 114 Security Settings - Java Scripting

36.2.1.3 Java Permissions

- 1 From Internet Explorer, click **Tools, Internet Options** and then the **Security** tab.
- 2 Click the **Custom Level...** button.
- 3 Scroll down to **Microsoft VM**.
- 4 Under **Java permissions** make sure that a safety level is selected.
- 5 Click **OK** to close the window.

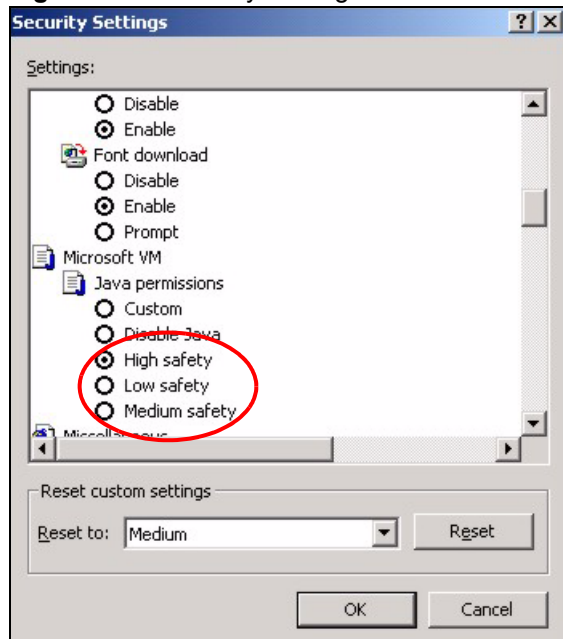
Figure 115 Security Settings - Java

36.2.1.3.1 JAVA (Sun)

- 1 From Internet Explorer, click **Tools, Internet Options** and then the **Advanced** tab.
- 2 make sure that **Use Java 2 for <applet>** under **Java (Sun)** is selected.
- 3 Click **OK** to close the window.

Figure 116 Java (Sun)

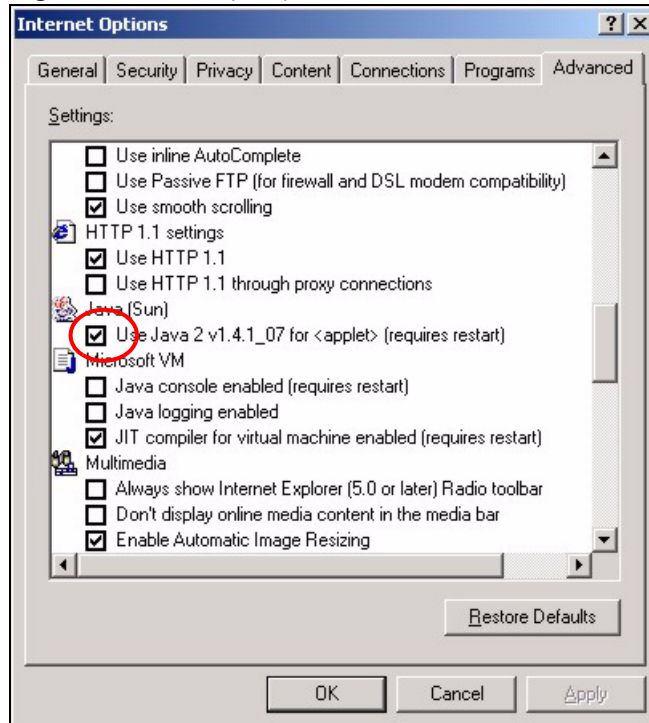

36.3 Problems with the Password

Table 80 Troubleshooting the Password

PROBLEM	CORRECTIVE ACTION
Cannot access the switch.	The password field is case sensitive. Make sure that you enter the correct password using the proper casing.
	The administrator username is "admin". The default administrator password is "1234". The username and password are case-sensitive. Make sure that you enter the correct password and username using the proper casing. If you have changed the password and have now forgotten it, you will need to upload the default configuration file. This restores all of the factory defaults including the password.

APPENDIX A

Product Specifications

These are the switch product specifications.

Table 81 General Product Specifications

Fast Ethernet Interface	<ul style="list-style-type: none"> Eight 10/100 Base-TX interfaces Auto-negotiation Auto-MDI/MDIX Compliant with IEEE 802.3/802.3u Back pressure flow control for half duplex mode Flow control for full duplex (IEEE 802.3x) RJ-45 Ethernet cable connector Rate limiting at 64Kbps steps
100 Mbps SFP Interface	ES-2108-F Only: Fast Ethernet SFP open slot for transceiver of 100BASE-FX, 100BASE-LX or 100BASE-BX
Gigabit Interface	<ul style="list-style-type: none"> One Gigabit Ethernet/mini-GBIC port (ES-2108-G and ES-2108PWR only) One mini-GBIC port and one Gigabit 100 Base-FX Fiber Optic Port (ES-2108-LC only) Compliant with 802.3z/802.3ab/802.3u Copper/fiber interface auto-selection by signal detection (Fiber first)
Bridging	<ul style="list-style-type: none"> 8K MAC addresses Static MAC address filtering (256 entries) Static MAC address forwarding (256 entries) Broadcast storm control
Switching	<ul style="list-style-type: none"> Switching fabric: 5.6 Gbps non-blocking (only 3.6 Gbps is used) Max. Frame size: 1522 bytes including tag/CRC Forwarding frame: IEEE 802.3, IEEE 802.1q, Ethernet II, PPPoE Corrupted packet forwarding prevention
STP	<ul style="list-style-type: none"> IEEE 802.1d spanning tree protocol IEEE 802.1w, rapid reconfiguration to recover network failure
QoS	<ul style="list-style-type: none"> IEEE 802.1p Four priority queues with SP/WRR by switch Supports RFC 2475 DiffServ, DSCP to IEEE 802.1p priority mapping
Security	<ul style="list-style-type: none"> IEEE 802.1x port-based authentication Static MAC Address Forwarding Static MAC Address Filtering Blocks unresolved address forwarding/Port Security
VLAN	<ul style="list-style-type: none"> Port-based VLAN setting Tag-based (IEEE 802.1Q) VLAN Number of VLAN: 4K (256 static VLANs) Supports GVRP VLAN ingress filtering
Link aggregation	<ul style="list-style-type: none"> Supports IEEE 802.3ad; static and dynamic (LACP) port trunking 2 groups, 4 ports per group maximum

Table 81 General Product Specifications (continued)

Port mirroring	Port based mirroring to a monitor port
IGMP	Supports IGMP snooping

Table 82 Management Specifications

System Management	<p>Alarm/Status surveillance LED indication for alarm and system status Performance monitoring Line speed Four RMON groups 1,2,3,9 (history, statistics, alarms, and events) Throughput monitoring CMP packet transmission Port mirroring and aggregation Spanning Tree Protocol IGMP snooping Syslog Port Cloning (copying of port attributes) Firmware upgrade and download through FTP/web/console Configuration by console/telnet/web Configuration backup and restore by FTP/web/console Login authorization and security levels (read-only and read/write) Self diagnostics FLASH memory</p>
Network Management	<p>CLI through console port and Telnet Web-based management Up to 64 management IP address in different VLAN Clustering: up to 24 switches can be managed by one IP SNMP RMON groups (history, statistics, alarms and events)</p>
MIB	<p>RFC1213 MIB II RFC1493 Bridge MIB RFC1643 Ethernet MIB RFC1757 Four groups of RMON RFC 1155 SMI RFC2674 Bridge MIB extension (for IEEE 802.1Q) ZyXEL Private MIBs for ES-2108 series</p>

Table 83 Physical and Environmental Specifications

LEDs	Per switch: PWR (Green), SYS (Green), ALM (Red) Per Ethernet port: LNK/ACT (Amber/Green) 1000Base-T RJ45: SPD (Amber/Green), LNK/ACT (Green) SFP: LNK (Green), ACT (Green) 100FX: LNK (Green), ACT (Green)
Dimensions	ES-2108/ES-2108-LC/ES-2108-G/ES-2108-F: 250mm (W) x 135mm (D) x 35mm (H) ES-2108PWR: 250mm (W) x 234.8mm (D) x 44.45mm (H) Standard 19" rack mountable
Weight	ES-2108/ES-2108-LC/ES-2108-G/ES-2108-F: 1.2 Kg ES-2108PWR: 2.4 Kg
Distance between the centers of the holes on the device's back.	129.5mm
Screw size for wall-mounting	M4*20
Temperature	Operating: 0° C ~ 45° C (32° F ~ 113° F) Storage: -10° C ~ 70° C (13° F ~ 158° F)
Humidity	10 ~ 90% (non-condensing)
Power Supply	Overload protection 100-240VAC, 50/60Hz, 0.5A Max.
Safety Standards	UL 60950-1 CSA 60950-1 EN 60950-1 IEC 60950-1
EMC	FCC Part 15 (Class A) CE EMC (Class A)

APPENDIX B

IP Addresses and Subnetting

This appendix introduces IP addresses and subnet masks.

IP addresses identify individual devices on a network. Every networking device (including computers, servers, routers, printers, etc.) needs an IP address to communicate across the network. These networking devices are also known as hosts.

Subnet masks determine the maximum number of possible hosts on a network. You can also use subnet masks to divide one network into multiple sub-networks.

Introduction to IP Addresses

One part of the IP address is the network number, and the other part is the host ID. In the same way that houses on a street share a common street name, the hosts on a network share a common network number. Similarly, as each house has its own house number, each host on the network has its own unique identifying number - the host ID. Routers use the network number to send packets to the correct network, while the host ID determines to which host on the network the packets are delivered.

Structure

An IP address is made up of four parts, written in dotted decimal notation (for example, 192.168.1.1). Each of these four parts is known as an octet. An octet is an eight-digit binary number (for example 11000000, which is 192 in decimal notation).

Therefore, each octet has a possible range of 00000000 to 11111111 in binary, or 0 to 255 in decimal.

The following figure shows an example IP address in which the first three octets (192.168.1) are the network number, and the fourth octet (16) is the host ID.

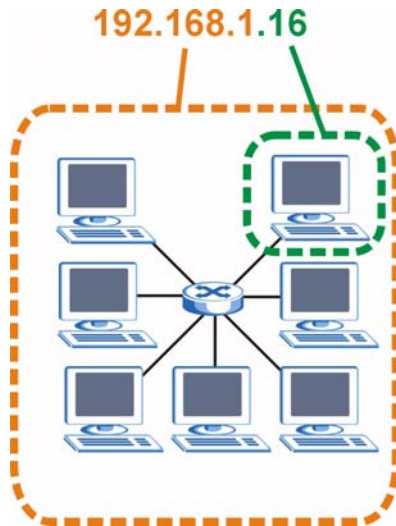
Figure 117 Network Number and Host ID

How much of the IP address is the network number and how much is the host ID varies according to the subnet mask.

Subnet Masks

A subnet mask is used to determine which bits are part of the network number, and which bits are part of the host ID (using a logical AND operation). The term “subnet” is short for “sub-network”.

A subnet mask has 32 bits. If a bit in the subnet mask is a “1” then the corresponding bit in the IP address is part of the network number. If a bit in the subnet mask is “0” then the corresponding bit in the IP address is part of the host ID.

The following example shows a subnet mask identifying the network number (in bold text) and host ID of an IP address (192.168.1.2 in decimal).

Table 84 Subnet Mask - Identifying Network Number

	1ST OCTET: (192)	2ND OCTET: (168)	3RD OCTET: (1)	4TH OCTET (2)
IP Address (Binary)	11000000	10101000	00000001	00000010
Subnet Mask (Binary)	11111111	11111111	11111111	00000000
Network Number	11000000	10101000	00000001	
Host ID				00000010

By convention, subnet masks always consist of a continuous sequence of ones beginning from the leftmost bit of the mask, followed by a continuous sequence of zeros, for a total number of 32 bits.

Subnet masks can be referred to by the size of the network number part (the bits with a “1” value). For example, an “8-bit mask” means that the first 8 bits of the mask are ones and the remaining 24 bits are zeroes.

Subnet masks are expressed in dotted decimal notation just like IP addresses. The following examples show the binary and decimal notation for 8-bit, 16-bit, 24-bit and 29-bit subnet masks.

Table 85 Subnet Masks

	BINARY				DECIMAL
	1ST OCTET	2ND OCTET	3RD OCTET	4TH OCTET	
8-bit mask	11111111	00000000	00000000	00000000	255.0.0.0
16-bit mask	11111111	11111111	00000000	00000000	255.255.0.0
24-bit mask	11111111	11111111	11111111	00000000	255.255.255.0
29-bit mask	11111111	11111111	11111111	11111000	255.255.255.248

Network Size

The size of the network number determines the maximum number of possible hosts you can have on your network. The larger the number of network number bits, the smaller the number of remaining host ID bits.

An IP address with host IDs of all zeros is the IP address of the network (192.168.1.0 with a 24-bit subnet mask, for example). An IP address with host IDs of all ones is the broadcast address for that network (192.168.1.255 with a 24-bit subnet mask, for example).

As these two IP addresses cannot be used for individual hosts, calculate the maximum number of possible hosts in a network as follows:

Table 86 Maximum Host Numbers

SUBNET MASK		HOST ID SIZE		MAXIMUM NUMBER OF HOSTS
8 bits	255.0.0.0	24 bits	$2^{24} - 2$	16777214
16 bits	255.255.0.0	16 bits	$2^{16} - 2$	65534
24 bits	255.255.255.0	8 bits	$2^8 - 2$	254
29 bits	255.255.255.248	3 bits	$2^3 - 2$	6

Notation

Since the mask is always a continuous number of ones beginning from the left, followed by a continuous number of zeros for the remainder of the 32 bit mask, you can simply specify the number of ones instead of writing the value of each octet. This is usually specified by writing a “/” followed by the number of bits in the mask after the address.

For example, 192.1.1.0 /25 is equivalent to saying 192.1.1.0 with subnet mask 255.255.255.128.

The following table shows some possible subnet masks using both notations.

Table 87 Alternative Subnet Mask Notation

SUBNET MASK	ALTERNATIVE NOTATION	LAST OCTET (BINARY)	LAST OCTET (DECIMAL)
255.255.255.0	/24	0000 0000	0
255.255.255.128	/25	1000 0000	128
255.255.255.192	/26	1100 0000	192
255.255.255.224	/27	1110 0000	224
255.255.255.240	/28	1111 0000	240
255.255.255.248	/29	1111 1000	248
255.255.255.252	/30	1111 1100	252

Subnetting

You can use subnetting to divide one network into multiple sub-networks. In the following example a network administrator creates two sub-networks to isolate a group of servers from the rest of the company network for security reasons.

In this example, the company network address is 192.168.1.0. The first three octets of the address (192.168.1) are the network number, and the remaining octet is the host ID, allowing a maximum of $2^8 - 2$ or 254 possible hosts.

The following figure shows the company network before subnetting.

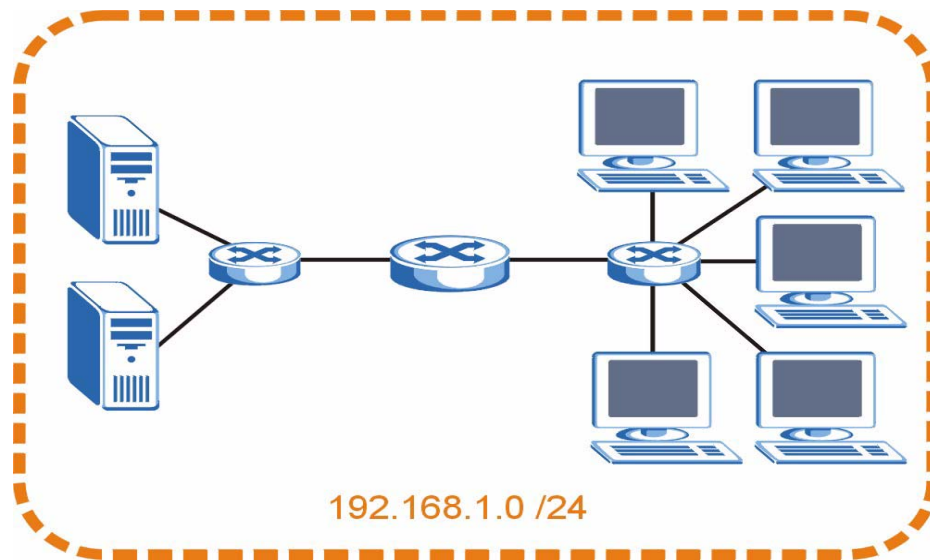
Figure 118 Subnetting Example: Before Subnetting

You can “borrow” one of the host ID bits to divide the network 192.168.1.0 into two separate sub-networks. The subnet mask is now 25 bits (255.255.255.128 or /25).

The “borrowed” host ID bit can have a value of either 0 or 1, allowing two subnets; 192.168.1.0 /25 and 192.168.1.128 /25.

The following figure shows the company network after subnetting. There are now two sub-networks, **A** and **B**.

Figure 119 Subnetting Example: After Subnetting

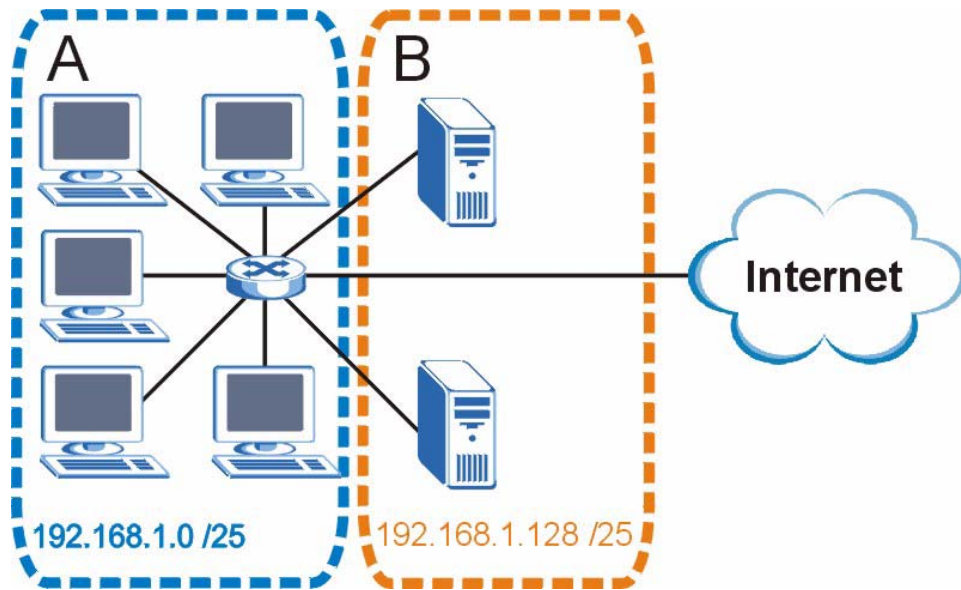

In a 25-bit subnet the host ID has 7 bits, so each sub-network has a maximum of $2^7 - 2$ or 126 possible hosts (a host ID of all zeroes is the subnet's address itself, all ones is the subnet's broadcast address).

192.168.1.0 with mask 255.255.255.128 is subnet **A** itself, and 192.168.1.127 with mask 255.255.255.128 is its broadcast address. Therefore, the lowest IP address that can be assigned to an actual host for subnet **A** is 192.168.1.1 and the highest is 192.168.1.126.

Similarly, the host ID range for subnet **B** is 192.168.1.129 to 192.168.1.254.

Example: Four Subnets

The previous example illustrated using a 25-bit subnet mask to divide a 24-bit address into two subnets. Similarly, to divide a 24-bit address into four subnets, you need to “borrow” two host ID bits to give four possible combinations (00, 01, 10 and 11). The subnet mask is 26 bits (11111111.11111111.11111111.11000000) or 255.255.255.192.

Each subnet contains 6 host ID bits, giving $2^6 - 2$ or 62 hosts for each subnet (a host ID of all zeroes is the subnet itself, all ones is the subnet's broadcast address).

Table 88 Subnet 1

IP/SUBNET MASK	NETWORK NUMBER	LAST OCTET BIT VALUE
IP Address (Decimal)	192.168.1.	0
IP Address (Binary)	11000000.10101000.00000001.	00000000
Subnet Mask (Binary)	11111111.11111111.11111111.	11000000

Table 88 Subnet 1 (continued)

IP/SUBNET MASK	NETWORK NUMBER	LAST OCTET BIT VALUE
Subnet Address: 192.168.1.0	Lowest Host ID: 192.168.1.1	
Broadcast Address: 192.168.1.63	Highest Host ID: 192.168.1.62	

Table 89 Subnet 2

IP/SUBNET MASK	NETWORK NUMBER	LAST OCTET BIT VALUE
IP Address	192.168.1.	64
IP Address (Binary)	11000000.10101000.00000001.	01000000
Subnet Mask (Binary)	11111111.11111111.11111111.	11000000
Subnet Address: 192.168.1.64	Lowest Host ID: 192.168.1.65	
Broadcast Address: 192.168.1.127	Highest Host ID: 192.168.1.126	

Table 90 Subnet 3

IP/SUBNET MASK	NETWORK NUMBER	LAST OCTET BIT VALUE
IP Address	192.168.1.	128
IP Address (Binary)	11000000.10101000.00000001.	10000000
Subnet Mask (Binary)	11111111.11111111.11111111.	11000000
Subnet Address: 192.168.1.128	Lowest Host ID: 192.168.1.129	
Broadcast Address: 192.168.1.191	Highest Host ID: 192.168.1.190	

Table 91 Subnet 4

IP/SUBNET MASK	NETWORK NUMBER	LAST OCTET BIT VALUE
IP Address	192.168.1.	192
IP Address (Binary)	11000000.10101000.00000001.	11000000
Subnet Mask (Binary)	11111111.11111111.11111111.	11000000
Subnet Address: 192.168.1.192	Lowest Host ID: 192.168.1.193	
Broadcast Address: 192.168.1.255	Highest Host ID: 192.168.1.254	

Example: Eight Subnets

Similarly, use a 27-bit mask to create eight subnets (000, 001, 010, 011, 100, 101, 110 and 111).

The following table shows IP address last octet values for each subnet.

Table 92 Eight Subnets

SUBNET	SUBNET ADDRESS	FIRST ADDRESS	LAST ADDRESS	BROADCAST ADDRESS
1	0	1	30	31
2	32	33	62	63
3	64	65	94	95
4	96	97	126	127
5	128	129	158	159
6	160	161	190	191
7	192	193	222	223
8	224	225	254	255

Subnet Planning

The following table is a summary for subnet planning on a network with a 24-bit network number.

Table 93 24-bit Network Number Subnet Planning

NO. "BORROWED" HOST BITS	SUBNET MASK	NO. SUBNETS	NO. HOSTS PER SUBNET
1	255.255.255.128 (/25)	2	126
2	255.255.255.192 (/26)	4	62
3	255.255.255.224 (/27)	8	30
4	255.255.255.240 (/28)	16	14
5	255.255.255.248 (/29)	32	6
6	255.255.255.252 (/30)	64	2
7	255.255.255.254 (/31)	128	1

The following table is a summary for subnet planning on a network with a 16-bit network number.

Table 94 16-bit Network Number Subnet Planning

NO. "BORROWED" HOST BITS	SUBNET MASK	NO. SUBNETS	NO. HOSTS PER SUBNET
1	255.255.128.0 (/17)	2	32766
2	255.255.192.0 (/18)	4	16382
3	255.255.224.0 (/19)	8	8190
4	255.255.240.0 (/20)	16	4094
5	255.255.248.0 (/21)	32	2046
6	255.255.252.0 (/22)	64	1022
7	255.255.254.0 (/23)	128	510
8	255.255.255.0 (/24)	256	254
9	255.255.255.128 (/25)	512	126
10	255.255.255.192 (/26)	1024	62
11	255.255.255.224 (/27)	2048	30
12	255.255.255.240 (/28)	4096	14
13	255.255.255.248 (/29)	8192	6
14	255.255.255.252 (/30)	16384	2
15	255.255.255.254 (/31)	32768	1

Configuring IP Addresses

Where you obtain your network number depends on your particular situation. If the ISP or your network administrator assigns you a block of registered IP addresses, follow their instructions in selecting the IP addresses and the subnet mask.

If the ISP did not explicitly give you an IP network number, then most likely you have a single user account and the ISP will assign you a dynamic IP address when the connection is established. If this is the case, it is recommended that you select a network number from 192.168.0.0 to 192.168.255.0. The Internet Assigned Number Authority (IANA) reserved this block of addresses specifically for private use; please do not use any other number unless you are told otherwise. You must also enable Network Address Translation (NAT) on the ES-2108/ES-2108-G.

Once you have decided on the network number, pick an IP address for your ES-2108/ES-2108-G that is easy to remember (for instance, 192.168.1.1) but make sure that no other device on your network is using that IP address.

The subnet mask specifies the network number portion of an IP address. Your ES-2108/ES-2108-G will compute the subnet mask automatically based on the IP address that you entered. You don't need to change the subnet mask computed by the ES-2108/ES-2108-G unless you are instructed to do otherwise.

Private IP Addresses

Every machine on the Internet must have a unique address. If your networks are isolated from the Internet (running only between two branch offices, for example) you can assign any IP addresses to the hosts without problems. However, the Internet Assigned Numbers Authority (IANA) has reserved the following three blocks of IP addresses specifically for private networks:

- 10.0.0.0 — 10.255.255.255
- 172.16.0.0 — 172.31.255.255
- 192.168.0.0 — 192.168.255.255

You can obtain your IP address from the IANA, from an ISP, or it can be assigned from a private network. If you belong to a small organization and your Internet access is through an ISP, the ISP can provide you with the Internet addresses for your local networks. On the other hand, if you are part of a much larger organization, you should consult your network administrator for the appropriate IP addresses.

Regardless of your particular situation, do not create an arbitrary IP address; always follow the guidelines above. For more information on address assignment, please refer to RFC 1597, *Address Allocation for Private Internets* and RFC 1466, *Guidelines for Management of IP Address Space*.

Index

Symbols

“standby” ports [113](#)

Numerics

802.1P priority [82](#)

A

access control [151](#)
 limitation [151](#)
 login account [154](#)
 remote management [162](#)
 service port [161](#)
 SNMP [152](#)

accounts
 and modes [186](#)
 creating with web configurator [56](#)

Address Resolution Protocol (ARP) [179](#), [181](#)

administrator password [155](#)

aggregator ID [114](#), [115](#)

aging time [76](#)

alternative subnet mask notation [264](#)

applications
 backbone [34](#)
 bridging [35](#)
 IEEE 802.1Q VLAN [36](#)
 switched workgroup [35](#)

ARP [179](#)
 how it works [179](#)
 view [179](#)

authentication
 and ports [33](#)

automatic VLAN registration [84](#)

B

basic settings [71](#)
 block from accessing [57](#)
 BPDUs [102](#)

Bridge Protocol Data Units (BPDUs) [102](#)
 Bridge Protocol Data Units, See BPDUs [102](#)
 broadcast storm control [109](#)

C

certifications [4](#)
 viewing [4](#)

CFI (Canonical Format Indicator) [83](#)

changing password [56](#)

Class of Service (CoS) [141](#)

CLI
 syntax conventions [184](#)

cloning a port See port cloning

cluster management [33](#), [171](#)
 manager [171](#), [175](#)
 member [171](#), [175](#)
 member firmware upgrade [173](#)
 network example [171](#)
 setup [174](#)
 specification [171](#)
 status [172](#)
 switch models [171](#)
 VID [175](#)
 web configurator [173](#)

Command Line Interface
 accessing [183](#)
 introduction [183](#)

Command Line Interface (CLI) [183](#)

commands [183](#)
 accessing [183](#)
 and configuration file [189](#)
 and interfaces [206](#)
 and multicasting [210](#)
 and passwords [185](#)
 configuration mode details [196](#)
 configure tagged VLAN example [239](#)
 enable mode details [191](#)
 exit [190](#)
 forwarding process example [243](#)
 getting help [187](#)
 logging in [184](#)
 modes [186](#)
 modes summary [186](#)
 mvr mode details [210](#)
 static VLAN table example [243](#)
 summary [190](#)

- syntax conventions [184](#)
- user mode details [190](#)
- using history [189](#)
- vlan mode details [209](#)
- commands interface mode details [206](#)
- configuration
 - restore [57](#)
 - saving [56](#), [189](#)
- configuration file [57](#), [189](#)
 - and commands [189](#)
 - backup [148](#)
 - restore [57](#), [147](#)
- configuration, default [57](#)
- console port [34](#)
 - commands [183](#)
 - reset [58](#)
 - settings [45](#), [183](#)
- copying port settings, See port cloning
- copyright [3](#)
- CPU management port [91](#)
- CRC (Cyclic Redundant Check) [69](#)
- current date [75](#)
- current time [75](#)

D

- debug mode [58](#)
- default configuration [57](#)
- DHCP [32](#)
- DHCP (Dynamic Host Configuration Protocol) [32](#)
- diagnostics [165](#)
 - ethernet port test [165](#)
 - ping [165](#)
 - system log [165](#)
- Differentiated Services (DiffServ) [141](#)
- Differentiated Services, See DiffServ [32](#)
- DiffServ [141](#)
 - activate [142](#)
 - DS field [141](#)
 - DSCP [141](#)
 - DSCP-to-IEEE802.1p mapping [143](#)
 - network example [141](#)
 - PHB [141](#)
- DiffServ (Differentiated Services) [32](#)
- disclaimer [3](#)
- DS field (Differentiated Services field) [141](#)
- DSCP [141](#)
 - DSCP-to-IEEE802.1p mapping [143](#)
 - service level [141](#)
 - what it does [141](#)
- dynamic link aggregation [113](#)

E

- egress port [93](#)
- Ethernet broadcast address [179](#)
- Ethernet port test [165](#)
- Ethernet ports [45](#)
 - default settings [45](#)
- extended authentication protocol [117](#)
- external authentication server [117](#)

F

- factory-defaults [57](#)
- FCC interference statement [4](#)
- features
 - hardware [33](#)
- file transfer using FTP
 - command example [149](#)
- filename convention [149](#)
- filtering [99](#)
 - rules [99](#)
- filtering database [177](#)
- firmware
 - upgrade [147](#), [173](#)
 - version [72](#)
- flow control [82](#)
 - back pressure [82](#)
 - IEEE802.3x [82](#)
- front panel [43](#)
- FTP [148](#)
 - file transfer procedure [149](#)
 - restrictions over WAN [150](#)

G

- GARP [84](#)
- GARP (Generic Attribute Registration Protocol) [84](#)
- GARP status [240](#)
- GARP terminology [84](#)
- GARP timer [76](#), [84](#)
- general setup [73](#)
- getting help [58](#)
- GMT (Greenwich Mean Time) [75](#)
- GVRP [84](#), [90](#)
- GVRP (GARP VLAN Registration Protocol) [84](#), [234](#)
- GVRP status [241](#)

H

- hardware [39](#)
 - by model [43](#)
 - freestanding installation [39](#)
 - front panel [43](#)
 - mounting brackets [40](#)
 - overview [43](#)
 - power connector [48](#)
 - precautions [40](#)
 - rack-mounting [40](#)
 - rubber feet [39](#)
 - transceiver installation [46](#)
 - transceiver removal [47](#)
 - ventilation [39](#)
 - wall-mounting [41](#)
- hardware installation [39](#)
 - freestanding [39](#)
 - precautions [40](#)
 - rack-mounting [40](#)
 - wall-mounting [41](#)
- help
 - in command interpreter [187](#)
- help, web configurator [58](#)
- history
 - in command interpreter [189](#)
- HTTPS [158](#)
 - example [159](#)

I

- IANA [270](#)
- IEEE 802.1p [77](#)
- IEEE 802.1x [117](#)
 - activate [119](#)
 - reauthentication [120](#)
- IEEE 802.1x, port authentication [117](#)
- IGMP
 - version [127](#)
- IGMP (Internet Group Multicast Protocol) [127](#)
- IGMP filtering [127](#)
 - profile [130](#)
 - profiles [129](#)
- IGMP snooping [127](#)
 - MVR [132](#)
- ingress port [93](#)
- installation, See hardware installation
- Internet Assigned Numbers AuthoritySee IANA [270](#)
- introduction [31](#)
- IP address
 - default [51](#)
- IP interface [78](#)

- IP setup [77](#)
- iStacking [33](#)

L

- LACP [113](#)
 - system priority [115](#)
 - timeout [116](#)
- LEDs [48](#)
- Link Aggregate Control Protocol (LACP) [113](#)
- link aggregation [33](#), [113](#)
 - dynamic [113](#)
 - ID information [114](#)
 - setup [115](#)
 - status [114](#)
- lockout [57](#)
- login [51](#)
 - account [154](#)
 - administrator account [154](#)
 - non-administrator account [154](#)
 - number of accounts [154](#)
 - password [56](#), [155](#)
- logs [165](#)

M

- MAC (Media Access Control) [72](#)
- MAC address [72](#), [179](#)
 - learning [76](#), [121](#), [122](#)
 - learning limit [122](#)
 - maximum number per port [122](#)
 - static [121](#)
- MAC address learning [33](#), [95](#)
- MAC table [177](#)
 - how it works [177](#)
 - view [178](#)
- maintenance [145](#)
- Management Information Base (MIB) [152](#)
- management interface, See also CLI
- management port [93](#)
- MIB [152](#)
 - supported MIBs [153](#)
- mini GBIC ports [45](#), [46](#)
 - connection speed [46](#)
 - connector type [46](#)
 - transceiver installation [46](#)
 - transceiver removal [47](#)
- mini-GBIC port [45](#)
- mirror port [111](#)

mirroring [32](#)
modes
 and accounts [186](#)
 in command interpreter [186](#)
mounting brackets [40](#)
MSA (MultiSource Agreement) [45, 46](#)
MTU (Multi-Tenant Unit) [75](#)
multicast [127](#)
multicast group [130](#)
multicast settings [129](#)
multicast VLAN [135](#)
multicasting
 802.1 priority [129](#)
 addresses [127](#)
 setup [128](#)
MVR [132](#)
 configuration [133](#)
 configuration example [137](#)
 group configuration [135](#)
 how it works [133](#)
 modes [132](#)
 network example [132](#)
 ports [132](#)
MVR (Multicast VLAN Registration) [132](#)

N

NAT [269](#)
navigation [54](#)
navigation panel [53](#)
Network Management System (NMS) [152](#)
NTP (RFC-1305) [75](#)

O

overview [31](#)

P

password [56](#)
 changing [56](#)
password, cluster member [176](#)
PHB (Per-Hop Behavior) [141](#)
ping [165](#)
port authentication [33, 117](#)
 IEEE802.1x [119](#)

 RADIUS server [119](#)
port cloning [181](#)
 advanced settings [181](#)
 basic settings [181](#)
port details [65](#)
port isolation [90, 93](#)
port mirroring [32, 111, 207](#)
 and commands [233](#)
port redundancy [113](#)
port security [33, 121](#)
 limit MAC address learning [122](#)
port setup [80](#)
port speed/duplex [82](#)
port status [63](#)
port VID
 default for all ports [207](#)
port VLAN trunking [85](#)
port-based VLAN [76, 91](#)
 all connected [93](#)
 port isolation [93](#)
 setting wizard [93](#)
ports
 “standby” [113](#)
 and MVR [132](#)
 details [45](#)
power connector [48](#)
priority [77](#)
priority level [77](#)
priority queue assignment [77](#)
product registration [8](#)
product specification [257](#)
PVID [83, 90](#)
PVID (Priority Frame) [83](#)

Q

queue weight [126](#)
queuing [32, 125](#)
queuing algorithm [125, 126](#)
queuing method [125, 126](#)

R

rack-mounting [40](#)
RADIUS [117](#)
 advantages [117](#)
 network example [117](#)
 server [117](#)

- settings [119](#)
- RADIUS (Remote Authentication Dial In User Service) [117](#)
- RADIUS server
 - setup [119](#)
- Rapid STP, See STP [33](#)
- rear panel [48](#)
- registration
 - product [8](#)
- related documentation [29](#)
- reload, default [57](#)
- remote management [162](#)
 - service [163](#)
 - trusted computers [163](#)
- reset [57](#)
- reset to factory default settings [146](#)
- restore configuration [57](#)
- RFC 3164 [167](#)
- RFC 3580 [118](#)
- Round Robin Scheduling [125](#)
- RSTP (Rapid STP), See also STP [33](#)
- rubber feet [39](#)

S

- safety warnings [6](#)
- saving configuration [56](#)
- security
 - and ports [33](#)
- service access control [161](#)
 - service port [162](#)
- Simple Network Management Protocol (SNMP) [152](#)
- SNMP [152](#)
 - agent [152](#)
 - communities [154](#)
 - management model [152](#)
 - manager [152](#)
 - MIB [152](#), [153](#)
 - network components [152](#)
 - object variables [152](#)
 - protocol operations [152](#)
 - setup [153](#)
 - traps [153](#)
 - versions supported [152](#)
- SNMP traps [153](#)
- software features [31](#)
- Spanning Tree Protocol, See STP [33](#)
- SPQ (Strict Priority Queuing) [125](#)
- SSH [155](#)
 - how it works [156](#)
 - implementation [157](#)
- standby ports [113](#)
- static MAC address [33](#), [95](#), [121](#)
- static MAC forwarding [95](#)
- static VLAN [87](#)
 - control [88](#)
 - tagging [88](#)
- status [52](#)
 - LED [48](#)
 - link aggregation [114](#)
 - port details [65](#)
 - ports [63](#)
 - STP [102](#)
 - VLAN [86](#)
- STP [101](#)
 - bridge ID [103](#)
 - bridge priority [104](#)
 - configuration [104](#)
 - designated bridge [102](#)
 - forwarding delay [105](#)
 - Hello BPDU [102](#)
 - Hello Time [103](#), [104](#)
 - how it works [102](#)
 - Max Age [103](#), [105](#)
 - path cost [101](#), [105](#)
 - port priority [105](#)
 - port state [102](#)
 - root port [102](#)
 - status [102](#)
 - terminology [101](#)
- STP (Spanning Tree Protocol) [33](#)
- Strict Priority Queuing (SPQ) [125](#)
- subnet [261](#)
- subnet mask [262](#)
- subnetting [264](#)
- switch lockout [57](#)
- switch reset [57](#)
- switch setup [76](#)
- syntax conventions [29](#)
- sys commands
 - examples [213](#), [222](#)
- sys log disp [222](#)
- sys sw mac list [215](#)
- syslog [167](#)
 - protocol [167](#)
 - server setup [168](#)
 - settings [167](#)
 - setup [167](#)
 - severity levels [167](#)
- system information [71](#)
- system log [165](#)
- system reboot [147](#)

T

tagged VLAN [83](#)

Telnet

- commands [184](#)
- logging in [184](#)
- management [184](#)

time

- current [75](#)
- time zone [75](#)
- timeserver [75](#)

Time (RFC-868) [75](#)

time service protocol [75](#)

- time format [75](#)

time zone [75](#)

timeserver [75](#)

trademarks [3](#)

traffic priority [77](#)

transceiver

- installation [46](#)
- removal [47](#)

traps

- destination [154](#)

traps, SNMP [153](#)

trunk group [113](#)

trunking [33](#), [113](#)

tunnel protocol attribute [118](#)

Type of Service (ToS) [141](#)

U

UTC (Universal Time Coordinated) [75](#)

V

Vendor Specific Attribute See VSA

ventilation [39](#)

ventilation holes [39](#)

version

- viewing [72](#)

VID [79](#), [83](#), [86](#), [87](#)

- number of possible VIDs [83](#)
- priority frame [83](#)

VID (VLAN Identifier) [83](#)

VLAN [75](#), [83](#)

- acceptable frame type [90](#)
- all connected [93](#)
- automatic registration [84](#)

ID [83](#)

ingress filtering [90](#)

introduction [75](#)

number of VLANs [86](#)

port isolation [90](#)

port number [87](#)

port settings [89](#)

port-based [76](#)

port-based VLAN [91](#)

static VLAN [87](#)

status [86](#), [87](#)

tagged [83](#)

trunking [85](#)

type [76](#), [85](#)

VLAN (Virtual Local Area Network) [32](#), [75](#)

VLAN number [79](#)

VLAN trunking [91](#)

vlan1q port accept [242](#)

vlan1q port gvrp [242](#)

vlan1q svlan active [244](#)

vlan1q svlan delentry [244](#)

vlan1q svlan inactive [245](#)

vlan1q svlan list [245](#)

vlan1q svlan setentry [220](#), [247](#)

VSA [117](#)

W

wall-mounting [41](#)

warnings [6](#)

warranty [8](#)

- note [8](#)

web configurator

- default IP address [51](#)

features [54](#)

getting help [58](#)

home [52](#)

lockout [57](#)

login [51](#)

logout [58](#)

navigation panel [53](#)

screen summary [54](#)

status [52](#)

system information [71](#)

Weighted Round Robin, See WRR [32](#)

WRR [125](#)

WRR (Weighted Round Robin) [32](#)

Z

ZyNOS (ZyXEL Network Operating System) [149](#)